

Journal of the Royal Microscopical Society

CONTAINING ITS TRANSACTIONS AND PROCEEDINGS

AND

A SUMMARY OF CURRENT RESEARCHES RELATING TO
ZOOLOGY AND BOTANY

(principally Invertebrata and Cryptogamia)

MICROSCOPY, &c.

EDITED BY

R. G. HEBB, M.A. M.D. F.R.C.P.

WITH THE ASSISTANCE OF THE PUBLICATION COMMITTEE AND

J. ARTHUR THOMSON, M.A. F.R.S.E.

A. N. DISNEY, M.A. B.Sc.

*Regius Professor of Natural History in the
University of Aberdeen*

FELLOWS OF THE SOCIETY

AND

A. B. RENDLE, M.A. D.Sc. F.R.S. F.L.S.

Keeper, Department of Botany, British Museum

HAROLD MOORE, B.Sc.

Woolwich Arsenal

G. H. K. MACALISTER, M.A. M.D. (CANTAB.)

Assistant Bacteriologist Lister Institute

Minimis partibus, per totum Naturæ campum, certitudo omnis innititur
quas qui fugit pariter Naturam fugit.—*Linnaeus*.

FOR THE YEAR

1910



TO BE OBTAINED AT THE SOCIETY'S ROOMS,

26 HANOVER SQUARE, LONDON, W.

OF MESSRS. WILLIAMS & NORGATE, 14 HENRIETTA STREET, LONDON, W.C.

AND OF MESSRS. DULAU & CO., 37 SOHO SQUARE, LONDON, W.

Extra and informal Meetings are held on the 1st and 4th Wednesday evenings of the month. These Meetings are devoted to:—(1) Biology, Bacteriology, and Histology; (2) Microscopical Optics and Microscope Construction.

THE

Royal Microscopical Society.

Established in 1839. Incorporated by Royal Charter in 1866.

The Society was established for the promotion of Microscopical and Biological Science by the communication, discussion, and publication of observations and discoveries relating to (1) improvements in the construction and mode of application of the Microscope, or (2) Biological or other subjects of Microscopical Research.

It consists of Ordinary, Honorary, and Ex-officio Fellows of either sex.

Ordinary Fellows are elected on a Certificate of Recommendation signed by three Ordinary Fellows, setting forth the names, residence, and description of the Candidate, of whom the first proposer must have personal knowledge. The certificate is read at two General Meetings, and the Candidate balloted for at the second Meeting.

The Admission Fee is 2*l.* 2*s.*; and the Annual Subscription 2*l.* 2*s.*, payable on election, and subsequently in advance on 1st January annually. The Annual Subscriptions may be compounded for at any time for 3*l.* 10*s.* Fellows elected at a meeting subsequent to that in February are only called upon for a proportionate part of the first year's subscription. The annual Subscription of Fellows permanently residing abroad is 1*l.* 11*s.* 6*d.* or a reduction of one-fourth.

Honorary Fellows (limited to 50), consisting of persons eminent in Microscopical or Biological Science, are elected on the recommendation of five Ordinary Fellows and the approval of the Council.

Ex-officio Fellows (limited to 100), consisting of the Presidents for the time being of any Societies having objects in whole or in part similar to those of the Society, are elected on the recommendation of ten Ordinary Fellows and the approval of the Council.

The Council, in whom the management of the property and affairs of the Society is vested, is elected annually, and is composed of the President, four Vice-Presidents, Treasurer, two Secretaries, and twelve other Ordinary Fellows.

The Meetings are held on the third Wednesday in each month, from October to June, at 20 Hanover Square, W. (commencing at 8 P.M.). Visitors are admitted by the introduction of Fellows. (See preceding page.)

The Journal, containing the Transactions and Proceedings of the Society, and a Summary of Current Researches relating to Zoology and Botany (principally Invertebrata and Cryptogamia), Microscopy, &c., is published bi-monthly, and is forwarded post-free to all Ordinary and Ex-officio Fellows residing in countries within the Postal Union.

The Library, with the Instruments, Apparatus, and Cabinet of Objects, is open for the use of Fellows daily (except Saturdays), from 10 A.M. to 5 P.M. It is closed for four weeks during August and September.

Forms of proposal for Fellowship, and any further information, may be obtained by application to the Secretaries, or Assistant-Secretary, at the Library of the Society, 20 Hanover Square, W.

Patron

HIS MAJESTY THE KING.

Past-Presidents.

	Elected
*SIR RICHARD OWEN, K.C.B. D.C.L. M.D. LL.D. F.R.S.	1840-1
*JOHN LINDLEY, Ph.D. F.R.S.	1842-3
*THOMAS BELL, F.R.S.	1844-5
*JAMES SCOTT BOWERBANK, LL.D. F.R.S.	1846-7
*GEORGE BUSK, F.R.S.	1848-9
*ARTHUR FARRE, M.D. F.R.S.	1850-1
*GEORGE JACKSON, M.R.C.S.	1852-3
*WILLIAM BENJAMIN CARPENTER, C.B. M.D. LL.D. F.R.S.	1854-5
*GEORGE SHADBOLT	1856-7
*EDWIN LANKESTER, M.D. LL.D. F.R.S.	1858-9
*JOHN THOMAS QUEKETT, F.R.S.	1860
*ROBERT JAMES FARRANTS, F.R.C.S.	1861-2
*CHARLES BROOKE, M.A. F.R.S.	1863-4
*JAMES GLAISHER, F.R.S.	1865-6-7-8
*REV. JOSEPH BANCROFT READE, M.A. F.R.S.	1869-70
*WILLIAM KITCHEN PARKER, F.R.S.	1871-2
*CHARLES BROOKE, M.A. F.R.S.	1873-4
*HENRY CLIFTON SORBY, LL.D. F.R.S.	1875-6-7
*HENRY JAMES SLACK, F.G.S.	1878
*LIONEL S. BEALE, M.B. F.R.C.P. F.R.S.	1879-80
*PETER MARTIN DUNCAN, M.B. F.R.S.	1881-2-3
*REV. WILLIAM HY. DALLINGER, M.A. LL.D. F.R.S.	1884-5-6-7
*CHARLES THOS. HUDSON, M.A. LL.D. (Cantab.), F.R.S.	1888-9-90
ROBERT BRAITHWAITE, M.D. M.R.C.S.	1891-2
ALBERT D. MICHAEL, F.L.S.	1893-4-5-6
EDWARD MILLES NELSON	1897-8-9
WILLIAM CARRUTHERS, F.R.S. F.L.S. F.G.S.	1900-1
HENRY WOODWARD, LL.D. F.R.S. F.G.S. F.Z.S.	1902-3
DUKINFIELD HY. SCOTT, M.A. Ph.D. LL.D. F.R.S. F.L.S.	1904-5-6
THE RIGHT HON. LORD AVEBURY, P.C. D.C.L. LL.D.	
F.R.S., etc.	1907-8
SIR EDWIN RAY LANKESTER, K.C.B. M.A. LL.D. F.R.S.	
F.L.S. F.Z.S.	1909-10

* Deceased

COUNCIL.

ELECTED 19TH JANUARY, 1910.

President.

J. ARTHUR THOMSON, M.A. F.R.S.E., Regius Professor of Natural History in the University of Aberdeen.

Vice-Presidents.

- *FREDERIC J. CHESHIRE.
- *A. N. DISNEY, M.A. B.Sc.
- J. W. H. EYRE, M.D. F.R.S.E.
- E. J. SPITTA, L.R.C.P. (Lond.), M.R.C.S. (Eng.).

Treasurer.

WYNNE E. BAXTER, J.P. D.L. F.G.S. F.R.G.S.

Secretaries.

- R. G. HEBB, M.A. M.D. F.R.C.P.
- *F. SHILLINGTON SCALES, M.A. M.B. B.C. (Cantab.)

Ordinary Members of Council.

- F. W. WATSON BAKER.
- J. E. BARNARD.
- E. HERON-ALLEN, F.L.S. F.Z.S. F.R.Met.Soc.
- C. F. HILL.
- JOHN HOPKINSON, F.L.S. F.Z.S. F.R.Met.Soc.
- HENRY GEORGE PLIMMER, F.R.S. F.L.S.
- THOMAS H. POWELL.
- PERCY E. RADLEY.
- *JULIUS RHEINBERG.
- *CHARLES F. ROUSSELET.
- D. J. SCOURFIELD, F.Z.S.
- W. WESCHÉ.

* Members of the Publication Committee.

LIBRARIAN.

PERCY E. RADLEY.

CURATORS.

- CHARLES F. ROUSSELET.
- F. SHILLINGTON SCALES, M.A. M.B. B.C. (Cantab.)

ASSISTANT SECRETARY.

F. A. PARSONS.

CONTENTS.

TRANSACTIONS OF THE SOCIETY.

	PAGE
I.—On the Microscopical Structure of an <i>Inoceramus</i> Limestone in the Queens-land Cretaceous Rocks. By Frederick Chapman, A.L.S. F.R.M.S. (Plate I.)	1
II.—On the Measurement of Grayson's Ten-band Plate. By A. A. C. Eliot Merlin	5
III.—An Automatic Aerating Apparatus, suitable for Aquaria, etc. By James F. Gemmill, M.A. M.D. (Fig. 1)	9
IV.—The President's Address. By Sir E. Ray Lankester	137
V.—Note on <i>Dendrobrachia fallax</i> Brook, a Rare and Remarkable Antipatharian. By Professor J. Arthur Thomson, M.A.	142
VI.—On the Measurement of the First Nine Groups of Grayson's Finest Twelve-band Plate. By A. A. C. Eliot Merlin	144
VII.—On the Visibility of the Tertiaries of <i>Coscinodiscus asteromphalus</i> in a Balsam Mount. By Edward M. Nelson	147
VIII.—Antipatharians from the Indian Ocean. By Sophia L. M. Summers, M.A. B.Sc. (Natural History Department, University of Aberdeen.) (Plate V.)	273
IX.—Critical Microscopy. By Edward M. Nelson. (Fig. 46)	282
X.—On the Measurement of the Diameter of the Flagella of the Cholera Bacillus prepared by Löffler's Method. By A. A. C. Eliot Merlin	290
XI.—On the Recent and Fossil Foraminifera of the Shore-sands of Selsey Bill, Sussex.—V. The Cretaceous Foraminifera. By Edward Heron-Allen, F.L.S., F.R.M.S., and Arthur Earland. (Plates VI.—XI.)	401
‡XII.—What did our Forefathers see in a Microscope? By Edward M. Nelson. (Fig. 52)	427
XIII.—Comparative Micrometric Measurements. By Dr. Marshall D. Ewell, Chicago, Illinois	537
‡XIV.— <i>Hicksonella</i> , a New Gorgonellid Genus. By James J. Simpson, M.A., B.Sc. (Carnegie Fellow, University of Aberdeen.) (Plate XIII.)	681
XV.—On the Recent and Fossil Foraminifera of the Shore-sands of Selsey Bill, Sussex.—VI. A Contribution towards the Ætiology of <i>Massilina secans</i> (d'Orbigny sp.). By Edward Heron-Allen, F.L.S., F.R.M.S., and Arthur Earland, F.R.M.S.	693
XVI.—A Micrometric Difficulty. By Edward M. Nelson. (Fig. 104)	696
XVII.—On the Resolution of New Detail in a <i>Coscinodiscus asteromphalus</i> . By Edward M. Nelson (Fig. 105)	698

NOTES.

	PAGE
Convenient Form of Stand for Use as a Micro-Colorimeter and with the Micro-Spectroscope. By Marshall D. Ewell, F.R.M.S. (Figs. 2-4)	14
Note on the Use of the Mercury Vapour Lamp in Observing the Rings and Brushes in Crystals. By E. B. Stringer	440
Grayson's Photomicrographs of his Rulings. By Edward M. Nelson. (Plate XIV.)	701

SUMMARY OF CURRENT RESEARCHES

RELATING TO ZOOLOGY AND BOTANY (PRINCIPALLY INVERTEBRATA AND CRYPTOGAMIA), MICROSCOPY, &c., INCLUDING ORIGINAL COMMUNICATIONS FROM FELLOWS AND OTHERS.* 17, 149, 293, 441, 555, 704

ZOOLOGY.

VERTEBRATA.

a. Embryology.

WINIWARTER, H. V., & G. SAINMONT—Structure of Mammalian Ovary	17
BOUIN, P., & P. ANCEL—Ovarian Glands	17
BROHMER, PAUL—Head of Embryo <i>Chlamydoselachus</i>	18
BORCEA, I.—Development of Heart in Teleosts	18
" Intermediary Mesodermic Mass in Teleost Embryos	18
BROOM, R.—Development of Marsupial Skull	18
MOLLIER, S.—Blood-formation in Embryonic Mammalian Liver	18
MARCUS, HARRY—Development of Head of <i>Gymnophiona</i>	19
YOUNGMAN, W.—Abnormal Reproductive Organs in Frog	19
GUYER, M. F.—Spermatogenesis of Fowl	19
FLEIG, C.—Vitality of Spermatozou	20
BARFURTH, D.—Hyperdactylism in Fowls	20
AGAR, W. E.—Embryonic Appendage of Claws of <i>Amniota</i>	149
THOMSON, J. ARTHUR—Study of Darwinism	149
KWIETNIEWSKI, CASIMIR—Development of Wolffian and Mullerian Ducts in Rodents	150
DISSE, J.—Development of Bone and Dentine	150
SÖDERLUND, G., & A. BACKMANN—Involution of Thymus in Rabbit	150
JOLLY, J., & A. CARRAN—Development of Lymphatic Ganglia in Mammals	150
COYLE, RAY F.—Development of Auditory Ossicles in Horse	150
PRICE-JONES, C.—Development of Red Blood Cells in Chick	151
POOLE, MARGARET—Development of Subdivisions of Pleuroperitoneal Cavity in Birds	151
BRÜNAUER, ERNA—Development of Vertebral Column in Grass Snail	151
HIRZEL, H.—Abortive Embryo of <i>Salamandra atra</i>	152
TARAPANI, HELENA—Development of Hyobranchial Skeleton in <i>Salamandra atra</i> and <i>Triton alpestris</i>	152
JANSENS, F. A., & J. WILLEMS—Spermatogenesis in <i>Alytes obstetricans</i>	152
GIBSON, W. T.—Hypochord in Skate Embryos	152
HATSCHKE, B.—Metameres of <i>Petromyzon</i>	152
LANE, H. H.—Placentation in Tatu	153
GATES, R. R.—Litter of Hybrid Dogs	153
DELAGE, YVES—Alleged Influence of Electric Discharges in Inducing Parthenogenesis	293
LÉCAILLON, A.—Vitelline Membrane in Egg of Birds	293
GUEYSSE-PELISSIER, A.—Polynuclear Ovum in Bat	294

* In order to make the Contents complete, the papers printed in the 'Transactions' and the Notes printed in the 'Proceedings' are entered here.

VAYSSIÈRE, A.— <i>Double Egg in Porbeagle Shark</i>	294
BAUMEISTER, L.— <i>Egg of Rhinophis</i>	294
DUESBERG, J.— <i>Mitochondrial Elements of Germ-cells and Chondriosomes of Embryonic Cells</i>	294
ABEL, WILLIAMINA— <i>Development of Autonomic Nervous Mechanism of Bird's Alimentary Canal</i>	294
JOLLY, J.— <i>Development of Lymphatic Ganglia of Duck</i>	294
KUNTZ, ALBERT— <i>Role of Vagi in Development of Sympathetic Nervous System</i> ..	295
PANSCHIN, B. A.— <i>Cranial Nerves of Pike</i>	295
KERR, J. GRAHAM— <i>Development of Alimentary Canal in Lepidosiren and Protopterus</i>	295
FUHRMANN, O.— <i>Hermaphroditism in Toads</i>	296
HART, D. BERRY— <i>Reproductive Organs of Free-Martin</i>	296
ACHARD, C. H., HENRI BÉNARD, & CH. GAGNEUX— <i>Leuco-reaction in Pregnancy</i> ..	296
LOISEL, GUSTAVE— <i>Influence of Male Parent in Heredity</i>	296
PEARL, RAYMOND, & FRANK M. SURFACE— <i>Use of Selection Index Numbers in Breeding</i>	296
RUSSO— <i>Determination of Sex</i>	441
FELLNER, O. O.— <i>State of Ovary during Pregnancy</i>	441
KOHLBRUGGE, J. H. F.— <i>Spermatozoa entering a Blastula</i>	442
MAXIMOW, A.— <i>Development of Blood</i>	442
HERTWIG, OSCAR— <i>Role of Nucleus in Heredity</i>	442
LÉCAILLON, A.— <i>Segmentation of Unfertilised Egg of Fowl</i>	442
WIDAKOWICH, VICTOR— <i>Early Stages in Development of Rat</i>	442
LOW, ALEX.— <i>Ossification of Human Lower Jaw</i>	443
TIMS, H. W. MARETT— <i>Seed-embryos</i>	443
BELOGOLOVY, J.— <i>Development of Cranial Nerves in Birds</i>	443
MEYER, ERNST— <i>Development of Blindworm</i>	443
MARÉCHAL, J., & A. DE SÆDELEER— <i>Oogenesis in Raiadæ</i>	443
GLÆSNER, L., & MARC DE SELYS-LONGCHAMPS— <i>Segmentation and Gastrulation in Lamprey</i>	443
LEGROS, ROBERT— <i>Development of Nephridium in Amphioxus</i>	443
PARIS, PAUL— <i>Hybridisation of Wolf and Dog</i>	444
GUYER, M. F.— <i>Plumage of Hybrids between Guinea-fowl and Fowl</i>	444
WATERSTON, D., & A. CAMPBELL GEDDES— <i>Development of Penguin</i>	444
PEARL, R., & F. M. SURFACE— <i>Fertility and Hatching of Eggs</i>	555
PEARL, R., & M. R. CURTIS— <i>Reproduction in the Domestic Fowl</i>	556
MIETENS, HARALD— <i>Origin of Blood in Toad</i>	556
GALLARDO, ANGEL— <i>Modern Study of Heredity</i>	557
GOGGIO, E.— <i>Experiments on Tadpoles</i>	557
MEVES, FR.— <i>Male Mitochondria in Fertilized Orum</i>	557
PRZIBRAM, H.— <i>Organogenetic Capacity</i>	704
WILSON, JAMES— <i>Inheritance of Quantity and Quality in Cow's Milk</i>	704
CUÉNOT, L., & L. MERCIER— <i>Heredity in Connection with Cancer</i>	705
GUTHRIE, C. C.— <i>Engrafting Tissues</i>	705
<i>Engrafting Gonads</i>	705
GUTHRIE, C. C., & CASTLE— <i>Guinea-pig Graft Hybrids</i>	705
BATAILLON, E.— <i>Artificial Parthenogenesis of Frog's Eggs</i>	706
DEHORNE, ARMAND— <i>Number of Chromosomes in Batrachians and in Parthenogenetic Embryos</i>	706
SOUTHWELL, T.— <i>Intra-uterine Embryos of Saw-fish</i>	706
DÜREN, B.— <i>Influence on Nervous System of Extirpation of Limb-primordia in Frog Embryos</i>	706
SUMNER, F. B.— <i>Somatic Modifications in White Mice, and their Reappearance in the Offspring</i>	706

b. Histology.

PICTET, A.— <i>Minute Structure of Food Canal in Cyprinoid Fishes</i>	20
REUTER, ENZIO— <i>New Mode of Nuclear Division</i>	20
DUSTIN, A. P.— <i>Thymus of Reptiles</i>	20
STECHE, O.— <i>Phosphorescent Organs of Fishes</i>	21

	PAGE
BOEKE, J.— <i>Motor End-plate in Higher Vertebrates</i>	153
TRAUTMANN, A.— <i>Musculature in Villi of Small Intestine</i>	153
ROULE, L.— <i>Epidermic Papillæ in Euproctus</i>	154
TRETJAKOFF, D., & J. BELOGOLOWY— <i>Study of Nervous Systems</i>	154
MULLENIX, R. C.— <i>Peripheral Terminations of Eighth Cranial Nerve</i>	154
GEMELLI, AGOSTINO— <i>Innervation of Tympanum</i>	154
CRAWLEY, HOWARD— <i>Mammalian Blood Studied with Dark-field Illumination</i> ..	154
GRÉGOIRE, V.— <i>Phenomena of Synaptic Phase</i>	154
MISLAWSKY, A. N.— <i>Vesicular Secretion</i>	155
PATON, MONTGOMERY P.— <i>Junction of Papillary Muscle and Chordæ Tendineæ</i> ..	155
HUE, L. H.— <i>Mast-cells and Plasma-cells</i>	155
CARLIER, E. WACE— <i>Changes in Nuclei in Varying Physiological Conditions</i> ..	155
RETTNER, E., & A. LELIÈVRE— <i>Mammalian Red Blood Corpuscles</i>	297
SCHMIDT, W. J.— <i>Integument of Voeltzkowia mira</i>	297
HULMANICKA, R.— <i>Nerve-endings in Frog's Skin</i>	297
GLAESER, K.— <i>Cartilage of Regenerated Amphibian Extremities</i>	297
ZIMMERMANN, K. W., & OTHERS— <i>Structure of Heart Muscle</i>	297
MEVES, F.— <i>Structure of Embryonic Supporting Tissue and Origin of Connective-tissue Fibrils</i>	298
STAUFFACHER, H.— <i>Nuclear Structure</i>	444
KNOLL, W.— <i>Relations of Nucleus and Cytoplasm</i>	444
GALLARDO, ANGEL— <i>Theory of Cell-division</i>	445
GORGORZA, J.— <i>Skin of Pleurodeles</i>	445
LELIÈVRE, AUG., & ED. RETTNER— <i>Mucous Epithelium</i>	445
NOWIN, N.— <i>Tractile-cells of Grandry's Corpuscles</i>	445
OKAJIMA, K.— <i>Sensory Organs of Onychodactylus</i>	445
SMALLWOOD, W. M., & C. G. ROGERS— <i>Graules in Nerve-cells</i>	445
LEGENDRE, R.— <i>Internal Reticulum in Ganglion-cells</i>	446
FREIDSOHN, A.— <i>Blood of Amphibians</i>	446
ARNOLD, J.— <i>Glycogen of Muscle</i>	446
RENAUT, J., & C. DUBREUIL— <i>Hyaline Cartilage in Mammals</i>	446
LUBOSCH, W.— <i>Calcification of Selachian Cartilage</i>	446
ILLING, G.— <i>Minute Structure of Tonsils</i>	446
UTORE, G.— <i>Glands in Gall-bladder of Dog</i>	447
JONSON, ARVID— <i>Degeneration and Regeneration of Thymus in Modified Nutritive Conditions</i>	447
HEINRICH, O.— <i>Development of Dentine in Mammals</i>	557
KINEL, JAN— <i>Regeneration of Bone in Birds</i>	557
MAYER, ANDRÉ, & OTHERS— <i>Mitochondria of Hepatic Cell</i>	558
PARDI, F.— <i>Clasmatocytes</i>	558
HEIDERICH, FR.— <i>Visible Centrosomes in Living Cells</i>	558
ALEZAIS & PEYRON— <i>Nucleated Red Blood Corpuscles in Blood-vessels of the Hypophysis</i>	707
RETTNER, E., & A. LELIÈVRE— <i>Red Blood Corpuscles of Mammals</i>	708
JOLLY, J.— <i>Life of Isolated Cells</i>	708
CHATIN, J.— <i>Structure of Sclerotic</i>	708
SCHAFFER, JOSEF— <i>Chordoid Tissue</i>	708
NOWIKOFF, M.— <i>Structure of Bone in Sunfish</i>	708
BETHE, ALBRECHT— <i>Function of Neurofibrils</i>	709
HOEHE, L.— <i>Affinities of Mammary Glands</i>	709
HOVEN, H.— <i>Role of Chondriome in Secretion</i>	709
ALEZAIS & PEYRON— <i>Process of Secretion in Human Hypophysis</i>	709
RETTNER, ED., & AUG. LELIÈVRE— <i>Peyer's Patches in Birds</i>	709
LELIÈVRE, AUG., & ED. RETTNER— <i>Nature of the Bursa Fabricii</i>	709

c. General.

CLELAND, J. BURTON— <i>Diurnal Variations in Temperatures of Camels</i>	22
BILLARD, G.— <i>Immunity of Lerot to Viper's Poison</i>	22
POCOCK, R. I.— <i>Colours of Equidæ</i>	22
SEABRA, A. F. DE— <i>Albinism</i>	23

	PAGE
JAMESON, H. LYSTER— <i>Struggle for Existence among South African Rats</i>	23
PEARL, RAYMOND, & MAUD DEWITT PEARL— <i>Variation in Comb of Domestic Fowl</i>	23
ROULE, LOUIS— <i>Variations in Tropidonotus</i>	23
ABEL, O.— <i>Attitude of Dinosaurs</i>	23
DEHAUT, G.— <i>Langless Salamandrid</i>	24
ATHANASIU, J., & J. DRAGOIU— <i>Seasonal Migration of Fat in the Frog</i>	24
DOLLO, L., & G. SCHLESINGER— <i>Studies on Fishes</i>	24
BROCHER, F.— <i>Capillary Phenomena in Life of Fresh-water Animals</i>	24
MORRIS, ESTHER R., & JANET RAFF— <i>Structure of Asymmetron bassanum Gunther</i>	25
SHIPLEY, A. E.— <i>Relation of Entozoa to Bacterial Disease</i>	25
MOORE, BENJAMIN— <i>Reaction of Marine Organisms to Light and Phosphorescence</i> ..	155
FUCHS, HUGO— <i>Temporal Region in Vertebrates</i>	157
FUCHS, HUGO, & ROY L. MOODIE— <i>Morphological Significance of Sacral Ribs</i> ..	157
USSOFF, S. A.— <i>Significance of the Entochorda</i>	157
ROULE, L.— <i>Study of the Notochord</i>	157
FRITZ, F.— <i>Vibrissæ on Cats' Arm</i>	157
PROUSSERT, E. L.— <i>New Insectivore</i>	157
POCOCK, R. I.— <i>Agriotype of Domestic Asses</i>	158
BROOM, R.— <i>Organ of Jacobson in Ant-bear</i>	158
LANE, H. H.— <i>Classification of Edentates</i>	158
HUET, R. H. J. G.— <i>Seminal Vesicles and Infection</i>	158
FRANÇOIS-FRANCK, CH. E.— <i>Mechanism of Respiration in Lizard</i>	158
MAYERHOFER, FRANZ— <i>Ribs of Urodela</i>	159
PELLEGRIN, J.— <i>New Parasitic Fish</i>	159
REGAN, C. TATE— <i>Species of Three-spined Sticklebacks</i>	159
BURNE, R. H.— <i>Aortic Ligament of Shad</i>	159
DOLLO, LOUIS— <i>Antarctic Macrurid</i>	159
ALLIS, EDWARD PHELPS— <i>Cranial Anatomy of Mail-cheeked Fishes</i>	160
LYOYD, R. E.— <i>Supposed Evidence of Mutation in Malthopsis</i>	160
TSCHERMAK, A. V.— <i>Study of Heart-action in Fish Embryos</i>	160
BURNE, R. H.— <i>Olfactory Organ of Teleosteans</i>	161
TRETJAKOFF, D.— <i>Mesencephalic Nerve in Annocætes</i>	161
FAGE, L.— <i>Variation in Mullet</i>	161
Ogilvie-Grant, W. R.— <i>Zoology of Ruwenzori</i>	161
MAYER, A. G.— <i>Relation between Ciliary and Muscular Movements</i>	298
WESTER, D. H.— <i>Distribution of Chitin</i>	298
LANNELONGUE— <i>Supplementary Function of Foot in Yellow Races</i>	298
GERHARDT, ULRICH— <i>Os Penis and Os Clitoris in Apes</i>	299
BRUNS, FANNY— <i>Nails of Primates</i>	299
EWART, J. COSSAR— <i>Restoration of Ancient British Race of Horses</i>	299
HOUSSAY, FREDERICK— <i>Asymmetry of Cetacean Skull</i>	299
CARLSSON, ALBERTINA— <i>Macroscelidæ</i>	299
LECHE, W.— <i>Significance of Milk Dentition</i>	299
CORY, CHARLES B.— <i>Birds of Illinois and Wisconsin</i>	300
HAGMANN, G.— <i>Reptiles of Mexiana</i>	300
MILLER, NEWTON— <i>Habits of American Toad</i>	300
WINTREBERT, P.— <i>Transformation of Palatal Region in Axolotl</i>	301
" " <i>Palatine and Pterygoid in Axolotl</i>	301
ENGEL, H.— <i>Rostral Teeth of Pristis</i>	301
HONY, REINHARD— <i>Suctorial Disc of Echeuis</i>	301
ELMHIRST, R.— <i>Notes from Millport Biological Station</i>	301
BIANCO, SALVATORE LO— <i>Period of Sexual Maturity in Marine Animals</i>	302
SCHARFF, R. F.— <i>Former Land Bridge between Northern Europe and North America</i>	302
GOODRICH, E. S.— <i>Origin of Vertebrata</i>	447
LORRAND, A.— <i>Physiology of Senescence</i>	447
FUCHS, H.— <i>Homologies of Mammalian Pterygoid</i>	447
CURTIS, MAYNIE R.— <i>Ligaments of Oviduct of Domestic Fowl</i>	447
WELCH, F. D.— <i>Change of Colour in a Ratel</i>	448
STRUBELL, ALEX.— <i>Immunity of Hedgehog</i>	448
BARBOUR, THOMAS— <i>Reptiles and Amphibians of Jamaica</i>	448
PHISALIX— <i>Toxic Action of Mucus of Amphibians</i>	448
AGAR, W. E.— <i>Nesting Habits of Phyllomedusa sauvagii</i>	448

	PAGE
O'DONOGHUE, CHAS. H.— <i>Abnormalities in Frog's Circulation</i>	449
AUDIGÉ, J.— <i>Kidney of Teleosts</i>	449
REGAN, C. TATE— <i>Caudal Fin of Elopidae and some other Teleosts</i>	449
GRYNFELDT, E.— <i>Tensor Muscle of Choroid in Teleosts</i>	449
GOODRICH, E. S.— <i>Segmental Structure of Motor Nerve Plexus in Elasmobranchs</i>	449
EVANS, WILLIAM— <i>Fauna of Forth Area</i>	450
DADAY, F. VON— <i>Fresh-water Microfauna of German East Africa</i>	450
MURRAY, JAMES— <i>Microscopic Fauna at Cape Roys</i>	450
ENTZ, GÉZA— <i>Mimicry</i>	558
PEARSE, A. S.— <i>Reactions of Amphibians to Light</i>	559
PEARL, R., & F. M. SURFACE— <i>Cumulative Effect of Selection</i>	560
CRAIG, W.— <i>Expressions of the Emotions in Pigeons</i>	561
REESE, A. M.— <i>Brain of American Alligator</i>	561
ROAF, H. E.— <i>Digestion in Marine Invertebrates</i>	561
NUTTING, C. C.— <i>Theory of Abyssal Light</i>	562
HERDMAN, W. A., & OTHERS— <i>Intensive Study of Plankton around South End of Isle of Man</i>	562
GOODEY, T.— <i>Vestiges of Thyroid in Chlamydoselachus and Dogfish</i>	562
ALLEN, E. J., & E. W. NELSON— <i>Rearing Murine Larvæ</i>	563
KELLER, C.— <i>Zoology of the Minotaur Myth</i>	563
ROSCHER, P.— <i>Mouth and Pharynx of Hamster</i>	564
GUITEL, FRÉDÉRIC— <i>Kidneys of Fishes</i>	564
MOŽEJKO, B.— <i>Venous System of the Lamprey</i>	564
BILLARD, G.— <i>Immunity of Lerot to Viper's Venom</i>	710
BUB, MAX— <i>Apparent Bactericidal Influence of Colostral Milk</i>	710
LÖNNBERG, EINAR— <i>Variation in Skull of Sea-elephants</i>	710
BEMMELEN, J. F. VAN— <i>Rabbit and Hare</i>	710
KAZZANDER, J.— <i>Hairs on Mole's Hands and Feet</i>	710
LÖWY, R.— <i>Double Gall Bladder in Cut</i>	711
STROHL, J.— <i>Adaptation of Ptarmigan to High Altitudes</i>	711
CHAPPELLIER, A.— <i>Peculiar Organ in Finches</i>	711
LAPICQUE, L., & J. PETETIN— <i>Neut without Lungs</i>	711
SOUTHWELL, T.— <i>Oyster-eating Fishes</i>	711
BURLEND, T. H.— <i>Urogenital Organs of <i>Chimæra monstrosa</i></i>	711
GOODEY, T.— <i>Skeleton of Frilled Shark</i>	712
ABEL, O.— <i>What is a Monstrosity?</i>	712

Tunicata.

KESTEVEN, H. LEIGHTON— <i>Australian Tunicates</i>	25
HERDMAN, W. A.— <i>Antarctic Tunicata</i>	302
RITTER, W. E.— <i>Study of a Tunicate</i>	450
JOHNSON, MYRTLE ELIZABETH— <i>Development of Salpa Chain</i>	564

I N V E R T E B R A T A .

Mollusca.

BAKER, F. C.— <i>Æcological Study of Molluscs</i>	451
---	-----

α. Cephalopoda.

TILL, ALFRED— <i>Beaks of Fossil Cephalopods</i>	25
NAEF, ADOLF— <i>Development of Cælotomic and Vascular Systems in <i>Loligo</i></i>	161
HOYLE, W. E.— <i>Catalogue of Recent Cephalopods</i>	162
WATKINSON, GRACE B.— <i>So-called Olfactory Organ in Cephalopods</i>	302
JOUBIN, L.— <i>Young <i>Spirala</i></i>	451
MASSY, ANNE L.— <i>Dibranchiate Cephalopods of Coasts of Ireland</i>	451
ROUVILLE, ETIENNE DE— <i>Salivary Juice of Cephalopods</i>	451
SAINT-HILAIRE, C.— <i>Follicular Epithelium of Cephalopods</i>	565

7. Gastropoda.

	PAGE
HEYDER, PAUL— <i>Development of Pulmonary Cavity in Slug</i>	25
LAMS, HONORÉ— <i>Polar Bodies in Arion empiricorum</i>	26
PIERON, H.— <i>Topographical Memory in Limpet and in Calyptræa</i>	26
VAYSSIÈRE, A.— <i>New Family of Æolidiæ</i>	26
MARCEAU, F.— <i>Adductor Muscles</i>	26
THIELE, JOH.— <i>Revision of Chitons</i>	162
NOWIKOFF, M.— <i>Eyes of Placophora</i>	162
RUSSELL, E. S.— <i>Growth of Limpet's Shell</i>	163
ORTON, J. H.— <i>Hermaphroditism in Crepidula fornicata</i>	163
IHERING, H. VON— <i>Classification and Distribution of Helicidæ</i>	163
DALL, W. H., & P. BARTSCH— <i>Monograph of West American Pyramidellidæ</i>	164
POLUSZYNSKI, GUSTAV— <i>Abnormalities in Genital Ducts of Helix pomatia</i>	303
KLEINERT, MAX— <i>Spermatogenesis in Helix</i>	303
VLÈS, FRED— <i>Noises made by Snail on Window-pane</i>	303
MORSE, EDWARD S.— <i>Early Stage of Acmæa</i>	451
TROJAN, E.— <i>Luminosity of Phyllirhoe bucephala</i>	565
BISHOP, HILDA M.— <i>Gastropod Foot and Branchial Cavity</i>	566
VAYSSIÈRE, A.— <i>New Genus of Nudibranchs</i>	566
<i>Tentacular Anomaly in Chromodoris elegans</i>	566
I'ERRIER, RÉMY, & H. FISCHER— <i>Adaptive Structure of Acera</i>	713
<i>Gill of Bulleidæ</i>	713
MACCURDY, H. M.— <i>Double Snail</i>	713

8. Lamellibranchiata.

GERMAIN, L.— <i>Malacology of Equatorial Africa</i>	26
HARMS, W.— <i>Postembryonic Development of Unionidæ</i>	164
PELSENER, PAUL— <i>Commensal Lamellibranchs</i>	303
COOPER, J. E., & H. B. PRESTON— <i>New Bivalves from Falkland Islands</i>	304
TOBLER— <i>Mussels Settling in Gas-vesicle of Seaveel</i>	304
SEYDEL, E.— <i>Byssus-apparatus of Lamellibranchs</i>	304
HOWORTH, HENRY H.— <i>History of Mya arenaria</i>	566
LYNCH, H.— <i>Marine Lamellibranchs of Siam</i>	566

Arthropoda.

STAMM, R. H.— <i>Muscle-insertions in Arthropods</i>	164
CALMAN, W. T.— <i>Guide to Crustacea, Arachnida, Onychophora, and Myriopoda of the British Museum</i>	452

a. Insecta.

CESTLUND, O. W.— <i>Outlines of Entomology</i>	27
BOURGOIS, J.— <i>Cases of Defensive Mimicry</i>	27
SILVESTRI, F.— <i>Studies on Hymenopterous Parasites</i>	27
SCHIMMER, F.— <i>Biology of Myrmecophila</i>	28
KRECKER, F. H.— <i>Eyes of Dactylopius</i>	29
MARTELLI, G.— <i>Study of Puss Moth</i>	30
VANEY, C., & A. CONTE— <i>Vitellus in Silkmoth's Eggs</i>	30
DEGENER, P.— <i>Intestinal Secretion in Dilephila</i>	30
<i>Abdominal Sensory Organ in Noctuidæ</i>	30
HIRSCHLER, JAN— <i>Development of Mid-gut in a Beetle</i>	30
CROSBY, C. R.— <i>Seed-infesting Chalcid Flies</i>	31
TARNANI, J. C.— <i>Luminescence in Chironomus</i>	31
FROMME, W.— <i>Pulex cheopis in Hamburg Docks</i>	31
BRUNTZ, L.— <i>Nephrocytes and Pericardial Cells of Orthoptera</i>	31
MORSE, MAX— <i>Nuclear Components in Sex-cells of Four Species of Cockroaches</i>	31
GÉRARD, POL— <i>Spermatogenesis in Stenobothrus biguttulus</i>	32
TRÄGÅRDH, IVAR— <i>New Phorid</i>	32
SCHEPOTIEFF, A.— <i>New Primitive Insect</i>	32
THEOBALD, F. W.— <i>Pests of the Hop</i>	33

	PAGE
BERLESE, A.— <i>Monograph on Myrientomata</i>	33
DEMOLL, R.— <i>Mouth-parts of Wasps and other Hymenoptera</i>	164
JONESCU, C. N.— <i>Brain of Hive-bee</i>	164
BRUES, C. T.— <i>Parasitic Hymenoptera from the Tertiary of Florissant</i>	165
WESCHE, W.— <i>Viviparity in Phoroceera serriventris and other Flies</i>	165
FULMEK, L.— <i>Gossyparia ulmi on Mistletoe</i>	165
WRIGHT, J. P.— <i>Tobacco Beetles</i>	165
SACK, P.— <i>Palaearctic Spongostylinae</i>	165
FREILING, H. H.— <i>Odoriferous Organs in Female Lepidoptera</i>	165
DEBAISIEUX, P.— <i>Oogenesis in Dytiscus marginalis</i>	166
WEITLAUER, FR.— <i>Luminosity of Glow-worm</i>	166
BALFOUR-BROWNE, F.— <i>Life-history of Agrionid Dragon-fly</i>	166
KING, J. J. F. X., & J. N. HALBERT— <i>Irish Neuroptera</i>	166
NUSBAUM, J., & B. FULINSKI— <i>Development of Endoderm in Mole-cricket</i>	166
TULLGREN, ALBERT— <i>Studies on Aphides</i>	167
BAGNALL, R. S.— <i>New Genera of Thysanoptera</i>	167
INJURIOUS <i>Insects</i>	167
SHIPLEY, A. E.— <i>Ectoparasites and Endoparasites of Grouse</i>	167
NEGER, F. W.— <i>Seed-gathering Ants</i>	304
BUGNION, E.— <i>Habits of Cœophylla smaragdina</i>	304
FOREL, A.— <i>Ants' Nests</i>	305
JANDA, VIKTOR— <i>Regeneration in Insects</i>	305
BORDAS, L.— <i>Thoracic Glands in Caterpillars</i>	305
VANEY, C., & A. CONTE— <i>Development of Eggs of Silk-moth</i>	305
LINDEN, MARIE VON— <i>Assimilation of Carbon Dioxide by Pupæ</i>	306
BORDAS, L.— <i>Malpighian Tubes in Larval Lepidoptera</i>	306
PÉREZ, CH.— <i>Histology of Metamorphosis</i>	306
" " <i>Metamorphosis of Malpighian Tubes in Muscids</i>	306
ANNANDALE, NELSON— <i>Living Species of Diplonema</i>	306
BEZZI, M.— <i>Empididæ</i>	306
GEORGEVITCH, JIVOÏN— <i>Alimentary Tract and Habits of Simulium columbaccensis</i>	306
GAUTHIER, J. CONST., & A. RAYBAUD— <i>Rat Fleas at Marseilles</i>	307
" " <i>Rat Flea capable of Biting Man</i>	307
PERRIN, ABELLE DE— <i>New Species of Rhipidius</i>	307
JORDAN, HERMANN— <i>External Digestion in Carabus auratus</i>	307
KIRCHHOFFER, OTTO— <i>Eyes of Pentamerous Beetles</i>	307
MORSE, MAX— <i>Reactions of Mealworms</i>	307
FULINSKI, BENEDIKT— <i>Development of Agelastia alni</i>	308
HEGNER, R. W.— <i>Effect of Centrifugal Force upon Eggs of Chrysomelid Beetles</i>	308
MCDUNNOUGH, JAMES— <i>Minute Structure of Gut in Chrysopa perla</i>	309
STITZ, H.— <i>Genital Apparatus of Neuroptera</i>	309
PIEROE, W. DWIGHT— <i>Revision of Order Strepsiptera</i>	309
HOFENER, K.— <i>New Strepsipteron</i>	310
BOLTON, H.— <i>New Species of Fossil Cockroach</i>	310
ESCHERICH, K.— <i>Ants and Plants</i>	452
JEANNEL, R.— <i>Cave Beetles</i>	452
POPOVICI-BAZOSANU, A.— <i>Larvæ of Megatoma undatu</i>	452
JOHNSON, CHARLES W.— <i>New Tipulidæ</i>	452
HERWERDEN, M. A. VAN— <i>Structure of Nucleus in Cells of Salivary Glands of Chironomus Larvæ</i>	452
BERTARELLI, E.— <i>Flies and Typhus Fever</i>	453
BECKER, R.— <i>Head and Mouth-parts of Dipterous Larvæ</i>	453
PANTEL, J.— <i>Adaptations of Parasitic Diptera</i>	453
KERSHAW, J. C. W.— <i>Structure, Habits, and Life-history of Candle Fly</i>	453
BECKER, E.— <i>Post-antennary Organ of Collembola</i>	453
HEWITT, C. G.— <i>Bionomics of the House-fly</i>	567
BACKHOFF, P.— <i>Development of the Dragon-fly</i>	568
ZANDER, E.— <i>Study of the Honey-bee</i>	568
DONCASTER, L.— <i>Gametogenesis of Gall-fly</i>	569
MASSONNAT, E.— <i>New Host of Lynchia mauri</i>	570
VANEY, C., & A. CONTE— <i>Caterpillars of Epichmopteryx helicinnella</i>	570
JACOBSON, E., & J. C. H. MELJERE— <i>Mosquito fed by Ant</i>	570

	PAGE
ALESSANDRINI, G.— <i>Piophilæ Larvæ in Cheese</i>	571
KRÜGER, E.— <i>Structure and Habits of Claviger testaceus</i>	571
GAUTHIER, J. CONST., & A. KAYBAUD— <i>Rat-fleas</i>	571
LEON, N.— <i>Roumanian Blood-sucking Diptera</i>	571
BUGNION, E.— <i>Structure of Trigonotys hahni</i>	571
DRENKELFORT, H.— <i>Study of an Ephemeroïd</i>	571
HAMMERSCHMIDT, JOHANN— <i>Development of Plasmatiidæ</i>	571
BORDAS, L.— <i>Glands of Caterpillars</i>	572
COLLINGE, WALTER E.— <i>Thysanura and Collembola of Midland Plateau</i>	572
SNODGRASS, R. E.— <i>Thorax of Insects and Articulation of Wings</i>	572
PARKER, J. B.— <i>Nesting Habits of Bembex nubilipennis</i>	713
KIEFFER, J. J., & P. JØRGENSEN— <i>Argentine Galls</i>	714
JANET, CHARLES— <i>Sensory Structures on Worker Bee's Mandible</i>	714
VIEHMAYER, H.— <i>Myrmecophilous Caterpillars</i>	714
KENNEL, J.— <i>Palæarctic Tortricidæ</i>	714
BUSCK, AUGUST— <i>Horn-feeding Lepidopterous Larvæ</i>	714
EDWARDS, T. G.— <i>Procession and Pupation of Larvæ of Onethocampa pinivora</i>	715
HEGNER, R. W.— <i>Effect of Centrifugal Force on the Development of Beetles</i>	715
BLAIN, A. W.— <i>Mytasis Narium</i>	716
AUSTEN, E. E.— <i>New Cordylobia</i>	716
WESCHÉ, W.— <i>Larvæ and Pupæ of West African Culicidæ</i>	716
MALLOCH, J. R.— <i>Subdivisions of Genus Phora</i>	716
BERTARELLI, E.— <i>Flies as Disseminators of Typhus</i>	716
DUDGEON, G. C.— <i>Hemiptera Injurious to Cocoa</i>	716
FELT, E. P.— <i>Injurious Insects</i>	717

β. Myriopoda.

IMMS, A. D.— <i>New Scutigera</i>	33
SINCLAIR, F. G.— <i>Abnormal Pair of Limbs in Lillobius</i>	167
BRÖLEMANN, H. W.— <i>Classification of Geophilomorpha</i>	168
SILVESTRI, F.— <i>Studies on Diplopoda</i>	168
„ „ <i>New Millipedes</i>	310
EFFENBERGER, W.— <i>Structure of Polydesmus</i>	310
EVANS, T. J.— <i>British Millipedes</i>	717

γ. Arachnida.

REUTER, ENZIO— <i>Structure and Development of Mites</i>	33
AMMANN, J.— <i>Swiss Tardigrada</i>	33
KAUTZSCH, G.— <i>Development of Agelena labyrinthica</i>	168
SAMSON, KATHARINA— <i>Structure and Habits of Ixodes ricinus</i>	168
KULCZYNSKI, VL.— <i>Fragmenta Arachnologica</i>	310
STRAND, EMBRIK— <i>New Cteniform Spiders from South America</i>	310
PURCELL, W. F.— <i>Development and Origin of Respiratory Organs in Araneæ</i>	310
„ „ <i>Phylogeny of Tracheæ in Araneæ</i>	311
JANECK, REINOLD— <i>Development of Lung-books and Tracheæ in Spiders</i>	312
MONTGOMERY, THOMAS H., JUN.— <i>Spinnerets, Cribellum, and Respiratory Organs of Spiders</i>	312
NORDENSKIÖLD, ERIK— <i>Structure of Ixodes redivivus</i>	312
KOLLMANN, MAX— <i>Functions of Lymphatic Gland of Scorpion</i>	454
BANKS, NATHAN— <i>Catalogue of Nearctic Spiders</i>	454
MONTGOMERY, THOS. H., JUN.— <i>Behaviour of Spiders</i>	454
GALIANO, E. FERNANDEZ— <i>Spiders of Spain</i>	454
COTTE, J.— <i>New Gall-mite on Hawthorn</i>	454
TIÉCHE— <i>Mites in Man</i>	455
DAHL, FR.— <i>Mites in Tumours</i>	455
MONTGOMERY, T. H.— <i>Courtship of Spiders</i>	573
SCHECHEL, EDWARD— <i>New Hydrachnids</i>	573
HIRST, S.— <i>New Genus of Solifugæ</i>	717
BOUVIER, E. L.— <i>Ten-legged Pantopod</i>	717
WALCOTT, CHARLES D.— <i>Olenellus and other Mesonacida</i>	718

c. Crustacea.		PAGE
BERNECKER, A.— <i>Minute Structure of Respiratory Organs in Crustaceans</i>		33
BOUVIER, E. L.— <i>Phylogeny of Atyidæ</i>		33
WOLTERECK, A.— <i>New Amphipods from Eastern Tropical Pacific</i>		34
SAYCE, A. O.— <i>Terrestrial Species of Talitrus from Victoria</i>		34
CHAPMAN, FREDERICK— <i>New Species of Leperditia</i>		34
CHATTON, E.— <i>Double Nauplius</i>		34
KOLLMANN, MAX— <i>Notes on Rhizocephala</i>		34
KEILHACK, L.— <i>Generation-cycles in Cladocera</i>		34
LANGHANS, V. H.— <i>Rudimentary Antennary Gland in Cladocera</i>		34
WALKER, A. O.— <i>Hippolyte gracilis in the British Area</i>		168
SOUTHWELL, T.— <i>Anomura of Kattianar</i>		168
HORNELL, J., & T. SOUTHWELL— <i>New Species of Pinnoceres</i>		168
GELDERER, CHARLES— <i>Digestive System of Schizopods</i>		169
CHATTON, E., & E. BRÉMENT— <i>New Copepod from an Ascidian</i>		169
PEARSE, A. S.— <i>Sex-recognition in Crayfishes</i>		312
RITCHIE, JAMES— <i>Distribution of Palinurus vulgaris in British Waters</i>		313
KNEBEL, WALTHER VON— <i>Jurassic and Modern Eryonidæ</i>		313
BROZEK, ARTUR— <i>Variability of Palæmonetes varians</i>		313
CALMAN, W. T.— <i>Blind Prawn from Galilee</i>		313
STRAUSS, E.— <i>Eyes of Gammarids</i>		313
TAIT, JOHN— <i>Agglutination of Blood Corpuscles in Gammarus</i>		313
VERHOEFF, K. W.— <i>Studies on Isopods</i>		314
CHATTON, E., & E. BRÉMENT— <i>Crustaceans living in Ascidians</i>		314
SCOTT, THOMAS— <i>Crustacea in Gizzard of Deep-sea Cuttlefish</i>		314
CALMAN, W. T.— <i>Wool-boring Crustacea from Christmas Island</i>		314
NERESHEIMER, E.— <i>Fresh-water Lernæopodidæ</i>		314
WYSS, OSCAR— <i>Autumnal Iridescence of Lakes</i>		314
WITHERS, THOMAS H.— <i>New Fossil Barnacles</i>		315
ANDREWS, C. W.— <i>Habits of Robber Crabs</i>		455
BUGNION, E.— <i>Genotiba and Acquired Characters</i>		455
DRZEWINA, ANNA— <i>Habits of Hermit Crabs</i>		456
RITCHIE, JAMES— <i>Paramola curviri in Scottish Waters</i>		456
KEMP, STANLEY— <i>Decapoda from North Side of Bay of Biscay</i>		456
MORGAN, W. DE— <i>Upogebia stелuta and Gebia deltura</i>		456
FUKUDA, T.— <i>Japanese Stomatopods</i>		456
RACOVITZA, E. G.— <i>Revision of Monolistrini</i>		456
TOLLINGER, J.— <i>Alimentary Tract of Lynceus</i>		456
HODGSON, T. V.— <i>Antarctic Isopods</i>		457
KOLLMAN, M.— <i>Twin Sacculina</i>		457
CHATTON, E., & E. BRÉMENT— <i>New Ascidicolous Copepods</i>		457
STANISLAW, JERZY— <i>Sympathetic Nervous System of Crustacea</i>		573
SEXTON, E. W.— <i>Amphipods from North Side of Bay of Biscay</i>		574
TAIT, JOHN— <i>Couagulation of Blood in Arthropoda</i>		574
HANSEN, H. J.— <i>Antarctic Schizopods and Cumacea</i>		574
ALCOCK, A.— <i>Indian Fresh-water Crabs</i>		575
BERGOLD, ALFRED— <i>Structure of Fresh-water Ostracods</i>		576
KOLLMANN, MAX— <i>Lernæodiscus</i>		576
KEMP, STANLEY— <i>Decapod Nutantia of Coasts of Ireland</i>		576
COUTIÈRE, HENRI— <i>Snapping Shrimps</i>		577
“ “ <i>Dimorphism of Males in Saron</i>		718
STEBBING, T. R. R.— <i>Australian Amphipods</i>		718
MAN, J. G. DE— <i>New Alpheidæ</i>		718
RATHBUN, MARY J.— <i>Rare Decapods</i>		718
BRUNELLI, G.— <i>Commensalism of Sea-anemones and Hermit-crabs</i>		718
SOUTHWELL, T.— <i>Notes on Ceylonese Hermit-crabs</i>		719
TAIT, JOHN— <i>Colour Change in Ligia</i>		719
“ “ <i>Blood-coagulation in Gammarus</i>		719
GAMBLE, F. W.— <i>Light and Pigment-formation in Crenilabrus and Hippolyte</i>		719
DADAY, E. VON— <i>East African Endomostraca</i>		720
JOLEAUD, A.— <i>Alleged Mimicry in Acorn-shells</i>		720
QUIDOR, A.— <i>Protandrous Hermaphroditism in Lernæopodidæ</i>		720
WILLEY, A.— <i>Association of Barnacles with Snakes and Worms</i>		721

Annulata.

	PAGE
DEMOLL, R.— <i>Eye of Aleiopa contrainii</i>	35
KOSTANECKI, K.— <i>Artificial Parthenogenesis in Arieia</i>	35
GRAVIER, CIL.— <i>Peruvian Polychæts</i>	35
FANTHAM, H. B., & ANNIE PORTER— <i>Disease in Arenicola</i>	35
BUCHANAN, GWYNNETH— <i>Blood-vessels of Australian Earthworms</i>	35
ARTS LOUIS DES— <i>Musculature of Hirudinea</i>	35
HALLEZ, PAUL— <i>Sagitta enflata</i>	36
KOLLMANN, MAX— <i>Albuminoid Reserves in Annelids</i>	169
ZÜRCHER, LEO— <i>Musculature of Owenia</i>	169
SOUTHERN, R.— <i>Pelagic Phyllodoceidæ of Irish Coasts</i>	169
ELPATIEWSKY, W.— <i>Primitive Germ-cells in Sagitta</i>	170
HARDING, W. A.— <i>New Leeches from Ceylon</i>	170
ZIELINSKA, JANINA— <i>Regeneration in Lumbricidæ</i>	315
MARTHS, L. COGNETTI DE— <i>Earthworms of Ruwenzori</i>	315
MOORE, J. PERCY— <i>American Polychæts</i>	315
BATHIER, F. A., & B. S. LYMAN— <i>Fossil Annelid Burrows</i>	315
PAUL, GEORG— <i>Phascolosoma minutum</i>	316
BEAUCHAMP, PAUL DE— <i>Parthenogenesis in Dinophilus conklini</i>	316
GOODRICH, E. S.— <i>Nephridia of Dinophilus and of Larvæ of Polygordius, Echiurus, and Phoronis</i>	316
BUCHNER, PAUL— <i>Oogenesis of Sagitta</i>	316
GODDARD, E. J.— <i>Australian Hirudinea</i>	316
ASHWORTH, J. H.— <i>Giant Nerve-cells and Fibres of Halla</i>	457
SOUTHERN, R.— <i>Polychæts from the Atlantic adjacent to Ireland</i>	457
GODDARD, E. J.— <i>Australian Hirudinea</i>	458
OKA, ASAJIRO— <i>Japanese Leeches</i>	458
KRECKER, F. H.— <i>Regeneration in Oligochæts</i>	577
ASHWORTH, J. H.— <i>Species of Arenicola in Paris Museum</i>	579
HACHLOV, L.— <i>Body-wall of Leeches</i>	579
STEWART, F. H.— <i>New Gephyrean Type</i>	579
CARY, L. R.— <i>Life-history of Diplodiscus temporatus</i>	579
JOHNSTONE, JAS.— <i>Parasites from Fishes from Irish Sea</i>	581
WARD, HENRY B.— <i>Pisciulopsis</i>	581
DAMPF, ALFONS— <i>Cysticeroid from a Jerboa-flea</i>	581
WALLIN, IVAN E.— <i>Genus Alloerædium</i>	581
ANDRÉ, J.— <i>Nervous System of Polystomum integerrimum</i>	582
<i>Eyes of Polystomum integerrimum</i>	582
LARNE, G. R.— <i>New Species of Proteocephalus</i>	582
LEON, N.— <i>Diplogonoporus brauni</i>	582
WAHL, BRUNO— <i>Parasitic Turbellarians</i>	582
GRAFF, LUDWIG VON— <i>North American Turbellarians</i>	582
YATSU, N.— <i>Experiments on Cleavage of Cerebratulus Ovm</i>	582
SOUTHERN, R.— <i>Marine Annelids of Dublin Bay</i>	721
VIGUIER, C.— <i>Precocious Maturity of Larval Spiomid</i>	721
HARGITT, C. W.— <i>Spawning of Hydroides dianthus</i>	721

Nematohelminthes.

LINSTOW, O. VON— <i>Studies on Nematodes</i>	36
<i>New Nematodes</i>	36
VALLILLO, G.— <i>Ascaris mystax in Lion</i>	36
SOUTHERN, ROWLAND— <i>Structure and Life-history of Rhabditis brassicæ</i>	36
BUSSE, OTTO— <i>Trichinosis in Posen</i>	36
MATHIS, C., & M. LÉGER— <i>Microfilaria of Fowl</i>	36
D'HERELLE, F., & H. SEIDELIN— <i>Two Filaria in Snake's Blood</i>	37
RQUIER, J. K.— <i>Larva of Echinorhynchus in Tench</i>	37
GOLDSCHMIDT, R.— <i>Nervous System of Ascaris</i>	170
BILEK, FR.— <i>Fibrillar Structures in Muscle-cells and Intestinal Cells of Ascaris</i>	170
MARTINI, E.— <i>Subcuticula and Lateral Areas of Nematodes</i>	170
SHIPLEY, A. E.— <i>Nematodes of Red Grouse</i>	171
RAILLIET, A., & A. HENRY— <i>Nematodes of the Eye</i>	317

	PAGE
BALDASSERONI, VINCENZO— <i>Filarie in Ixodes</i>	317
RAILLIET, A., & A. HENRY— <i>Genus Onchocerca</i>	317
SVABENIK, JAN— <i>Structure of Gordius</i>	317
HORN, PAUL— <i>Species of Tylenchus in Moss</i>	458
RAILLIET, A., & A. HENRY— <i>Nematodes of the Eye</i>	458
LINSTOW, O. VON— <i>New Species of Atractis</i>	458
JAMMES, L., & A. MARTIN— <i>Adaptation of Nematodes to Temperature of their Hosts</i>	458
LEIPER, R. T.— <i>New Nematode from Trinitadul</i>	583
LINSTOW, O. VON— <i>New Species of Pseudalinus</i>	722
OZOUX, M.— <i>Filaria in Turkey's Eye</i>	722
JAMMES & MARTIN— <i>Significance of Chitin in Nematode Development</i>	722
POTTS, F. A.— <i>Hermaphroditism among Free-living Nematodes</i>	722

Platyhelminthes.

LINSTOW, O. VON— <i>New Species of Davainea</i>	37
MRÁZEK, AL.— <i>Excretory System in Tricelids</i>	37
RODENWALDT, E.— <i>New Trematode from Man</i>	37
STEINMANN, P.— <i>New Planarians</i>	171
HALLEZ, P.— <i>Paravortex carlii</i>	171
DETON, WILLY— <i>Synopsis in Thysanozoon brochei</i>	171
SSNITZIN, D. H.— <i>Relationships of Digenic Trematodes</i>	171
LEON, N.— <i>Abnormalities in Bothriocephalus</i>	172
SPATLICH, W.— <i>Structure of Tetrabothrius</i>	172
PINTNER, TH.— <i>Posterior End of Rhynchobothrius Chain</i>	172
SHIPLEY, A. E.— <i>Tapeworms of Red Grouse</i>	172
" " <i>Parasites of Birds allied to Grouse</i>	172
WEISS, ANNIE— <i>Australian Tricelids</i>	318
HALLEZ, PAUL— <i>New Type of Turbellarian</i>	318
MICOLETZKY, H.— <i>Turbellarians of the Gulf of Trieste</i>	318
GONDER, RICHARD— <i>Peculiar Trematode of the Mole</i>	318
PRATT, HENRY S.— <i>Cuticula and Subcuticula of Trematodes and Cestodes</i>	318
RANSOM, B. H.— <i>Tapeworms of North American Birds</i>	319
JOINSTON, T. HARVEY— <i>Entozoa of Monotremes and Marsupials</i>	319
NUSBAUM, J., & M. OXNER— <i>Regeneration in Nemerteans</i>	319
PUNNETT, R. C., & C. FORSTER COOPER— <i>Nemerteans from Eastern Indian Ocean</i>	319
HALLEZ, PAUL— <i>Protective Encystation of Fresh-water Nemerteans</i>	319
" " <i>Summer and Winter Spawning in a Fresh-water Nemerteans</i>	320
YATSU, NASHIDE— <i>Ookinesis in Cerebratulus lacteus</i>	320
PUTZU, J.— <i>Detection of Echinococcus Disease</i>	459
MATARÉ, FRANZ— <i>New Tetracotyle from Brain of Minnow</i>	459
SSNITZIN, D. TH.— <i>Bucephalus</i>	459
BLAIZOT, L.— <i>New Trematode from Frog</i>	459
MRÁZEK, AL.— <i>Distomid Cyst in Blood-vessels of an Oligochaet</i>	459
KATSURADA, F., & T. HASHEGAWA— <i>Life-history of Schistosomum japonicum</i>	459
LÖHNER, LEOPOLD— <i>Structure of Polycheirus caudatus</i>	459
HALLEZ, PAUL— <i>Fresh-water Nemerteans</i>	460
JOUBIN, L.— <i>Antarctic Nemerteans</i>	460
SOUTHWELL, T.— <i>Adult of Pearl-inducing Worm</i>	723
" " <i>Endogenous Multiplication in Larvæ of Tetrarhynchus unionifactor</i>	723
OXNER, M.— <i>Regeneration in Nemerteans</i>	723
YATSU, N.— <i>Egg of Cerebratulus</i>	724
WIJNHOF, G.— <i>Structure of Cephalothrix</i>	725
PLESSIS, G. DU— <i>Hermaphroditism of Proserochmus cluparedi</i>	725

Incertæ Sedis.

NORMAN, A. M.— <i>Polyzoa of Madeira</i>	37
DAWYDOFF, C.— <i>Regeneration in Enteropneusts</i>	173
RICHTERS, FERD.— <i>Studies in Tardigrada</i>	173
GODDARD, E. J.— <i>Australian Fresh-water Polyzoa</i>	320
SCHEPOTIEFF, A.— <i>Indian Ocean Pterobranchia</i>	320
BEAUCHAMP, P. DE— <i>Hæmocœle in Dinophilus</i>	460

	PAGE
GODDARD, E. J.— <i>Polyzoan on Pontobdella</i>	460
GREGORY, J. W.— <i>Cretaceous Bryozoa</i>	460
DOGIEL, V.— <i>New Catenata</i>	460
CAULLERY, M., & A. LAVALLÉ— <i>Infection of Ophiuroid with Rhopalura</i>	726

Rotifera.

ROUSSELET, C. F.— <i>Distribution of Rotifera</i>	173
DADAY, E. VON— <i>Rotifera of Turkestan</i>	173
MURRAY, JAMES— <i>Antarctic Rotifera</i>	461
SHULL, A. F.— <i>Life-cycle of Hydatina senta</i>	583

Echinoderma.

AGASSIZ, ALEXANDER— <i>Teeth and a Lantern in Echinoues</i>	37
SOKOLOV, IWAN— <i>Luminosity of Ophiuroids</i>	38
BECHER, S.— <i>Systematic Position of Rhabdionolpus Nova-Zelandiæ</i>	38
VERRILL, A. E.— <i>Notes on North American Starfishes</i>	174
MORGULIS, S.— <i>Regeneration in Ophiocoma pumila</i>	174
MCCLENDON, J. F.— <i>Ophiurans of San Diego</i>	174
HORN YOLD, H. A. G.— <i>Mode of Feeding in Echinocardium and Spatangus</i>	174
EDWARDS, C. I.— <i>Development of Holothuria floridana</i>	174
CLARK, H. L.— <i>Echinoderms of Thetis' Collection</i>	174
FISHER, W. K.— <i>New Starfishes</i>	321
BROWN, R. N. RUDMOSE— <i>Echinoids and Asteroids from Mergui and Burma</i>	321
" " " <i>Echinoids from Portuguese East Africa</i>	321
SIMPSON, J. J., & R. N. RUDMOSE BROWN— <i>Asteroids from Portuguese East Africa</i>	321
MANGOLD, E.— <i>Reactions of Echinoderms</i>	321
CLARK, AUSTIN HOBART— <i>Affinities of Echinoidea</i>	322
BELL, F. JEFFREY— <i>Indian Ocean Echinoderms</i>	461
HORN YOLD, A. GANDOLFI— <i>Gemmiiform Pedicellariæ</i>	461
BENHAM, W. B.— <i>New Zealand Echinoderms</i>	461
RITCHIE, JAMES— <i>Holokuria forskali in Scottish Waters</i>	462
GARBOWSKI, TAD.— <i>Experiment with Sea-urchin Ova</i>	584
KOEHLER, RENÉ— <i>Indian Ocean Shallow-water Asteroids</i>	584
LUDWIG, H.— <i>New Order of Asteroids</i>	726

Cœlentera.

BOHN, GEORGES— <i>Movements and Sensory Reactions of Vertilhon cynomorium</i>	38
WIETRZYKOWSKI, W.— <i>Development of Lucernarids</i>	38
CERFONTAINE, PAUL— <i>Study of Cerianthus oligopodus</i>	39
WARREN, ERNEST— <i>Hydroïd parasitic on Hydroïd</i>	39
THOMSON, J. A.— <i>Note on Deudrobrachia fullax Brook, a Rare and Remarkable Antipatharian</i>	142
HADŽI, JOVAN— <i>Nervous System of Hydra</i>	175
DOWNING, ELLIOT R.— <i>Oogenesis of Hydra</i>	175
KUHN, ALFRED— <i>Budding and Shoot-formation of Hydroïds</i>	175
TOPPE, O.— <i>Cnidoblasts of Hydra</i>	176
EVANS, WM., & J. H. ASHWORTH— <i>Medusoids, Medusæ, and Ctenophores of Firth of Forth</i>	176
GROSELJ, PAUL— <i>Nervous System of Anemones</i>	176
WILSMORE, LEONORA J.— <i>Zoontheæ from Queensland and New Hebrides</i>	177
LANG, W. D.— <i>Growth-stages in Parasmilia</i>	177
KÜKENTHAL, W.— <i>Observations on Living Alcyonarians</i>	177
STEPHENS, JANE— <i>Alcyonarians of Irish Coasts</i>	177
HICKSON, S. J.— <i>New Species of Stachyodes</i>	177
THOMSON, J. ARTHUR, & J. J. SIMPSON— <i>Indian Ocean Alcyonarians</i>	178
SUMMERS, S. L. M.— <i>Antipatharians from the Indian Ocean (Plate V.)</i>	273
PAX, F.— <i>Studies on Actinians</i>	322
TORREY, H. B., & F. L. KLEEBERGER— <i>New Species of Cerianthus</i>	322
BOHN, GEORGES— <i>Rhythm in Sea-anemones</i>	322

HERON-ALLEN, E., & A. FARLAND— <i>On the Recent and Fossil Foraminifera of the Shore-sands of Selsey Bill, Sussex.—VI. A Contribution towards the Etiology of Massilina secans (d'Orbigny sp.)</i>	693
HATTON, E.— <i>Nucleus of Amœbæ</i>	728
“ <i>Parasites of Labridæ</i>	728
MESNIL, F., & E. BRIMONT— <i>Trypanosome in an Edentate</i>	729
LAVERAN, A., & A. PETTIT— <i>Trypanosome of Lerot</i>	729
MARTIN, C. H.— <i>Division of Trypanoplasma congeri</i>	729
MATHIS, C., & M. LÉGER— <i>New Parasites in Bulbul's Blood</i>	729
KUNSTLER, J., & CH. GINESTE— <i>Cytoplasmic Fibrillation of Chilomonas</i>	729
KOFOID, C. A.— <i>Revision of Genus Ceratocorys</i>	729
LAVERAN, A., & A. PETTIT— <i>Endogenous Multiplication of Hæmogregarina sebai</i> ..	730
FRANÇA, C.— <i>Piroplasmidæ</i>	730
NÉGRE, L.— <i>Intestinal Stage of Sarcosporidium</i>	730
FIEBIGER, J.— <i>Miescher's Bodies</i>	730

BOTANY.

GENERAL,

Including the Anatomy and Physiology of Seed Plants.

Cytology,

including Cell-Contents.

GATES, R. R.— <i>Chromosomes in Enothera</i>	43
GRIGGS, R. F.— <i>Mitosis in Synchronous</i>	43
WESTER, D. H.— <i>Study of Chitin</i>	44
MAIGE, A.— <i>Chromosomes of Asphodelus microcarpus</i>	182
LIDFORSS, B.— <i>Connecting Threads between Nucleus and Chromatophores</i>	329
SENN, G.— <i>Form and Change of Position of Chromatophores</i>	329
YAMANOUCHI, S.— <i>Chromosomes in Osmunda</i>	330
RENNER, O.— <i>Lithocysts in Picea</i>	466

Structure and Development.

Vegetative.

BAILEY, I. W.— <i>Wood Structure in Pinæ</i>	44
CHEVALIER, A.— <i>Wild and Cultivated Dioscorea in Tropical Africa</i>	44
ALTEN, H. VON— <i>Studies on Roots</i>	45
KUSANO, S.— <i>Studies in Aeginetia</i>	45
BORESCH, K.— <i>Gum-flow in Relation to Anatomy in Bromeliaceæ</i>	182
PLANT, M.— <i>Physiological "Separating-Layers" in Gymnosperms, Equisetaceæ, and the Bryophytes</i>	330
WARMING, E.— <i>Saxifragaceæ</i>	330
GREGORY, R. P.— <i>Histology of Giant and Ordinary Primula sinensis</i>	331
LANGE, F.— <i>Classification of the Aloes by Leaf-structure</i>	331
ALTEN, H. V.— <i>Callus-formations in Nuphar</i>	466
GORIS, M. A.— <i>Anatomical Study of the Mangifereæ</i>	590
DANIEL, M. JEAN— <i>Branch Types and the Age of Trees</i>	591
THOMPSON, W. P.— <i>Phyletic Significance of Ray Tracheids in Coniferæ</i>	731

	PAGE
Reproductive.	
OTTLEY, A. M.— <i>Gametophytes and Fertilisation in Juniperus</i>	45
SAXTON, W. T.— <i>Ovule, Gametophytes, and Embryo of Widdringtonia</i>	46
MCALLISTER, F.— <i>Embryo-sac of Smilacina stellata</i>	46
BROWN, W. H.— <i>Embryo-sac of Habernaria</i>	47
COOK, M. T.— <i>Embryology of the Nympheaceæ</i>	47
HIMMELBAUR, W.— <i>Flower-morphology and Embryology of Datiscæ</i>	183
STEPHENS, E. L.— <i>Embryology of Penæceæ</i>	183
SAXTON, W. T.— <i>Embryology of Eucephalartos</i>	331
STEINBRINCK, C.— <i>Pollination-mechanism in Ricinus</i>	332
HEINRICHER, M. E.— <i>Germination of Seeds of Parasitic Plants</i>	332
WIESNER, J.— <i>Change in direct Sunlight during its Passage through Foliage</i>	333
NICOLAS, G.— <i>Respiration of Vegetative Organs of Vascular Plants</i>	333
NICHOLS, G. E.— <i>Morphology of Juniper</i>	467
YOUNG, MARY S.— <i>Morphology and Relationships of the Podocarpineæ</i>	731
Physiology.	
Nutrition and Growth.	
LUETZELBURG, P. VON— <i>Utricularia</i>	183
RENNER, O.— <i>Transpiration</i>	467
ROSHARDT, P. A.— <i>Function of Living Cells in Ascent of Sap</i>	468
LAVISON, J. DE RUFZ DE— <i>Function of the Endodermis and Selective Absorption by Protoplasm</i>	591
NICLOFF, TH.— <i>Youth-form of Leaves and its Significance</i>	592
DIXON, H. H., & W. R. G. ATKINS— <i>Osmotic Pressure in Plants</i>	592
SABLON, LECLERC DU— <i>Ascent of Sap in Trees</i>	593
Irritability.	
SILBERBERG, B.— <i>Stimulation of Storage Tissue by Zinc Sulphate</i>	47
LINSBAUER, K., & E. ABRANOWICZ— <i>Chloroplast-movements</i>	184
STREETER, S. G.— <i>Influence of Gravity on Growth of Amanita</i>	331
REED, H. S.— <i>Chemical Reagents in Relation to Wheat-seedling</i>	334
LUBIMENKO, M.— <i>Influence of Light upon Fruit- and Seed-development</i>	593
Chemical Changes.	
MAQUENNE, L., & DEMOUSSY— <i>Bluckening of Green Leaves</i>	335
General.	
COKER, W. C.— <i>Vitality of Pine Seeds</i>	47
WHITE, J.— <i>Ferments and Latent Life of Resting Seeds</i>	48
CAMPBELL, D. H.— <i>New Flora of Krakatau</i>	48
GANONG, W. F.— <i>Balls of Vegetable Matter from Sandy Shores</i>	49
SCHWEIGER, J.— <i>Systematic Relationship of Sarracenia and Cephalotus</i>	184
BEQUEREL, P.— <i>Variation of Zinnia due to Traumatism</i>	185
TRABUT, M.— <i>Origin of Cultivated Oats</i>	185
BROCKMANN-JEROSCH, H.— <i>New Fossil Discoveries and their Significance</i>	185
WIELAND, G. R.— <i>Williamsonias of Mizteca alta</i>	335
STRASBURGER, E.— <i>Character of Graft-hybrids</i>	335
MARRYAT, D. C. E.— <i>Hybridisation in Mirabilis</i>	336
WHELDALE, M.— <i>Inheritance of Flower-colour in Antirrhinum majus</i>	336
" " <i>Physiological Interpretation of Flower-colour</i>	337
SHULL, G. H.— <i>Inheritance of Sex in Lychnis</i>	337
" " <i>Inheritance of Colour in Lychnis</i>	337
TUMELLE, H., & H. PERRIER DE LA BATHIE— <i>Clusiaceæ of North-west Madagascar</i>	732

CRYPTOGAMS.

Pteridophyta.

PELOURDE, F.— <i>Structure of Fossil and Living Ferns</i>	49
COMPTON, R. H.— <i>Anatomy of Matonia sarmentosa</i>	49
EAMES, A. J.— <i>Centripetal Xylem in Equisetum</i>	50

	PAGE
BLACK, C. A.— <i>Imbedded Antheridia in Dryopteris and Nephrodium</i>	50
CAMPELLE, D. H.— <i>Prothallium and Embryo of Danaea</i>	50
ARNOLDI, W.— <i>Germination of Salcinia natans</i>	51
BENEDICT, R. C.— <i>Botrychium ternatum and its Allies</i>	51
HERTER, W.— <i>New Species of Lycopodium</i>	51
UNDERWOOD, L. M., & OTHERS— <i>North American Fern-flora</i>	51
POYSER, W. A., & OTHERS— <i>North American Ferns</i>	51
BOLDING, I.— <i>Ferns of the Dutch West Indies</i>	51
ROSENSTOCK, E.— <i>Spruce's South American Ferns</i>	52
WILDEMAN, E. DE.— <i>Ferns of the Congo</i>	52
PIROTTA, R.— <i>Ferns of Ruwenzori</i>	53
CHRIST, H.— <i>Ferns of the Far East</i>	53
<i>New Species of Malasian and Philippine Ferns</i>	53
CHRYSLER, M. A.— <i>Fertile Spike of the Ophioglossaceæ</i>	186
SINNOTT, E. W.— <i>Foliar Gaps in the Osmundaceæ</i>	186
YAMANOUCHI, S.— <i>Chromosomes in Osmunda</i>	187
GEORGEVITCH, P.— <i>Apospory and Apogamy in Trichomanes</i>	187
BOUBIER, M.— <i>Stigmata in the Hymenophyllaceæ</i>	187
MITCHELL, G.— <i>Strobilus of Selaginella</i>	187
BRUCHMANN, H.— <i>Selaginella Preissiana</i>	188
SHATTUCK, CH.— <i>Origin of Heterospory in Marsilia</i>	188
PERRIN, G.— <i>Fertilisation of Fern-prothallia</i>	189
FARMER, J. B., & L. DIGBY— <i>Cytology of Varietal and Hybrid Ferns</i>	189
FISCHER, H.— <i>Aspidium remotum</i> Al. Br.	190
LÉVEILLÉ, H.— <i>New French Ferns</i>	190
GULIA, G.— <i>Pteridophyta of Malta</i>	190
MAXON, W. R.— <i>Studies of Tropical American Ferns</i>	190
CHRISTENSEN, C.— <i>American Species of Dryopteris</i>	191
COPELAND, E. B.— <i>Ferns of the Philippines</i>	191
CHRIST, H.— <i>Ferns of Costa Rica</i>	191
<i>Ferns of New Guinea</i>	191
TAKEDA, H.— <i>Japanese Lycopodiades</i>	191
MAKINO, T.— <i>Japanese Ferns</i>	192
CAMBIER, R., & A. RENIER— <i>Structure and Position of Pinakodendron</i>	192
ZALESKY, M. D.— <i>New Fossil Dadoxylon</i>	192
PORTER— <i>Aloys Sodi</i>	192
TWISS, E. M.— <i>Prothallia of Anemia and Lygodium</i>	337
WUIST, E. D.— <i>Monœcious Prothallia in Onoclea</i>	338
BENEDICT, R. C.— <i>Peculiar Habitat for Campptosorus</i>	338
SCHAFFNER, J. H.— <i>Interesting Botrychium Habitat</i>	338
ULBRICH, E.— <i>New Variety of the Common Ophioglossum</i>	338
KÜMMERLE, J. B.— <i>New Species of Ceterach</i>	339
LOJACONO-POJERO, M.— <i>Italian Ferns</i>	339
NASH, G. V.— <i>Ferns of New York Botanical Garden</i>	339
CLUTE, W. N., & OTHERS— <i>North American Ferns</i>	339
SCHAFFNER, J. H.— <i>Pteridophytes of Ohio</i>	340
CHRIST, H.— <i>Ferns of Costa Rica</i>	340
<i>Ferns of Corea and China</i>	340
WERNHAM, H. F.— <i>Morphology of Phylloglossum</i>	468
STILES, W.— <i>Structure of Psilotum flaccidum</i>	469
BOWER, F. O.— <i>Phylogeny of the Filicales. I. Plagiogygia</i>	469
STEPHENS, E. L., & M. G. SYKES— <i>Apogamy in Pteris droosmuntiana</i>	470
HEILBRON, A.— <i>Apogamy, Hybridisation, and Heredity in certain Ferns</i>	470
HOYT, W. D.— <i>Fertilisation and Hybridisation in Ferns</i>	470
SLOSSON, M.— <i>Dryopteris Hybrids in North America</i>	471
LAMBERMAYR, L.— <i>Orientation of Botrychium Lunaria</i>	471
KIDSTON, R.— <i>Zygopteris Grayi</i>	471
CUPINO, L.— <i>East African Ferns</i>	471
CAMPBELL, D. H.— <i>Development of Angiopteris and Kaulfussia</i>	594
KRASSER, F.— <i>Fossil Marattiaceæ</i>	595
KIDSTONE, R., & D. T. GWYNNE-VAUGHAN— <i>Fossil Osmundaceæ</i>	595
FAULL, J. H.— <i>Stele of Osmunda cinnamomea</i>	595

	PAGE
GORDON, W. T.— <i>Fossil Osmundaceæ and Zygopteridæ</i>	596
LIGNIER, O., & F. PELOURDE— <i>Fossil Ferns of France</i>	596
LANG, W. H.— <i>Suspensor in Helminthostachlys</i>	596
VERNON, R. D., & I. J. WILLS— <i>Schizoneura paradoxa</i>	596
THOMAS, H. H.— <i>Assimilating-tissue of Fossil Ferns (Cidamites)</i>	596
BRUCHMANN, H.— <i>Prothallial Development in Lycopodium</i>	597
TRAIL, J. W. H.— <i>Lycopodium Selago: a curious habitat</i>	597
BORODINE, J.— <i>Stomata of Lycopodium annotinum</i>	598
HALLE, T. G., & K. YASUI— <i>Sagenopteris and Hydropterangium</i>	598
SYKES, M. G., & W. STILES— <i>Cones of Selaginella</i>	598
WORSDELL, W. C.— <i>Rhizophore of Selaginella</i>	599
HOLDEN, H. S.— <i>Periderm-formation in Filicineæ Petioles</i>	599
<i>Note on a Wounded Myelozylon</i>	599
PAGE, L.— <i>Peculiar Fern Prothallia</i>	599
WUIST, E. D.— <i>Culture of Fern Prothallia</i>	600
CHRIST, H.— <i>Geography of Ferns</i>	600
CHRISTENSEN, C.— <i>Olaf Swartz's Types of Ferns</i>	600
BENEDICT, R. C.— <i>Relationships of the Genera of the Vittariaceæ</i>	601
WATTAM, W. E. I.— <i>Hymenophyllum peltatum in Yorkshire</i>	601
SEYMAN, W.— <i>Asplenium Lingelsheimi, a New Hybrid</i>	601
CHRIST, H.— <i>Two Species of Platycerium</i>	601
MOORE, H. KINGSMILL— <i>Varieties of Polypodium vulgare</i>	601
SENNEN, FRÈRE— <i>New-European Fern</i>	602
HOPKINS, L. S.— <i>New North American Ferns</i>	602
DODGE, R., & OTHERS— <i>North American Ferns</i>	602
WEATHERBY, C. A.— <i>American Forms of Lycopodium complanatum</i>	603
ROSENSTOCK, E.— <i>New Tropical Ferns</i>	603
HICKEN, C. M.— <i>Ferns of Argentina</i>	603
JOHNSTON, J. R.— <i>Ferns of Venezuela</i>	603
CHRIST, H.— <i>Ferns of South China</i>	603
MEYER, A.— <i>Ancestry of Plants</i>	733
MOTTIER, D. M.— <i>Sex of Gametophyte of Onoclea</i>	733
STOKEY, A. G.— <i>Sporangium of Lycopodium pilayooides</i>	734
SENN, G.— <i>Tubers of Polypodium Brunei</i>	734
GEORGEVITCH, P.— <i>Apospory and Apogamy in Trichomanes</i>	734
BOYD, W. B.— <i>Lastrea remota</i>	734
MACDONALD, J. J.— <i>Scotch Ferns</i>	734
MARTEN, J.— <i>Indian Ferns</i>	735

Bryophyta.

LAMPA, E.— <i>Relationship of Liverworts to Ferns</i>	53
GRAHAM, M.— <i>Sporogonium and Gametophore of Conocephalum</i>	53
COKER, W. C.— <i>Liverwort Types for Elementary Classes</i>	54
WEINERT, H.— <i>Physiology of Liverwort-rhizoids</i>	51
ZIELINSKI, F.— <i>Biology of the Archegonium and Calyptra</i>	54
JANZEN, P.— <i>Life-history of Funaria hygrometrica</i>	55
DIXON, H. N.— <i>Accessory Leaves in Mnium and Orthomnium</i>	55
STEPHANI, F.— <i>Monograph of the Hepaticæ</i>	55
SHEPPARD, T., & W. WATSON— <i>Muscineæ of Yorkshire</i>	55
STIRTON, J.— <i>New Scottish Mosses</i>	56
HAGEN, I.— <i>Norwegian Moss-flora</i>	56
PETROW, J. P., & A. A. SAPHIN— <i>Russian Bryophytes</i>	56
COPEY, A.— <i>Hepaticæ of the Haute-Saone</i>	56
GREBE, C.— <i>New German Mosses</i>	56
JANZEN, P.— <i>Hepaticæ of Eisenach</i>	57
LORSKE, L.— <i>Moss flora of Zillertal</i>	57
GYÖRFFY, I.— <i>Mosses of Hungary</i>	57
PODPERA, J.— <i>Moss-flora of Moravia</i>	57
COPEY, A.— <i>Moss-flora of Greece</i>	57
LUISIER, A.— <i>Moss-flora of Portugal</i>	58
<i>Moss-flora of Madeira</i>	58
MICHELETTI, L.— <i>Mosses of Italian East Africa</i>	58

	PAGE
NEGRI, G., & G. GOLA— <i>Bryophyta of Ruwenzori</i>	58
GROUT, A. J., & E. J. HILL— <i>North American Species of Amblystegium</i>	58
COKER, W. C., & E. G. BRITTON— <i>North American Bryophytes</i>	59
EVANS, A. W.— <i>Hepaticæ of New England</i>	59
STEPHANI, F.— <i>Mexican Hepaticæ</i>	59
WILLIAMS, R. S.— <i>Bolivian Mosses</i>	59
BROTHERUS, V. F.— <i>New Philippine Mosses</i>	59
HERZOG, TH.— <i>Mosses of New Guinea and the Moluccas</i>	59
GEPP, A.— <i>Bryophyta of Fiji</i>	60
RENAULD, F.— <i>Some Forms of Drepanocladus</i>	60
ROTH, G.— <i>Drepanocladus furcatus</i>	60
WINTER— <i>Some Critical Species of Pohlia</i>	60
DOUIN, I.— <i>Bryum arvense</i>	60
GYÖRFFY, I.— <i>Some Bryological Rarities</i>	60
LETT, H. W.— <i>John Henry Davies (1838-1909)</i>	61
HUSNOT, T., & J. RÖLL.— <i>A. Geheeb: Neerology</i>	61
SMITH, A. M.— <i>Leo Lesqueureux</i>	61
WILSON, M.— <i>Spermatogenesis of Mnium</i>	192
ÅKERMAN, Å.— <i>Chemotaxis of Spermatozooids in Marchantia</i>	193
LORCH, W.— <i>Mechanism of Cohesion in Moss-leaves</i>	193
ANDREWS, A. LE ROY— <i>Nomenclature of Sphagnum</i>	193
CRAMPTON, C. B., & OTHERS— <i>British Bryophyta</i>	193
ROTH, G.— <i>New and Rare European Mosses</i>	194
SCHMIDT, J.— <i>Hepaticæ of Hamburg</i>	194
GEHEEB, A.— <i>Mosses of the Röhnggebirge</i>	194
GUINET, A.— <i>Mosses of Savoy</i>	194
MICHELETTI, L.— <i>Bryophyta of Sicily</i>	194
GREENWOOD, H. E., & OTHERS— <i>North American Bryophyta</i>	194
HERZOG, T.— <i>Bolivian Mosses</i>	195
JENSEN, C.— <i>Sphagnaceæ of Siberia</i>	195
CARDOT, J.— <i>Mosses of Japan and Corea</i>	195
BRITTON, E. G.—C. F. Austin: <i>North American Bryologist</i>	195
HAYNES, C. C.— <i>Charles Lacouture</i>	195
HIRSH, P. E.— <i>Development of Air-Chambers in Ricciaceæ</i>	340
MARCHAL, ÉL. & ÉM.— <i>Apospory and Sexuality in the Mosses</i>	340
RENAULD, F.— <i>Proper Value of a Species</i>	341
STEINBRINCK, C.— <i>Cohesion-mechanism of Moss-leaves</i>	341
THE MOSS EXCHANGE CLUB— <i>British Mosses</i>	341
WHELDON, J. A.— <i>Lancashire Mosses</i>	342
CHEETHAM, C. A.— <i>Yorkshire Mosses</i>	342
STABLER, GEORGE (1839-1910)	342
NICHOLSON, W. E.— <i>New Hybrid Moss in Sussex</i>	342
BRITTON, E. G.— <i>Mosses found in Conservatories</i>	342
SCHIFFNER, V.— <i>New European Frullania</i>	342
" " <i>New Species of Anastrophyllum</i>	343
LORCH, W.— <i>Polytrichaceæ</i>	343
HAGEN, I.— <i>Orthothecium strictum</i> or <i>O. rubellum</i>	343
CARDOT, J.— <i>Notes on Fontinalis</i>	343
RENAULD, F.— <i>Notes on Drepanocladus</i>	343
WINTER, H., & I. HAGEN— <i>Norwegian Mosses</i>	343
SCHMIDT, J.— <i>Mosses of Hamburg</i>	343
GLOWACKI, J.— <i>Muscineæ of the Julian Alps</i>	344
SOMMIER, S.— <i>Italian Muscineæ</i>	344
MEYLAN, C., & OTHERS— <i>French Mosses</i>	344
DISMIER, G.— <i>Mosses of the Pyrenees</i>	344
LUISIER, A.— <i>Muscineæ of Malcira</i>	344
BRITTON, E. G., & OTHERS— <i>North American Bryophyta</i>	344
CARDOT, J.— <i>Mexican Mosses</i>	345
PARIS, E. G.— <i>Moss-flora of the Isle of Pines</i>	345
" " <i>Chinese Muscineæ</i>	345
EVANS, A. W.— <i>Vegetative Reproduction in Metzgeria</i>	472
CUTTING, E. M.— <i>Androgynous Receptacles in Marchantia</i>	472

	PAGE
CAVERS, F.— <i>Inter-relationships of the Bryophyta</i>	172
COPPEY, A.— <i>Regeneration in the Hepaticæ</i>	172
DIXON, H. N.— <i>Some Irish Forms of Ptilidium</i>	173
CORNET, A.— <i>Revision of the Species of Philonotis</i>	173
THÉRIOT, A.— <i>Heterocladium Macounii</i>	171
BROECK, H. VAN DEN— <i>Belgian Forms of Harpidium</i>	174
HAYNES, C. C.— <i>Sphærocarpos</i>	174
GOFBEL, K.— <i>Monoselenium tenerum</i> Griffith	174
STEPHANI, F.— <i>Dendroceros</i>	175
WHELDON, J. A., & A. WILSON— <i>Scotch Bryophyta</i>	175
ARMITAGE, E.— <i>New Records of British Sphagna</i>	175
HAYNES, C. C., & OTHERS— <i>North American Bryophytes</i>	175
CARDOT, J.— <i>Mexican Mosses</i>	176
ARMITAGE, E.— <i>Hepaticæ of Madeira</i>	176
CUFINO, L.— <i>East African Mosses</i>	176
ANON. & M. A. HOWE— <i>Charles Reid Barnes (1858–1910)</i>	176
WADDELL, C. H.— <i>George Stabler and J. M. Barnes</i>	177
CARDOT, J.— <i>Sexuality in the Mosses</i>	163
STEVENS, N. E.— <i>Discoid Gemmæ in Foliose Hepatics</i>	164
DOUIN, I.— <i>Protonema and Propagules in Hepaticæ</i>	165
SCHIFFNER, V.— <i>Rhizoids of Marchantiales</i>	165
GARJEANNE, A. J. M.— <i>Luminosity of Moss Leaves</i>	166
GIESENHAGEN, K.— <i>Types of Tropical Mosses</i>	166
CAVERS, F.— <i>Inter-relationships of Bryophyta</i>	166
LOTSY, J. P.— <i>Primitive Form of the Liverworts</i>	167
MASSALONGO, B.— <i>Acoela and Marsupella</i>	167
SCHIFFNER, V.— <i>Chiloscyphus and Heteroscyphus</i>	167
" " <i>Bryological Notes</i>	167
ERNST, A.— <i>Ephemeropsis tibodensis</i>	168
DIXON, H. N.— <i>Cynodontium Jenneri</i>	168
TRAVIS, W. G.— <i>Ceratodon conicus</i>	168
LUISIER, A.— <i>What is Dicranoweisia robusta Vent?</i>	168
GYÖRFFY, I.— <i>Pohlia carnea in Transylvania</i>	169
DIXON, H. N.— <i>"Neolithic" Moss Remains</i>	169
MACVICAR, S. M.— <i>Scottish Hepaticæ</i>	169
STANSFIELD, A.— <i>Moss-flora of Tadmorden, Lancs.</i>	169
WHELDON, J. A.— <i>New Lancashire Mosses</i>	169
TRAVIS, W. G.— <i>Lancashire Hepatics</i>	110
WHELDON, J. A.— <i>Additions to the Munx Sphagna</i>	110
MEYLAN, C.— <i>Moss-flora of the Jura</i>	110
COPPEY, A.— <i>Moss-flora of the Haute-Saône</i>	110
GIL, A. CASARES— <i>Spanish Bryophytes</i>	110
HERZOG, T.— <i>Rare European Mosses</i>	111
MÜLLER, K.— <i>European Hepatics</i>	111
GROUT, A. J.— <i>North American Moss Book</i>	111
LORENZ, A., & OTHERS— <i>North American Bryophytes</i>	111
NICHOLS, G. E.— <i>Critical Mosses of New England</i>	111
KINDBERG, N. C.— <i>Canadian Mosses</i>	112
CARDOT, J.— <i>Mexican Mosses</i>	113
THÉRIOT, L.— <i>Bryophytes of New Caledonia</i>	113
OKAMURA, S.— <i>Japanese Bryophytes</i>	113
RÖLL, J.— <i>Specific Types versus Formenreihen</i>	113
" " <i>Specific Names of Sphagnum</i>	113
" " <i>Congress Notes</i>	113
ROTH, G.— <i>Moss Criticisms</i>	114
ARCHER, J.— <i>Hepatics and Contamination</i>	114
LOESKE, L.— <i>Phylogenetic Classification of Mosses</i>	735
KURSSANOW, L.— <i>Phylogeny of the Archegonium</i>	735
MÖNKEMEYER, W.— <i>Abnormal Capsules in Bryum argenteum</i>	735
LORCH, W.— <i>Mechanism of Leaf-movements in Polytrichaceæ</i>	735
CARDOT, J.— <i>Dicran loma</i>	736
SHEPPARD, T.— <i>Prehistoric Mosses from Lincolnshire</i>	736

	PAGE
INGHAM, W.— <i>Yorkshire Mosses</i>	736
MCANDREW, J.— <i>Pallavicinia Flotowiana in Scotland</i>	736
MACVICAR, S. M.— <i>Distribution of Hepaticæ in Scotland</i>	736
LETT, H. W.— <i>Bryophytes of Co. Donegal</i>	737
MÜLLER, K.— <i>European Hepaticæ</i>	737
LESDAIN, BOULY DE— <i>Bryophytes of Dunkerque</i>	737
COPEY, A.— <i>Moss-flora of the Haute-Saône</i>	737
DIETZOW, L.— <i>Prussian Mosses</i>	737
CULMANN, P.— <i>Swiss Mosses</i>	737
GUINET, A.— <i>Geneva Mosses</i>	738
BOTTINI, A.— <i>Mosses of the Italian Islands</i>	738
FRYE, T. C.— <i>Polytrichaceæ of Western North America</i>	738
BROTHERUS, V. F.— <i>Philippine Mosses</i>	738
DIXON, H. N., & OTHERS— <i>Mosses of Western India</i>	738
RENAULD, F.— <i>Mosses of Madagascar</i>	739
CARDOT, J.— <i>Antarctic Mosses</i>	739
ROSS, H.— <i>Otto Sealtner</i>	739
HUSNOT, T.— <i>P. J. F. Gravet</i>	739
THÉRIOT, I.— <i>F. Renauld</i>	739

Thallophyta.

Algæ.

ACTON, E.— <i>Coccomyxa subellipsoidea, a New Member of the Palmellaceæ</i>	61
PEEBLES, F.— <i>Spherella loustris</i>	62
SCHMULA— <i>Scenedesmus</i>	62
COLLINS, F. S.— <i>Algological Prophecy Fulfilled</i>	63
WEST, W. & G. S.— <i>Phytoplankton of the English Lake District</i>	63
TONI, G. B. DE, & A. FORTI— <i>Fresh-water Algæ from Ruwenzori</i>	64
SCHILLER, J.— <i>Microspore-formation in Chætoceras Lorenzianum</i>	64
BLOOMFIELD, E. N.— <i>Algæ of Suffolk and Norfolk</i>	65
KOLKWITZ, R., & A. ELENKIN— <i>Fresh-water Plankton</i>	65
BENECKE, W.— <i>Periodicity of Algæ</i>	65
BERNARD, C.— <i>Fresh-water Algæ from the Malay Region</i>	66
WEST, W.— <i>Some Fresh-water Algæ of Fiji</i>	66
PHILIP, R. H.— <i>Interesting Diatom near Hull</i>	66
OSTENFELD, C. H.— <i>Biddulphia sinensis</i>	66
KINDLE, E. M.— <i>Diatomaceous Dust on the Behring Sea Ice-floes</i>	67
RICHTER, O.— <i>Physiology of Diatoms</i>	67
SAUVAGEAU, C.— <i>Halopteris scoparia and Sphacelaria radicans</i>	67
" " <i>Colpomenia sinuosa</i>	68
YENDO, K.— <i>Mucilage-glands of Undaria</i>	68
YAMANOUCHI, S.— <i>Cytology of Cutleria und Aglaozonia</i>	69
TARARA, M.— <i>Oospheres in Sargassum</i>	69
BØRGESEN, F.— <i>West Indian Floridææ</i>	69
BRAND, F.— <i>Fresh-water Species of Chætrotransia</i>	70
LEWIS, I. F.— <i>Griffithsia Bornetiana</i>	70
FOSLIE, M.— <i>Corallinaceæ</i>	71
HAYRÉN, E.— <i>Finland Algæ</i>	72
BIBLIOGRAPHY	72
HANSON, E. K.— <i>Phycocrythrin</i>	195
SAUVAGEAU, C.— <i>Hybrid Fucus</i>	196
TOBLER, F.— <i>Epiphytes of Laminaria</i>	196
DREW, G. H.— <i>Laminaria digitata and L. suecharina</i>	196
HOYT, W. D.— <i>Dictyota dichotoma</i>	197
WOYCICKI, Z.— <i>Laboratory Cultures under Gas</i>	197
SAUVAGEAU, C.— <i>Naturalisation of Algæ</i>	198
" " <i>Marine Algæ and Currents</i>	198
NIEUWLAND, J. A.— <i>Hints on Collecting and Growing Algæ</i>	198
HOLMES, E. M.— <i>British Marine Algæ</i>	199
GRIEVE, S.— <i>Marine Algæ of Dominica</i>	199
OKAMURA, K.— <i>Japanese Algæ</i>	199
FRITSCH, F. E., & F. RICH— <i>Fresh-water Algæ in Nature</i>	199

	PAGE
WILLE, N.— <i>Supplement to Engler's Pflanzenfamilien</i>	200
CZAPKÉ, F.— <i>Indian Ocean Plankton</i>	200
OSTENFELD, C. H.— <i>Phytoplankton of Victoria Nyanza</i>	201
" " <i>Swiss Plankton</i>	201
VIRET, L.— <i>Desmids</i>	201
BESSELL, J. B.— <i>Devonshire Diatoms</i>	201
OSTENFELD, C. H.— <i>Biddulphia sinensis in the North Sea</i>	201
HÉRIBAUD, J.— <i>Fossil Diatoms</i>	202
BIALOSUKNIA, W.— <i>New Genus of Pleurococcaceæ</i>	202
GUGLIELMETTI, G.— <i>Protococcaceæ</i>	202
TSCHOURLINA, O.— <i>Astroclodium cerastioides</i>	202
NIEUWLAND, J. A.—"Knee-joint" of <i>Mougeotia</i>	203
VIRET, L.— <i>Algæ of Haute-Savoie</i>	203
PASCHER, A.— <i>Chryomonadinæ of Bohemia</i>	203
" " <i>New Genus of Chryomonadinæ</i>	203
GROBÉTY, A. E.— <i>Ourococcus bicaudatus</i>	203
CHODAT, R.— <i>Green Snow</i>	203
SENN, G.— <i>Oxyrrhis marina</i>	204
ROTHPLETZ, A.— <i>Fossil Algæ</i>	204
GUÉGUEN, F.— <i>Brothers Crown</i>	204
DE TONI, G. B.— <i>M. H. Fostie</i>	205
BIBLIOGRAPHY	205
HOLMES, E. M.— <i>British Algæ</i>	346
SOMMIER, S.— <i>Italian Algæ</i>	346
HOWE, M. A.— <i>Marine Algæ of Panama</i>	346
" " <i>West Indian Marine Algæ</i>	346
OKAMURA, K.— <i>Japanese Algæ</i>	346
PASCHER, A.— <i>Three new Chryomonads</i>	346
JACOBSEN, H. C.— <i>Folvocaceæ</i>	346
GEORGEVITCH, P.— <i>Serbian Desmids</i>	347
" " <i>Desmids from Macedonia</i>	347
ZIMMERMANN, C.— <i>Catalogue of Portuguese Diatoms</i>	347
" " <i>Diatoms of Madeira and Port Santo</i>	347
KAISER, P. E.— <i>Vaucheria synandra</i>	348
TÖBLER, F.— <i>Saccorhiza bulbosa</i>	348
BAKER, S. M.— <i>Zoning of Brown Seaweeds</i>	348
THOMPSON, E. I.— <i>Tenionia</i>	349
CHODAT, R.— <i>Polymorphism of Algæ</i>	349
BIBLIOGRAPHY	349
CHALON, J.— <i>The Roscoff Laboratory</i>	477
BÖRGESEN, F.— <i>Greenland Fresh-water Algæ</i>	477
ROSENVINGE, L. K.— <i>Marine Algæ from North-east Greenland</i>	478
SZAFER, W.— <i>Sulphur-flora of Lemberg</i>	478
BRUNNTHALER, J.— <i>Glæothecæ rupestris</i>	478
WERNER, E.— <i>Ceratinum hirundinella</i>	478
LUTMAN, B. F.— <i>Closterium</i>	478
BRAND, F.— <i>Trentepohlia</i>	479
NIEBURG, W.— <i>Cystosira and Sargassum</i>	479
BÖRGESEN, F.— <i>West Indian Floridææ</i>	480
MENZ, J.— <i>Secondary Attachment in Floridææ</i>	480
BOSSE, A. WEBER VAN— <i>Symbiosis between Algæ and Sponges</i>	480
CAYEUX, L.— <i>Fossil Algæ</i>	181
BONNET, A.— <i>Fixing of Algæ</i>	614
GARDNER, N. L.— <i>Leuvenia, a New Genus of Flagellates</i>	614
YENDO, K., & K. AKATSUKA— <i>Asexual Mode of Auxospore Formation</i>	615
RICHTER, O.— <i>Physiology of Diatoms</i>	615
PHILIP, R. H.— <i>Diatoms of the Sedbergh District</i>	615
MÜLLER, O.— <i>Bacillariaceæ from Nyussu Land</i>	616
CAYEUX, L.— <i>Calcareous Phosphates composed of Diatoms</i>	616
LAMBERT, F. D.— <i>Characium</i>	616
" " <i>Coleocistæte</i>	616
FIGDOR, W., & E. WULFF— <i>Dasycladus clavæformis</i>	616

	PAGE
DESROCHE, P.— <i>Vaucheria</i>	617
JANSE, J. M.— <i>Charlserpa prolifera</i>	617
LEWIS, I. F.— <i>Periodicity in Dictyota at Naples</i>	618
WILLE, N.— <i>Himantothalia lorea</i>	618
MURRAY, H.— <i>Compsopojon</i>	619
WILSON, H. L.— <i>New Parasite on Gracilaria confervoides</i>	619
LEMOINE, P.— <i>Lithothamnium calcareum</i>	619
ADAMS, J., & A. D. COTTON— <i>Irish Algae</i>	620
HOWE, M. A.— <i>Algae of Panama</i>	620
LEMMERMANN, E.— <i>Algae of Brandenburg</i>	620
HUSTEDT, F.— <i>Flora of Bremen</i>	621
GUTWINSKI, R.— <i>Algae of the Tatra Mountains</i>	621
STOCKMAYER, S.— <i>Algae of Trebizond</i>	621
WORONICHIN, N. N.— <i>Black Sea Algae</i>	621
ELENKIN, A. A.— <i>Russian Fresh-water Algae</i>	621
OKAMURA, K.— <i>Japanese Algae</i>	622
HOLLICK, A.— <i>New Fossil Fucoid</i>	622
BIBLIOGRAPHY	622
DAVIS, B. M.— <i>Sexual Reproduction in Algae</i>	740
VIRIEUX, J.— <i>Sheath and Mucilage of Fresh-water Algae</i>	740
LAUTERBORN, R.— <i>Vegetat on of the Upper Rhine</i>	741
BERNARD, C.— <i>Fresh-water Algae of Dutch New Guinea</i>	741
PASCHER, A.— <i>Formation of Colonies in Flagellate</i>	741
MORTENSEN, TH., & I. K. ROSENVINGE— <i>New Parasitic Alga</i>	742
FRITSCH, F. E.— <i>Phylogeny and Inter-relationship of the Green Algae</i>	742
PALMER, T. C.— <i>Staurois Terryi</i>	742
" " <i>New Diatom</i>	743
HATE, V. N.— <i>Bombay Characeae</i>	743
NORDHAUSEN, M.— <i>Cryptostomata and Conceptacles of Fucus vesiculosus</i>	743
KYLIN, H.— <i>New Batrachospermum</i>	743
EDDELBÜTTEL, H.— <i>Parasitic Floridæe</i>	743
LAING, R. M.— <i>Algae of Auckland and Chatham Islands</i>	744

Fungi.

NAKAZAWA, R.— <i>Rhizopus Batatas, a New Koji Fungus</i>	72
ATKINSON, G. F.— <i>Evolution of the Lower Fungi</i>	72
ROUSSY, A.— <i>Development of Fungi on Fatty Substances</i>	73
COKER, W. C.— <i>Leptolequia from North Carolina</i>	73
ATKINSON, G. F.— <i>Fungus Parasites of Algae</i>	73
BROOKS, W. E., & H. C. I. FRASER— <i>Cytology of the Ascus</i>	74
SCHIKORRA— <i>Development of Monascus</i>	74
JUEL, O.— <i>Species of Taphrina on Betula</i>	75
FOEX, E.— <i>Oöliopsis taurica</i>	75
GUILLIERMOND— <i>Notes on Phylogenesis in Yeasts</i>	75
LINDAU, G.— <i>Hypomyces</i>	75
SCHMIDT, ERNEST W.— <i>Ædocephalum glomerulosum, the Conidial Form of Pyronema oomphalodes</i>	75
ARTHUR, J. C., & OTHERS— <i>Uredineæ</i>	76
BREFELD & HECKE— <i>Smut Infection of Wheat and Barley</i>	76
RACIBORSKIL, M., & R. LAUBERT— <i>Exobasidium on Azalea</i>	77
MAIRE, RENÉ— <i>Podocycpha undulata</i>	77
ATKINSON, G. F., & OTHERS— <i>Notes on the Larger Fungi</i>	77
BAMBEKE, CH. VAN— <i>Deformation of the Egg of Mutinus caninus</i>	78
HARD, M. E.— <i>Mushrooms, Edible and otherwise</i>	78
LOYD, C. G., & CH. BERNARD— <i>Synopsis of Phalloids</i>	78
HÖHNEL, FR. V.— <i>Mycological Fragments</i>	78
LOYD, C. G.— <i>Mycological Notes. No. 33</i>	78
BARTETZKO, HUGO— <i>Freezing of Filamentous Fungi</i>	78
ESCHERICHI, K.— <i>Termites and Fungus-culture</i>	79
CLEMENTS, F. E.— <i>Genera of Fungi</i>	79
SELBY, A. D., & OTHERS— <i>Diseases of Plants</i>	79

	PAGE
BURGEFF, HANS— <i>Root-fungi of Orchids</i>	82
BIBLIOGRAPHY	82
PERCIVAL, JOHN— <i>Life-history and Cytology of Potato-wart Disease</i>	205
MANGIN, L.— <i>Aspergillus glaucus</i>	206
GUILLIERMOND, A.— <i>Study of Eulomyces</i>	206
WAGER, H., & A. PENISTON— <i>Cytological Observations on the Yeast Plant</i>	207
BUBÁK, F., & OTHERS— <i>Notes on Tilletia</i>	208
KRIEG, W., & OTHERS— <i>Uredineæ</i>	208
STAMPFLI, RUTH— <i>Deformations caused by Uredineæ</i>	209
KOLKOWITZ, R., & E. JAHN— <i>Fungi of Brandenburg</i>	209
MERRILL, W. A., & OTHERS— <i>Notes on some Larger Fungi</i>	209
HERPELL, GUSTAV— <i>Larger Fungi of Rhine-land</i>	211
MIGULA, W.— <i>German Fungus-flora</i>	211
HÖHNEL, FRANZ V.— <i>Mycological Notes</i>	211
ROLLAND, L.— <i>Atlas of Fungi</i>	211
GUÉGUEN, F.— <i>Poisonous and Edible Fungi</i>	211
WOLFF, A.— <i>Microfungi in Cheese Curds</i>	211
GERBER, C.— <i>Chemical Study of Fungus Cell-sap</i>	212
PRINGSHEIM & ZEMPTEN— <i>Ferments of Fungi</i>	212
KOMINAMI, K.— <i>Biological Experiments with Fungi</i>	212
CHITTENDEN, F. J., & OTHERS— <i>Plant Diseases</i>	212
ZACH, FRANZ— <i>Mycorrhiza of Sempervivum</i>	216
BIBLIOGRAPHY	216
RAYBAUD, L.— <i>Experiments with Mucorini</i>	349
KORFF— <i>Urophlyctis Alfatæ</i>	350
McCUBBIN, W. A.— <i>Development of Helvella elastica</i>	350
HEALD, F. D., & F. A. WOLF— <i>Systematic Position of Urula Geaster</i>	350
HARDER, E.— <i>Xylaria Hypoxylon</i>	350
SEEVER, F. J.— <i>American Hypocreales. III.</i>	350
BAINIER, G.— <i>Study of Chaetium</i>	351
GUILLIERMOND, A.— <i>Cytology of Yeasts</i>	351
BACCARINI, P.— <i>Development of Lasiodiplodia florii sp. n.</i>	351
VUILLEMIN, P.— <i>Classification of Hyphomycetes</i>	351
LINDAU, G.— <i>Hyphomycetes</i>	352
BURRI, R., & W. STAUB— <i>Black Spot in Cheese</i>	352
TRANZSHEL, W.— <i>Uredineæ</i>	352
GUÉGUEN, FERDINAND— <i>Notes on the Larger Fungi</i>	352
BEAUVÉRIE, J.— <i>Merulius larymans</i>	353
WAKEFIELD, E.— <i>Experiments on Higher Fungi</i>	353
FERRARIS, T.— <i>Italian Cryptogamic Flora</i>	354
MURRILL, W. A.— <i>Protection of Shade Trees against Attacks of Fungi</i>	354
LLOYD, C. G.— <i>Mycological Notes, No. 34</i>	354
SAITO, K.— <i>Fermentation Fungi from Korea</i>	354
JUMELLI, HENRI, & H. PERRIER DE LA BATHIE— <i>Fungi of Termites' Nests</i>	354
EWERT— <i>Wintering of Fungus Spores</i>	355
BUTIGNOT, ED., & A. SARTORY— <i>Poisonous Fungi</i>	355
POTEBNIA, A.— <i>Contribution to the Micro-fungus Flora of Central Russia</i>	355
SPEGAZZINI, C.— <i>Argentine Fungi</i>	355
BIGEARD, R., & OTHERS— <i>French Fungus Flora</i>	356
MATRUCHOT, LOUIS— <i>Pathogenic Fungi</i>	356
GRIFFON & OTHERS— <i>Plant Diseases</i>	356
BIBLIOGRAPHY	358
GRIGGS, R. F.— <i>New Genus of Clytridineæ</i>	481
McALPINE, D.— <i>Phytophthora infestans</i>	481
BUCHOLTZ, FEODOR— <i>Study of Balsamineæ</i>	482
BOYER, G.— <i>Development of Truffles</i>	482
STAGER, ROB.— <i>New Observations on Ergot</i>	482
GRIFFON & MAUBLANC— <i>Oak Mistle</i>	482
NAMYSLOWSKI, BOLESŁAW— <i>Two Epidemic Mistle Diseases</i>	482
FREEMAN, D. LINFORD— <i>Stroma-formation in Xylaria Hypoxylon</i>	483
GUILLIERMOND, A.— <i>Critical Notes on Yeast Researches</i>	483
LINDAU, G.— <i>Hyphomycetes</i>	483

	PAGE
COUPIN, HENRI— <i>Growths of Moulds in Oil</i>	484
MORGENTHALER, O.— <i>Uredinæ</i>	484
KURSSANOW, L.— <i>Sexuality of Rust Fungi</i>	484
BUBAK, FR.— <i>Ustilago bulgarica</i> sp. n.	485
MAIRE, R.— <i>Classification of Russulæ</i>	485
FISCHER, C. E. C.— <i>Armillaria mucida</i>	485
KNOLL, FRITZ— <i>Geotropism and Growth in Length of Coprinus striatiacus</i>	485
SCHAFFNIT, E.— <i>Contiophora cerebella</i> as <i>Timber Destroyer</i>	485
PETCH, T.— <i>Fomes lucidus</i> , a <i>Root-disease of the Coconut Palm</i>	486
MASSEÉ, G., & OTHERS— <i>Notes on the Larger Fungi</i>	486
ZIKES, H.— <i>Assimilation of Nitrogen by Yeast Fungus</i>	486
LLOYD, C. G.— <i>Mycological Notes</i>	486
HÖHNEL, F. VON— <i>New or Critical Fungi</i>	486
BOYD, D. A.— <i>Fungi of the Clyde Area</i>	487
CAPPEN, H.— <i>Breaking up of Cyanamides by Fungi</i>	487
MASSEÉ, G.— <i>Text-book of Plant Diseases</i>	487
BUBAK, FR.— <i>Phytophthora Disease of Pears</i>	487
BROOKS, F. T., & A. W. BARTLETT— <i>Two Diseases of Gooseberry Bushes</i>	488
FALCK, R.— <i>Disease of Pine Wood</i>	488
SALMON, E. S., & OTHERS— <i>Plant Diseases</i>	488
BEQUEREL, PAUL— <i>Vitality of Spores</i>	491
BEAUVENIE, J.— <i>Ambrosia Fungi</i>	492
POTTER & OTHERS— <i>British Mycology</i>	492
BOULET, VITAL— <i>Mycorhiza of Fruit-trees</i>	493
BIBLIOGRAPHY	493
HOOD, OLIVE— <i>New Chytridiaceous Fungus</i>	622
PETERSEN, H. E.— <i>Fresh-water Phycomycetes</i>	622
KRUGER, FRITZ— <i>Cytology of Albugo candida and Peronospora Ficiaria</i>	622
VIALA, P., & P. PACOTTET— <i>Vine Roestelia</i>	623
EDGERTON, C. W.— <i>Trochila Populorum</i>	623
SEEVER, F. J., & E. D. CLARK— <i>Studies in Pyrophilous Fungi</i>	623
BUCHANAN, R. E., & CHARLES E. LEWIS— <i>Monascus</i>	624
SEEVER, F. J.— <i>North American Hypocreales. II.</i>	624
KLEIN, E. J.— <i>Oak-mildew</i>	624
GUILLEMOND, A.— <i>Division of Yeast-cells</i>	624
GEIGER, ARTHUR— <i>Study of Torula Fungi</i>	625
PÉNAU, HENRY— <i>Yeast-cells of Endomyces albicans</i>	625
SMITH, W. STANLEY— <i>Functions of Yeast</i>	625
VOGES, ERNST— <i>Systematic Study of Hendersonia</i>	625
THOM, CH.— <i>Culture Studies of Species of Penicillium</i>	625
FAWCETT, H. S.— <i>Important Entomogenous Fungi</i>	626
LINDA COM, G.— <i>Hyphomycetes</i>	626
KERN, F. D.— <i>Peridial Cells in the Roestelia</i>	626
FABER, F. C. VON— <i>Germination of Uredospores of Hemileia vastatrix</i>	626
PAYOLINI, A. F.— <i>Development of the Æcidium</i>	627
TRANZSCHEL, W.— <i>Uredinæ</i>	627
SMITH, W. G.— <i>Coloured Drawings of Mushrooms, edible and poisonous</i>	627
STORER, WILMER G., & OTHERS— <i>Notes on the Larger Fungi</i>	628
FORD, W. W.— <i>Distribution of Poisons in Mushrooms</i>	628
SPAGAZZINI, C.— <i>Chilian Fungi</i>	628
RANOJEVIC, N.— <i>Serbian Fungi</i>	628
ADAMS, J., & G. H. PETHYBRIDGE— <i>Catalogue of Irish Fungi</i>	629
FELDINANDSEN, C., & O. WINGE— <i>Mycological Notes. II.</i>	629
BEAUVENIE, J.— <i>Ambrosia Fungi</i>	629
HOLDRUNG, M.— <i>Review of Plant Diseases</i>	629
DOGGAR, B. M.— <i>American Text-book of Plant Diseases</i>	630
PARKER, J. B., & OTHERS— <i>Plant Diseases</i>	630
BIBLIOGRAPHY	631
OBEL, P.— <i>Formation of Oogonia in Achlya</i>	744
KORPACHEWSKA, IRÈNE— <i>Study of Heterothallic Mucorini</i>	744
LEWIS, CH. E.— <i>Endomyces on Apples</i>	745
PIEDALLER, ANDRÉ— <i>New Species of Monascus</i>	745

	PAGE
SETCHELL, W. A.— <i>Sphaerosoma</i>	745
WHELDON, J. A.— <i>New Lancashire Cryptogams</i>	745
BROOKS, F. T.— <i>Development of Gnomonia erythrostoma</i>	745
HEALD, F. D., & F. A. WOLF— <i>Whitening of the Mountain Cedar, Sabina sabinoides</i>	746
ERIKSSON, J.— <i>Mildew of Apples</i>	746
ERIKSSON, J., & A. LEMCKE— <i>American Gooseberry Mildew</i>	746
FISCHER, ED., & E. BARSALI— <i>Oak Mildew</i>	747
GUILLIERMOND, A.— <i>Notes on Yeast-cells</i>	747
PRINGSHEIM, E., & H. BILEWSKY— <i>Red Yeast</i>	747
JACZEWSKI, A. VON, & OTHERS— <i>Uredinæ</i>	747
BUTLER, E. J.— <i>New Genus of Uredinaceæ</i>	748
ILKEWITSCH, KONSTANTIN, & OTHERS— <i>Wood-destroying Fungi</i>	748
WHELDON, H. J.— <i>Key to the British Agaricaceæ</i>	749
MIGULA, W.— <i>German Fungus Flora</i>	749
MASSART, JEAN— <i>Fairy Rings</i>	749
BOURDGT, H., & OTHERS— <i>Notes on Larger Fungi</i>	749
COOKE, M. C.— <i>British Basidiomycetes</i>	750
FAWCETT, H. S., & W. C. COKER— <i>Notes on Microfungi</i>	750
ARNAUD, G.— <i>Study of Fumagine Fungi</i>	750
ROTHMAYR, JULIUS— <i>Popular Account of Fungi</i>	750
SMITH, THOS.— <i>Plea for the Study of Fungi</i>	750
GRANDJEAN, MARIUS— <i>Edible Fungi</i>	751
BUTIGNOT, ED., & W. W. FORD— <i>Poisonous Fungi</i>	751
TAURET, C.— <i>Relations between Callose and Fungose</i>	751
BERTRAND, G., & ROSENBLATT— <i>Resistance of Vegetable Tyrosinases to High</i> <i>Temperatures</i>	751
HARPER, R. A.— <i>Nuclear Phenomena of Sexual Reproduction in Fungi</i>	751
FABER, E. VON, & OTHERS— <i>Plant Diseases</i>	752
GERSTLAUER, L.— <i>Max Britzelmayr</i>	753
BIBLIOGRAPHY	753

Lichens.

ZAHLBRUCKNER, A.— <i>New Lichens</i>	84
MAIRE, RENÉ— <i>Lichens from Greece</i>	84
DARBISHIRE, OTTO V.— <i>Arctic Lichens</i>	84
WAINIO, E. A.— <i>Siberian Lichens</i>	85
ZOPF— <i>Chemistry of Lichens</i>	85
BIBLIOGRAPHY	85
ZSACKE, H.— <i>Lichen Flora of the Saal Valley</i>	218
ELENKIN— <i>Russian Lichens</i>	218
ZAHLBRUCKNER, A.— <i>Lichens from Brazil</i>	218
JATTA, A.— <i>Italian Lichens</i>	218
ACTON, ELIZABETH— <i>Primitive Lichen</i>	219
SCHIFFNER, V.— <i>Useful Plants among Lichens</i>	219
SIEVERS, F.— <i>Absorption of Water by Lichens</i>	219
BIBLIOGRAPHY	220
NAVAS, L.— <i>Lichens of the Azores</i>	359
BIBLIOGRAPHY	360
DANILOV, U. N.— <i>Relation between Gonidia and Hyphæ in Lichens</i>	494
NAVAS, P. LONGINOS— <i>Lichens of Aragon</i>	495
BLOOMFIELD, E. N.— <i>Lecidea-mougeotioides</i> Schaer. in Britain	495
BIBLIOGRAPHY	495
SERRET, MIR— <i>Lichen-flora of Bohemia and Moravia</i>	633
BIBLIOGRAPHY	634
LESDAIN, M. BOULY DE— <i>Study of the Lichens of Dunkerque</i>	755
HUE— <i>Variation of Gonidia in the Genus Solorina</i>	755
FITTING, HANS— <i>Epiphytic Lichens</i>	755
WHELDON, J. A.— <i>New Lancashire Cryptogams</i>	756
FINK, BRUCE— <i>Lichens of Minnesota</i>	756
BIBLIOGRAPHY	756

	PAGE
TORREND, C.— <i>Text-Book of Mycetozoa</i>	220
BLOMFELD, J. E., & E. J. SCHWARTZ— <i>Mycetozoon Parasites</i>	221
PETCH, T.— <i>Mycetozoa of Ceylon</i>	360
BIBLIOGRAPHY	360
JAAP, O.— <i>Myzomyces of Brandenburg</i>	496
MARCHAND, ERNEST F. L.— <i>Plasmodiophora Brassicæ</i>	496
GROVE, W. B.— <i>Mycetozoa of the Midland Plateau</i>	634
MAIRE, RENÉ, & ADRIEN TISON— <i>Plasmodiophoraceæ</i>	634
MOORE, CLARENCE L.— <i>Mycetozoa of Pictou County</i>	756
HILTON, A. E.— <i>British Mycetozoa</i>	802

Schizophyta.

Schizomycetes.

FANTHAM, H. B., & ANNIE PORTER— <i>Bacillus arenicolæ</i>	86
VAX, F.— <i>Granules of Plague Bacilli</i>	86
BAUDRAN— <i>Media which Attenuate or Exalt the Virulence of Tubercle Bacilli</i>	86
WERNER, H.— <i>Spirochæta eurygyrata and S. stenogyrata</i>	86
SARTORY, A., & A. FILASSIER— <i>Microbes on Fruit</i>	86
NAMYŚŁOWSKI, B.— <i>Actinomyces of the Cornea</i>	86
WEST, G. S.— <i>Hillhousia mirabilis</i>	87
MEISSNER & TRAPP— <i>Fixation of the Complement in Glanders</i>	87
RUATA, V.— <i>Cocccobacillus conjunctivæ</i>	87
MEHLHOSE, R.— <i>Presence of Bacteria in Echinococci and Cysticerci</i>	87
FURMAN, F.— <i>Flagella of Spirillum volutans</i>	88
OSTERWALDER, A.— <i>Causes of certain Plant Diseases</i>	88
VAHLE, C.— <i>Comparative Studies of the Myzobacteriaceæ and the Bacteriaceæ</i>	88
XYLANDER— <i>Relation of the Ratin-bacillus to the Bacilli of the Gaertner Group</i>	89
WHITE, B., & O. T. AVERY— <i>Observations on certain Lactic Acid Bacteria of the so-called Bulgarian type</i>	89
FROSCH, P., & K. BIERBAUM— <i>Bacillus septicevmitæ anserum exsudativæ</i>	90
BIBLIOGRAPHY	90
HUSS, H.— <i>New Bacillus in Cheese</i>	221
CHATTERJEE, G. C.— <i>New Lactic-acid Streptothrix</i>	221
GUILLEMARD, ALFRED— <i>Resistance of various Bacteria to Alterations in Osmotic Pressure</i>	222
CHIAROLANZA, R.— <i>Comparative Study of Streptothrix pyogenes and Actinomyces hominis</i>	222
PROCA, G., & P. DANILA— <i>Cladothrix stereotropa</i>	222
REPACI, G.— <i>Streptobacillus niger gangræne pulmonaris</i>	222
MELIKOV, B. L.— <i>Spores of Bacillus perfringens</i>	223
BIBLIOGRAPHY	223
GALLEOTTI, G., & E. LEVI— <i>Bacterial Flora in the Ice of Monte Rosa</i>	361
BORDET, J.— <i>Morphology of the Microbe of Peripneumonia of Cattle</i>	361
MAKINOFF, S.— <i>Bacillus bulgaricus vel B. lactis acidî Leichmann</i>	361
REPACI, G.— <i>Bacillus mouliiformis</i>	361
CONOR, A.— <i>Micrococcus melitensis and Malta Fever</i>	361
LIPMAN, J. G., & P. E. BROWN— <i>Quantitative Estimation of Soil Bacteria</i>	362
FISCHER, HUGO— <i>Media for Enumeration of Bacteria in Soil</i>	362
REVIS, C.— <i>Stability of the Physiological Properties of Coliform Organisms</i>	362
KÜHNEMANN— <i>Morphological Differentiation of Bacillus paratyphosus and Bacillus typhosus</i>	363
STRUBELL & FELDER— <i>Tuberculo-opsonic Index in Man and in Cattle</i>	363
LAVEN, L.— <i>New Pathogenic Cocccobacillus</i>	363
OHNO, Y. K.— <i>Morphology of Cholera Vibrios in Peptone Solutions of Different Reactions</i>	364

	PAGE
ROSENTHAL, G.— <i>Antagonism of Bacillus bulgaricus and Bacillus diphtheriæ</i>	364
CHATTERJEE, G. C.— <i>New Bacillus of Fowl-septicæmia</i>	364
REPACI, G.— <i>New Anaerobic Streptococcus</i>	364
PROCA, G.— <i>Cladothrix vaccinæ</i>	365
ELLIS, DAVID— <i>Further Study of New Iron-bacteria</i>	365
BIBLIOGRAPHY	365
STONE, G. E.— <i>Electricity and Micro-organisms</i>	496
EJIKMAN, C.— <i>Investigations on Disinfection</i>	497
BABES, V.— <i>Metachromatic Granules in Acid-fast Bacilli</i>	497
BOUČEK, Z.— <i>New Bacillus of the Hæmorrhagic Septicæmia Group</i>	497
BETEGH, L. VON— <i>Tuberculosis in Salt-water Fish</i>	497
MAZÉ, P.— <i>Scientific Cheesemaking</i>	498
KÜHL, H.— <i>Cultivation of Mould from Rancid Butter</i>	499
SPIECKERMANN, A.— <i>Bacterial Disease of Potatoes</i>	499
JOHNSON, T.— <i>Bacterial Rot in Turnips</i>	499
GEORGEVITCH, P.— <i>New Species of Thermophilic Bacilli</i>	500
WEHRLI & OTHERS— <i>Acid-fast and Granular Types of Tubercle Bacilli</i>	500
SPENGLER, C.— <i>New Type of Tubercle Bacillus</i>	501
BERTARELLI, E., & G. BOCCHIA— <i>Tuberculosis in Cold-blooded Animals</i>	501
ARZT, L.— <i>Streptococcus mucosus</i>	501
SANGIORGI, G.— <i>Appearance found in certain Bacteria when Examined by the Indian-ink Method</i>	635
PENNINGTON, MARY E.— <i>Chemical and Bacteriological Study of Fresh Eggs</i>	635
BERNARD, P. N.— <i>Endotoxin of Micrococcus melitensis</i>	635
GAGE, G. E.— <i>Biological and Chemical Studies of Nitroso-bacteria</i>	635
VERDERAME, P.— <i>Gram-negative Cocci from the Human Conjunctiva</i>	636
GAERTNER, A.— <i>Disease of Sheep caused by a Lanceolate Diplococcus</i>	636
GALLI-VALERIO, B.— <i>Germs in Mountain Air</i>	636
DOLD, H.— <i>Bottle-bacillus</i>	636
FRÄNKEL, E., & E. PIELSTICKER— <i>Bacterium anthroposepticum</i>	637
ZIKES, H.— <i>Bacterial Parasites of Barley</i>	637
BABES, V., & T. MINONESCU— <i>New Variety of Mycosis occurring in Man</i>	637
PREDTJETSCHENSKY, W.— <i>Bacillus of Typhus Fever</i>	638
MAZÉ, P.— <i>Scientific Cheese-making</i>	638
BIBLIOGRAPHY	639
MAZÉ, P.— <i>Scientific Cheese-making</i>	757
GORINI, C.— <i>Rennet-forming Cocci in Cheese</i>	757
GREIG-SMITH, R.— <i>Bacterial Flora of Rachitic Stools</i>	757
<i>Slime Bacteria on Sponges</i>	757
JACQUÉ, L., & F. MASAY— <i>Streptobacterium fetidum</i>	758
BROQUET, C.— <i>Red Disease of Silkworm Moth</i>	758
BORDET, T., & V. FALLY— <i>Microbe of Fowl Diphtheria</i>	758
FISCHER, H.— <i>Recent Researches on Soil Bacteriology</i>	758
BIBLIOGRAPHY	759

MICROSCOPY.

A. Instruments, Accessories, etc.

	PAGE
(1) Stands.	
EWELL, M. D.— <i>Convenient Form of Stand for use as a Micro-colorimeter and with the Micro-spectroscope</i> (Figs. 2-4)	14
ZEISS' <i>Microscope for Investigating Ultra-microscopical Particles</i> (Fig. 5)	91
BIBLIOGRAPHY	92
WATSON'S <i>Naturalist's Microscope</i> (Figs. 18, 19)	224
HENKER, O., & M. VON ROHR— <i>Binocular Loups of Weak and Medium Magnification</i>	225
DOELTER, C.— <i>New Heat Microscope</i> (Fig. 47)	366
WRIGHT, F. E.— <i>New Petrographic Microscope</i> (Figs. 53-56)	502
WATSON & SONS' " <i>Advanced</i> " <i>Petrological Microscope</i> (Figs. 57, 58)	506
BIBLIOGRAPHY	508
MILLER-WILLIAMS, E. B.— <i>On a New Fine-adjustment for Body and Sub-stage of Microscopes</i>	535
OLD <i>Achromatic Microscope by Trécourt and Georges Oberhaeuser</i> (Fig. 78)	640
OLD <i>Microscope presented by Mr. Albert Ash</i> (Fig. 79)	642
OLD <i>Microscope presented by Mr. C. F. Rousset</i> (Fig. 80)	642
JOHANNSEN, A.— <i>Simple Improvements for a Petrographical Microscope</i> (Figs. 81-84)	643
WATSON & SONS' " <i>Royal</i> " <i>Microscope</i> (Figs. 85-87)	646
QUIDOR-NACHET <i>Microscope</i> (Fig. 88 and Pl. XII.)	649
BIBLIOGRAPHY	650
BORROW, R.— <i>Useful Microscope Device</i> (Fig. 106)	760
NEISSER, M.— <i>Bacteriological Demonstration Table</i>	761
(2) Eye-pieces and Objectives.	
WATSON'S $1/6$ and $1/12$ <i>Objectives</i> (Figs. 20, 21)	226
WRIGHT, F. E.— <i>New Petrographic Ocular</i> (Figs. 59-70)	508
WATSON & SONS' <i>Parachromatic Objectives</i> (Fig. 89)	651
(3) Illuminating and other Apparatus.	
BECK-GORDON <i>Speculum Lamp</i> (Fig. 6)	92
BARRETT, W. T.— <i>New Form of Polarimeter for the Measurement of the Refractive Index of Opaque Bodies</i> (Figs. 7, 8)	93
PRINGSHEIM'S <i>Yellow Filters</i> (Figs. 9-11)	96
S.C.A.— <i>Dark-ground Illumination</i> (Fig. 12)	98
HARDING, C. F.— <i>Use of the Polariscopes in Testing High-tension Insulators</i>	98
BIBLIOGRAPHY	99
ZEHNDER'S <i>New Half-shadow Polarimeter</i> (Fig. 22)	227
KRÜSS <i>Epidiascope</i> (Figs. 23-25)	229
MARTIN, P.— <i>Application of Edinger's Drawing and Projection Apparatus to Macroscopic Photography</i>	230
VLÈS, F.— <i>Ocular Micrometer with Interior Vernier</i>	230
WATSON & SONS' <i>Holos Immersion Paraboloid</i> (Fig. 26)	231
SAMUT, R.— <i>Enumeration of Blood-corpuscles</i> (Figs. 27, 28)	231
PULFRICH'S <i>Stereo-Komparator</i> (Figs. 29, 30)	233
BIBLIOGRAPHY	233
GAIDUKOV, N.— <i>Dark-field Illumination and Ultramicroscopy in Biology and in Medicine</i>	367
CLENDINNEN, F. J.— <i>Micrometric Measurements by a Projected Scale</i> (Fig. 48)	368
STRINGER, E. B.— <i>Note on the Use of the Mercury Vapour Lamp in observing the Rings and Brushes in Crystals</i>	440
HANSEN, F. C.— <i>Monochromatic Illumination</i>	514

SIEDENTOPF, H.— <i>Ultra-microscopic Image</i>	515
" " <i>Aplanatic or Cardioid Condenser for Dark-ground Illumination</i> (Figs. 71, 72)	515
TAFNER, H.— <i>Drawing on a Transparent Drawing-surface</i>	517
BROCHER, F.— <i>Drawing with the Camera-lucida</i> (Fig. 90)	651
IGNATOWSKI, W. VON— <i>New Nicol for Projection Purposes</i> (Fig. 91)	652
SIEDENTOPF, H.— <i>Allotropic Conversion of Phosphorus in the Cardioid Ultramicroscope</i>	653
" " <i>Recent Progress in Ultramicroscopy</i> (Fig. 92)	654
SAGNAC, G.— <i>Interferometer, with Inverse Superposed Luminous Rays, giving in White Polarised Light a Narrow Central Fringe of Sensible Tint and Narrow Coloured Fringes at White Intervals</i> (Fig. 93)	654
BIBLIOGRAPHY	655
GEORGI, W.— <i>Measuring Inclination of Abbe's Drawing Apparatus</i>	761
IGNATOWSKI, W. VON— <i>Improvements in the Leitz Mirror Condenser</i> (Pl. XV. and Figs. 107-9)	761
ANDERSON, J. A.— <i>Glass and Metallic Replicas of Gratings</i> (Figs. 110, 111)	763
BARNES, C.— <i>Use of the Grating in Interferometry</i>	764
JONES, R. F.— <i>Dark-ground Illumination with High Power</i>	764
BIBLIOGRAPHY	765

(4) Photomicrography.

PERKINS, R. G.— <i>Cheap non-vibrating Suspension for Microphotography</i>	99
MEES, C. E. KENNETH— <i>Resolving Power of Photographic Plates</i>	99
COMANDON, J.— <i>Ultramicroscopic Cinematography of Living Microbes and of Moving Particles</i> (Plate II.)	100
BIBLIOGRAPHY	100
BANFIELD, A. C.— <i>Method of Preparing Stereo-photomicrographs</i> , Pl. III. (Fig. 31) and Pl. IV. (Fig. 32)	233
REID, DUNCAN J.— <i>Method of Estimating the Exposure in Photomicrography, with Axial Cone Illumination</i>	369
BIBLIOGRAPHY	517
JULIEN, J.— <i>Practical Photomicrography</i> (Fig. 94)	656
NELSON, E. M.— <i>Grayson's Photomicrographs of his Rulings</i> (Plate XIV.)	701
WUNDERER, H.— <i>Printing on Sensitized Papers</i>	765
FRANZ, V.— <i>Photography with Ultra-violet Light</i>	766
BIBLIOGRAPHY	766

(5) Microscopical Optics and Manipulation.

MERLIN, A. A. C. ELIOT— <i>On the Measurement of Grayson's Ten-band Plate</i>	5
BARRETT, W. F.— <i>Methods of Determining the Amount of Light Scattered from Rough Surfaces</i> (Figs. 13-15)	101
BARUS, C.— <i>An Adjustment for the Plane Grating similar to Rowland's Method for the Concave Grating</i> (Fig. 16)	105
TUTTON, A. E. H.— <i>Wave-length Comparator for Standards of Length</i>	107
" " <i>Use of Wave-length Rulings as Defining Lines on Standards of Length</i>	107
BIBLIOGRAPHY	108
MERLIN, A. A. C. ELIOT— <i>On the Measurement of the First Nine Groups of Grayson's Finest Twelve-band Plate</i>	144
NELSON, E. M.— <i>On the Visibility of the Tertiaries of <i>Cocci</i> <i>discus asteromphalus</i> in a Balsam Mount</i>	147
TUTTON, A. E.— <i>Standard Measurement in Wave-lengths of Light</i> (Fig. 33)	235
GRAYSON, HENRY J.— <i>On the Production of Micrometric and Diffraction Rulings</i>	239
DÉCOMBE, M. L.— <i>Measurement of the Refraction Index of Liquids by the Microscope</i> (Fig. 34)	243
MENNELL, F. P.— <i>Pleochroic Halos</i>	243
NELSON, E. M.— <i>Critical Microscopy</i> (Fig. 46)	282
MERLIN, A. A. C. ELIOT— <i>On the Measurement of the Diameter of the Flagella of the Cholera Bacillus prepared by Löffler's Method</i>	290

	PAGE
NELSON, E. M.— <i>What did our Forefathers see in a Microscope?</i> (Fig. 52)	427
RUBENS, H., & H. HOLLNAGEL— <i>Measurements in the Long-waved Spectrum</i>	517
HEEN, P. DE— <i>Phenomena of Light-polarisation in Solid and Pseudo-liquid Organised Matter</i>	518
EWELL, MARSHALL D.— <i>Comparative Micrometric Measurements</i>	537
TRAVIS, C.— <i>Behaviour of Crystals in Light Parallel to an Optic Axis</i> (Figs. 95, 96)	657
VORLÄNDER, D., & H. HANDSWALDT— <i>Axial Images of Fluid Crystals</i>	658
KOSSOGONOFF, J. J.— <i>Ultramicroscopic Examination of Liquids during Electrolysis</i>	658
BIBLIOGRAPHY	659
NELSON, E. M.— <i>A Micrometric Difficulty</i> (Fig. 104)	696
” ” <i>On the Resolution of New Detail in a Coscinodiscus asteromphalus</i> (Fig. 105)	698
GIFFORD, J. W.— <i>Additional Refractive Indices of Quartz, Vitreous Silica, Calcite, and Fluorite</i>	766
FILON, L. N. G.— <i>Measurements of the Absolute Indices of Refraction in Strained Glass</i>	766
SOUTHALL'S <i>Principles and Methods of Geometrical Optics</i>	767

(6) Miscellaneous.

CHAPMAN, F.— <i>On the Microscopical Structure of an Inoceramus Limestone in the Queenstrand Cretaceous Rocks</i> (Plate I.)	1
CRAWLEY, H.— <i>Observations on Mammalian Blood with Dark-field Illumination</i>	108
QUEKETT Microscopical Club	108
ZSCHOKKE, W.— <i>Homogeneity of Optical Glass</i>	244
SPIERS' "Nature through the Microscope"	244
QUEKETT Microscopical Club	245
SCHALLER, W. T.— <i>Refractive Index of Canada Balsam</i>	372
QUEKETT Microscopical Club	518
HERZOG, A.— <i>Diagnosis of Natural and Artificial Silks</i>	659
ANDERSON, J. A.— <i>Method for Testing Screws</i>	767
MYLUIIS, F., & GROSCHUFF— <i>Micro-chemical Tests for Identification of Varieties of Glass</i>	768
SCHNEIDER, J., & J. SOUREK— <i>Ultramicroscopic Examination of Colours of Textile Fibres</i>	770
NELSON, E. M.— <i>Examination in Microscopy</i>	771
QUEKETT Microscopical Club	771
BIBLIOGRAPHY	772

B. Technique.

(1) Collecting Objects, including Culture Processes.

HOFFMAN, C., & B. W. HAMMER— <i>Two New Methods for Growing Azotobacter in Large Quantities for Chemical Analysis</i>	109
LEVADITI, C., & V. STANESCO— <i>Cultivation of Spirochæta gracilis and S. balanitidis</i>	110
ESCH, P.— <i>Cultivating Meningococcus</i>	110
RUSS, C.— <i>Detection of Bacteria by means of an Electric Current</i> (Fig. 17)	110
FEOKTISTOW, A.— <i>New Method for obtaining Pure Cultures from Whole Organs and Pieces of Tissues</i>	111
MARINO, F.— <i>Aerobic Cultures of "Anaerobic" Organisms</i>	111
SCHERESCHIEWSKY, J.— <i>Cultivating Spirochæta pallida</i>	111
HARGITT, G. T.— <i>Collecting Coelenterata, and Observations on the Ova</i>	112
BANKS, N.— <i>Collecting and Preserving Insects</i>	112
FAWCUS, H. B.— <i>Modification of the Conradi Medium for Isolating Bacillus typhosus from Excreta</i>	112
BIBLIOGRAPHY	113
LAVERAN, A., & A. PETIT— <i>Cultivation of Leishmania Donovanii in Fluid Media</i>	245
MAYER, A. G.— <i>Use of Magnesium in Stupefying Marine Animals</i>	246
WIDAKOWICH, V.— <i>Method of Examining Embryos from the Maternal Tissues of the Rat</i>	246
OGATA, M.— <i>Studying New Sporozoon in Rat fever</i>	246

	PAGE
BRUDNY, V.— <i>New Hot-water Funnel</i> (Fig. 35)	246
LEVADITI, C., & V. STANESCO— <i>Examination of the Blood for Trypanosomes, etc.</i>	248
PERKINS, R. G.— <i>Glycerin-agar in Fifty Minutes</i>	248
CHOPPING, F. R.— <i>Solmedia</i>	372
HUXLEY, J. S.— <i>Collecting and Examining Ganymedes anaspidis</i>	373
PORCHER, C., & L. PANISSET— <i>Testing for Indol in Microbic Cultures</i>	373
ALLAN, E. J., & E. W. NELSON— <i>Artificial Culture of Marine Plankton Organisms</i>	374
TEDESCHI, A.— <i>Simple Anaerobic Methods</i>	374
FRUGONI, C.— <i>Cultivation of the Tubercle Bacillus upon Animal Tissues</i>	375
GAEHTGENS, W., & G. BRÜCKNER— <i>Comparative Value of recent Typhoid Culture-media</i>	375
HEIDSIECK— <i>Cultivation of Oidium albicans from Throats</i>	375
LENTZ, O.— <i>New Anaerobic Apparatus</i> (Fig. 73)	520
GALODKOWA, A.— <i>Method of Obtaining Yeast-spores</i>	520
CORANDRA, E.— <i>Differential Diagnosis of Bacillus typhosus and Bacillus coli by means of Coloured Cultivation Media</i>	521
FROUIN, A.— <i>Cultivating Bacillus tuberculosis</i>	521
CLEGG, M. T.— <i>Cultivation of the Leprosy Bacillus</i>	521
DUKE, H. L.— <i>Observations on a New Gregarine, Metamera schubergi g. et sp. n.</i>	659
WENYON, C. M.— <i>Observations on a Flagellate of the Genus Cercomonas</i>	660
CRENDIROPOULO— <i>Simple Anaerobic Method</i>	660
HERON-ALLEN, E., & A. EARLAND— <i>Collecting Living Foraminifera</i>	661
GESSARD, C.— <i>New Method of Preparing Culture Media</i>	663
CRENDIROPOULO, M., & A. PANAYOTATOU— <i>Isolation of Cholera Vibrios</i>	663
BIBLIOGRAPHY	663
HJOET, JOHAN— <i>Michael Sars' North Atlantic Deep-sea Expedition, 1910</i>	772
GAMBLE, F. W.— <i>Studying the Relation between Light and Pigment-formation in Crenilabrus and Hippolyte</i>	773
SAUNDERS, A. M. C., & MARGARET POOLE— <i>Studying the Development of Aplysia punctata</i>	774
BRUYNOCHE, R.— <i>Cultivation of Meningococci</i>	774

(2) Preparing Objects.

KOLMER, W.— <i>Studying the Labyrinth</i>	113
HELD, H.— <i>Studying the Finer Structure of the Labyrinth of Vertebrata</i>	113
PRICE-JONES, C.— <i>Studying Development of Red Blood Cells in the Chick</i>	114
BOEKE, J.— <i>Demonstrating Motor End-plates</i>	114
MAXIMOW, A.— <i>Researches on Blood and Connective-tissue</i>	114
HASWELL, W. A.— <i>Hardening and Imbedding the Eggs of Temnocephala fasciata</i>	114
SUZUKI, B.— <i>Improved Method of Dehydration</i> (Fig. 36)	249
RAWITZ, B.— <i>New Methods of Investigating the Central Nervous Systems of Vertebrates</i>	249
KOWLER, R.— <i>Washing Apparatus for Fixed Material</i> (Figs. 37, 38)	250
KITTSTEINER, C.— <i>Methylated Spirits for Histological Purposes</i>	250
MAXIMOW, A.— <i>Preparing Delicate Embryonic Tissues for Histological Examination</i>	251
PALSCHIEWSKA, IRENE VON, & MARIE WERNER— <i>Examining the Structure of Human Heart-muscle</i>	252
UHLENUTH, P., & OTHERS— <i>New Methods for Examining Sputum</i>	252
BIBLIOGRAPHY	253
MEUNIER, L., & C. VANEY— <i>New Method of Fixing Plankton</i>	375
PÉREZ, C.— <i>Studying Metamorphosis of Muscidae</i>	376
KOWALSKI, J.— <i>Studying the Neurofibrils in Lumbricus</i>	376
BONNET, A.— <i>Fixation of Algæ by means of Quinone</i>	521
FLATTERS & GARNETT— <i>Dissecting Tile and Stand</i> (Fig. 74)	522
SOMMERFELD, P.— <i>Modification of Neisser's Staining for Diphtheria Bacilli</i>	522
KENT, A. F. S.— <i>New Method of Staining Spores</i>	522
GIEMSA, G.— <i>Staining Moist Preparations and Sections by the Azur-eosin Method</i>	522
ARNOLD, W.— <i>New Colour Reaction for certain Albumins</i>	522
PORTER, ANNIE— <i>Studying Structure and Life-history of Crithidia melophagia</i>	664
CILIMBARIS, P. A.— <i>Demonstrating Muscle-spindles</i>	664
ARNDT, G.— <i>Automatic Fixing and Imbedding Apparatus</i> (Figs. 112-14)	774
FIEANDT, H. VON— <i>Preparation and Staining of Neuroglia</i>	776

(3) Cutting, including Imbedding and Microtomes.		PAGE
MACBRIDE, E. W.— <i>Studying the Development of Amphioxus</i>		115
MULLENIX, R. C.— <i>Demonstrating Peripheral Nerve Terminations</i>		115
TIMOFEJEV, D.— <i>New Method of Staining the Connective-tissue Framework of Viscera</i>		116
BERLINER, K.— <i>Cutting Thin Parallel Slices of Brain Substance (Fig. 39)</i>		253
LENDVAI, J.— <i>Apparatus for Whetting a Microtome Knife (Figs. 40-44)</i>		253
LEBRUN, H.— <i>Rotatory Method in Microscopy</i>		255
BERG, W.— <i>Simple Method of Paraffin Imbedding in Vacuo</i>		255
DAKIN, W. J.— <i>Studying Eye of Pecten</i>		376
BERLINER, K.— <i>Improved Brain Microtome (Fig. 49)</i>		377
ANDIGÉ, J.— <i>Injecting Kidney of Teleostean Fish</i>		378
NAGEOTTE, Y.— <i>Method of Preparing Frozen Sections of Brain-substance</i>		378
BONVICINI, G.— <i>Microscopical Sections through both Cerebral Hemispheres (Fig. 50)</i>		379
CARAZZI, D.— <i>Cooling of Paraffin Blocks</i>		380
FLATTERS & GARNETT'S "Firmax" Microtome (Fig. 97)		665
BOEKE, J.— <i>Van der Stad's Improved Rocking-microtome (Figs. 98-103)</i>		665
FUNCK, C.— <i>Theory and Practice of Sharpening Razors</i>		777
CAMBRIDGE SCIENTIFIC INSTRUMENT CO.— <i>Large Sliding Microtome (Pl. XV.</i>		
(Figs. 2, 3)		778
EIGHTEENTH CENTURY Microtome (Fig. 115)		779
YURISCH, A.— <i>Numbering Celloidin Sections</i>		782
BIBLIOGRAPHY		782

(4) Staining and Injecting.

BETEGH, L. VON— <i>New Method of Demonstrating the Spores in Acid-fast Bacteria</i>		116
FUHRMANN, F.— <i>Methods of Demonstrating the Flagella and Minute Structure of</i>		
<i>Spirillum volutans</i>		116
GASSI, D.— <i>New Staining Reaction for Tubercle Bacilli</i>		117
CIACCIO, C.— <i>Demonstrating the Presence of Lipoids in Cells</i>		117
STEPHAN, S.— <i>Modification of Gram's Method of Staining</i>		118
MARTINOTI, L.— <i>Staining Foszophilous Cells</i>		118
MARUYAMA, T.— <i>Method of Staining Peripheral Nerves</i>		256
SARAGNONE, E.— <i>Fluoride of Silver in Golgi's Method</i>		256
VANDENDRIES, R.— <i>Studying the Development of Crucifera</i>		256
FUNCK, C.— <i>Device for Polishing Mounted Sections during Dehydration (Fig. 45)</i> ..		257
MOZEJKO, B.— <i>Injection Methods applied to certain Mollusca</i>		257
BERGEN, KARL— <i>Different Methods of Staining Tubercle Bacilli</i>		258
HEINRICH, G.— <i>Studying the Development of Dentine in Mammalia</i>		258
WESCHÉ, W.— <i>Quick Method of Preparing and Staining Pollen</i>		380
CARAZZI, D.— <i>Bleaching Methods</i>		380
GUEBERT, M., & OTHERS— <i>Chemical Basis of Gram's Method of Staining</i>		381
EISENBERG, P.— <i>Nile-blue Staining for the Demonstration of Metachromatic Granules</i>		381
MAYER, P.— <i>Methods of Staining Glycogen</i>		381
MOZEJKO, B.— <i>Further Note upon Injection Methods</i>		382
ABEL, WILLIAMINA— <i>Staining Embryonic Nerve-tissues</i>		382
FRIEDSOHN, F.— <i>Studying the Morphology of the Blood of Amphibia</i>		383
NEMILOFF, A.— <i>Studying the Varicosities on Non-medullated Nerve-fibres</i>		383
LAUNOY, L.— <i>Cell Inclusions in Rabbit's Liver</i>		383
POLIGARD, A.— <i>Vital Staining of Trypanosomes</i>		384
LEGENDRÉ, R.— <i>Golgi's Method for Examining the Internal Network of Spinal</i>		
<i>Marrow Cells</i>		384
MCJUNKIN, F. A.— <i>Staining Sections by the Romanowsky Method</i>		370
SNESAREW, P.— <i>Modification of Bielschowsky Silver Method</i>		677
LEVY— <i>Diagnostic Value of the Staining Method of Gasis</i>		60
SAMSSONOW, N.— <i>Identity of Flemming's and Altmann's Granules</i>		671
PHILIP, R. W., & AGNES E. PORTER— <i>Detection of Tubercle bacilli in Fæces</i>		671
HINDLE, E.— <i>Staining Trypanosoma dimorphon</i>		672
DODSON, E.— <i>Method of Staining Deep Colonies in Plate Cultures</i>		672
LIPPMANN, A.— <i>Demonstrating Tubercle Bacilli in the Blood</i>		673
HARRIES, E. H. R.— <i>Detection of Tubercle Bacilli in Milk and Fæces</i>		782
WRIGHT, J. HOMER— <i>Staining Blood Platelets</i>		783

	PAGE
GIEMSA, G.— <i>Staining Wet Films by Giemsa's Azur-eosin Method</i>	784
HAYHURST— <i>Staining Blood Smears</i>	785
NOVAK, J., & F. RANZEL— <i>Detection of Tubercle Bacilli in the Placenta</i>	785
GALLI-VALERIO, B.— <i>Indian-ink Method in Parasitology</i>	785
MICHIALOW, S.— <i>Staining Nervous Tissues with Methylene-blue</i>	785
SCHLENMER, A.— <i>Preparation of Ammoniacal Silver Solution</i>	786
MARTINOTTI, L.— <i>Toluidin-blue</i>	786
" " <i>Hæmatin Stains</i>	786
CAVAZZA, L. E.— <i>Chemistry of Vegetable Pigments</i>	786
BALLENGER— <i>New Dahlia Stain</i>	786
KILDUFFE— <i>Stable Solution of Gentian-violet</i>	787
LINDNER, K.— <i>Staining Prowazek's Bodies</i>	787

(5) Mounting, including Slides, Preservative Fluids, etc.

CARAZZI, D.— <i>Fixation of Celloidin Sections</i>	384
SMITH, F. P.— <i>Mounting Spider Dissections as Microscopical Objects</i>	385
MAYER, P.— <i>Turpeneol for Microscopic Purposes</i>	523
BANKS, C. S.— <i>Polyscopic Cell</i>	673
ANITSCHOW, N.— <i>Mounting Serial Celloidin Sections</i>	787
" " <i>Mounting Frozen Sections</i>	787

(6) Miscellaneous.

GEMMILL, J. F.— <i>An Automatic Aerating Apparatus, suitable for Aquaria, etc.</i> (Fig. 1)	9
GINS, A. A.— <i>Burri's India-ink Method</i>	118
LEVY, O., & OTHERS— <i>Experimental Study of Development during the past decade</i> ..	258
CARRUTHERS, V. T.— <i>Simple Method of Counting Leucocytes</i>	259
HALLE, B.— <i>Method of Estimating the Hardness of Minerals</i>	259
COLLINS, F. H.— <i>On the Labelling of Microscope Slides</i>	267
RUEDIGER, E. H.— <i>Filtration of Immune Sera</i>	385
FRÜHWALD— <i>Indian-ink Method of Demonstrating Spirochæta pallida</i>	386
CHOPPING, F. R.— <i>New Drop Bottle</i> (Fig. 51)	386
MOŽEJKO, B.— <i>Preparation of Osteological Specimens</i>	523
" " <i>Formalin for the Preparation of Museum Specimens</i>	523
FLATERS & GARNETT— <i>Glycerin Jelly Bath</i> (Fig. 75)	524
" " <i>Microscope Slide Cabinets</i> (Figs. 76, 77)	524
SCHMIDT, F. W.— <i>Removing Over-hardening in Anatomical and Histological Pre- parations, and New Method of Silver Impregnation</i>	674
PENSA, A.— <i>Gelatin Plates for Graphic Reconstruction</i>	787
KRONIG, G.— <i>Morphological Demonstration of Methæmoglobin in Blood</i>	788
BIBLIOGRAPHY	788

Metallography, etc.

GIOLOTTI, F., & G. TAVANTI— <i>Copper-tin Alloys</i>	119
PANNAIN, E.— <i>Silver Coinage Alloys</i>	119
ANDREW, J. H., & C. A. EDWARDS— <i>Aluminium-copper-tin System</i>	119
DUNSTAN, A. E.— <i>Lead and Tin Alloys</i>	119
GRARD— <i>Brass and Copper</i>	119
BURGESS, C. F., & J. ASTON— <i>Iron Alloys</i>	120
" " <i>Iron-manganese Alloys</i>	120
" " <i>Iron-copper Alloys</i>	120
RÉVILLON, L.— <i>Steels for Gears</i>	120
GIESEN, W.— <i>Special Steels</i>	120
PORTEVIN, A. M.— <i>Special Ternary Steels</i>	121
WÜST, F., & P. GOERRENS— <i>Iron-carbon Diagram</i>	121
GUILLET, L., & C. GRIFFITH— <i>Cementation by Carbon</i>	122
CHATELIER, H. LE, & OTHERS— <i>Constituents of Steel</i>	122
HOWE, H. M.— <i>Metallography of Iron</i>	122

	PAGE
GRENET— <i>Transformations of Iron and Steel</i>	123
„ <i>Hardness of Steel</i>	123
GOLITTL, F.— <i>Use of Metallic Deposits in Metallography</i>	123
BENGOUGH, G. D.— <i>Rate of Change in Alloys</i>	123
BELLEY, G. T.— <i>Surface-flow in Calcite</i>	123
WALKER, W. H.— <i>Testing of Galvanised Metals</i>	124
SHUKOFF, I. I.— <i>Magnetic Transformation of Nickel and Cobalt</i>	124
CHATELIER, H. LE.— <i>Testing by Alternating Stress</i>	124
BAKER, T.— <i>Gases Occluded in Steel</i>	124
BIBLIOGRAPHY	124
STAHL, W.— <i>Microstructure of Copper</i>	260
PANNAIN, E.— <i>Physical Properties of Alloys</i>	260
CURRY, B. E.— <i>Some Zinc Alloys</i>	260
PUSHIN, N. A., & M. S. MAXIMENKO— <i>Alloys of Silver with Zinc</i>	260
GUERTLER, W.— <i>Alloys of Tin and Lead</i>	260
KURNAKOW, N. S., & S. ZEMCZUZYNY— <i>Alloys of Lead with Indium and Thallium</i>	261
URASOW, G. G.— <i>Aurides of Magnesium</i>	261
ZEMCZUZYNY, S., & J. SCHUEPELEW— <i>Phosphorus Compounds of Cobalt</i>	261
BILTZ, W., & W. MECKLENBURG— <i>Systems: Tin-sulphur, Tin-selenium, Tin-tellurium</i>	261
BORNEMANN, K., & F. SCHREYER— <i>The System Cu₂S-FeS</i>	261
PELLINI, G.— <i>Mixed Crystals of Sulphur and Tellurium</i>	262
BURGESS, C. F., & J. ASTON— <i>Influence of Arsenic and Tin upon Iron</i>	262
CHATELIER, H. LE, & S. WOLOGDINE— <i>Phosphides of Iron</i>	262
OBERHOFFER, P.— <i>Alloys of Iron</i>	262
CAMPBELL, W.— <i>Heat-treatment of Iron and Steel</i>	262
FAY, H., & OTHERS— <i>Defects in Steel Rails</i>	263
HOWARD, J. E.— <i>Tests of Ingots</i>	263
HOWE, H. M.— <i>Closing of Blowholes in Steel Ingots</i>	263
COOK, F. J., & G. HAILSTONE— <i>Structure of Cast Iron</i>	263
TAMMANN, G.— <i>Magnetic Properties of Alloys of Ferro-magnetic Metals</i>	264
WEDEKIND, E.— <i>Magnetic Character of Compounds of Non-magnetic Elements</i>	264
OBERHOFFER, P.— <i>Metallographic Observations at High Temperatures</i>	264
WHITE, W. P.— <i>Determination of Melting-points</i>	264
DAY, A. L., & R. B. SOSMAN— <i>Nitrogen Thermometer</i>	265
BIBLIOGRAPHY	265
CHAPMAN, J. C. H., & L. PORTER— <i>Properties of Gold Leaf at High Temperatures</i>	387
WANJUKOFF, W.— <i>Microstructure of Copper</i>	387
BARRÉ, M., & W. BRONIEWSKI— <i>Copper-aluminium Alloys</i>	387
VIGOUROUX, E.— <i>Alloys of Nickel and Copper</i>	387
DUGELLIEZ, F.— <i>Alloys of Cobalt</i>	388
JOLIBOIS, P.— <i>Phosphides of Tin</i>	388
„ <i>Phosphides of Nickel</i>	388
TAMMANN, G.— <i>Effect of Compressing Mixtures of Metals</i>	388
WÜST, F.— <i>Shrinkage of Metals and Alloys</i>	388
COHEN, E., & K. INOUE— <i>Metastability of Metals</i>	389
ROSENHAIN, W., & J. C. W. HUMFREY— <i>Crystalline Structure of Iron at High Temperatures</i>	389
RUGAN, H. F., & H. C. H. CARPENTER— <i>The "Growth" of Cast Irons after repeated Heatings</i>	390
GUTOWSKY, N.— <i>Iron-carbon Alloys</i>	390
PORTEVIN, A., & H. BERJOT— <i>Hardness of Quenched Steels</i>	391
GRENET, L.— <i>Cementation of Silicon Steels</i>	391
SWINDEN, T.— <i>Carbon-tungsten Steels</i>	391
BURGESS, C. F., & J. ASTON— <i>Magnetic Properties of Alloys of Iron</i>	391
ZSCHOKKE, B.— <i>Effect upon Steel of Sudden Changes of Temperature</i>	391
OBERHOFFER, P.— <i>Importance of Metallography in the Iron Industry</i>	392
CHARPY, G., & S. BONNEROT— <i>Cementation by Solid Carbon</i>	392
MAZZOTTO, D.— <i>Composition of Mixed Crystals in Alloys</i>	392
STOCK, A.— <i>Sintering-point Curve</i>	392
WAHL, W.— <i>Cobalt-gold Alloys</i>	525
GUERTLER, W.— <i>Lead-tin Alloys</i>	525

	PAGE
KNIGHT, S. S.— <i>Apparatus for Metallographic Work</i>	792
ARNOU, G.— <i>Metallography in German and Belgian Laboratories</i>	792
CLOUP, F.— <i>Testing Steel by Corrosion</i>	793
SCHIMPF, F.— <i>Heat-capacity of Metals and Compounds</i>	793
LICHTENECKER, K.— <i>Resistance of Alloys free from Solid Solutions</i>	793
GISSING, C. E.— <i>Spark Spectra of the Metals</i>	793
SHEPHERD— <i>National Physical Laboratory</i>	794
SMITH, C. A. M.— <i>Properties of Non-ferrous Metals</i>	794
RUZICKA, ST.— <i>Mixed Crystals or Solid Solutions?</i>	794
MATWIEFF— <i>Metallographical Study of Slags</i>	794
BIBLIOGRAPHY	795

PROCEEDINGS OF THE SOCIETY.

Meeting, December 15, 1909	125
„ January 19, 1910	129
„ February 16, „	266
„ March 16, „	269
„ April 20, „	393
„ May 18, „	397
„ May 25, „	399
„ June 15, „	532
„ October 19, „	796
„ November 16, „	799

GENERAL INDEX TO VOLUME	809
---------------------------------	-----



FIG. 1.

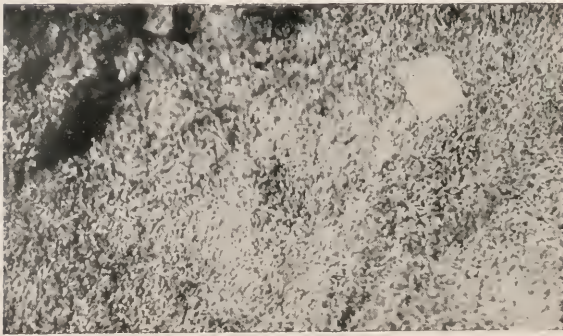

FIG. 2.



F. C. Phot.

FIG. 3.

INOCERAMUS ROCK. L. CRETACEOUS: QUEENSLAND.

JOURNAL
OF THE
ROYAL MICROSCOPICAL SOCIETY.

FEBRUARY, 1910.

TRANSACTIONS OF THE SOCIETY.

I.—*On the Microscopical Structure of an Inoceramus Limestone
in the Queensland Cretaceous Rocks.*

By FREDERICK CHAPMAN, A.L.S., F.R.M.S.

(Read November 17, 1909.)

PLATE I.

Prefatory.—The occurrence of a rock largely composed of the remains of *Inoceramus* shells in the Lower Cretaceous of Queensland is by no means new. The interest attaching to it, however, especially from a petrological point of view, will justify a fuller description than has yet been given.

In Messrs. Jack and Etheridge's valuable and comprehensive work on "The Geology and Palæontology of Queensland and New Guinea,"* Mr. Jack makes the following observations (p. 400):—"Eight miles beyond the Williams [River] are blocks of a very hard brecciated siliceo-calcareous stratified rock, from which I obtained *Inoceramus*. Portions of the rock were almost entirely made up of the disintegrated shelly fibres of this genus." Further, the same author remarks (p. 401):—"Fifteen miles from the Williams (on

* Brisbane and London, 1892.

EXPLANATION OF PLATE I.

- Fig. 1.—*Inoceramus* limestone, viewed at right angles to the bedding plane; showing current bedding. About natural size.
,, 2.—Surface of bed-plane, showing fragments of *Inoceramus* shell and numerous shell-prisms. About natural size.
,, 3.—Section parallel with bed-plane, showing constitution of the *Inoceramus* limestone, shell-prisms and angular quartz-grains imbedded in a calcareo-ferruginous matrix. $\times 18$.

Feb. 16th, 1910

13

Fisher's Creek waters), sandstones composed almost entirely of the fibrous shelly matter of *Inoceramus* are seen to rest on hardened black slates and Lydian stone. Indeed, in several places, notably near Marathon, I noted the presence of beds almost entirely composed of this fibrous material, sufficient to attest that this mollusc must have lived in almost incredible numbers."

In the same work, p. 463, Mr. R. Etheridge, jun., in referring to the second of the occurrences noted by Mr. Jack, says:—"Specimens of an argillaceous limestone have been obtained, with the weathered surfaces covered with white spicular or needle-shaped bodies, which are nothing more than the broken-up prisms of the shell-structure of *Inoceramus*." These quotations will serve to show the relatively great abundance of *Inoceramus* in the North Queensland Cretaceous series.

The hand specimens of *Inoceramus* limestone which form the subject of the following notes, came from the Lower Cretaceous beds 63 miles north of Longreach, Queensland: a locality more than 250 miles to the south of those mentioned by Messrs. Jack and Etheridge. These rock specimens were presented to the National Museum, Melbourne, by Mr. John Williams.

Megascopic Structure.—The rock is of a pink to pale chocolate-brown colour, weathering to ochreous yellow. On fractured surfaces it appears of a deep reddish brown. The exposed surfaces are densely covered with the spiculiform prisms of the thick outer layer of *Inoceramus* shells; and these form so important an ingredient of the limestone as to whiten the weathered surface. Mr. R. H. Walcott, F.G.S., of the National Museum, has kindly examined the rock in regard to the proportion of carbonate of lime in it—largely due to the presence of these shell-prisms—and he finds this to amount to as much as 60 p.c. This proportion to the bulk of the rock approaches that in a sample of Totternhoe stone, in the Grey or Lower Chalk of England, in which Mr. Wm. Hill* found the prisms of *Inoceramus* shell to constitute at least 60 to 70 p.c. of the mass. The presence of these prisms in the Queensland rock is, however, rendered more striking than in the English Grey Chalk by the dark colour of the matrix. On the edge of a vertical fracture, or joint-plane passing through the plane of bedding, the shell-prisms are seen to be disposed generally with their longer axes parallel with the bedding plane. These lines of sedimentation are so distinctly marked by the prisms as to demonstrate very beautifully the false bedding which is typical of this rock. Here and there on the weathered surface fragments of *Inoceramus* shells may also be seen conspicuously standing out in quadrangular outline, measuring from about 3–7 mm. on the side: these measure-

* See Cretaceous Rocks of Britain, ii. Lower and Middle Chalk of England. Jukes-Browne and Hill, 1903, p. 300.

ments being the limiting thicknesses of the shells noticed. Subjected to the influence of weathering, the rock shows a tendency to exfoliate in large pieces, the surfaces of which are not always in perfect parallelism with the sedimentary planes, but often highly curved.

Microscopic Details.—In thin sections under the Microscope the *Inoceramus* prisms are seen to occupy a large part of the field. They show a rudely parallel arrangement, and are cemented together by a ferruginous and calcareous matrix. As before stated, they measure from about 3–7 mm. in length. The carbonate of lime in the matrix approximates to about 10 p.c. of the whole, so that it reduces the proportion of shell-material to about 50 p.c. of the rock-mass. Interspersed amongst the shell-prisms are numerous perfectly angular fragments of clear quartz, and an occasional piece of felspar (pagioclase). The quartz grains sometimes contain needles of rutile. The *Inoceramus* prisms vary from clear calcite to pale brown granulated calcite. In nearly all may be seen the accretionary bands of growth of the original shell-structure, at right angles to the length of the prismatic axis. They are horn-brown in colour and of varying translucence. Numerous differential cracks break up the prisms at right angles to their length into quadrate sections, but the original rhombohedral cleavage is always more or less distinct. Between crossed nicols most of the prisms behave as single crystals of calcite, and show a straight extinction. The boundaries of the prisms are in all cases sharply outlined in dark brown, owing to a surface deposit of ferruginous material. Sometimes there is a thin superficial outgrowth of calcareous crystals upon the prisms, and, more rarely, corrosion of the surface of the prism has taken place. Here and there the prisms show a finely granulate appearance, their internal structure having been physically reconstructed. In some cases there is evidence of slight dolomitisation.

Conditions of Deposition.—As a general conclusion the Queensland Lower Cretaceous rocks may be said to have been deposited in fairly shallow water, as seen particularly by the current-bedded structure; the *Inoceramus* shells in all probability having formed part of the beach-material of that ancient shore-line.

The Lower Cretaceous rocks in the northern part of Queensland rest upon gneisses and granites; the jurassic series (Ipswich formation) being wanting. At a distance of about 150 miles to the north of the locality which furnished the limestone in question, there is a massif of granite with a limited area of gneiss at the foot. Against these granitic rocks the shore deposits of the Lower Cretaceous sea were undoubtedly laid down. The angular quartz grains and occasional felspars previously referred to, as forming a large proportion of the *Inoceramus* limestone, would therefore most likely be derived directly from the detritus of the highlands in the vicinity, and

thus the angular character of the detrital grains of those minerals would be explained.

What may be regarded as additional evidence proving the shallow-water origin of these Cretaceous limestones and sandstones, is shown by the occurrence of some drift-wood found in the same beds and partly coated with *Inoceramus*-bearing mud and sand. A specimen of this wood, given to the Museum collection by Mr. Williams, was seen to be much corroded and bored by some organism. A microscopical examination of a thin section of the wood showed the presence of pitted cells, but as these are typical of both Conifers and Cycads, it is impossible to say to which group of plants it belongs. The Conifers, however, being more abundant in Lower Cretaceous times, the probability weighs in favour of the latter type of vegetation. Instances are not unknown where fossil drift-wood has occurred in sediments of moderately deep-water origin, as in the occurrence of coniferous wood in the English Chalk at Croydon found by Murton Holmes.* Under ordinary circumstances it is, however, more usual to find fossil drift-wood associated with littoral deposits, as for example, in the shallow deposits of the Gault at Folkestone, and in the Lower Greensand of the Isle of Wight. It is easily conceived that a piece of floating wood soon becomes the object of attack from various marine parasites and boring animals, which render it just heavy enough to sink and to become inclosed in the mud of the sea-bed. On account of its comparatively low specific gravity it stands a good chance of being again cast ashore and commingled with the sand and shells of the sea-shore.

* See Fossil Plants, by A. C. Seward, 1898, pp. 61-2, fig. 8.

II.—*On the Measurement of Grayson's Ten-band Plate.*

BY A. A. C. ELIOT MERLIN.

(Read December 15, 1909.)

SOME years ago I undertook the laborious work of carefully measuring all the spacings of my Grayson's ten-band stage micrometer. As such a task has probably not been undertaken by many, I venture to communicate the results obtained in case they may prove of interest to some Fellows of the Society.

Two conditions appear to me of paramount importance in all delicate micrometrical work where the most accurate results are aimed at:—

1. An objective of comparatively very high initial magnifying power should be employed.

2. The micrometer eye-piece should be of moderate power, so as not to unduly magnify errors which must always exist in even the best screws.

Under such circumstances, care being taken that the same portion of the screw is utilised so far as possible, highly accurate measurements may be effected.

For spanning the rulings of the Grayson plate it was decided to employ a nominal $\frac{1}{16}$ Powell dry objective. This lens is really 0.054 in. focus, has an initial magnifying power of a fraction over 185 on 10-in. tube, and its N.A. is 0.906. The optical index is thus extremely low (4.9), but, nevertheless, used under strictly critical conditions in conjunction with the 6 eye-piece of Powell's micrometer, the ruled lines appeared sharp, it being therefore possible to adjust the "wires" very precisely against the diffraction edges of the rulings. Although the optical arrangement, specified above, was selected at the time as the most suitable then available for the purpose in view, it is by no means maintained that the combination in question is the best possible, or the most desirable, and since that time I usually employ an amplifier, kindly specially computed by Mr. E. M. Nelson,* used in conjunction with a Powell $\frac{1}{12}$ oil-immersion objective of N.A. 1.27, and thus augmenting its initial magnifying power about 2.5 times. In order to obtain clear definition with the amplifier inserted between the objective and ocular, it is necessary that the former be provided with a correction collar, by means of which the

* See this Journal, 1904, p. 396.

disturbance caused by the intervening negative lens can be compensated. With the $\frac{1}{12}$ objective, amplifier and 6-micrometer eye-piece, 1318 divisions of the drum equal $\frac{1}{1090}$ in.; thus the movement of the "wire" through one drum division represents an interval amounting to $\frac{1}{1318} \frac{1}{8000}$ in. This may seem a practically unattainable degree of accuracy, but it must be borne in mind that separating power is not here in question, and, to myself at least, the wonderfully close agreement of the means of the first five columns of measurements annexed hereto are sufficiently significant, considering that they were effected with an objective, the utmost separating limit of which could not exceed $\frac{1}{94000}$ in.

With reference to the annexed results, taking 763·4, the mean of the first band, as a standard (the mean of nine out of ten divisions of another equally spaced Grayson plate in my possession is 763·6, the first space of the band being rejected as obviously faulty, it measuring only 752·5 divisions), we find that the second column, expressed in similar parts of an inch, varies from it by just under one drum division, or $\frac{1}{763400}$ in., the means of the second and third columns agreeing within the surprising amount of $\frac{1}{10}$ of a division, or $\frac{1}{7633000}$ in.! The mean of column four exceeds the standard by three divisions, while column five shows an excess of nearly two. It will be noticed that fairly considerable differences exist in the spacing of the individual lines in all the bands, but I venture to submit that the accuracy of the measurements is proved by the remarkably close agreement of the means of the various columns, expressed, for convenience of comparison, in similar and equal terms. So far as I can judge, the theory of probabilities renders it practically certain that such a close agreement of five means can be due to no fortuitous coincidence.

The sixth column exhibits the greatest variation from the standard, falling short by the very considerable amount of 16·3 divisions, representing a difference of about $\frac{1}{46834}$ in. The seventh column falls short of the standard by 7·7 divisions, and the eighth by 9·8. Columns nine and ten show that the two finest bands are wonderfully evenly ruled, their means being, respectively, 4·8 and 8·4 divisions more than the standard.

Since writing the foregoing, it has been thought desirable that measured readings of two lines together throughout the second band, three lines together throughout the third band, four through the fourth, and so on up to ten through the tenth, should be effected with the exact optical arrangement and magnification employed for the original measurements. In this manner the value of the whole ten bands is indicated in terms of the first, and exactly the same portion of the screw is utilised for all, thus error from differences in varying parts of the screw is eliminated, and consequently the means of the five necessary readings in each of

the last nine bands will show the extent of that factor in the original measures.

This idea has been carried out, with the following results, which indicate the high accuracy of Mr. Grayson's rulings. The mean of the first band re-measured equals 762·9 divisions.

			Drum Divisions
2nd band	$(\frac{1}{20000}$ in.).	Mean of five $\frac{1}{10000}$ in. readings	763·1
3rd "	$(\frac{1}{30000}$ in.).	762·4
4th "	$(\frac{1}{40000}$ in.).	764·1
5th "	$(\frac{1}{50000}$ in.).	758·8
6th "	$(\frac{1}{60000}$ in.).	760·6
7th "	$(\frac{1}{70000}$ in.).	758·4
8th "	$(\frac{1}{80000}$ in.).	758·6
9th "	$(\frac{1}{90000}$ in.).	758·9
10th "	$(\frac{1}{100000}$ in.).	758·6

It will be noted that screw errors are thus revealed and differentiated. Another remarkable circumstance is the startling agreement of the last four means, an exactness which perhaps suggests some little coincidence, especially as the fractional division readings, from which the means are obtained, are necessarily only estimated tenth parts. Be this as it may, it is obvious that the probable error is exceedingly small.

III.—*An Automatic Aerating Apparatus, suitable for Aquaria, etc.*

By JAMES F. GEMMILL, M.A. M.D.

(Read December 15, 1909.)

THE Aerator (fig. 1) to be described costs little and is reliable, besides having other advantages which are referred to later. The essential features of the apparatus are: (1) a constant inflow of water into a closed vessel forces the contained air under pressure through the aerating nozzles; (2) the vessel is emptied automatically at regular intervals by siphon action, air being allowed to replace the water siphoned off. During this period, which is relatively short, there is a pause in the output of air.

Explanation of the lettering on the Sketch.

A. Constant inflow of water under 8 feet or more of water pressure. The inflow must be sufficient to insure the advent, at the proper time, of siphon action. If too scanty the water will simply trickle over the summit of the siphon tube. But the inflow should not be so great as to compete effectively with the emptying action of the siphon. In practice the proper rate can be got in a few minutes by manipulating the water-tap, but most water-taps require readjustment for the first few days.

B. A small vessel (the water valve vessel) suspended within the large vessel C. B is kept full by the inflow and it overflows into C. The end of the tube F just dips into the water within B.

C. A large glass bottle (e.g. of $\frac{3}{4}$ gallon size) with moderately wide mouth closed by a rubber bung with perforations for the tubes A, D, E and F. The bung must be quite air-tight, and it should be fixed securely in the neck of the bottle so that it may not be driven out when the pressure rises within the bottle. The constant inflow of water tends to fill the bottle, driving the contained air up the aerating tube D. Sooner or later the bottle C is emptied by the siphon E, and then the filling up process starts anew.

D. Aerating tube of $\frac{7}{16}$ in. internal measurement. The lower end just pierces the rubber bung and is bevelled, while the upper end reaches above the summit of the siphon. From the upper end a small indiarubber tube (K in the sketch) leads to the aerating nozzles, the number of which may be multiplied indefinitely by

means of Y tubes or other simple device. The height of D is greater than that of the siphon in order to insure that under no circumstances will water find its way into the rubber tubing. The width of D and the bevelling of its lower end insure that any

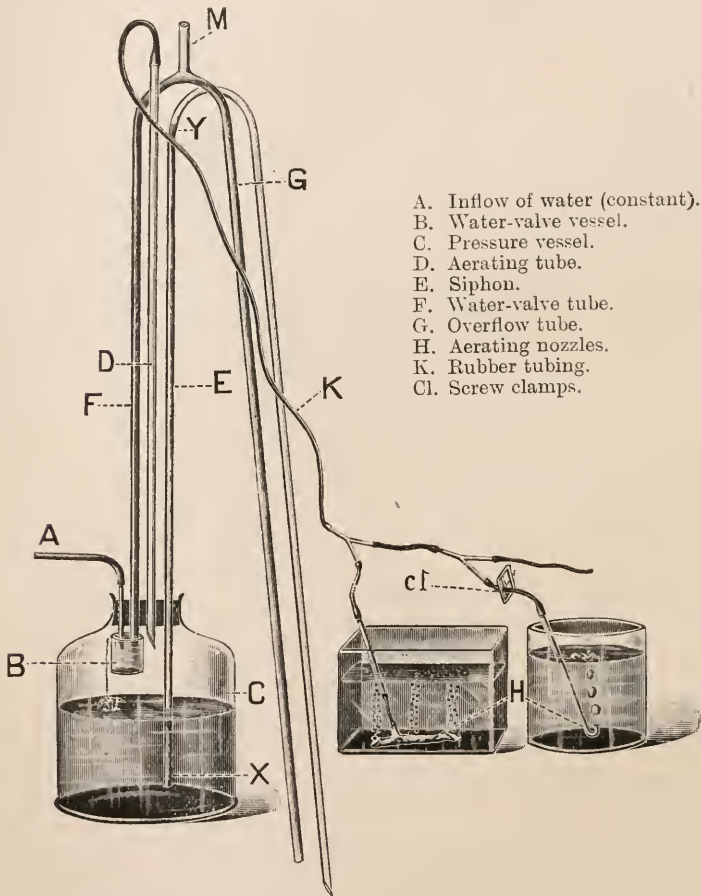

FIG. 1.

water which may have got into it will readily fall back into the vessel C when this vessel is being emptied by the siphon.

E. Siphon. One end passes through the bung almost to the bottom of the vessel C, while the other end goes to an outlet and reaches not less than $1\frac{1}{2}$ to 2 ft. below the level of the first. The

siphon, as well as the tubes F and G, is of ordinary glass, $\frac{3}{8}$ in. internal measurement. A good all-round working height is 7 or $7\frac{1}{2}$ ft. from X to Y. This gives pressure enough to aerate with finely divided air bubbles, but the higher the siphon the better will be the pressure and the finer the streams of bubbles that can be produced. On the other hand, a total height of about $2\frac{1}{2}$ ft. is all that is required for the output of ordinary bubbles and for their distribution over different aquaria the depth of which does not exceed a foot or so. (See also commencement of paragraph under G.)

F. Water valve tube. This is open above at M, and passes into an overflow tube G, the bend being an inch or two above the top of the siphon. The primary purpose of the tube F is to allow the periodic entrance of air into C during the time when the emptying of this chamber by the siphon takes place. Any water which may be in F flows back into C and is followed by air, which bubbles up freely from the lower end of this tube. On the other hand, air is not allowed to escape by F when C is filling up again and the aerating nozzles are working under full pressure. What happens is, that water rises in F, as it does also in the ascending limb of the siphon. The height of the water in the former exceeds that in the latter by exactly the difference of the water levels in B and C. The rise is rapid till overflow from F into G occurs. This does not set up siphon action, because air enters freely at M. But as C fills up, the water level in the siphon creeps higher and higher till its summit is overpassed and siphoning begins. Pressure inside C then becomes negative; the water in F flows back into C, and is followed by air entering at M.

G. Overflow tube, described above. This is hardly required for an apparatus designed only for ordinary bubbles under low pressure. See end of paragraph under E. (Although it is not shown in the sketch, I have lately been using the surplus water which overflows by G, in my apparatus at Glasgow University, to provide a supply of air under low pressure. This is done on the principle of the Sprengel pump, with the help of the Naples Station device, viz. a circular bend in the upper part of the tube.)

H. Aerating nozzles. For ordinary bubbles a bit of glass tubing, slightly turned at the end, will serve. The amount of air which is allowed to escape by such a nozzle has to be regulated, and this can be done with perfect precision by means of a screw clamp on the rubber tubing. Sufficient resistance can thus be applied to insure that the internal pressure will be strong enough to force air also through the kind of nozzles that are required for the production of fine streams of bubbles. For these a dried and partly decayed branch of some suitable wood forms a simple outlet. Attach a rubber tube to a side branch and make some notches along the main one. From each of these notches as well as from

the cut ends, streams of bubbles will emerge when the apparatus is working. A bit of dried hawthorn as thick as one's little finger, which has been dead and exposed to the weather for a year or more, gives an extremely fine division of the air. But most purposes will be served quite well by woods with coarser vessels. Insufficient previous weathering is apt to give trouble through swelling taking place after immersion. An air valve may with advantage be set in the main stem of the rubber tubing in order to obviate all tendency to reflux, or better still, a valved extensible air reservoir with suitable recoil may be interposed, thus eliminating altogether intermittence of aeration. It goes without saying, also, that special arrangements may be added, such as those which Browne* has so successfully devised for the growth of hydroids.

To sum up, the influx of water through A is constant, and the sequence of events is as follows:—Rise of pressure in C; rise of water in E and F; forcing of air through the aerating nozzles; overflow of surplus water through G; filling up of C; commencement of siphon action; flowing back of water from F into C; entrance of air into C; emptying of water into C; cessation of siphon action; recommencement of rise of pressure in C.

The apparatus can be fitted up wherever there is a constant water supply fresh or salt, under even a slight degree of pressure. It works quite automatically, and after being properly adjusted requires no attention except in arranging the nozzles from time to time to suit new aquaria, or the varying requirements of aquaria already established. No active damage can be done to the aquaria even though the siphon action from any cause (e.g. leakage or slackening of inflow) should temporarily cease.

The air used is freed from most of its soluble and suspended impurities through entering by the long wet tube F, bubbling up through the water in B, and remaining for a time within C, into which there is a constant inflow of water. By way of further precaution, the air entering at M may be filtered through cotton wool. Thus the atmosphere even of a city laboratory, may be rendered practically harmless.

The intervals of pause and of active aeration can be varied within wide limits, as also can the periodic time of both. Or the whole apparatus can be stopped and re-started after a time (e.g. to imitate tidal conditions) by turning the water-tap.

A single aerator on the scale indicated above will provide continuous and efficient aeration for as many as thirty small aquaria. Increase in the sizes of the parts gives an increased supply of air, while by heightening the various tubes the internal pressure can be brought up almost to the limit of pressure of the water supply.

* Journ. Marine Biol. Assoc. United Kingdom, n.s. viii. No. 1, pp. 37-43.

The aerator has been fully tested in the Embryology Laboratory at Glasgow University during the eight months that have elapsed since the author first employed it there in its present form. A similar instrument fitted up by him at the Millport Marine Station in the beginning of September last has also worked with regularity. It was at the latter Institution, several years ago, that his first experiments directed towards designing such an aerator were made.

NOTE.

*Convenient Form of Stand for Use as a Micro-Colorimeter
and with the Micro-Spectroscope.*

By MARSHALL D. EWELL, M.D., F.R.M.S.

THE apparatus shown in fig. 2 was constructed for use with Lovibond's standard coloured glass slides, or with the micro-spectroscope. It will be seen that the apparatus consists of two objectives carried by tubes screwed into a prism-box. The 12 mm.

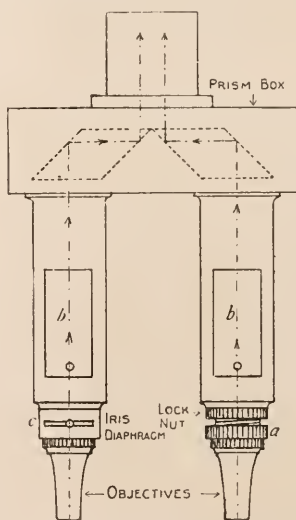

FIG. 2.

Spencer objectives are matched, and in order to absolutely secure equality of working distance, one of them (the right-hand one) is fitted with an adapter with the Society's thread, male at the upper end, and female at the lower. When the matching has been satisfactorily attained a lock-nut clamps the objective, and the two par-focal objectives can then be simultaneously focused by the ordinary slow motion. The Lovibond tinted glasses are inserted

in the openings *b, b*, closed by tubes sliding within the larger Microscope tubes. In order to regulate the intensity of the light, an iris diaphragm is interposed in the left-hand tube at *c*. The prism-box contains a pair of reflecting rhombs, and the course of the rays is shown by the dotted lines. Thus the effect is to

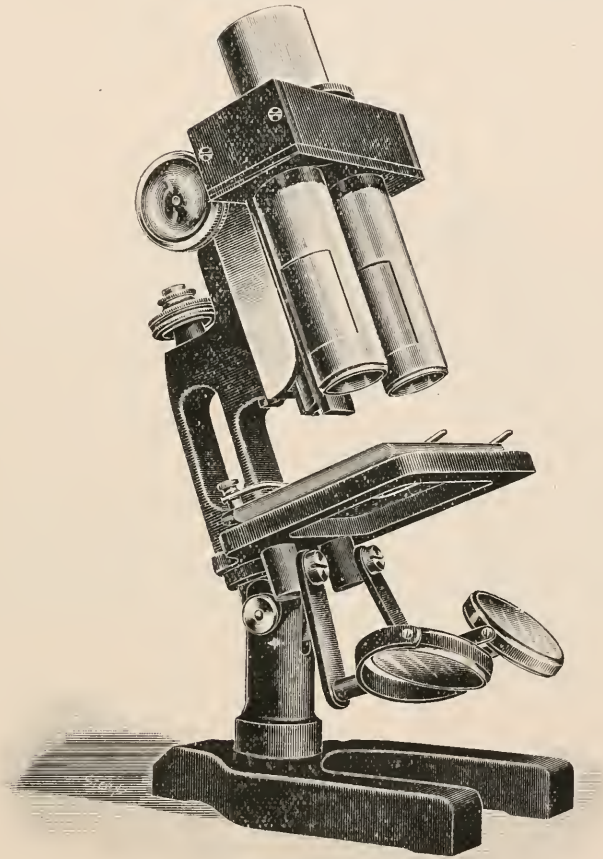

FIG. 3.

oppose two images which readily lend themselves to comparison. Fig. 3 shows the apparatus fitted to a Spencer Lens Co.'s stand. With the exception of the stand, the residue of the outfit was made by Dr. Ewell in his amateur shop.

The general idea recalls Inostranzeff's comparison chamber or

microscopic comparer,* in which a prism chamber (see fig. 3) consisted of a horizontal tube with two vertical arms. These arms fitted into the tubes of two Microscopes, and the horizontal chamber contained four prisms. Two images, conveniently apposed for comparison, appeared in the eye-piece chamber. This idea was somewhat improved upon by van Heurck.†

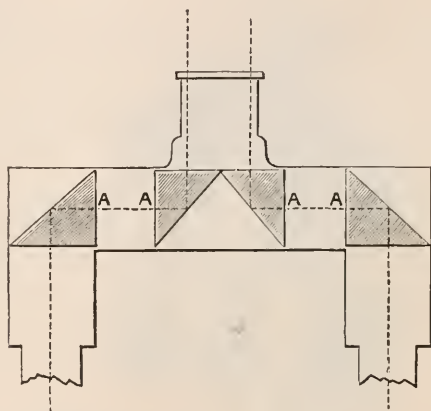

FIG. 4.

It will be noticed that Dr. Ewell's design, which has been independently evolved, is an advance in several respects. It requires only one Microscope; it secures par-focality of objectives, and, owing to the use of only two prisms, the loss of light at *A, A* (fig. 4) is avoided.

* See this Journal, 1886, p. 507.

† *Op. cit.*, 1887, p. 463.

SUMMARY OF CURRENT RESEARCHES
RELATING TO
ZOOLOGY AND BOTANY
(PRINCIPALLY INVERTEBRATA AND CRYPTOGAMIA),
MICROSCOPY, ETC.*

ZOOLOGY.

VERTEBRATA.

a. Embryology.†

Structure of Mammalian Ovary.‡ — H. von Winiwarter and G. Sainmont find smooth muscle tissue in the ovary of the cat. It retains the character of young tissue. It occurs only in the parenchymatous zone in the vicinity of growing follicles, to which it forms an external theca. The latter persists, after the follicle bursts, as the capsule of the corpus luteum. In the mesovarium there is much greater muscularity: longitudinal bundles in two planes. These effect erection of the ovary at the time of rut. The authors also describe a principal and an accessory ganglion associated with the epoophoron, which have probably to do with the innervation of the ovary.

Ovarian Glands.§ — P. Bouin and P. Ancel distinguish Mammals with spontaneous ovulation, and Mammals in which the ovulation is provoked by copulation. The former have two kinds of corpus luteum, according as the ovulation is not, or is, followed by fertilisation—the periodic corpora lutea of menstruation, and corpora lutea of pregnancy. Mammals, with non-spontaneous ovulation, have only the second kind of corpus luteum—the gestative corpus luteum. To the first category the authors refer man, primates, dog, horse, cow, pig; to the second, the rabbit, the guinea-pig, the mouse, and the cat. The ovaries of the first set have no interstitial gland, and it may be said that the periodic corpus luteum corresponds to the interstitial gland which occurs in Mammals of the second set.

In another paper || the authors maintain that the phase of cellular proliferation in the mammary gland is determined by corpus luteum.

* The Society are not intended to be denoted by the editorial "we," and they do not hold themselves responsible for the views of the authors of the papers noted, nor for any claim to novelty or otherwise made by them. The object of this part of the Journal is to present a summary of the papers *as actually published*, and to describe and illustrate Instruments, Apparatus, etc., which are either new or have not been previously described in this country.

† This section includes not only papers relating to Embryology properly so called, but also those dealing with Evolution, Development, Reproduction, and allied subjects.

‡ Arch. Biol., xxiv. (1909) pp. 627-51 (1 pl. and 7 figs.).

§ C.R. Soc. Biol. Paris, lxxvii. (1909) pp. 464-6.

|| Tom. cit., pp. 466-7.

Feb. 16th, 1910

C

Head of Embryo Chlamydoselachus.*—Paul Brohmer has studied the cavities of the head and the nerves in this type. Two of his conclusions may be stated. Platt's head-cavity is absent in some Selachians (*Chlamydoselachus* and *Torpedo*); in the others it is comparable to the diverticula which arise from the mandibular cavity, and are subsequently constricted off. These have no significance in connection with the head problem. The third head-somite of Van Wijhe is the upper portion of the hyoid cavity. In young embryonic stages the two form one cavity, but the upper part is subsequently separated off and seems independent.

Development of Heart in Teleosts.†—I. Borcea finds in *Belone*, and other Teleostean fishes, that the heart and the migratory vascular cells (which form the vitelline network), arise from part of the cephalic mesoderm, corresponding to the intermediate mesodermic masses in the trunk. On the other hand, the pigment-cells have an ectodermic origin.

Intermediary Mesodermic Mass in Teleost Embryos.‡—I. Borcea has studied, in various types (*Belone*, *Exocoetus*, *Gobius*, etc.), the intermediary differentiation of mesoderm which was first described by Oellacher. He finds that it gives origin to the endothelium of the blood vessels, the blood corpuscles, the renal canaliculi, and the lymphoid tissue of the kidney.

Development of Marsupial Skull.§—R. Broom gives an account of his observations on the development of the skull in *Trichosurus vulpecula* and *Dasyurus viverrinus*. We cannot do more than refer to a few points. There is a remarkable resemblance between the skull of the very young *Echidna* (as described by Gaupp), and that of the young *Dasyurus*. "In fact, the *Dasyurus* skull resembles that of *Echidna* more than it does that of *Trichosurus*."

The parachordals and trabeculae are very definite structures, but the occipital region is not very clearly differentiated from the parachordal. The trabeculae form all the median, basal cartilage in front of the parachordals. The paraseptals are probably true parts of the nasal capsule, the base of the latter being trabecular. A large lateral cartilage, which the author calls orbitosphenoid, seems to be as definitely a cranial element as the trabecula. It is continued backwards, and fuses with the auditory capsule, though quite distinct from it. There is some reason to consider that the supra-occipital is the further continuation of the same band. Broom argues in support of the rather startling conclusion that the element which develops into the alisphenoid is a specialisation of a rudiment of the palatopterygoid arch.

Blood-formation in Embryonic Mammalian Liver.||—S. Mollier finds that in embryos of man, cat, rabbit, etc., blood-cells are formed in the liver from an indifferent material, the reticulum. This is due to the visceral layer of the mesoderm, and differentiates into endothelium,

* *Jenaische Zeitschr. f. wiss. Nat.*, xlv. (1909) pp. 647-98 (4 pls. and 15 figs.).

† *Comptes Rendus*, cxlix. (1909) pp. 688-9. ‡ *Tom. cit.*, pp. 637-40.

§ *Proc. Linn. Soc. N.S.W.*, xxxiv. (1909) pp. 195-214 (8 pls.).

|| *Arch. Mikr. Anat.*, lxxiv. (1909) pp. 474-524 (4 pls. and 8 figs.).

blood-cells, and supporting tissue. The liver is at first a predominantly erythropoietic organ, and the author gives a circumstantial account of its activity.

Development of Head of Gymnophiona.*—Harry Marcus continues his study of *Hypogeophis* embryos. The most anterior roof of the archenteron consists of vegetative cells, and here, in contrast to the trunk, the notochord has an endodermic origin, and there are typical mesodermic coelom-cavities. The development of the head-cavities and the mesoderm is described. The columella auris arises from the hyoid arch, and is clearly separable from the auditory capsule blastema. The stapedial artery, which passes through the stapes in *Ichthyophis* is a branch of the second aortic arch. A corroboration of the homology of stapes and hyomandibular is found in the course of the 7th and 8th nerves. The author also describes the formation of the cerebral ganglia.

Abnormal Reproductive Organs in Frog.†—W. Youngman describes an interesting case—a large specimen of *Rana temporaria*. It had small thumb-pads, a normal ovary on the left, an ovo-testis on the right, two normal oviducts with eggs in them, normal ureters, no trace of vasa efferentia or seminal vesicles. The correlation of the two male characters suggests that the thumb-pad is the outcome of a physiological secretion in some way connected with the male sexual elements.

Spermatogenesis of Fowl.‡—M. F. Guyer finds that accurate enumeration of the spermatogonial chromosomes is very difficult. Seventeen is probably the correct number, but it is safer simply to say that there are not less than fifteen, not more than nineteen.

Nine chromosomes ordinarily appear in the prophase of the first division of the spermatocytes. Of these, eight are presumably bivalent. The other, which is the "odd" or "accessory" chromosome, has not paired at this time, but is nevertheless probably a compound body consisting of three elements.

The odd chromosome not infrequently reveals a tripartite structure. Less often one of its components seems to stand more or less apart, like a "supernumerary" chromosome. The odd chromosome passes undivided to one pole in the vast majority of cases, so that one daughter-cell receives eight and the other nine chromosomes.

In the second division of the spermatocytes the eight chromosomes of the former division pair to form four chromosomes. Likewise, eight of the nine which passed to the other daughter-cell pair to form four, but the odd one remains unpaired. In this second division the odd chromosome, after lagging somewhat, divides, and thus there are formed two spermatids each containing five chromosomes. The spermatids formed from the division of secondary spermatocytes which contained but four chromosomes, receive only four chromosomes each. Thus the final result of the two divisions of the spermatocytes is the production of four spermatids, two of which receive four, and two five chromosomes.

* Morphol. Jahrb., xl. (1909) pp. 105-83 (3 pls. and 37 figs.).

† Anat. Anzeig., xxxv. (1909) pp. 301-3 (3 figs.).

‡ Tom. cit., pp. 573-80 (2 pls.).

As in the guinea-fowl, two sizes of spermatozoa are produced. The transformation of the spermatid nucleus into the head of the spermatozoon comes about through the gradual concentration of the chromatin into an elongated curved mass at one side within the nucleus, and the subsequent elongation of this mass.

Vitality of Spermatozoa.*—C. Fleig has made many experiments as to the survival of human spermatozoa in various fluids. After being "washed" in a centrifugal machine with much fluid—to get rid of albumin—spermatozoa will live in mineral waters or sea-water for two or three days. The presence of lime-salts seems to be necessary for sustained movement. If the mineral water is placed in a refrigerator, the spermatozoa remain alive for five or six days after emission. In the case of pure seminal matter put into the refrigerator, there was re-vivification of spermatozoa after eight days.

Hyperdactylism in Fowls.†—D. Barfurth experimented with Orpingtons, normally 4-toed, which exceptionally produce 5-toed forms. Seven hyperdactylous hens (two years old) were paired with a normal cock of the same age, and of the 152 chickens produced between May and July 1908, 80 were normal and 72 hyperdactylous. The influence of the two parents is equal.

b. Histology.

Minute Structure of Food Canal in Cyprinoid Fishes.‡—A. Pictet gives a histological description of the alimentary tract in carp and tench and other Cyprinoids. He gives an account of the buccal cavity, the gullet, and the intestine. One of his general points is that the buccal epithelium includes the same elements as the epidermis (flat cells, large calciform cells, and terminal buds), and that the same kinds of cells occur beyond the gill-clefts to the end of the œsophagus. This would seem to indicate that the boundary between the ectodermic stomodæum and endodermic mesenteron was very far back.

New Mode of Nuclear Division.§—Enzio Reuter describes what he calls merokinesis—a new mode of nuclear division observed in the fertilised ovum and the larger blastomeres of a mite *Pediculopsis graminum*. The nuclear content prepares for mitosis not as a unified structure, but in the form of four independent parts or karyomeres, each corresponding to the area of an individual chromosome. These nuclear parts divide with their membrane intact. The chief peculiarity is that each karyomere, i. e., each nuclear part corresponding to a chromosome, divides normally and regularly by itself. It may be a phyletic stage in karyokinesis.

Thymus of Reptiles.||—A. P. Dustin has made a detailed study of this organ in twelve species of tortoises, snakes and lizards. As to the development, he finds that the small thymus cells arise directly

* C. R. Soc. Biol. Paris, lxxvii. (1909) pp. 162-4.

† Arch. Entwickmech., xxvi. (1909) pp. 631-50. See also Zool. Zentralbl., xvi. (1909) pp. 425-6. ‡ Revue Suisse Zool., xvii. (1909) pp. 1-73 (2 pls.).

§ Acta Soc. Fennica, xxxvii. (1909) pp. 1-52 (40 figs.);

|| Arch. Zool. Exper., ii. (1909) pp. 43-227 (5 pls.).

from the endodermic branchial primordia. As to the adult organ, there is but one characteristic element, the small thymus cell. The others are secondary mesodermic importations—connective cells, myo-epithelioid cells (Hassall's corpuscles), granular cells and leucocytes, vascular epithelium, and blood corpuscles. The seasonal and definite involution of the thymus is carefully discussed. As to function, the Reptilian thymus shows a seasonal alteration of great activity and repose, the former gradually waning. During activity the thymus is alternately the seat of vascular neo-formation and retrogression. The small thymus cells are actively divided, but the organ is not lymphopoietic, or leucopoietic, or erythropoietic. Nor is there any specialised secretion. Its activity is seen in changes in the number of small thymus cells. The myo-epithelioid cells and Hassall's corpuscles are metaplastic forms of connective cells produced under the action of the small thymus cells.

Phosphorescent Organs of Fishes.*—O. Steebe describes the phosphorescent organs of two surface fishes, *Anomalops kataptron* and *Photoblepharon palpebratus*, occurring in the Malay Archipelago. He was able to observe them frequently under natural conditions, and to keep them alive in captivity for some time. Morphologically, the known luminous organs of fishes may be arranged in two series. The first series consists of acinous glands; it begins with open forms, but, as specialisation proceeds, these may lose their ducts and become round sacs with no lumen, and with hardly any indication that they are made up of glandular tubules. The organs of this series usually occur on the head or appendages, so that their light illumines the animal's field of vision. Those of the first series are much more richly supplied with blood and nerves than those of the second. The most important constituent of the second series is also glandular cells, but these are not disposed to form typical glands. They form an accumulation of individual cells with no lumen, except in Gonostomidæ. They are derived from differentiated epidermal cells, which have become united and transferred to the cutis. It is still uncertain whether the glandular cells are the starting-point of this development, or whether the organs are derived from sensory papillæ.

The organs of the second series are smaller but much more numerous than those of the first, and they are sparingly supplied with blood and nerves. They contain lenticular cells, and occasionally gelatinous matrix, differentiations which never occur in the first group. The lenticular cells occur even in very primitive organs. Even the simple epidermoidal organs show a characteristic orientation to the surface of the body in accordance with their position on the trunk, in the same way as the most highly developed representative of the group.

Functionally, the two groups also differ markedly from one another. In the first group the luminosity is usually extra-cellular, arising within the cells only in the most extremely modified organs. It is, as far as observations have shown, constant and very intensive. No kind of stimulation has any effect on it. The organs of the second group

* Zeitschr. wiss. Zool., xciii. (1909) pp. 345-405 (3 pls. and 5 figs.).

respond very slowly to stimulation. Their luminosity increases very gradually to a maximum and dies slowly down again, fluctuations taking place from time to time. The organs of the two forms studied belong to the first group, and are most nearly related to the suborbital organs of the Stomatidae. But they differ from these in various particulars, especially in that they are complexes made up of a number of open glands. They are relatively, and perhaps absolutely, the largest phosphorescent organs occurring in fishes, and this is the more remarkable since their possessors do not live in the deep sea. Physiologically they are especially important as the only representatives of the first group which have been carefully observed. The phosphorescence is extracellular but intra-glandular, and is constant. A luminosity of the same character is unknown anywhere else in the animal kingdom. In a note appended to his paper the author discusses Brauer's work on the phosphorescent organs of the fishes collected by the German Deep Sea Expedition.

c. General.

Diurnal Variations in Temperatures of Camels.*—J. Burton Cleland tested a number of camels recently imported from India to Western Australia. The results, though comparatively few, seem to indicate that the camel resembles, to some extent, cold-blooded animals such as reptiles, inasmuch as there is a wide range of temperature, varying with external conditions, the oscillations sometimes being as much as nearly 8° F.

The sub-normal temperature would appear to be due to the coolness of the mornings, the lack of active exercise, and the completion of rumination some time previously. The higher temperature, found in the evening, after hot days, is perhaps to be attributed to the small amount of visible perspiration, which seems restricted to an area on the back of the neck. This is an adaptation to conserve the animal's water-supply in arid regions.

Immunity of Lerot to Viper's Poison.†—G. Billard injected large doses of viper's poison into the lerot (*Eliomys nitela*), a kind of dormouse, and found that there were no ill effects. He observed that these little animals are very pugnacious, and fight fiercely with vipers. On one occasion a large viper bit a lerot badly in the eye, but there was no sign of poisoning. It is usually said that the only Mammals immune to snake-poison are the hedgehog, the pig, and the mongoose.

Colours of Equidæ.‡—R. I. Pocock discusses the coloration of horses, zebras, and tapirs. He thinks that Johnston's view of the coloration of Equidæ is correct, namely, that they are descended from dark-coloured animals patterned with white spots, running into longitudinal lines originally, and at a later stage in evolution becoming arranged in transverse bars over the neck and body. It is this view of the question which gives special interest to the coloration of dapple-grey horses; for if the white spots of these horses represent phylogenetically

* Proc. Linn. Soc., N.S.Wales, xxxiv. (1909) pp. 268-71.

† C.R. Soc. Biol. Paris, lxxvii. (1909) pp. 90-1.

‡ Ann. Nat. Hist., iv. (1909) pp. 404-15.

the white spots of a tapiroid progenitor, we see in this dapple pattern a stage in the evolution of equine coloration antecedent to the banded zebroid pattern hitherto regarded as the most primitive pattern extant in the Equidæ.

Albinism.*—A. F. de Seabra discusses the albino types in the Lisbon Museum, e.g., mole, rat, mouse, *Microtus subterraneus*, *Oryctolagus cuniculus*, *Cervus aris*, *Phascolarctus cinereus*, house martin, sparrow, starling, *Buteo vulgaris*, *Balearica pavonina*, *Amblystoma tigrina*, and two fishes, *Batrachus diductylus* and *Pseudotriacis microdon*.

Struggle for Existence among South African Rats.†—H. Lyster Jameson, in the course of a report on a collection of S. African Mammals, has some interesting notes on *Mus microdon zuluensis* Thos. and Schw. This multi-mammate rat approaches more nearly in its habits to the imported *M. decumanus*, *M. rattus*, and *M. musculus* than any other native species. They occur everywhere, and become a pest in houses. Although it is fierce and aggressive, it is unable to compete with the imported forms, and has consequently disappeared in the larger towns, where the latter have become established.

Jameson has also interesting notes on *Mystromys albicaudatus* Smith, which was found living in a warren occupied by the meerkat (*Suricata*). Litter seems to succeed litter at intervals of thirty-seven days throughout the year. The female carries her young about attached to her mammæ, and if one happens to become detached she picks it up in her mouth and carries it back to the nest. The young ones are thus dragged about until a week before the next litter is born. Re-impregnation occurs a few hours after the birth of the litter. Cats will not eat this species, presumably because of some protective secretion.

Variation in Comb of Domestic Fowl.‡—Raymond Pearl and Maud Dewitt Pearl give a description of the nature and amount of variation normally occurring in a homogeneous pure-bred strain of barred Plymouth rock hens in respect of form and size of the comb. There appears to be continuous variation, considerable in amount, in every definable characteristic of the comb. All degrees of intergradation between the extreme conditions of each of the characteristics regularly occur.

Variations in *Tropidonotus*.§—Louis Roule has studied variations in colour, in the relation of the length of the head to the length of the body, and in the scales. He discusses the question of species, and contrasts, for instance, the well-defined, strictly unimodal *T. viperinus*, and the extremely variable plurimodal *T. natrix*.

Attitude of Dinosaurs.||—O. Abel argues against the view that Sauropoda had a crocodile-like position of limbs and mode of progression. The structural features of the carpus and tarsus are in favour of an upright position of the limbs.

* Bull. Soc. Port. Sci. Nat., 1909, pp. 256-63.

† Ann. Nat. Hist., iv. (1909) pp. 455-74.

‡ Biometrika, vi. (1909) pp. 420-32 (3 pls.).

§ Arch. Zool. Expér., ii. (1909) Notes et Revue, No. 1, pp. i.-xvii.

|| Verh. Zool. Bot. Ges. Wien, lix. (1909) pp. 117-23.

Lungless Salamandrid.*—G. Dehaut adds *Euproctus montanus* from Corsica to the list of Salamandridæ which occur without lungs (e.g. *Spelerpes fuscus* and *Salamandrina perspicillata*). He notes that the cutaneous poison has no odour; that it has a sharp and astringent taste; and that lizards which bite *Euproctus montanus* have violent convulsions.

Seasonal Migration of Fat in the Frog.†—J. Athanasiu and J. Dragoiu have studied the movement of fat in the frog's body at different seasons. They find, for instance, that in spring the fat leaves the muscular fibres and re-enters the circulation. Part of it is eliminated with the urine.

Studies on Fishes.—L. Dollo‡ discusses the position of the pelvic fins in Teleosteans, with special reference to those which he believes are secondarily abdominal, e.g. Atherinidæ.

G. Schlesinger§ discusses the sagittiform type of body in free-swimming fishes, such as *Sphyræna tome*, *Perophis brasiliæanus*, and *Cyema atrum*, and the various ways in which this adaptive shape may be attained.

Capillary Phenomena in Life of Fresh-water Animals.||—F. Brocher has studied the following cases:—

A. Capillary action on animals in which the body is not wetted (or very partially).

I. Where the whole body is not wetted.

1. The animal lives in air (Hydrometrids, Podurids, etc.).
2. The animal is amphibious, smooth (*Gyrinus*), or covered with hairs which do not wet (*Parnus*, *Amalus*, Hydrophilids, and *Notonecta*).
3. The animal lives in water (Cladocera, Ostracods, and various larvæ).

II. Where small parts of the body are wetted.

1. The animal lives in air (*Podura*).
2. The animal lives in water (*Haliplus*).

B. Capillary action on animals in which the body is wetted either wholly or in greater part.

I. Where the whole body is wetted.

1. The animal lives in water (Hydrophilids, below the surface, or larvæ of *Dixa* at the surface).
2. The animal is amphibious (Nemerteans and various larvæ).
3. The animal lives in the air (Ephemeroidea).

II. Where parts of the body are not wetted.

1. Considerable areas (*Argyroneta* and Hydrophilids).
2. Small parts (larvæ of Gnats).

* C.R. Soc. Biol. Paris, lxvii. (1909) pp. 413-14.

† Tom. cit., pp. 135-7.

‡ Verh. Zool. Bot. Ges. Wien, lix. (1909) pp. 135-40.

§ Tom. cit., pp. 140-56 (7 figs.).

|| Revue Suisse Zool., xvii. (1909) pp. 91-112 (8 figs.).

Structure of *Asymmetron bassanum* Günther.*—Esther R. Morris and Janet Raff describe this species of lancelet which is not uncommonly met with at depths up to twenty fathoms in certain rather restricted areas along the Victorian coast. The average myotome formula is 44, 17, 14; at the anterior end there is always an incomplete ring of pigment, the oral cirri are 24 to 26 in number, and bear sense-papillae, the ventral fin is divided into fin-chambers, the gonads are in a single series on the right side and vary in number from 25 to 30. Beyond the atriopore the atrial cavity is continued back and divides into two cæca surrounding the intestine, and separating the cœlom from the body-wall except on the ventral surface. This paired post-atrioporal cæcum is distinctive.

Relation of Entozoa to Bacterial Disease.†—A. E. Shipley discusses a case of the Nematode *Cystidicola farionis* in the swim-bladder of some rainbow trout, where it seems clear that the Nematode, in piercing through the intestinal wall, traversing the intermediate tissues, and entering the swim-bladder, had inoculated that organ with bacterial disease. He cites other cases of a similar sort, which suggest that the Entozoa in our digestive organs may be playing a part similar to the biting and piercing Entozoa, as disseminators of microbes.

Tunicata.

Australian Tunicates.‡—H. Leighton Kesteven describes a number of new forms. A new genus *Silneioides* combines the characters of *Sidnyum* and *Polyclinum*; in general features it closely resembles both, differing from the former and resembling the latter in having the wall of the stomach smooth; and resembling the former and differing from the latter in the absence of an atrial languet.

INVERTEBRATA.

Mollusca.

a. Cephalopoda.

Beaks of Fossil Cephalopods.§—Alfred Till finds that it is possible to distinguish fossil *Nautilus*-beaks from others which are "not *Nautilus*," and even to distinguish a few "genera" of beaks.

β. Gastropoda.

Development of Pulmonary Cavity in Slug.||—Paul Heyder has studied the development of *Arion empiricorum* Fér. var. *rufus*, with special reference to the pulmonary cavity. He also discusses the primitive kidney, the definitive kidney, the heart, and the pericardium. The primordium of the pulmonary cavity appears before there is any hint of the mantle fold. The branchial cavity of Prosobranchs is a deep insinking of the mantle groove; branchial cavity and pallial cavity are

* Proc. R. Soc. Victoria, xxii. (1909) pp. 85-90 (3 pls.).

† Journ. Econ. Biol., iv. (1909) pp. 61-71 (1 fig.).

‡ Proc. Linn. Soc. N.S. Wales, xxxiv. (1909) pp. 276-95 (3 pls.).

§ Verh. Zool. Bot. Ges. Wien, lix. (1909) pp. 123-9.

|| Zeitschr. wiss. Zool., xciii. (1909) pp. 90-156 (3 pls. and 6 figs.).

the same. But in Pulmonates (Stylommatophora) there is a clear difference between the primary pulmonary cavity and the secondary mantle cavity. The lung of Stylommatophora is a special organ: it is not a part of the general mantle cavity, but simply opens into it like the ureter or genital duct. The branchial cavity of Prosobranchs is represented in *Arion* by the deeply insunk right portion of the mantle groove, which for a time receives the opening of the pulmonary cavity. Lung and mantle-cavity are quite different, but branchial cavity and mantle-cavity are the same.

Polar Bodies in *Arion empiricorum*.*—Honoré Lams describes the large ovum of this slug, the expulsion of the two polar bodies, the division of the first, and the reduction of the chromatin. He records a number of curious anomalies, such as gigantic polar bodies.

Topographical Memory in Limpet and in *Calyptrea*.†—H. Pieron has made numerous observations and experiments showing the "homing" habit in both of these Gastropods. He confirms previous work on the limpet, and maintains that this animal has a knowledge not only of its particular spot, but of its surroundings. By a method of exclusion he shows that we must at present believe that the limpet has a topographical memory. In *Calyptrea* there is also evidence of "homing," but it seems to be less precise.

New Family of *Æolididæ*.‡—A. Vayssière establishes a new genus *Eliotia*, nearly related to *Madrella*. The two are referred to a new family (Madrellidæ) within the *Æolididæ*. In the new family the dorsal tentacles, or cylindro-conical rhinophores, show round their upper half numerous tubular, simple, contractile digitations. There are massive, very thick, horny, but somewhat soft jaws, not lamellar as in *Æolids* in general. The new family should be ranked near the *Coryphellidæ*. Vayssière found the type of his new genus, *Eliotia souleyeti*, among the debris of Polyzoa in the Gulf of Marseilles.

Adductor Muscles.§—F. Marceau has made a detailed study of the structure and functioning of the adductor muscles in a representative series of bivalves. He discusses the nacreous and vitreous portions, the contractility, the force exerted, the relation between the structure of the fibres and the rapidity of their contraction, and many other points. We may refer to the interesting discussion of fibres with smooth helicoidal fibrils, which, though quite different from cross-stripped muscle, are able to contract with equal rapidity.

♂ Lamellibranchiata.

Malacology of Equatorial Africa.||—L. Germain gives an account of the fresh-water bivalve *Chelidonopsis*, a highly evolved genus of *Mutelidæ*. He discusses the differences between *Mutelidæ* and *Unionidæ*, and the various genera of *Mutelidæ*. He considers the molluscan fauna of Equatorial Africa in general, and seeks to map out the migratory paths of

* Arch. Zool. Expér., ser. 5, i. (1909) Notes et Revue, No. 1, pp. i-ix. (1 fig.).

† Tom. cit., pp. xviii.-xxix. ‡ Comptes Rendus, cxlix. (1909) pp. 636-7.

§ Arch. Zool. Expér., ii. (1909) pp. 295-469 (4 pls. and 91 figs.).

|| Op. cit., i. ser. 5 (1909) pp. 1-195 (2 pls.).

the various types. There is (1) a northern province belonging to the Palaearctic region: (2) an equatorial province showing affinities with the molluscan fauna of tropical America and the Indian peninsula: and (3) an australo-african province, with a very archaic fauna, approaching that of Patagonia, Australia, and New Zealand. Many very interesting conclusions are drawn as regards geographical distribution.

Arthropoda.

a. Insecta.

Outlines of Entomology.*—O. W. Estlund has published a student's guide to the study of entomology. It is of the nature of a synopsis, giving terse and clear notes on the various systems in their structural and functional aspects, and its particular characteristic is that the entomological facts are used to illustrate biological methods and results.

Case of Defensive Mimicry.†—J. Bourgeois refers to G. A. K. Marshall's observation of *Ceria gambiana* (one of the Diptera) visiting flowers in company with *Polistes marginalis* (one of the Hymenoptera). He has observed a similar case. He saw *Ceria conopsoides* visiting the wounds on the trunk of a horse-chestnut along with the Hymenopteron *Odynerus crassicornis*. Both visited the tree with the same end—to lick the exudation, and the Diptera were doubtless protected by their Batesian mimicry of the formidable Hymenoptera.

Studies on Hymenopterous Parasites.‡—F. Silvestri has studied *Prospalta berlesi*, a Hymenopterous parasite of *Diaspis*, and points out among other interesting facts that no adult male was found among many hundreds of specimens. The species may be permanently parthenogenetic.

The author also describes the development of *Ageniaspis fuscicollis* Dalm.§ giving details regarding the maturation, fertilisation and segmentation of the ova. In the case of the parthenogenetic ova, as in those which are fertilised, there are two polar bodies, which remain distinct and form what Marchal called the paranucleus of the trophamnion, dividing directly and irregularly. The protoplasm of the egg does not wholly go to form embryonic cells, the peripheral part forms an involucre, which Marchal calls the trophamnion. The polar part of the ooplasm and the polar bodies have a protective and nutritive role in relation to the embryonic part. During the formation of the polar bodies the nucleolus remains unchanged in the posterior part of the ovum: it passes into one of the first two segmentation cells, and seems, as in *Litomastix truncatellus*, to have a retardative action on the cell in which it occurs, and to retain a determinant of the genital cells. From one ovum 10–15 embryos develop. There are three generations in a year as in the insect victimised, *Prays oleellus* Fabr.

Another form studied by Silvestri is *Encyrtus aphidivorus*. It is

* Outlines of Entomology. I. Anatomy and Physiology. Minneapolis, 1909, 44 pp.

† MT. Schweiz. Entom. Ges., xi. (1909) pp. 395-6.

‡ Boll. Lab. Zool. Scuola Agric. Portici, iii. (1909) pp. 22-8 (6 figs.).

§ Tom. cit., pp. 29-85 (2 pls. and 42 figs.).

not a parasite of Aphides, as its name suggests, but lays its eggs in dead Aphides containing the larva of a Braconid (*Aphidius brassicæ* Marsh), or this larva already parasitised by a Cynipid (*Allotria vittrix* West, var. *infuscatu* Kieff). As in *Litomastix* and *Ageniaspis* the completely developed oocyte of the first order has a nucleus anteriorly and a nucleolus posteriorly. The non-fertilised eggs develop into males. There are always two polar bodies, which play no part in development. The nuclei divide in segmentation, but the ooplasm remains undivided. In the cell which receives the nucleolus and in its descendant cells there is a retardation of multiplication. The ovum gives rise to only one embryo.

In *Oophthora semblidis*, which develops in the eggs of *Mamestra brassicæ*, the sequence of events is very much the same as in *Encyrtus*, but the form of the larva is very different.

Biology of Myrmecophila.*—F. Schimmer publishes a contribution towards a monograph of the genus *Myrmecophila* Latr. He deals mainly with the forms found in ants' nests, especially with *M. acervorum*, which was the only species that could be procured alive and kept under observation. Only eleven forms of *Myrmecophila* are known, but these are distributed over all five regions of the earth. *M. prenolepidis* and *M. americana* Sauss. are identical. Wasman's hypothesis of transportation is probably the true explanation of the wide distribution of this form. Although, as has been already established, all the myrmecophilous crickets, with the possible exception of *M. americana*, may be found associated with several hosts, yet in each region of their occurrence a few species of ant seem to be preferred; thus *M. acervorum* is usually found in the nests of *Lasius niger*, and in suitable localities of *Myrmica rubra*. The reason for this preference is probably an adaptation in the relative size of host and guest. The biological reason for the symbiotic relation is to be found in the protection and food that the crickets find in the nests of their hosts. They get this food in several ways: by licking the ants, by robbing the workers returning to the nest with stores, or the newly fed larvæ, by sharing in the feeding of two or more ants, or, finally, they may be fed directly by the ants. The psychological basis of the relation lies in the different instinct mechanisms of the guests, not of the hosts (instincts of licking, of plundering, of demanding food). The mechanisms of movement which come into play in this symbiotic relationship are, on the one hand, of a mimetic nature (imitation of the ants' social instincts: the cleaning instinct, the demanding food by raising the forelegs, and the imitation of the movements of the antennæ); on the other hand, they are contrary to the corresponding mechanism of movement in the ants (circular, instead of straight movement, and power of leaping). The co-operation of these two kinds of movement secures for the crickets an apparent toleration on the part of their hosts. Both mimetic and contrary movements may, under favourable conditions, fail of their effect even with the true host, and they may produce the same or a similar effect on strange ants, as they normally do on the host.

* Zeitschr. wiss. Zool., xciii. (1909) pp. 410-531 (3 pls. and 6 figs.).

The reproduction of *M. acervorum* is purely parthenogenetic, that of *M. americana* purely amphigonous. The receptaculum seminis and the glandulæ ductus receptaculi in *M. acervorum* do not, however, show signs of becoming rudimentary. It is probable that in some species there is partial parthenogenesis associated with less frequent amphigonous reproduction (*M. ochracea*, *M. nebracensis*). Oviposition in *M. acervorum*, and probably in other species also, takes place within the nest of the host. The eggs are few in number, but of large size; they develop in about six weeks. Oviposition may take place at any time except during the winter months. *M. acervorum* may pass the winter in the nest of the host either as an imago or in the larval state. The usual duration of life is two years. This species (and probably others, also) follows its hosts when they change their nests. The crickets, like the ants themselves, are guided by their sense of smell. In regard to structure, the oval-shaped body and the leaping legs may be considered as adaptations securing the necessary rapidity of movement; the thickening of the antennæ and cerci, the widening of the antennal pits, and the thickening of the maxillary palps, as adaptations to the mimetic association with ants; and the hypopharyngeal tufts and hypopharyngeal ducts as adaptations for licking up the food. The parasitic habit has resulted in an increase in size of the head and intestine, and a slight dwindling of the proventriculus; while the rudimentariness of the dioptric apparatus of the faceted eye is probably due to the subterranean life. The small number of eggs, the size of the egg, and its abundant yolk-supply, are consequent on the diminished selection conditioned by the parasitic habit.

Eyes of *Dactylopius*.*—F. H. Kreckler has made a study of the common mealy bug, *Dactylopius destructor*, with a view to throwing some light on the abnormal condition presented by the family Coccidæ in regard to the number, condition and position of the eyes. He finds that the adult *Dactylopius* has three pairs of eyes, two accessory and one primary. The latter are bead-like, and lie on the ventral surface of the head. Of the former, an oval pair lies on the ventral surface, and a circular pair on the dorsal surface of the head. The accessory eyes have a large circular lens, followed by a comparatively thin layer of corneal hypodermis, encircling which is a single row of large iris cells. Below this there is a crescent-shaped area of polygonal rods, which are terminally situated on the retinal cells, and are separated from one another by a seam of denser material enlarged at its basal end. There is no grouping of rods or of retinal cells. From the proximal end of the retinal cells extend the nerve fibrils which join to form the optic nerve, which follows the contour of the head to enter the brain laterally. Reddish-brown pigment fills the retina, the iris, and also a ridge surrounding the eyes. There are no cells which function as pigment-cells alone.

The primary eyes are extremely small. They have no corneal hypodermis, no visual rods, no iris. There is a lens below which are a few retinal cells. The nerve fibrils leave the cell proximally, and the

* Zeitschr. wiss. Zool., xxxix. (1909) pp. 72-89 (1 pl.).

nerve joins that from the accessory eyes almost immediately. The stages in the development may be outlined as follows: The earliest primordia of the eyes are to be seen in the second nymphal period, when, through a proliferation and elongation of the hypodermis, two groups of cells are formed, one on each side of the mid-ventral line of the head, and also behind each of the antennæ on the dorso-lateral surface. By the third stage the areas on the ventral surface have increased sufficiently to meet, and the cells of the original groups protrude farther. The visual rods then appear. They grow out from the distal end of the cells. At practically the same time nerve-fibrils appear at the proximal end of these cells. After this the cells so far concerned sink below the adjoining hypodermis. In the earlier part of the fourth stage this hypodermis undergoes a change, and, pushing in from all sides, becomes superimposed on the visual rods, and forms the corneal hypodermis and the iris. These then secrete the lens. The depositing of the pigment keeps pace with the development of the lens.

Study of Puss Moth.*—G. Martelli has studied the habits and life-history of *Dieranura vinula*, and discusses their nocturnal activity, the death of the male after a first or at most a second copulation (which may last 12 hours), the oviposition, the four larval moults. As to parasites, it is noted that *Encyrtus vinulæ* and *Eupelmus* sp. attack the eggs and *Paniscus testaceus* the larvæ.

Vitellus in Silkmoth's Eggs.†—C. Vaney and A. Conte have traced the history of the vitelline globules that appear in the ovum about two hours after laying. Before the differentiation of a blastoderm the developing egg is a syncytium. This gives place to defined cells—some formative and others vitelline. A chromidial plexus around a number of vitelline globules becomes the centre of a vitelline cell. The vitelline cells are more than passive sacs; are not digested by the intestinal epithelium; their protoplasmic part absorbs the vitelline globules, and a nutritive fluid passes into the embryo by osmosis.

Intestinal Secretion in Deilephila.‡—Deegener gives a detailed account of the process of intestinal secretion in caterpillars of *Deilephila euphorbiæ*, describing seventeen stages.

Abdominal Sensory Organ in Noctuidæ.§—P. Deegener describes a new organ on the first segment of the abdomen in *Pseudophia lunaris*, *Plusia gamma*, etc. A duct leads into a cavity with ridges of sensory setæ. The function is probably auditory.

Development of Mid-gut in a Beetle.||—Jan Hirschler has studied the formation of the germinal layers and of the gut in *Gastroidea viridula* Deg. One of his general results is that the mid-gut has a multipolar origin. It is formed from two endodermic hoop-like primordia and several endoderm islands. It is wholly an endodermic product.

* Boll. Lab. Zool. Scuola Agric. Portici, iii. (1909) pp. 239-60 (12 figs.).

† C.R. Soc. Biol. Paris, lxxviii. (1909) pp. 87-8.

‡ Arch. Natur., lxxv. (1909) pp. 71-110 (1 pl.).

§ Zool. Jahrb., xxvii. (1909) pp. 631-50 (1 pl. and 1 fig.).

|| Bull. Acad. Sci. Cracovie, 1909, pp. 284-308 (1 pl. and 2 figs.).

Seed-infesting Chalcis Flies.*—C. R. Crosby describes the minute Hymenoptera, known as Chalcidoidea. He deals with some which depart from the usual insect-infesting habits of their relatives and are injurious to seeds. The apple-seed Chalcis (*Syntomaspis druparum*), the sorbus-seed Chalcis (*Megastigmus brevicaudis*), the rose-seed *M. aculeatus*, the Douglas fir-seed *M. spermotrophus*, and others are described.

Luminescence in Chironomus.†—J. C. Tarnani observed this in the sea of Azov in *Chironomus plumosus* and another species, but as it was also seen in moribund specimens he thinks it may have been due to bacteria. Luminescence has been previously reported in *C. plumosus*, *C. tendens*, and *C. intermedius*, but its nature remains obscure.

Pulex cheopis in Hamburg Docks.‡—W. Fromme found between January 1 and March 28, 1909, no fewer than 199 fleas (*Pulex cheopis*) on fifty-one rats and two mice from ships in Hamburg Docks. The importance of this is that *P. cheopis* carries the plague bacillus. The other fleas found on rats are: *P. irritans*, *P. felis*, *Ceratophyllus fasciatus*, *Ctenopsylla musculi*, *Sarcopsylla gallinacea*.

Nephrocytes and Pericardial Cells of Orthoptera.§—L. Bruntz shows that the nephrocytes which are able to eliminate ammoniacal carmine are not by any means confined to the pericardial region. The pericardial mass is certainly most important, but nephrocytes may occur in the most diverse places—around the salivary glands, about the fatty body, in the buccal appendages, and so on.

Nuclear Components in Sex-cells of Four Species of Cockroaches.||—Max Morse has compared *Periplaneta americana*, *Stylopyga orientalis*, *Blatta germanica*, and *Leucophaea maderiæ*.

An unpaired idochromosome or odd chromosome is present in the male of each of these species, and the spermatogonia possess one chromosome fewer than the oogonia.

In the spermatogonia the odd chromosome is not cast out into the cytoplasm, as Moore and Robinson state, but passes into half the spermatozoa. There is, however, a plasmosome which stains with many chromatin dyes that is extruded from the nucleus.

A side by side conjugation (parasynapsis of Wilson) of the chromatin threads during synizesis probably occurs. Two longitudinal divisions of the chromosomes thus formed, take place in the two spermatocytes. Synizesis is not an artefact, but is a process bearing definite relations to the behaviour of the centrosomes.

Rabl's theory of individuality and Boveri's "Grundgesetz der Zahlenkonstanz" are true as far as the persistence of the odd chromosome, from the beginning of the first spermatocyte stages, through to the formation of the spermatozoon, affords evidence.

* Cornell Univ. College Agric., Bull. 265 (1909) pp. 367-88 (2 pls. and 27 figs.).

† Revue Russe d'Entom., viii. (1908) pp. 87-8. See also Zool. Zentralbl., xvi. (1909) p. 613.

‡ Centralbl. Bakt. Parasitenk., lii. (1909) pp. 243-8 (1 pl.).

§ Arch. Zool. Exper., ii. (1909) Notes et Revue, No. 1, pp. xvii.-xix.

|| Arch. f. Zellforsch., iii. (1909) pp. 483-520 (2 pls. and 1 fig.).

Spermatogenesis in *Stenobothrus biguttulus*.* — Pol Gérard describes the spermatogenesis in this small Acridiid. A testicular tube shows the following zones: of spermatogonia, growth, maturation-division, spermatids, and of spermatozoa. These zones are described in detail. We cannot do more, however, than refer to the author's twenty-six general conclusions. A very important point, corroboratory of other work, is that half of the spermatocytes of the second order have nine chromosomes and half have eight. So in the spermatids, half have a heterotropic chromosome which the others lack.

New Phorid.† — Ivar Trägårdh describes the female of *Cryptoptomyia jeanssoni* g. et sp. n. from Pietermaritzburg. There are three ocelli; the compound eyes have only fourteen facets; the clypeus is as in *Puliciphora*, that is not very large; the antennæ are 6-jointed, of the Phorid type; the thorax is square, with short pyriform vestiges of wings. The new genus is referred to a position between entirely wingless forms (*Puliciphora*, *Chonocephalus*, and *Wandolleckia*), and *Ecitomyia* and *Xanionotum*, which have reduced vestiges of wings. The author points out that *Thaumatoxena andreinii* and *Th. wasmanni* are hardly separable, and that Enderlein's genus *Termitodeipnus* must be included in *Thaumatoxena*.

New Primitive Insect.‡ — A. Schepotieff describes *Protopteron indicum* g. et sp. n. from the Malabar coast, one of the Thysanura, nearest *Acerentomon* and *Campodea*. The chitinous cuticle is weak; there is no sharp distinction between thorax and abdomen; there are twelve abdominal segments, the first four with appendages; there are no wings, cerci, or special copulatory parts; the mouth-parts are entognathus and suctorial; there are six Malpighian vessels; the gut is straight; the tracheal system is without anastomoses and spiral fibres; there are two stigmata; the nervous system consists of supra-oesophageal and sub-oesophageal ganglia, and a ventral chain of eleven ganglia; the genital apertures are paired.

Schepotieff divides the Thysanura in the following way, regarding *Protopteron* as most primitive of all:—

Thysanura	{	Euthysanura	{	Lepismatidæ.
				Gastrothecoidea.
				Machiloidea.
		Dicellura ...	{	Japygidæ.
				Projapygidæ.
		Prothysanura	{	<i>Campodea</i> .
				<i>Acerentomon</i> .
				<i>Protopteron</i> .

In many respects this new primitive type approaches the Myriopods, notably *Scolopendrella*.

* Arch. Biol., xxiv. (1909) pp. 543-625 (3 pls. and 11 figs.).

† Zool. Jahrb., xxviii. (1909) pp. 329-47 (1 pl. and 16 figs.).

‡ Tom. cit., pp. 121-38 (3 pls.).

Pests of the Hop.*—F. W. Theobald discusses the hop aphid (*Phorodon humuli*), earwigs, a spring-tail (*Entomobrya nivalis*), the hop red spider (*Tetranychus altheae*), millipedes, and eelworms.

Monograph on Myrientomata.†—A. Berlese establishes an order of Myrientomata for certain primitive genera—*Acerentomon* Silv., *Acerentulus* Berl., and *Eosentomon* Berl. The first two genera, which form the family Acerentomidae, are destitute of tracheae or stigmata. This order of primitive forms presents most affinity with the Pauropod Myriopoda. Berlese gives a detailed monographic account.

7. Myriopoda.

New Scutigera.‡—A. D. Imms describes *Scutigera subunguiculata* sp. n. from the Himalayas. It is closely allied to *S. unguiculata*. This is the second record of the Symphyla from India. On account of the phylogenetic importance of Symphyla among Myriopods the discovery of an isolated new species has more than average interest.

8. Arachnida.

Structure and Development of Mites.§—Enzio Reuter has made a detailed study of *Pediculopsis graminum*, and has used this as a basis for a general treatment of the structure and development of Acarids. We have indeed a very important monograph on mites, to which we must direct the attention of specialists. His discussion of the epimorphosis (not metamorphosis) is very valuable. He proposes a new system of sub-orders—Gamasiformes, Trombidiformes, Sarcoptiformes and Eriophyiformes. He finds the nearest affinities of Acarina in Pedipalpi (Uropygi).

Swiss Tardigrada.||—J. Ammann gives a short account of *Macrobotus polychætus* sp. n., and discusses the occurrence of other Tardigrada in Switzerland. He has found nine species of *Macrobotus* and three of *Echiniscus*.

9. Crustacea.

Minute Structure of Respiratory Organs in Crustaceans.¶—A. Bernecker has made a comparative histological study of the respiratory structures in *Branchipus*, *Apus*, *Daphnia*, *Cyclops*, *Gammarus*, *Phronima*, *Asellus*, *Oniscus*, *Porcellio*, *Astacus*, *Pagurus*, *Argulus*, *Limulus*, and some other forms.

Phylogeny of Atyidae.**—E. L. Bouvier shows the nature of the steps which may have led to the evolution of the Atyidae from the Acanthephyridae. The primitive family Acanthephyridae is now abyssal, but there were formerly littoral representatives, which became adapted to fresh-water conditions.

* Journ. Board of Agriculture, xvi. (1909) pp. 617-28 (3 pls.).

† Redia, vi. (1909) pp. 1-182 (17 pls. and 14 figs.).

‡ Journ. Linn. Soc., Zool., xxx. (1909) pp. 252-5 (1 pl.).

§ Acta Soc. Sci. Fennicæ, xxxvi. (1909) pp. 1-287 (6 pls.).

|| MT. Naturf. Ges. Bern, 1909, pp. 1-15 (2 figs.)

¶ Zool. Jahrb., xxvii. (1909) pp. 513-630 (4 pls. and 1 fig.).

** Comptes Rendus, cxlviii. (1909) pp. 1727-31.

New Amphipods from Eastern Tropical Pacific.*—A. Woltreck describes a number of interesting forms, e.g. *Chuneola paruloxa* g. et sp. n., *Mimonecteola diomeleæ* g. et sp. n., and *Microphasma agassizi* g. et sp. n. He also discusses the "reflector-organs" of *Scypholanceola*, which he regards as adaptations to reflect the luminosity of other creatures or faint gleams from above.

Terrestrial Species of Talitrus from Victoria.†—O. A. Sayce describes *T. kershawi* sp. n., and gives a fuller description than heretofore of *T. sylvestris*, which ranges from the seaboard to the tops of the highest mountains. The two species are often together.

New Species of Leperditia.‡—Frederick Chapman describes a new Ostracod, *Leperditia shearsbii* sp. n., in shaly micaceous mudstone (Silurian) from Yass, New South Wales, the first species of this genus to be described for Australia.

Double Nauplius.§—E. Chatton describes a thoroughly double nauplius in *Ophioseides joubini*, parasite of *Microcosmus sabatieri*, a rare occurrence among Crustaceans. Double embryos of the lobster have been described.

Notes on Rhizocephala.||—Max Kollmann found *Parthenopea* on *Galathea dispersa*, and notes that in the nauplius there is a closed median endodermic vesicle. There is usually no trace of endoderm in the nauplius of Rhizocephala.

Kollmann also found *Lenæodiscus galathææ* on *Galathea intermedia*, and points out that it has little influence on its host.

He calls attention to cases of several specimens of *Succulina* on one crab, and from the way in which the roots unite in one system the author concludes that there is a sort of "polyembryony," one embryo giving rise to several "individuals."

Generation-cycles in Cladocera.¶—L. Keilhack maintains that the maximum number of parthenogenetic generations is hereditarily determined for each species. The external conditions, which are never quite uniform, supply the stimulus to the onset of the sexual period, and may do so before the normal time. In artificial conditions with uniformity of temperature and nutrition, pathological phenomena set in after the normal maximum of parthenogenetic generations.

Rudimentary Antennary Gland in Cladocera.**—V. H. Langhans notes that the glands demonstrated by Fischel, by intra-vitam neutral-

* Bull. Mus. Comp. Zool., Harvard, lii. (1909) pp. 145-68 (8 pls.).

† Proc. R. Soc. Victoria, xxii. (1909) pp. 29-34 (2 pls.).

‡ Tom. cit., pp. 1-5 (2 pls.).

§ C.R. Soc. Biol. Paris, lxxvii. (1909) pp. 482-4 (1 fig.).

|| Arch. Zool. Exper., ser. 5, i. (1909) Notes et Revue, No. 2, pp. xliiii.-xlix. (2 figs.).

¶ Internat. Rev. Hydrobiol., ii. (1909) pp. 238-40. See also Zool. Zentralbl., xvi. (1909) pp. 624-5.

** Internat. Rev. Hydrobiol., ii. (1909) pp. 182-5 (1 pl.). See also Zool. Zentralbl., xvi. (1909) p. 626.

red staining, correspond mainly to the terminal saccule of the shell-gland, but that in some cases, e.g. in *Daphnia*, there is a rudiment of the antennary gland.

Annulata.

Eye of *Alciopa cantrainii*.*—R. Demoll gives a detailed account of the structure of the eye, and a discussion of its functioning. Among the many points of interest we may note: (*a*) that there is here the most primitive form of an optic chiasma; (*b*) that there is in the middle of the retina a spot of acutest vision; and (*c*) that the Alciopid optic ganglion should be compared rather to the retinal ganglion of Vertebrates than to the optic thalamus.

Artificial Parthenogenesis in *Aricia*.†—K. Kostanecki has induced parthenogenetic segmentation in the eggs of *Aricia* by subjecting them to acetic acid or nitric acid solutions, with subsequent transference to hypertonic solutions. Only a few of the ova segmented, and few got beyond three or four cells. In some cases six and eight cells were formed. The nuclear phenomena were carefully observed.

Peruvian Polychæts.‡—Ch. Gravier gives an account of a collection made by Dr. Rivet at Payta on the Peruvian coast. Of the nineteen species nine are new. Some of the extensions of distribution are striking: thus *Stylaroides (Trophonia) capensis* McIntosh previously reported from the Cape and from the Red Sea, is now recorded from Ceylon.

Disease in *Arenicola*.§—H. B. Fantham and Annie Porter note that few pathogenic bacteria have been described from the digestive tract of Invertebrates, and that it is, therefore, of interest to record *Bacillus arenicolæ* sp. n. from the lumen of the gut and within the intestinal epithelium of *Arenicola ecaulata*. The bacillus causes lesions in the gut-epithelium, and may hasten the death of the Annelid.

Blood-vessels of Australian Earthworms.||—Gwynneth Buchanan has studied nineteen species of *Megascolides*, *Megascolex*, *Diporochæta*, *Perichæta*, etc. The number of hearts seems to be fairly constant, three being the usual; they may be always distinguished from mere swollen vessels by their connection with the supra-intestinal (except in *Diporochæta divallia*); their function is mainly propelling. There is no evidence in Australian forms of the existence of a subneural vessel. The ventral blood-vessel is always single; the dorsal is usually single. The blood supply to the alimentary canal and related structures at the anterior end is generally more or less in the form of a plexus. These are a few of the points in this paper.

Musculature of Hirudinea.¶—Louis des Arts has studied numerous types. The element is the nuicellular muscle-fibre, which has a con-

* Zool. Jahrb., xxvii. (1909) pp. 651-86 (1 pl. and 4 figs.).

† Bull. Int. Acad. Sci. Cracovie, 1909, pp. 238-53 (16 figs.).

‡ Arch. Zool. Expér., x. (1909) pp. 617-59 (3 pls.).

§ Centralbl. Bakt. Parasitenk., lii. (1909) pp. 329-34 (1 pl.).

|| Proc. R. Soc. Victoria, xxii. (1909) pp. 59-84 (4 pls.).

¶ Jenaische Zeitschr. f. Naturw., xliv. (1909) pp. 415-66 (3 pls.).

tractile cortex and an internal protoplasmic substance with the nucleus. The cortex consists of fibrils and interfibrillar substance, and the fibrils consist of finer fibrils. Usually the shape is fusiform, but there are various departures from the type. Muscle-bridges occur especially in the intestinal musculature. Many interesting details are recorded; thus in the muscle-cells of the dorsal blood-vessel of *Pontobdella*, the contractile cortex shows circular striping externally, while the internal striping runs in the longitudinal direction of the blood-vessel.

Sagitta enflata.*—Paul Hallez discusses the characters of a species of *Sagitta* common at Portel, which he refers to *S. enflata* Grassi, though it has a smaller and more slender body, with never more than five anterior teeth, and with the ventral ganglion nearer the anterior fin.

Nematohelminthes.

Studies on Nematodes.†—O. von Linstow describes *Hedruris squamata* sp. n. from the stomach and intestine of the Chelonian, *Clemmys guttata*.

New Nematodes.‡—O. von Linstow describes the following new species from German S.W. Africa: *Heterakis schebeni*, from the intestine of *Cynictis penicillata*; *H. poculum*, from the francolin; *Physaloptera brevicaula*, from the same; and *Oxyuris polygon*, from *Xerus setosus*.

Ascaris mystax in Lion.§—G. Vallillo reports the abundant occurrence of this species in the mucous membrane of the stomach and intestine of a lion. Only one previous case has been recorded (Linton).

Structure and Life-history of Rhabditis brassicæ.||—Rowland Southern describes this new species of Nematode from a rotten turnip. The two sexes were found in approximately equal numbers, but the "females" are really self-fertilising, protandrous hermaphrodites. The species may be in process of transition to a dicecious condition. All stages between oviparity and viviparity occur, but the latter is rare. The evidence goes to show that *Rhabditis brassicæ* does not originate disease, though they quickly destroy the turnips if they get into the soft tissues through an injury to the epidermis.

Trichinosis in Posen.¶—Otto Busse found in Posen that in 96 bodies of people over sixty, no fewer than 18 showed encapsuled Trichinæ—that is, about every fifth. He shows in an interesting indirect way that the parasites may remain living within their capsules for more than forty years.

Microfilariae of Fowl.**—C. Mathis and M. Léger find that in the fowls at Tonkin there is an abundance not only of *Microfilaria mansoni*, but also of another species which they record as *M. sequini* sp. n.

* Arch. Zool. Expér., ii. (1909) Notes et Revue, No. 2, pp. xxix.-xxxiii. (5 figs.).

† Arch. Naturges. lxxv. (1909) pp. 63-6.

‡ Centralbl. Bakt. Parasitenk., l. (1909) pp. 448-51 (4 figs.).

§ Op. cit., li. (1909) pp. 461-2.

|| Journ. Econ. Biol., iv. (1909) pp. 91-5 (1 pl.).

¶ Centralbl. Bakt. Parasitenk., lii. (1909) pp. 368-77.

** C.R. Soc. Biol. Paris, lxxvii. (1909) pp. 407-9 (1 fig.).

Two Filariæ in Snake's Blood.*—F. d'Herelle and H. Seidelin describe from the blood of *Bou imperatoris* from Yucatan a new microfilaria, named as *Filaria imperatoris* sp. n., and from another snake (*Leptophis mexicanus*) another new species, named as *F. kilinchei*.

Larva of Echinorhynchus in Tench.†—J. K. Riquier found encapsuled larvæ of *Pomphorhynchus lævis* Zoega (= *Echinorhynchus proteus* Westr.) in the liver, intestinal wall, and peritoneum of *Tinca vulgaris*. They are also known from minnow, stickleback, etc. When transferred to pike the larvæ grew into mature forms in sixty-five days, and attained their maximum size in about three months.

Platyhelminthes.

New Species of Davainea.‡—O. von Linstow describes *D. provincialis* sp. n. from *Francolinus alpersus* from German S.W. Africa, and has some notes on *Davainea* in general. The genus is readily distinguished, for there is no rostellum, and the apex shows two closely adjacent rings of very minute and very numerous hammer-shaped hooks.

Excretory System in Triclad.§—Al. Mrázek has found in *Planaria vitta*, *Dendrocaelum lacteum*, *Polyclis nigra*, and other forms, convincing evidence that there is a richly branched system of excretory vessels in the pharynx.

New Trematode from Man ||—E. Rodenwaldt describes *Fasciolopsis füllebornii* sp. n. from an Indian. Three specimens were passed. The generic diagnosis of this type of fluke is as follows:—Large Fasciolinæ with smooth unarmed skin and tongue-like shape; large digitate testes one behind the other; the two divisions of the gut are unbranched; the ovary is small, finely branched, and lies along with the shell-gland about the middle of the body; there is a relatively large cirrus-pouch. Four species are known. Attention must be directed to the exceedingly fine coloured plate.

Incertæ Sedis.

Polyzoa of Madeira.¶—A. M. Norman gives a list of 139 species of Polyzoa from Madeira and neighbouring islands. He has himself found 114 of the 139, and has added 39 to those previously recorded for this region.

Echinoderma.

Teeth and a Lantern in Echinoneus.**—Alexander Agassiz calls attention to the interesting discovery (by M. Westergren) of the presence of teeth and a fully-developed lantern in young specimens (3, 7, and 4.25 mm. in length) of the West Indian *Echinoneus semilunaris*. "This is perhaps one of the most interesting recent discoveries in the

* C.R. Soc. Biol. Paris, lxvii. (1909) pp. 409-11 (1 fig.).

† Centralbl. Bakt. Parasitenk., lii. (1909) pp. 248-52 (3 figs.).

‡ Tom. cit., pp. 75-7 (2 figs.).

§ Zeitschr. wiss. Zool., xciii. (1909) pp. 64-72 (5 figs.).

|| Centralbl. Bakt. Parasitenk., l. (1909) pp. 451-61 (1 pl. and 3 figs.).

¶ Journ. Linn. Soc. (Zool.), xxx. (1909) pp. 275-314 (10 pls.).

** Amer. Journ. Sci., xxviii. (1909) pp. 490-2 (1 pl.).

domain of echinology, considering the relationship hitherto recognised of *Echinoneus* to the Atelostomata." The presence of teeth would transfer the genus to the vicinity of such types of the exocyclic Gnathostomata as *Holcetypus*, *Discoidea*, *Pygaster* (Echinoconidæ), and more remotely to the Conoclypidæ. "The demonstration of this interesting relationship would be interesting in itself, but its great importance lies in the fact of the disappearance of the masticatory apparatus at a very early age. Young specimens of *Echinoneus* measuring 5.1 mm. in length, and but slightly larger than those on which teeth were observed, have no teeth or lantern, and nothing is left of them but the presence of small auricles, so that in the older and adult stages of *Echinoneus* its relationship to the Spatangoids is in no way modified."

Luminosity of Ophiuroids*—Iwan Sokolow has studied this in a number of northern species—*Ophiacantha bidentata* Retzius, *Ophioscolex glacialis* Müller and Troschel, *Ophiura sarsi* Lütken and *Ophiopholis aculeata* L.

The luminescence is not spontaneous, but is induced by mechanical, chemical, thermal and other stimuli. It is intra-cellular, no luminous secretion being produced. It is seen on the spines and on the plates of the arms, especially on the lateral plates. As separated arms and even spines may be luminous, it is evident that the central nervous system is not indispensable. The basis of the luminosity seems to be a fluid substance, which, on treatment with fresh water, may diffuse out over the whole arm from specially luminous points. There is no luminosity after death. Microscopic examination reveals the presence of numerous glandular cells with granular contents and also homogeneous fibrous strands, both giving a characteristic brown-violet colouring when treated with thionin. But the meaning of the strands is doubtful.

Systematic Position of Rhabdomolgus Novæ-Zelandiæ.†—S. Becher discusses this species, which Dendy and Hindle established in 1907, and gives many reasons for separating it off from *Rhabdomolgus*, and establishing for it a new genus which he calls *Kolostoneura*, in reference to the great reduction of the radial nerves.

Coelentera.

Movements and Sensory Reactions of Veretillum cynomorium.‡ Georges Bohn describes the behaviour of this colony (Pennatulacea), which passes from complete relaxation to turgidity and from insensibility to exquisite sensitiveness. The chemical equilibrium of a cell which has been expanded is destroyed; the return to equilibrium shows two successive phases, the first of "sensibilisation," the second of "desensibilisation."

Development of Lucernarids.§—W. Wietrzykowski finds that a planula emerges from the egg and lives freely for a day or two. They

* Biol. Centralbl., xxix. (1909) pp. 637-48 (6 figs.).

† Arch. Zool. Expér., i. ser. 5 (1909), Notes et Revue, No. 2, pp. xxxiii.-xliii. (1 fig.).

‡ C.R. Soc. Biol. Paris, lxxvii. (1909) pp. 484-7 (1 fig.).

§ Comptes Rendus, cxlix. (1909) pp. 746-9.

settle down in crowded groups, combining to capture nauplii. The ectoderm breaks at the apex, the naked endoderm protrudes and begins to work on the dead nauplius. The larva becomes four-lobed and gives off planuliform buds, which also settle down. The larva elongates and forms two tentacles, and then a third and a fourth.

Study of *Cerianthus oligopodus*.*—Paul Cerfontaine gives a detailed account of this species from the Gulf of Naples, which he established in 1891. He proves the occurrence of spontaneous scissiparity. Artificially cut specimens are also capable of regeneration, and the same is true in *C. solitarius*.

Hydroid parasitic on Hydroid.†—Ernest Warren describes *Lafca dispoliens* sp. n., which was found in two cases growing up inside the hydranth of *Sertularia bidens* Bale, replacing the original polyps by its own. It is interesting in many ways. "It exhibits in a striking manner the struggle of the host to squeeze out the parasite and shut it off from its depredations. It also illustrates the economy exercised by the parasite in the secretion of perisarc." For there is practically no perisarc within the shelter, but a substantial one is formed when the parasite passes beyond its host.

Porifera.

Phylogeny of Amphidiscophora.‡—R. Kirkpatrick discusses the relations of the two suborders of the Hexactinellida—namely Amphidiscophora and Hexasterophora, and inquires into the characters of their common ancestor. In an interesting discussion of amphidisks, he points out that the teeth, with all their wonderful developments, have arisen in response to the necessity for keeping the spicule orientated at right angles to the opposing planes of tissue, and of restoring it to its position when displaced. They serve, in fact, as the *points d'appui* for bands of contractile tissue passing from the parallel planes to the teeth. It is suggested that dwellers in earthquake countries might, with advantage, follow the methods adopted by the Amphidiscophoran sponge, for in each case there is the same problem to solve.

Protozoa.

Microzoa in Shales from New South Wales.§—Frederick Chapman describes a number of Foraminifera, and Ostracods, from a hard, grey, calcareous shale; e.g. a Miliolid, *Nubecularia nitida* sp. n., and two Rotalids, *Discorbina cymbuloporoides* sp. n., and *Pulvinulina insignis* sp. n. Two new Ostracods *Beyrichia mesozoica* sp. n., and *Darwinula australis* sp. n., are described.

Hæmoproteus orizivoræ.||—G. Anschütz describes this new species of *Hæmoproteus* from the rice-bird, or padder (*Spermestes orizivora*). It shows two methods of schizogony in unpigmented forms, and also a division of pigmented macrogametes.

* Arch. Biol. xxiv. (1909) pp. 653-707 (1 pl.).

† Ann. Natal Museum, ii. (1909) pp. 105-112 (1 pl. and 2 figs.).

‡ Ann. Nat. Hist., iv. (1909) pp. 479-84 (5 figs.).

§ Rec. Geol. Survey, N.S.W., viii. (1909) pp. 334-8 (1 pl.).

|| Centralbl. Bakt. Parasitenk., li. (1909) pp. 654-9 (2 pls.).

Leucocytozoon from Chinese Partridge.*—M. Léger and C. Mathis describe *Leucocytozoon mesnili* sp. n., an intracellular parasite from the blood of *Francolinus sinensis*. The macrogametes and microgametes are described. There is some resemblance to *Hæmamaeba majoris* from the tit, and to a *Leucocytozoon* from the African francolin.

New Parasitic Amœba in Man.†—M. Koidzumi describes *Entamaeba nipponica* sp. n., found in the intestine of Japanese in advanced cases of amoebic dysentery. He compares it with other species and discusses (1) the binary fission; (2) the schizogony and development of merozoites; and (3) the encystation and chromidium formation.

New Amœba in Man.‡—M. Elmassian describes *Entamaeba minuta* sp. n., associated with *E. coli*, in a patient suffering from dysentery. It shows asexual mitotic division into four, and autogamy followed by sporulation.

Malaria in Birds of Greece.§—Jean P. Cardamatis has made a study of Danilewsky's *Halteridium*, which he has found in fifty-three species of birds in Greece. He examined 936 specimens and found the parasite in 25.64 p.c. The transmission is effected by mosquitos.

Hæmoprotozoa in Birds of New South Wales.||—J. Burton Cleland and T. Harvey Johnston deal with *Halteridium ptilotis* sp. n., from *Ptilotis chrysops*; *H. philemon* sp. n., from *Philemon corniculatus*; *H. geocichlæ* sp. n., from the ground thrush, *Geocichla lunulata*; *H. melioris* from the honey-eater, *Melioris novæ-hollandiæ*. They call attention to the very striking resemblance between spermatozoa of the honey-eaters and spirochæte-trypanosomes.

Symmetry of Embryo Acinetæ.¶—B. Collin discusses the symmetry and orientation of the embryos of *Choanophrya*, *Tokophrya*, *Acineta*, and other forms. There is a constant morphological axis perpendicular to the plane of vibratile cilia. This axis determines a superior or apical pole, corresponding to the oral pole of a discotrichous Infusorian, and very often bearing an oblique row of long cilia (rudimentary adoral zone). The inferior or basal pole shows granular secretions, and sometimes a sucker; this is the point of fixation and of stalk-formation, if there is a stalk. It corresponds to the aboral pole, carrying the "scopula" in the ancestral Vorticellids.

Hypertrophied Acinetæ.**—B. Collin has studied the modifications induced in *Tokophrya* and *Acineta* by over-feeding. These organisms appear to be very suitable subjects for such experimentation, and some interesting phenomena of degenerative growth are described.

* Ann. Inst. Pasteur, xxiii. (1909) pp. 740-3 (1 pl.).

† Centralbl. Bakt. Parasitenk., li. (1909) pp. 650-3 (7 figs.).

‡ Op. cit., lii. (1909) pp. 335-51.

§ Tom. cit., pp. 351-67 (2 pls. and 3 figs.).

|| Journ. R. Soc. N.S.W. xliii. (1909) pp. 75-96 (2 pls. and 2 figs.).

¶ Arch. Zool. Expér., ii. (1909), Notes et Revue, No. 2, pp. xxxiv.-lx.

** Comptes Rendus, exlix. (1909) pp. 742-5.

New Species of Opercularia.*—B. Collin describes *Opercularia faurei* sp. n., which he found on the water-beetle *Hydrophilus piceus*. The interesting retractile apparatus is homologous with the contractile cord in *Vorticella* and *Carchesium*. There is a muscular bundle formed by the convergence of basal myonemes, a more or less differentiated plasmic axis, and an integumentary investment. But in *Vorticella* an elongation of the aboral pole is continued within the stalk, whereas in *Opercularia* an elongation of the body is inserted on the top of the stalk.

Pathogenic Role of Balantidium coli.†—E. Brumpt submits experimental evidence showing that this well known parasite of man (causing dysentery or colitis) is pathogenic in monkeys (*Mucacus cynomolgus*). It may form a white lining along the whole large intestine. The author transferred it from monkey to pig, and from pig to monkey. He observed transverse fission, encystation of single individuals, and encystation of two conjugating individuals.

Symbiosis exhibited by a Ciliated Infusorian.‡—E. Fauré-Fremiet has studied one of the Trichodinidæ, which lives in the intestine of the mollusc *Cyclostoma elegans*. It was described long ago (1858-61) by Claparède and Lachmann, as *Trichodinopsis paradoxa*, and has been recently (1906) studied in detail by R. Issel.

What previous observers have taken to be vibratile cilia, are spirilla living on the surface of the Infusorian. Moreover, the "enigmatical body," described as enveloping the pharynx, is in the pharynx, and consists of bacteria. There is an absolutely constant symbiosis of three organisms: an ecto-parasitic spirillum, an internal symbiotic bacterium, and the Ciliate. The author notes that the genus *Trichodinopsis* must be suppressed in favour of *Trichodina*.

Tentacle-like Processes on Opalina dimidiata.§—M. von Linden describes the occurrence of processes, sometimes as long as the animal itself, on specimens of *Opalina* from the frog. They bore a fringe of fine cilia; they were sometimes forked; they persisted for at least 18 hours. Are they atypic locomotor structures, or pathological altogether, or have they to do with division? The observer inclines to the third view.

New Parasites of Dendrocœlum.||—E. André describes *Ophryoglena parasitica* sp. n., an Infusorian living in the gut of the Planarian *Dendrocœlum lacteum*. It differs very slightly from the free-living species of the genus, and shows little traces of the effects of parasitism, unless it be in the disappearance of the pharynx.

Trypanosoma lewisi in Rat-louse.¶—E. Rodenwaldt found no Trypanosomes in lice (*Hæmatopinus spinulosus*) which had sucked uninfected rats. He does not believe in *Crithidia hæmatopini* Patton, a supposed parasite of the louse apart from the rat. But lice which

* Arch. Zool. Expér., ii. (1909), Notes et Revue, No. 2, pp. xxi.-xxix. (2 figs.).

† C.R. Soc. Biol. Paris, lxxvii. (1909) pp. 103-5.

‡ Tom. cit., pp. 113-4.

§ Biol. Centralbl., xxix. (1909) pp. 648-50 (11 figs.).

|| Revue Suisse Zool., xvii. (1909) pp. 273-80 (3 figs.).

¶ Centralbl. Bakt. Parasitenk., lii. (1909) pp. 30-42 (3 pls.).

suck infected rats soon show *Crithidia*-like and *Leptomonas*-like forms—stages of *Trypanosoma lewisi*.

Studies in Trypanosomes.—David Bruce, A. E. Hamerton, H. R. Bateman, and F. P. Mackie* describe *Trypanosoma ingens* sp. n. from reed-buck, bush-buck, and ox in Uganda. In stained preparations this huge Trypanosome may measure as much as 122 microns. When alive it moves slowly and deliberately across the field of the Microscope, with a fine rippling, or at times a broader undulating movement.

C. H. Martin and Muriel Robertson† found in the intestine of the fowl a form which they identify with that described by Eberth as *Trypanosoma eberthi* (= *Spirochaeta eberthi* Lühe). Along with it there was a *Trichomonas*-like form and a *Monocercomonas*-like form. All three may be phases of one life-cycle.

C. Mathis and M. Léger‡ describe *Trypanosoma cabnettei* sp. n. from Toukin fowls, in which it is of rare occurrence, and apparently without pathogenic importance.

New Trypanosome.§—Jivoïn Georgewitch describes *Crithidia similæ* sp. n. from a specimen of the fly, *Simulium columbacensis*, in Servia.

Chytridiopsis.||—L. Léger and O. Duboscq report four new species allied to Schneider's *Chytridiopsis socius*. They occur in the intestinal epithelium of Arthropods. Their affinities remain obscure, but it is suggested that they are microsporidia of minute size with spherical spores.

Two New Parasites from Tench.¶—M. Elmassian describes *Coccidium rouxi* sp. n.—its schizogony, macrogametes and microgametes, conjugation, sporonts, cysts and sporocysts. Each cyst has four sporocysts, and each sporocyst two sporozoites—one of the features of the genus *Coccidium* (*Eimeria*). Another very different parasite occurred along with the Coccidian in the middle intestine, and in some cases profoundly modified the Coccidian. This second parasite is described as *Zoomyxa legeri* g. et sp. n. There are four different modes of schizogony and there is a sexual process. The systematic position of *Zoomyxa* is obscure. In some ways it resembles *Chytridiopsis*, in other ways it suggests a derivation from the lower Mycetozoa.

New Spirochaet from Fresh-water.**—K. Nägler describes *Spirochaeta flexibilis* sp. n., which he found in foul mud. There is no undulatory membrane, but there is a characteristic ectoplasmic "periplast fibril" twisted in a close spiral. This new form is nearest other free-living species, such as *S. plicatilis* Ehrenberg, *S. balbiani* Certes, *S. anadontæ* Keysselitz, and *S. pinnæ* Gonder.

* Proc. Roy. Soc., Series B, lxxxi., No. B 549, pp. 323-4 (1 pl.).

† Tom. cit., pp. 385-91 (1 pl.).

‡ C.R. Soc. Biol. Paris, lxxvii. (1909) pp. 452-4 (1 fig.).

§ Tom. cit., pp. 480-2 (1 fig.).

|| Arch. Zool. Expér., i., Series 5 (1909) pp. ix.-xiii. (2 figs.).

¶ Op. cit., ii. (1909) pp. 229-70 (2 pls.).

** Centralbl. Bakt. Parasitenk., l. (1909) pp. 445-7 (1 pl.).

BOTANY.

GENERAL,

Including the Anatomy and Physiology of Seed Plants.

Cytology,

including Cell-Contents.

Chromosomes in *Oenothera*.*—R. R. Gates has crossed *Oenothera lutea* with *O. gigas* and finds 21 chromosomes in the somatic cells, 7 of which are of maternal origin and the remainder of paternal origin. At the time of reduction the chromosomes segregate, half the germ-cells receiving 10 chromosomes and the other half 11 chromosomes, but sometimes the distribution is irregular, and this irregularity accounts for a variation in the number of chromosomes in the individuals of a race. The segregation of chromosomes in the germ-cells of the hybrid proves that there is no pairing and separation of homologous chromosomes, but separation into numerically equal groups. It seems that there are two general methods of reduction in plants, viz. a side-by-side pairing of chromatin threads to form a double spirem, and an end-to-end arrangement to form one single spirem which afterwards splits longitudinally. The behaviour of the chromosomes in *Oenothera* favours the view of their continuity from generation to generation. If it can be proved that the chromosomes of *Oenothera* are "of unequal hereditary value," the author believes that it would be possible to account for the mutations in *O. Lamarckiana*.

Mitosis in *Synchytrium*.†—In previous papers R. F. Griggs showed that the nuclei of *Synchytrium* were derived very largely by amitosis; the present paper describes the mitoses which follow and their correlation with the amitoses. As in cœnocytes generally he found that all the nuclei in a cyst pass into mitosis simultaneously. In the resting nuclei the chromatin is concentrated in a globular mass, the karyosome; the spirem is formed from the compact karyosome and differs in several respects from the amitotic spirem, though often they are indistinguishable; the spindle seems to be differentiated from a spirem strand; some of them show nucleoli lying in the nuclear cavity beside the spindle, in others no nucleolus is present; there are no centrosomes; asters are formed at the poles and form the nuclear membrane. There are constantly four chromosomes, and the author discusses at great length the nature of these; he concludes that there is no morphological continuity in the chromosomes, and that the nucleus rather than the chromosome is the morphological unit.

* Bot. Gaz., xlviii. (1909) pp. 179-99 (3 pls.).

† Tom. cit., pp. 339-58 (3 pls.).

Study of Chitin.*—D. H. Wester finds that chitin, as found in animals and plants, is identical: it never gives albumen-reaction, and is not coloured by iodine solution. Chitin is not digestible, and as much of the estimated nitrogenous substance of fungi is chitin, the nutritive value of fungi is seriously called in question.

Wester's work was largely taken up with the localisation of chitin in animals and plants. It is of frequent occurrence in fungi: *Mucor* and *Phycomyces nitens* have considerable quantities in their cell-walls, but no cellulose; the spores of *Peziza aurantia* show more of it, while in the fungus itself it is abundant. Results were very varied in lichens, according to the species examined; age also was a factor in the case: the author considers that the symbiotic conditions probably affect the quantity of chitins. Complications were also caused by the presence of lichenin. None of the substance was detected in Cyanophyceæ or in Myxomycetes, except in the spores of *Plasmodiophora Brassicæ*. Bacteria were free from chitins, as were all the other plants examined.

Structure and Development.

Vegetative.

Wood Structure in Pineæ.†—I. W. Bailey has investigated the structure of wood in the Pineæ, and the following appear to be the most notable features. In *Picea* the wood-parenchyma occurs in the outer parts of the summer wood, and in a few instances is strongly developed. It is only poorly developed in *Larix* and *Pseudotsuga*. In all three genera septate tracheids occur which clearly show the transition from wood-parenchyma. In *Pinus* similar tracheids occur, but wood-parenchyma is rare. There are spiral thickenings of the tracheids in the spring and summer wood of *Picea* and *Pseudotsuga*, and they are also found in *Pinus*. Such thickenings also occur in the marginal tracheids, and those interspersed in the medullary rays of *Picea*, *Larix*, and *Pseudotsuga*. *Pinus* appears to be distinct from other modern Pineæ, but the nut and foxtail pines have certain details in the structure of their wood which resemble the structure of the wood in *Picea*, *Larix*, and *Pseudotsuga*. The author concludes "that the identification of woods and fossils of *Picea*, *Larix*, and *Pseudotsuga* is an extremely difficult undertaking."

Wild and Cultivated Dioscorea in Tropical Africa.‡—A. Chevalier contributes a note upon the yams of tropical West Africa. In the virgin forests, near the sources of the Niger and Chari, the author has observed large quantities of a wild plant which he regards as an undoubted spontaneous species of *Dioscorea prehensilis*. In the neighbourhood of Baoute and the Ivory Coast thirty races of yams are cultivated for food and medicinal purposes, and these are all included under the three species *D. latifolia*, *D. alata*, and *D. prehensilis*. These races are distinguishable by the gradation and frequency of the spines on the stem, the ramification and length of the branches, and the colour, size, and form of the leaves. The most distinguishing charac-

* Arch. Pharm., cexlvii. (1909) pp. 282-307. See also Bot. Zeit., lxxvii. (1909) pp. 293-4.

† Bot. Gaz., xlviii. (1909) pp. 47-55 (1 pl.).

‡ Comptes Rendus, cxlix. (1909) pp. 610-12.

teristic, however, is the variation in the size, form, etc., of the tubercles. An interesting biological difference between the wild and cultivated forms of *D. preheusilis* is the presence in the former of a thick bush of spiny rhizomes at the summit of each tubercle. These rhizomes grow round the tubercle below the soil and sometimes protrude beyond the surface. Such rhizomes do not occur in the cultivated forms.

Studies on Roots.*—H. von Alten has studied the root structure of various herbaceous and woody Dicotyledons, and finds that in the former the old roots are successively replaced by younger ones, but that the differences in structure found in old and young roots are due to difference in age, and not, as stated by Tschirch and others, to difference of function. Both nourishing and attaching roots have the same structure at the same age. On the other hand, the roots of woody Dicotyledons show a difference in structure consequent upon difference in function. The lower part of the main root and its attached roots are at first similar to those of herbaceous plants, but later on two distinct kinds of roots are to be noticed, viz., attaching roots and nourishing roots. The author considers that herbaceous plants have typically dimorphic roots, while heterorhizy is characteristic of woody plants. The present paper concludes with some general remarks upon the structure of the central cylinder in the two kinds of roots, the number of protoxylems, and the formation of hypodermis, cork, and endodermis.

Studies in *Æginetia*.†—S. Kusano publishes an account of his studies of the embryology of *Æginetia indica*, and the results obtained tend to throw light upon our present knowledge of phanerogamic parasites. *Æginetia* shows transitional states between autophytic and advanced parasitic life, and the chief results of the author's observations are as follows:—The seed will only germinate under the stimulus of the host-root, the stimulus being due to some substance excreted and diffused throughout the soil. After being kept dry for two years the seed loses its power of germination. The host-plant may be a Vascular Cryptogam, Gymnosperm or Angiosperm, and the stimulant excreted is probably common to all the higher plants. Although all roots can stimulate the germination, the seedlings will only develop upon certain natural hosts. The first stage of germination is the transformation of the epidermal cells at the radical end of the embryo into hair-tendrils, and no further development takes place until attachment to the host is effected. When this is accomplished, spherical tubercles arise in the neighbourhood of the tendrils, owing to some stimulant provided by the host. Some tubercles are differentiated into a primary haustorium, and the remainder into root and shoot.

Reproductive.

Gametophytes and Fertilisation in *Juniperus*.‡—A. M. Ottley has studied the development of *Juniperus communis* and *J. virginiana* with the following results. The staminate cones have many sporophylls with microsporangia on their under surface. The female cones have

* Bot. Zeit., lxvii. (1909) pp. 175-98 (2 pls. and 8 figs.).

† Bot. Centralbl., xxiv. (1909) pp. 286-300 (2 pls.).

‡ Bot. Gaz., xlviii. (1909) pp. 31-46 (4 pls.).

three ovules, each subtended by a sporophyll. Soon after pollination the pollen-grain divides into antheridial cell and tube-cell; in *J. communis* the former does not divide until the following April, while in *J. virginiana* it divides in the same year and fertilisation takes place in June or July. The generative cell and the stalk-cell pass into the tube, and the nucleus of the stalk-cell comes to lie near the tube nucleus. When the pollen-tube has reached the archegonia, and just before fertilisation, the generative cell divides to form two similar hemispherical sperm-cells. The macrospore mother-cell appears one year after pollination, and the first mitosis is heterotypic. The female prothallium develops, as in other Gymnosperms, by free cell-formation. The archegonial group arises from superficial cells at the micropylar end of the prothallium, and the group is surrounded by sheath-cells. On the same day that the generative cell divides, the central cell of the archegonium divides, but the ventral canal nucleus disintegrates without forming a separate cell. It appears that *Juniperus* is of more modern origin than many other Gymnosperms.

Ovule, Gametophytes and Embryo of Widdringtonia.*—W. T. Saxton publishes a preliminary account of the life-history of *Widdringtonia cupressoides*, and the chief facts cited are as follows:—The genus *Widdringtonia* is quite distinct from both *Callitris* and *Tetraclinis*. The male gametophyte is the most reduced type known among the Gymnosperms, and no division of the microspore takes place until after pollination. Many megaspores are formed, but only one forms a prothallus, the early development of which is perfectly normal. Over fifty archegonia are formed, and these are arranged in groups upon the upper half of the prothallus, near the margin and on the side down which the pollen-tube grows. Jacket-cells are poorly developed or absent, and the archegonia are apparently without neck-cells. The central nucleus of the archegonium gives rise to the egg nucleus and a ventral nucleus. By karyokinesis the prothallus-cells become binucleate or multinucleate, and this condition is persistent. The haploid number of chromosomes is six and the diploid number twelve. Probably two archegonia are fertilised by two sperms from one pollen-tube. The development of the embryo is normal, and a resemblance to that of *Sequoia sempervirens* is to be noted. The details of development indicate an approach to those of the Gnetales, especially *Tumboa* (*Welwitschia*).

Embryo-sac of Smilacina stellata.†—F. McAllister has studied the embryo-sac of *Smilacina stellata*, and finds that the mother-cell divides to form four nuclei, separated by walls to form four megaspores, but that owing to absorption of these walls, the four nuclei occupy a common cell-cavity. By division eight nuclei are formed, which subsequently organise to form the embryo-sac. Thus four megaspore cells combine to form one embryo-sac or gametophyte. This seems to suggest that in the embryo-sac of the Lilies the first four nuclei are really megaspores.

* Bot. Gaz., xlviii. (1909) pp. 161-78 (1 pl. and 3 figs.).

† Tom. cit., pp. 200-15 (1 pl.).

Embryo-sac of *Habenaria*.*—W. H. Brown has investigated the embryology of *Habenaria ciliaris*, and finds that a single hypodermal cell develops without division into a megaspore mother-cell. The latter gives rise to two daughter-cells, both of which form two megaspores. There is a probability that in some cases more than one megaspore takes part in the formation of the embryo-sac. The latter contains an egg, two synergidæ, two polar nuclei, and three transitory antipodal nuclei. The primary endosperm nucleus results from the fusion of the polar and second male nuclei, but quickly degenerates. There is no evidence in favour of the view that the endosperm is the result of a sexual process. Subsequent to fertilisation a long suspensor and a spherical embryo are formed.

Embryology of the Nympheaceæ.†—M. T. Cook contributes a note upon the development of the Nympheaceæ. The author finds that extra embryo-sacs are frequently formed; the two nuclei resulting from the first division of the endosperm nucleus are separated by an extremely delicate membrane; the endosperm is formed from the nucleus at the micropylar end of the sac; the nucellar tube is subject to great variation; a suspensor may or may not be formed, and varies much in character.

Physiology.

Irritability.

Stimulation of Storage Tissue by Zinc Sulphate.‡—B. Silberberg has investigated the effects produced upon storage tissues by solutions of zinc sulphate. The strength of the solution varied from $\frac{N}{1}$ to $\frac{N}{16}$, and the plants used were *Brassica oleracea*, *Solanum tuberosum* and *Tragopogon porrifolius*, the best results being obtained with *Solanum*. The results of the experiments show that solutions of strength $\frac{N}{12}$ and $\frac{N}{14}$ produce the best results in stimulating the formation of periderm and callus in the meristematic tissues, while solutions of strength $\frac{N}{8}$ to $\frac{N}{1}$ retard the development. It is also found that solutions of strength $\frac{N}{14}$ and stronger solutions inhibit the respiration of storage tissues, while a solution of $\frac{N}{16}$ stimulates the respiration.

General.

Vitality of Pine Seeds.§—W. C. Coker contributes a short paper upon the delayed opening of pine-cones and the vitality of the seeds contained therein. The author draws attention to *Pinus attenuata*,

* Bot. Gaz., xlviii. (1909) pp. 241-50 (12 figs.).

† Tom. cit., pp. 56-60 (1 pl.).

‡ Bull. Torrey Bot. Club, xxxiii. (1909) pp. 489-500 (4 figs.).

§ Amer. Nat., xliii. (1909) pp. 677-81.

P. muricata, *P. contorta*, and *P. chihuahuana*, and refers to the explanation usually given as to the advantage of retention of the seeds until the tree or branch is dead, in places liable to large forest fires. A brief account is then given of experiments performed upon seeds of *P. serotina* in June of the past year. The figures show that even in seeds fourteen years old vitality was often retained; in one experiment 61 such seeds were planted and 21 germinated, while in another experiment 67 seeds were planted and 11 germinated. The author draws attention to the excellent conditions offered by closed cones for the preservation of seeds, e.g. exclusion of spores of bacteria and fungi, maintenance of requisite humidity, etc.

Ferments and Latent Life of Resting Seeds.*—J. White has studied the seeds of wheat, barley, and other cereals, and finds that they contain diastatic, fibrin-digesting and ereptic ferments in appreciable amount. The duration of the power of germination varies much, being only about five years in rye, but eleven to sixteen years in wheat. The ferments retain their activity for a long time after the power of germination has gone, sometimes for twenty years or more. A dry climate favours the longevity of stored seeds. It is not possible to say whether germination can take place in the absence of an enzyme, but no seeds which had lost the power of germination could be made to germinate by the addition of an enzyme, and where the germination was weak the addition of an enzyme seemed to retard germination. Erepsin is more abundant than pepsin, and is more abundant in rye than in any other cereal; it is almost absent in maize. After six hours' exposure to a temperature of 99°–100° C. vitality is destroyed, but the ferments are unaffected. The latter are destroyed by one hour's exposure to a dry heat at 130°–131° C. Diastase is most resistant to heat. Exposure to liquid air may delay germination and decrease the percentage, but does not kill the seeds or affect the ferments. The respiration of carbon-dioxide by seeds stored in air when thoroughly dried, is inhibited when the desiccation is only partial.

New Flora of Krakatau.†—D. H. Campbell gives an interesting description of the new flora of Krakatau. The latter, during the volcanic outbreak of 1883, was covered with lava to the depth of 30 metres. At the suggestion of Treub, the island has been kept under observation since 1886. In that year it was found that the Cyanophyceæ had formed thin black films over the surface of the ashes, and in this substratum several ferns and a few phanerogams had established themselves. In 1897 the island was covered with a characteristic vegetation—e.g. *Ipomœa pes-capræ*, and other strand plants. There were no trees and very few shrubs, but ferns predominated. The latest expedition records that the present flora includes 137 species belonging to all the principal groups. Ferns are no longer predominant, and the forest vegetation is rapidly increasing, but there is a scarcity of Bryophytes. A single specimen of *Cycas circinalis* was found.

* Proc. Roy. Soc., lxxxi. (1909) pp. 417–12.

† Amer. Nat., xliii. (1909) pp. 449–60.

Balls of Vegetable Matter from Sandy Shores.*—W. F. Ganong publishes a further contribution on this subject, and describes the composition of balls from fresh and sea water. The well-known *Posidonia* balls on the shores of the French Riviera were described as long ago as 1879 by Weddell, but their nature had been investigated, though never publicly made known, by the botanists of Antibes. The present author quotes the various literature on the subject, describing the composition of balls of pine-needles, of *Posidonia* with or without algæ and sponge remains, some of *Zostera*, some (in English lakes) of larch-cones, some (in the lakes of the Engadine) of fir-cones and fir-needles, some (in the Lake of Geneva) of wood-shavings. Recently, too, marine balls have been reported from Nova Scotia, composed of algæ—mainly *Dictyosiphon*, *Desmarestia*, *Ectocarpus*, *Chordaria*, and *Chorda*—with some other accessory materials. Again, balls have been recorded from a lake in Michigan composed of tamarack leaves; and, finally, Professor Burrows, of the Michigan Agricultural College, describes balls which consist almost wholly of hair from a tannery located on the shore of Lake Michigan. The wave-formed balls, therefore, occur in the sea as well as the lakes of fresh water, and they are made up of the most diverse materials. The one feature they have in common is their mode of formation, which depends upon the rolling action of the submersed parts of waves working upon fibrous substances resting lightly upon sandy bottoms.

CRYPTOGAMS.

Pteridophyta.

(By A. GEPP, M.A., F.L.S.)

Structure of Fossil and Living Ferns.†—F. Pelourde publishes the results of some comparative researches on the structure of the fossil and living ferns. His conclusions are that the fibrovascular system of the fronds permits four principal types of structure to be distinguished, between which are found transitions often very clear. 1. The first type possesses two woody bundles of *Hippocampus*-form united by their extremities at various levels (*Pteris cretica*, *Nephrodium molle*, etc.). 2. In other cases, at the base of the petiole a certain number of bundles are found arranged in an arc opening upwards, the upper two having a xylem of triangular form with the upper point prolonged by an appendix recurved within (*Aspidium*, *Flicheia esnostensis*). 3. Or again, the petiole encloses a single arcuate bundle open on the upper side (living and fossil *Osmundaceæ*). This arc is sometimes transformed into a closed outer band around a transverse inner band composed of one or more bundles (*Matoniaceæ*, living and fossil *Marattiaceæ*). 4. The vascular system of the frond is composed of a solitary bundle in the form of an arc opening downwards (*Anachoropteris*, certain *Schizæaceæ*).

Anatomy of *Matonia sarmentosa*.‡—R. H. Compton gives an account of the anatomy of *Matonia sarmentosa* based on material

* *Rhodora*, xi. (1909) pp. 149-52.

† *Ann. Sci. Nat. Bot.*, sér. 9, x. (1909) pp. 115-47 (figs.).

‡ *New Phytologist*, viii. (1909) pp. 299-310.

collected in Sarawak by J. Hewitt. He describes the structure of the rhizome, the bifurcation of the rhizome, the anatomy and morphology of the frond, the root, node and protoxylem. He states reasons for rejecting E. B. Copeland's separation of the species from *Matonia* and placing it in a new genus *Phanerosorus*.

Centripetal Xylem in Equisetum.*—A. J. Eames treats of the occurrence of centripetal xylem in *Equisetum*. In summing up his conclusions he states as follows. In *Equisetum* the development of the xylem of the vegetative stem is centrifugal throughout. The internodal bundle does not consist of three united bundles, but is a unit in structure representing the much reduced internodal primary bundle of the Calamites. The axial bundles of the strobilus show conditions intermediate between those in the vegetative stems of the Calamites and of *Equisetum*. The vegetative leaf-trace does not arise solely from the protoxylem-strand of the internodal bundle, but from all three parts of the xylem. The discovery of cauline centripetal wood in *Calamites pettycurensis* Scott affords a link between Equisetales and Sphenophyllales and possibly with the Lycopodiales. Centripetal wood was doubtless well developed in the most primitive Equisetaceous forms, but disappeared early in the history of the series. Yet this ancestral character survives in the leaf-trace. (This conservatism for ancestral characters makes the leaf-trace of great value in questions of phylogeny.) Centripetal wood is now known to exist in all the large groups of Vascular Cryptogams. The formation of xylem adaxially from the protoxylem is a cryptogamic character. Bundles containing both centripetal and centrifugal xylem are not characteristic of any one group of Vascular Cryptogams, as, for example, of the ferns, nor in the higher plants can they be of other phylogenetic value than as indicating general cryptogamic affinities.

Imbedded Antheridia in Dryopteris and Nephrodium.†—C. A. Black gives a résumé of recent papers by Farmer and Digby, by Lang and by Yamanouchi, on apogamy in ferns, and details her own investigations as to the development of the imbedded antheridium in *Dryopteris stipularis* and *Nephrodium molle*. In brief her results are that she found no apogamy in either species, although she repeated the cultural conditions of Yamanouchi. On many of the prothallia she found an imbedded antheridium similar to those of lower ferns. In *D. stipularis* she found in addition some deep-seated structures, half of which consisted of sperms and the remainder of large cells. In *Nephrodium molle* a deep-seated egg- and ventral canal-cell were found.

Prothallium and Embryo of Danæa.‡—D. H. Campbell publishes a preliminary note on the prothallium and embryo of *Danæa*, after studying a fine series of specimens of *D. Jenmani*, *D. elliptica* and *D. jamaicensis*, obtained in Jamaica in July 1908. He briefly indicates the characters of the prothallium, the archegonia and antheridia, and the embryo with its early cell-divisions and rudimentary organs.

* Ann. Bot., xxiii. (1909) pp. 587-601 (pl.).

† Bull. Torrey Bot. Club, xxxvi. (1909) pp. 557-71 (3 pls.).

‡ Ann. Bot., xxiii. (1909) p. 691.

Germination of *Salvinia natans*.*—W. Arnoldi treats of the morphology of the germination of *Salvinia natans*. He describes the germination of the microspore and of the macrospore; the development of the female prothallium; some experiments on the germination of the macrospores. He draws the following conclusion: The prothallium of *Salvinia* is by no means an independent formation, notwithstanding the deceptive presence of chlorophyll in its cells. It is only an organ of the macrospore, as in *Marsilia*, and even *Selaginella* and *Isoetes*, which serves only to bear the archegonia, and is incapable of nourishing the growing spore-bearing generation.

***Botrychium ternatum* and its Allies.**†—R. C. Benedict publishes the third of his studies in the Ophioglossaceæ—namely, a key to those species or forms of *Botrychium* which belong to the group *B. ternatum*, the characters of which are as follows: Bud hairy, common stalk hypogean, short, usually less than one-quarter the height of the plant; spores maturing from July to October. This represents the genus *Sceptridium* of Lyon. The group is composed of thirteen members.

New Species of *Lycopodium*.‡—W. Herter publishes some additions to his recent monograph § of *Urostachys*, a sub-genus of *Lycopodium*. He gives descriptions of seven new species, and indicates the position which they should occupy in the monograph cited.

North American Fern-flora.||—L. M. Underwood, R. C. Benedict, and W. R. Maxon, contribute the first sections of the fern volume of the North American Flora—namely, the families Ophioglossaceæ (three genera—*Botrychium*, *Ophioglossum*, *Cheiroglossa*); Marattiaceæ (*Danæa*, *Marattia*); Osmundaceæ; Ceratopteridaceæ; Schizæaceæ (*Lygodium*, *Actinostachys*, *Schizæa*, *Lophidium*, *Anemia*); Gleicheniaceæ (*Dicranopteris*); Cyatheaceæ (*Cyathea*); six other genera to be published hereafter). English descriptions are given, and careful keys to genera and species.

North American Ferns.—W. A. Poyser ¶ gives an account of the fern-flora of Pennsylvania, with some introductory remarks upon the physical geography of the State. He enumerates 101 species and varieties. W. C. Coker ** gives an account of *Lycopodium adpressum* f. *polyclavatum*, discusses its peculiarities, and argues in favour of the specific difference between *L. adpressum* and *L. alopecuroides*. W. N. Clute, on the other hand, contends that *L. adpressum* is a mere ecological form of *L. alopecuroides*. A. Prescott †† gives some simple rules for the pronunciation of fern names. W. N. Clute ‡‡ discusses and figures *Asplenium ebeneum* f. *furcatum*, a new forked form of the Ebony fern. D. L. Dutton §§ describes *Osmunda cinnamomea* f. *augusta*, a new form. E. W. Vickers ||| calls attention to the sparse distribution of *Asplenium*

* Flora, c. (1909) pp. 121-39 (figs.).

† Torrey, ix. (1909) pp. 197-200.

‡ Hedwigia, xlix. (1909) pp. 88-92 (pl.).

§ Engler's Bot. Jahrb. Beibl. 93.

|| New York Bot. Gard., xvi. pt. 1 (1909) pp. 1-88.

¶ Fern Bulletin, xvii. (1909) pp. 65-83. †

** Tom. cit., pp. 83-5 (pl.).

†† Tom. cit., pp. 86-7.

‡‡ Tom. cit., pp. 88-9 (fig.).

§§ Tom. cit., pp. 89-90.

||| Tom. cit., pp. 97-99.

montanum in Ohio, and describes a new station—namely, a remarkable rock, in the Mahoning River. A. Prescott* writes of the Grape ferns (*Botrychium*), and briefly sketches the morphology and habitat of *B. obliquum* and its varieties. F. J. A. Morris,† writing from Port Hope, Ontario, shows how little foundation there is for the common impression that *Ophioglossum vulgatum* is rare and local. If sought for in suitable places the species is abundant, especially in upland meadows, and is often associated with *Nephrodium thelypteris*. E. J. Winslow‡ records the occurrence of *Botrychium lanceolatum* in Vermont at an elevation of 1500 feet, and almost on the Canadian frontier. O. E. Jennings§ records a new locality, near Kinkiang in Central China, for *Hymenophyllum denticulatum*, and sketches its distribution as previously known—namely, the Indo-Malayan region. W. N. Clute|| gives further particulars and figures of *Polystichum acrostichoides* f. *multifidum*. He also supplies a résumé of E. B. Copeland's observations on humus-collecting and myrmecophilous ferns in the Philippines; and a biographical notice of Thomas Minot Peters, a senator and judge in Alabama, a botanical colleague of Ravenel and Curtis, and discoverer of the rare *Trichomanes Petersii*. In a chapter headed "Pteridographia" ¶ is a series of notes on *Asplenium montanum*, *Osmunda cinnamomea*, *Schizæa pusilla*, *Polypodium vulgare auritum*, on a form of the Lady-fern with red stipes, etc.

Ferns of the Dutch West Indies.**—I. Boldingh includes in his Flora of the Dutch West Indian Islands, a list of the Pteridophytes amounting to fifty-two species. The islands explored were St. Eustatius, Saba, St. Martin, and also St. Croix. The collections examined are those of Suringar, van Grol-Meyers, Lionaron, and Boldingh. Altitudes and general distribution are given.

Spruce's South American Ferns.††—E. Rosenstock publishes a series of thirty-eight descriptions of new species and varieties of ferns collected by the late Richard Spruce on the Amazons, in East Peru and in Ecuador, founded on specimens preserved in the herbarium of Prince Roland Bonaparte. About 500 of Spruce's specimens were thus submitted to Rosenstock for determination. Though many of them have been named and described by Hooker, Baker and others, yet a number of them have never been determined, and some in the light of modern research are found to differ from the species to which in the past they have been referred.

Ferns of the Congo.‡‡—E. De Wildeman publishes a list of the Pteridophytes of the lower and middle Congo, amounting to 103 species and two varieties. Among them are eight new species described by H. Christ.

* Fern Bulletin, xvii. (1909) pp. 100-2.

† Tom. cit., p. 105.

‡ Tom. cit., pp. 99-100 (pl.) and pp. 107-12.

§ Leiden: Brill, 1909, pp. 1-12.

¶ Fedde's Repertorium, vii. (1909) pp. 289-310.

** Ann. Musée Congo Belge, Bot., sér. 5, iii. (1909) pp. 23-41.

† Tom. cit., pp. 102-5.

§ Tom. cit., pp. 106-7 (fig.).

¶ Tom. cit., pp. 112-20.

Ferns of Ruwenzori.*—R. Pirotta gives an account of the ferns collected on Mount Ruwenzori during the expedition of Prince Luigi Amadeo of Savoy, Duke of the Abruzzi. Twenty-five species are enumerated, and were all collected in the Mobuku Valley. Four of them are new to science.

Ferns of the Far East.†—H. Christ publishes an account of some collections of ferns from the Far East, viz.:—1. 122 species collected in Corea by Faurie and Taquet; nine of these are new, and are accompanied by descriptions. 2. Twenty-five species from the island of Saghalien, collected by Faurie, including two new species. 3. Eighty-three species collected in the neighbourhood of Pin-Fa, in South China, by Cavalerie, eleven being new species.

New Species of Malesian and Philippine Ferns.‡—H. Christ publishes descriptions of five new species of ferns collected in Luzon, Penang, Perak and Saigon, by C. G. Mathew in 1906–8.

Bryophyta.

(By A. GEPP.)

Relationship of Liverworts to Ferns.§—E. Lampa discusses the relation between the liverwort-thallus and the fern-prothallium. It is held by many that the liverworts, though apparently more simple morphologically, yet developmentally stand higher than the mosses. This view is supported by the fact that the anatomical structure of the liverworts represents a degree of organisation superior to that of the mosses. A further confirmation of this view is to be found in the ontogenesis, which indicates that the apparent morphological simplicity of the liverworts is to be regarded as a reduction from a higher degree of development. The author throws further light upon this by her investigation of the germination of the spores of *Peltolepis grandis*, and finds therein evidence of a clear relationship of the liverworts to the ferns.

Sporogonium and Gametophore of Conocephalum.||—M. Graham describes her investigations as to the development of the sporogonium of *Conocephalum conicum*, and also of the adjacent tissues of the gametophore, in order to determine the origin of the sheath which surrounds and incloses the calyptra, and to prove whether it bears any relation to the pseudo-perianth found in *Marchantia* and *Preissia*. She finds that this sheath in *Conocephalum* is not to be confused with the pseudo-perianth of *Marchantia* and *Preissia* which arises from cells immediately beneath the base of the archegonium, cells descended from the original cell from which the mother-cell of the archegonium was cut off. The sheath in *Conocephalum* arises from the gametophore tissue surrounding the archegonium, and consists of several distinct laminae which are morphologically walls of air-chambers. The function of the sheath is doubtless to protect the sporogonium through the winter.

* Il Ruwenzori. Milan: Hoepli, 1909, i. pp. 477–83.

† Bull. Acad. Internat. Géogr. Bot., xviii. (1909) pp. 146–78.

‡ Journ. Linn. Soc., xxxix. (1909) pp. 213–15.

§ Oesterr. Bot. Zeitschr., lix. (1909) pp. 409–14 (figs.).

|| Bull. Torrey Bot. Club, xxxvi. (1909) pp. 615–23 (4 pls.).

Liverwort Types for Elementary Classes.*—W. C. Coker raises a protest against the use of so complex and difficult a plant as *Marchantia* for demonstrating to students the structures concerned in the alternation of generations. The complex thallus, the stalked and still more complex archegoniophores and antheridiophores, the hidden antheridia, the small sporophytes concealed amid delicate vestments difficult to distinguish, render *Marchantia* a formidable object to the beginner. Far better and simpler is such a type as *Pallavicinia Lyellii*, in which by one section may be shown a longitudinal view of the young sporophyte and its envelopes, and a transverse view of the gametophyte. The male plant is equally simple, and the antheridia large. For showing the structure of the capsule and the relation of its contents, he prefers a species of *Frullania*. Here the elaters extend the whole length of the capsule and alternate with single rows of spore mother-cells.

Physiology of Liverwort-rhizoids.†—H. Weinert has investigated the growth and the phenomena of tropistic movements of the rhizoids of thalloid liverworts under the influence of light and gravity, also the physiology of the tuberculate rhizoids. He finds that bright light is favourable to the development of the rhizoids. In the dark no spreading rhizoids are formed, and fewer than usual of the appressed tuberculate rhizoids. Blue and red lights suppress the formation of rhizoids. Injured rhizoids do not undergo regeneration. As regards the gemmæ, their production of rhizoids is extraordinarily sensitive to the access of water, and the outgrowth of rhizoids on the under side is induced by gravity; they are also negatively heliotropic. The thallus rhizoids are little or not at all affected by unilateral illumination. Red rays have a strongly negatively heliotropic effect upon the gemmæ-rhizoids. Blue light has no heliotropic effect on the rhizoids. Gravity has no effect upon the rhizoids of thallus or gemmæ, either at the time of growth or afterwards. The appressed tuberculate rhizoids are not tropistically affected by either lateral illumination or gravity.

Biology of the Archegonium and Calyptra.‡—F. Zielinski discusses the biology of the archegonium and of the calyptra of mosses. In summing up his results he says:—1. The opening of the archegonium is due to separation of the apical cells, brought about by the slime imbedded in the cells. 2. The calyptra separates itself from the vaginula along a zone specially prepared for the purpose. Many mosses have an inflated calyptra which serves as a water-store, from which the embryo in early stages can absorb water. 3. The greater or lesser development of the calyptra is proportional to the greater or lesser susceptibility of the sporogonium to external injury, especially to drought. Sporogonia which have been robbed of their calyptra accelerate their growth and strive to attain maturity. 4. The formation of hairs on the calyptra is the clearest expression of the above-mentioned susceptibility, and bears a direct relationship to the habitat of the respective mosses. It is sometimes liable to become obscured by other

* Torrey, ix. (1909) pp. 233-6 (figs.).

† Bot. Zeit., lxxvii. (1909) pp. 201-31 (figs.).

‡ Flora, c. (1909) pp. 1-36 (figs.).

factors. 5. Among hairy calyptras several types may be distinguished which are characteristic of the different groups: for instance, the unicellular basal descending hairs of the Campylopoideæ, the multicellular ascending hairs of the Orthotrichaceæ, the long felted hairs of *Polytrichum*. In most groups a progressive development of the hairs is to be observed.

Life-history of *Funaria hygrometrica*.*—P. Janzen gives a complete account of the life-history of *Funaria hygrometrica*, with much detailed text and copious figures. He describes his carefully watched cultures, the spores, the protonema, moss-bud, rhizoids, bulbils, root-parasites; then the moss-plant, its branching, stem, leaves, manner of inflorescence (male and female), calyptra, embryo, sporogonium, seta, capsule, stomata, peristome. His notion was to give the whole story without any gap.

Accessory Leaves in *Mnium* and *Orthomnion*.†—H. N. Dixon gives an account of some undescribed structures in *Mnium*, namely, certain accessory leaves or leaf-like appendages, which occur here and there among the normal leaves on the stoloniform branches. He describes their characters in *M. affine*, *M. cuspidatum*, *M. rostratum* and other species, also in *Orthomnion crispum*, *O. trichomitrium*, and *O. Loheri*. He also publishes some notes on the genus *Orthomnion* with a view to clearing away the confusion which surrounds the species. The type is *O. crispum*, from which the other original species *O. trichomitrium* is distinguished by little save its organs of fructification. To *O. crispum* must be referred as a species the *Mnium subcrispum* of C. Müller. The *M. pseudocrispum* of C. Müller must, however, be referred to *M. rostratum*. The nerve structure in *Orthomnion* is simpler than in most species of *Mnium*.

Monograph of the Hepaticæ.‡—F. Stephani continues his monographs of the genera of hepatics, giving a Latin description of every species. A large percentage of the species are new to science. The genera treated of are as follows:—*Mastigobryum* (74 species, a continuation), *Mastigopelma* (2 species), *Acromastigum* (1), *Micropterygium* (9), *Mytilopsis* (1), *Psiloclada* (3), *Sprucella* (1), *Lepidozia* (218), *Arachniopsis* (3), *Blepharostoma* (12), *Chandonanthus* (8), *Anthelia* (3), *Herpocladium* (3), *Isotachis* (49), *Schisma* (71), *Lepicolea* (5), *Chetocolea* (1), *Mastigophora* (10), *Ptilidium* (5), *Lepidolæna* (9), *Trichoclea* (32). The greater part of this work has been published in the Bulletin de l'Herbier Boissier, a periodical now defunct.

Muscineæ of Yorkshire.—T. Sheppard, § in his account of the visit of the Yorkshire Naturalists to Sedbergh, publishes some notes on the rare mosses collected; for instance, *Campylopus atrovirens* var. *gracilis* Dixon, *Rhabdoweisia denticulata* and others at Cautley Spout, *Trichostomum crispulum* in Helm Gill, and *Pterogonium gracile* by the River Lune.

* Schrift. Natur. Ges. Danzig, xii. heft 3 (1909) pp. 1-44 (many figs.).

† Rev. Bryolog., xxxvi. (1909) pp. 141-7.

‡ Species Hepaticarum. Genève et Bâle: Georg et Cie., 1909, iii. pp. 517-693; iv. pp. 1-64.

§ Naturalist, No. 633 (1909) pp. 345-8.

W. Watson* records the occurrence of *Aplozia riparia* var. *potamophila* Bernet in an upland stream in Greenfield, Yorks., and gives a list of the species with which it is associated. The variety had been previously recorded from Scotland and the Isle of Man. The Greenfield plant is unusually large, and much resembles *A. cordifolia*.

New Scottish Mosses. †—J. Stirton gives an account of some new and rare mosses from the West of Scotland. He describes as new species the following:—*Dicranoweissia sutherlandi*, *Mollia thrausta* (= *M. tortuosa* var. *fragilifolia* Lorentz), *M. intumescens*, *M. conspersa*, *M. subbifaria*, *Grimmia subaquila*, *Anacetangium marinum*, *Dichodontium fulvescens*. He calls attention to the structure of the acumen of the leaf of *M. tortuosa*; records the discovery of fruiting specimens of *M. inclinata* for the first time in Britain; and announces that his own *M. aggregata* is probably merely a curious form of *M. fragilis*. He also publishes some further details about *M. terrena*.

Norwegian Moss-flora. ‡—I. Hagen issues the third portion of his treatise on the moss-flora of Norway, and treats of the Grimmiaceæ, Timmiaceæ, Schistostegaceæ, and Hedwigiaceæ, providing keys to the genera, sub-genera, and species. The remarks on distribution are in Norwegian; but the critical systematic remarks are in French, since they appeal to a wider range of students.

Russian Bryophytes. §—J. P. Petrow § enumerates sixty-three species of mosses collected in the environs of Moscow. A. A. Sapelin || publishes a list of thirty-five mosses and one hepatic, collected in the Governments of Kherson and Ekaterinoslav in South Russia.

Hepatics of the Haute-Saone. ¶—A. Coppey gives an account of the hepatics of the Haute-Saone, prefaced by a sketch of the physical geography of the department and of the literature already published on its moss-flora. The enumeration contains seventy-eight species and a few varieties. *Inter alia* he sums up in parallel columns the respective characters of *Aneura multifida* and *A. sinuata*.

New German Mosses. **—C. Grebe describes in detail two new mosses—*Ditrichum julifiliforme*, from Rheine in Westfalen, and *Tortula calcicola*, from walls in Obermarsberg in Westfalen, and from various other places in Middle Germany. The former is quite a distinct species. The latter is allied to *T. ruralis*. The author adds an historical sketch of the species of the group of *T. ruralis*, and shows how the plants may be distinguished in the sterile state. He appends a key for the ten species of the group. Four of these are found on bark—*T. latifolia*, *T. papillosa*, *T. pulvinata*, *T. lævipila*. And six are found on the rocks and earth—*T. calcicola*, *T. montana*, *T. ruralis*, *T. aciphylla*, *T. alpina*, *T. Muelleri*. Minor differences are found in characters of stem and leaf.

* Journ. Bot., xlvii. (1909) p. 447.

† Ann. Scot. Nat. Hist., No. 71 (1909) pp. 168-73, 241-6.

‡ K. Norsk. Vidensk. Selsk. Skrift., No. 5 (1909) 114 pp. (figs.).

§ Bull. Jard. Imp. Bot. St. Pétersbourg, ix. (1909) pp. 45-64.

|| Tom. cit., pp. 10-14.

¶ Rev. Bryolog., xxxvi. (1903) pp. 118-28, 147-52.

** Hedwigia, xlix. (1909) pp. 66-77.

Hepatics of Eisenach.*—P. Janzen publishes a list of the hepatics of the neighbourhood of Eisenach, of which no account had previously been given, though the mosses of the district had been recorded by J. Röhl and A. Grimme. Sixty-eight hepatics are enumerated, including *Reboulia hemisphærica* and *Lejeunia calcarea*.

Moss-flora of Zillerthal.†—L. Lorsche gives an account of the mosses and hepatics of the Zillerthal Alps, prefaced by remarks on the geology and physical geography of the district. He indicates some of the special moss-habitats in the neighbourhood, and describes several moss-associations which he frequently met with. He obtained a few new varieties or forms, added four species to the flora of Tirol, and detected a score of rarities which are not common in Tirol. He enumerates about ninety-five hepatics and over 270 mosses, interspersing them with many critical notes and here and there with lengthy arguments on difficult questions.

Mosses of Hungary.‡—I. Györfy publishes an enumeration of the Sphagnaceæ collected by him in the Hohe-Tatra Mountains, and submitted to J. Röhl and to C. Warnstorf for determination. These comprise seventeen species and numerous varieties, several of which are additions to the Hungarian flora.

Moss-flora of Moravia.—J. Podpera § publishes notes on the bryology of Moravia, including many species new to the country, and one species and two varieties new to science. The differences between *Isopterygium depressum* and *I. densifolium* are carefully detailed. He also describes ¶ the geographical distribution of the Bryophytes of Moravia, and compares them with those of Bohemia.

Moss-flora of Greece.¶—A. Coppey publishes a second contribution to the study of the moss-flora of Greece. His previous paper appeared in 1907. The present addition is based on 320 specimens collected in the plains of Thessaly, in Attica and the Morea, by René Maire during April and May 1908. As a consequence the Greek moss-flora is increased by thirty species. The total number of hepatics recorded till the present time for Greece is about forty species, while that of the mosses is 215. Some critical notes are inserted in the list, and two species are discussed in greater detail—namely, *Cheilothela chloropoda* Lindb. (*Ceratodon chloropus* Brid.), the characteristics of which are figured; and secondly, *Mielichhoferia Coppeyi* Card., a new species; and the type of a new sub-genus (*Haplodontiopsis*). The morphology of this plant is also figured. The author devotes a chapter to the geographical distribution of the Bryophytes in Greece, giving lists of the species found in the Mediterranean province, the northern mountain province, the latter being divided into the lower region (up to 1000

* Mitt. Thüring. Bot. Verein. v. heft xxv. (1909) pp. 35–40.

† Hedwigia, xlix. (1909) pp. 1–53.

‡ Magyar Bot. Lapok, viii. (1909) pp. 222–38.

§ Ber. Komm. Nat. Durchforsch. Mährens. Brünn, No. 5 (1908) 41 pp.

¶ Mitt. Nat. Klub Prossnitz, xi. (1908) 24 pp.

¶ Bull. Soc. Sci. Nancy, 1909, 50 pp. (2 pls. and map).

metres), the forest region (1000 to 1800 metres), the sub-alpine (above 1800 metres). Finally, he discusses the origin of some of the Mediterranean species, especially the new endemic *Mielichhoferia Coppeyi*, a representative of an exotic genus mostly of southern distribution.

Moss-flora of Portugal.*—A. Luisier publishes a preliminary list of Portuguese mosses—thirty-three species collected in the neighbourhood of S. Fiel and Lisbon. He has in hand much more material waiting to be worked out.

Moss-flora of Madeira.†—A. Luisier gives a list of the Bryophytes of Madeira—seventeen hepatics and eighty-one mosses, including three new varieties. Three genera and eight species and varieties are added to the Madeiran flora.

Mosses of Italian East Africa.‡—L. Micheletti gives an enumeration of eighteen species of mosses collected by A. Rolli and M. Da Carbonara in the Italian colony of Eritrea. Among them are the names of ten new species determined by V. F. Brotherus, but without diagnoses.

Bryophyta of Ruwenzori.—G. Negri§ gives an account of the mosses collected on Mount Ruwenzori during the Duke of the Abruzzi's expedition. The total number of species recorded from Ruwenzori is 62; 38 of these were collected by the expedition, among them being 23 new species and 2 new varieties. G. Gola|| enumerates the number of hepaticæ recorded from Ruwenzori—namely, 50 species. The Duke of the Abruzzi's expedition collected 33 species, 16 of which are new to science.

North American Species of *Amblystegium*.—A. J. Grout¶ publishes some notes on *Amblystegium*, the North American species of which he has lately studied with great care. He found the European experts to be at variance over such difficult species as *A. hygrophilum*, *A. radicale*, *A. orthocladon*, *A. Kochii*. He maintains that the minute ecostate species ought to be removed to the Hypnæ. The remaining unicostate species can then be divided into four groups: 1. *Euamblystegium*, with five species (*A. serpens*, *A. Furatzkanum*, *A. Kochii*, *A. compactum*, *A. Holzingeri*). 2. *Hygroamblystegium*, with six species (*A. varium*, *A. fluviatile*, *A. irriguum*, *A. orthocladon*, *A. noterophilum*, *A. filicinum*). 3. *Leptodietyum*, with six species (*A. riparium*, *A. brachyphyllum*, *A. brevipes*, *A. luxirete*, *A. vacillans*, *A. floridanum*). 4. *A. Lescurii* (transferred to *Sciaromnium*, by Brotherus). Each of these four groups is critically discussed. A new species and a new variety are described. E. J. Hill** gives an account of the habitats and plant-associations of *Amblystegium noterophilum*, a cold-water species which he has found in fruit.

* Ann. Acad. Polytech. Porto, ii. (1907) 7 pp.

† Brotéria, Botanica, viii. (1909) pp. 31-45.

‡ Bull. Soc. Bot. Ital., 1909, pp. 154-6.

§ Il Ruwenzori. Milano: Hoepli, i. (1909) pp. 485-510 (2 pls.).

|| Tom. cit. pp. 511-35 (3 pls.).

¶ Bryologist, xii. (1909) pp. 95-100 (pl.).

** Tom. cit., pp. 103-9.

North American Bryophytes.—W. C. Coker* records some rare abnormalities in liverworts: 1. *Aneura pinguis*, with twin sporophytes inclosed in a single calyptra. The calyptra the author shows to be the product of the coalescence of two. 2. In the same species, an unfertilised archegonium which had, like the others, been carried up on the calyptra of a young sporogonium, but which, unlike the others, had undergone a fair amount of growth, possibly induced by a sympathetic response to the vitalising influence of the adjoining sporophyte. 3. An instance of fasciation in *Preissia quadrata* is figured, showing an archegoniophore of twice the normal width and forked near its apex. E. G. Britton† briefly enumerates the Arctic mosses identified by N. Bryhn in the collections of Lieut. Peary in Grant Land (1902), and of L. J. Wolf at Wrangle Bay, Lincoln Bay, and Grant Land (1906). In all 57 mosses and 5 hepatics.

Hepaticæ of New England.‡—A. W. Evans publishes his seventh chapter of notes on New England hepaticæ. Therein he discusses eight species, five of which are additions to the New England flora; and the remaining three, though previously recorded, required distinct confirmation. He discusses the relationship of *Metzgeria furcata* to *M. conjugata*, their anatomical resemblances and differences, and the taxonomic value of the marginal gemmæ in *M. furcata*. *M. crossipilis* he raises to specific rank; this species produces gemmæ on the antical surface of the thallus-wings. He insists upon the great taxonomic value of the vertical bands of thickening in the walls of the median internal cells of the thallus of *Pellia Neesiana*, as distinguishing sterile plants of it from those of *P. Fabroniana* (*P. endiviæfolia*). Other species discussed are *Cephaloziella elachista*, *C. Hampeana*, *Calypogeia Neesiana*, *Scapania glaucocephala*.

Mexican Hepaticæ.§—F. Stephani publishes descriptions of nine new species of hepaticæ collected in Mexico by Pringle—viz. *Anthoceros Pringlei*, *A. turbinatus*, *Cheilolejeunea fissistipula*, *Cyathodium mexicanum*, *Fimbriaria Pringlei*, *Leioscyphus Pringlei*, *Metzgeria brevisetu*, *Radula calcarata*, *Symphlogyna mexicana*.

Bolivian Mosses.||—R. S. Williams publishes a second paper on Bolivian mosses. The first part appeared in 1903. The specimens treated of were collected during the expedition of Martin Conway in 1901-2. The present part comprises nearly 200 species, and includes descriptions of eighteen new species.

New Philippine Mosses.¶—V. F. Brotherus publishes descriptions of eleven new species of Philippine mosses collected by A. D. E. Elmer in Negros and Luzon.

Mosses of New Guinea and the Moluccas.**—Th. Herzog gives an account of two collections of mosses, one of fifteen species collected

* Bryologist, xii. (1909) pp. 104-5 (figs.). † Tom. cit., p. 106.

‡ Rhodora, xi. (1909) pp. 185-95.

§ Rev. Bryolog., xxxvi. (1909) pp. 138-40.

|| Bull. New York Bot. Garden, vi. (1909) pp. 227-61.

¶ Leaflets of Philippine Botany, Manila, ii. (1909) pp. 651-8.

** Hedwigia, xlix. (1909) pp. 119-27 (pl.).

in German New Guinea by E. Werner, and the other sent from Buru in the Molucca Islands by K. Deninger. Six of the New Guinea species have never been described before, and one of them represents a new genus—*Werneriolobryum*, the type of a new family. Notes on distribution and critical remarks are added.

Bryophyta of Fiji.*—A. Gepp contributes a list of twenty-six mosses and twenty-five hepatics to L. S. Gibbs's account of the Montane flora of Fiji. The specimens were mostly gathered at Nadarivatu, and at altitudes ranging between 2700 and 4000 feet. One new hepatic is described.

Some Forms of Drepanocladus.†—F. Renauld publishes notes on some forms of *Drepanocladus* or *Harpulia*. He discusses critically *D. fluitans* var. *serratus*, var. *submersus*, var. *Lindbergii*, var. *Mildei*. He considers that var. *Lindbergii* is distinct from var. *submersus*, but is less capable of being adequately distinguished from var. *Mildei*. He discusses also the mode of inflorescence of var. *Lindbergii*. He provides a table of the groups of varieties established in *Drepanocladus fluitans* and *D. exannulatus*.

Drepanocladus furcatus.‡—G. Roth replies briefly to the criticisms of L. Loeske and W. Mönkemeyer concerning his views of *Drepanocladus furcatus*, and in support of his own position quotes some appreciative remarks by Renauld.

Some Critical Species of Pohlia.§—Winter publishes an account of his observations of the four critical species, *Pohlia commutata*, *P. gracilis*, *P. cucullata*, and *P. carinata*, discussing the various forms of each, their habitats and distribution, and the minute differences between them.

Bryum arvernense.||—J. Douin gives a description and figure of *Bryum arvernense*, a new species collected on Puy-de-Dôme, and resembling *B. argenteum* in habit, but probably allied to *B. Bliulii*. Its systematic position is uncertain until its sporogonium has been found and studied. There are numbers of other recently created species in the same genus which have no better claim to be regarded as valid species. The whole genus is in a chaotic condition, incomprehensible to all bryologists.

Some Bryological Rarities.¶—I. Györfy gives an account of some bryological rarities. 1. Certain endorhizoid cells which occur at the foot of the sporogonium of *Molendoa Hornschuckiana* he figures. The same thing has been found in *Diphyscium*, *Buzbaumia*, and *Eriopus remotifolius*. 2. A monstrous form of the sporogonium of *Dicranum Blyttii* in the Hohen Tatra. The seta forks above and bears two capsules.

* Journ. Linn. Soc., xxxix. (1909) pp. 189-96.

† Rev. Bryolog., xxxvi. (1909) pp. 129-38.

‡ Hedwigia, xlix. (1909) p. 106.

§ Tom. cit., pp. 54-65 (2 pls.).

|| Rev. Bryolog., xxxvi. (1909) pp. 153-4.

¶ Hedwigia, xlix. (1909) pp. 101-5 (pl.).

John Henry Davies (1838-1909).*—H. W. Lett publishes an obituary notice of J. H. Davies, a bryologist who spent most of his life in Ireland. In 1857 he visited the Isle of Man, and compiled a list of all the mosses he could find; and he was an active member of the Yorkshire Naturalists. During the next half-century he resided in Ireland, and was busily engaged in some linen bleach-works. But after retiring from work some few years ago he again reverted to the study of mosses, and published some seven papers on new or rare mosses collected in Ireland.

A. Geheeb: Necrology.—T. Husnot † gives an obituary notice of Adalbert Geheeb, born in 1842 at Geisa (Saxe Weimar), died September 1909. He succeeded to his father's pharmacy business in Geisa in 1867, and carried it on for thirty years. From the year 1858 he worked at bryology. He paid special attention to the moss-flora of the Rhöngebirge, but he also published or collaborated in several papers on exotic mosses. His herbarium has been purchased by a friend and presented to the Berlin Museum.

J. Röhl ‡ writes a somewhat fuller notice of the same bryologist, and adds a portrait of him taken in 1907. He gives a brief résumé of his chief bryological journeys, and of his various contributions to the literature of mosses. Geheeb was artistic: he played the violin and wrote poems; he also prepared with great skill some landscapes composed of mosses. As a collector he was distinguished for his great powers of observation and his knowledge of the peculiarities of mosses and of their habitats.

Leo Lesquereux.§—A. M. Smith publishes a biographical notice of Leo Lesquereux (born 1806, died 1889). Born near Neufchâtel, in Switzerland, he devoted much time to the study of mosses and the formation of peat-bogs; for a treatise on the latter he gained a gold medal awarded by the Swiss Government. In 1848 he followed his friend Agassiz to America, and soon began to co-operate with W. S. Sullivant in Bryology. Together they published the *Musci Americana Exsiccati*, the report on the mosses of Wilkes' South Pacific Exploring Expedition, the *Icones Muscorum*, etc. Lesquereux also studied the coal formations of the United States, publishing various reports and catalogues of the plants of the Coal Measures. He collaborated with T. P. James in the preparation of the *Manual of American Mosses* (1884).

Thallophyta.

Algæ.

(By MRS. E. S. GEPP.)

Coccomyxa subellipsoidea, a New Member of the Palmellaceæ.|| E. Acton describes the above-named alga, which is widely distributed in all parts of the British Isles, occurring only in subaerial habitats,

* Irish Naturalist, xviii. (1909) pp. 235-6.

† Rev. Bryolog., xxxvi. (1909) p. 155.

‡ Allgem. Bot. Zeitschr., xv. (1909) pp. 165-7 (portrait).

§ Bryologist, xii. (1909) pp. 75-8 (portrait).

|| Ann. Bot., xxiii. (1909) pp. 573-77 (1 pl.).

generally on damp rocks and stones. It forms a thin mucous stratum of a dark green colour, which, when dry, becomes almost black and peels off the stone. The stratum consists of large numbers of thin-walled cells imbedded in a colourless mucilage. These cells are, for the most part, somewhat irregularly or obliquely ellipsoid. Multiplication takes place by oblique fission, the mother-cell dividing into two, or occasionally four, daughter-cells. Reproduction takes place by the formation of four, rarely eight, non-motile gonidia, and also by the formation of macro- and micro-zoogonidia, 2, 4, 8, and 16. The cultures of the alga, grown by the author, are described, as well as her observation of the formation of zoogonidia. As regards the systematic characters of *C. subellipsoidea*, it differs from *C. dispar* Schmidle, in the greater regularity in the form of the cells and in the presence of pyrenoids. It shows a great resemblance to *Oocystis submarina* Lag., in the oblique division, and in the form of the cell and of the chloroplast.

Sphærella lacustris.*—F. Peebles describes the life-history of *Sphærella lacustris*, with special reference to the nature and behaviour of the zoospores. The cycle of development is discussed and the author's views compared with those of other authors. The results are summarised as follows:—1. Normal resting-cells from wild cultures always produce asexual zoospores by endogenous division. These spores swim about for a short time, gradually becoming larger, and finally assuming the typical pear-shape with distended cell-wall, long flagella, and protoplasmic threads between the wall and the central mass. 2. The zoospores divide, either while swimming about or after a short period of quiescence, forming several generations of motile spores. Multiplication is by endogenous cell-division, and in rare cases by fission. 3. After a number of generations have been produced, the cells settle down for a period of rest and growth. Many of them attain great size, and finally divide into 16 to 32 non-motile cells, which, in turn, grow into large resting-cells. They divide in the usual way, forming a new generation of zoospores. 4. Resting-cells, which have been subjected to adverse conditions, such as starvation, cold, rapid drying, or a very brief rest, usually produce small motile spores of gametes. 5. By conjugation two gametes form a zygospore. This zygospore remains active for a few hours, then settles down, secretes a wall about itself, losing its four flagella. After a period of growth and rest, the zygospore continues the cycle of development by dividing to form the asexual zoospores. Finally the author suggests that since the megazoids are known to be asexual and the microzoids sexual, they should be termed respectively zoospores and gametes.

Scenedesmus.†—Schmida describes a new species of *Scenedesmus*, *S. productocapitatus*, which was found in a ditch near Oppeln. Specimens are to be distributed on tale, as No. 728 of the Phykotheka Universalis. Nine other species of fresh-water algæ are enumerated, which were found at the same place.

* Centralbl. Bakt. Parasitenk., 2te Abt., xxiv. (1909) pp. 511-21 (figs.).

† Hedwigia, xlix. (1909) pp. 85-7 (figs. in text).

Algological Prophecy Fulfilled.*—F. S. Collins announces the fulfilment of a prophecy made by Lagerheim some time ago, when describing *Chætomorpha herbipolensis*, at that time the first fresh-water species of the genus. Lagerheim said that the desmids he had studied on specimens of aquatic phanerogams, collected long ago by B. D. Greene in Massachusetts, indicated that the algal flora of Massachusetts was of almost a tropical character, and that fresh-water species of *Chætomorpha* were to be expected there. Since that time F. S. Collins has described another fresh-water *Chætomorpha*, *C. chelonum*, which was growing on a turtle in Michigan, and he has searched for further material in many ponds in New England, but in vain. Now he finds a turtle on the banks of the very pond from which B. D. Greene collected his desmids, and on this turtle's back is the fresh-water species of *Chætomorpha*, for which he had hunted so long. Lagerheim's prophecy, therefore, that fresh-water species of *Chætomorpha* should be found in Massachusetts was fulfilled by the finding of it in the very same pond as the desmids which he had examined, and which had led him to utter the prophecy.

Phytoplankton of the English Lake District.†—W. and G. S. West conclude their account of the phytoplankton of the English lake district. Species of Flagellata and Peridiniæ are recorded, and then the authors devote a section to the peculiarities of the English lake-plankton. They state that it contains a varied assortment of algæ, 64 p.c. of which belong to the Chlorophyceæ, 21 p.c. to the Bacillariæ, and only 9.5 p.c. to the Myxophyceæ. The total is 188 species and 20 varieties. Of 120 species of Chlorophyceæ, 96 are desmids, so that 51 p.c. of all the species recorded for the plankton belong to the Desmidiaceæ. Nevertheless, though the English lakes contain so high a percentage of species, they are not so rich in actual numbers of desmids as the Scottish or Welsh lakes. *Spondylosium pulchrum* var. *planum* is abundant generally. A table shows the abundance of desmids in the British lakes as compared with some of the lakes of continental Europe. There are relatively few Protococcoideæ, but the diatoms are very conspicuous in the plankton of some of the English lakes. The Myxophyceæ are almost as poorly represented as in the Scottish lakes, the number of species being relatively few. Among the Flagellates, the genus *Dinobryon* is conspicuous; and among the Peridiniæ, *Peridinium Willei*. The latter is one of the leading features of the plankton of the English lake district. Lists are given of those species which are exclusively confined to the plankton, and of those which are much more abundant in the plankton than elsewhere. The authors notice that a greater bulk of plankton occurs in those lakes which are slightly contaminated by the presence on their shores of small villages and farms, and this they attribute to the slight increase of food constituents arising from the sewage. The experience of the authors is not in support of the view of Huitfeldt-Kaas, that small depth is favourable and great depth unfavourable to the development of plankton.

* *Rhodora*, xi. (1909) pp. 196-7.

† *Naturalist*, Sept. 1909, pp. 323-31 (figs.).

Fresh-water Algæ from Ruwenzori.*—G. B. De Toni and A. Forti have examined the nineteen samples of fresh-water algæ collected in the Ruwenzori area by the Duke of the Abruzzi. They record two species and one variety of Myxophyceæ, two species of Chlorophyceæ, and thirty-five species and thirty-four varieties and forms of Bacillariæ. Of these, two varieties are new to science. They find a great resemblance between certain of the samples and the flora of El Kab in Upper Egypt, especially in the richness of forms of *Rhopalodia gibberula* O. M., of *Navicula sphærophora* Kütz., and some other species. They also record the widely-distributed *Chlamydomonas nivalis* Wille from the Dnuoni glacier, a fact which helps to confirm the opinion, expressed by Chodat, that the Chlamydomonads of the snow are the most widely-distributed plants in the world. They range from the North to the South Pole, and are probably the pioneers of vegetation in the glacial regions. The species of diatoms recorded from Ruwenzori correspond for the most part with the species designated by Ehrenberg as terrestrial—for instance, *Navicula borealis*, *Hantzschia amphioxys*, *Melosira Roescana*, *Navicula mutica* f., etc. The authors give a list of the localities whence the samples were obtained, with the predominating character of each, and later give a systematic account of the collection with synonyms, and critical or geographical notes.

Microspore-formation in Chætoceras Lorenzianum.†—J. Schiller describes the formation of microspores in *Chætoceras Lorenzianum*, a plankton-species collected in the Adriatic, where it is fairly common. He gives, first, a short description of the diatom, and states that he has never seen either the resting-spores or the auxospores. The greatest development of *C. Lorenzianum* takes place in the autumn, October and November, and to a rather less extent in the late spring and early summer. But the species is remarkable for the irregularity and abruptness of its appearance. It is, however, never entirely absent from the Adriatic plankton. The author describes the method of catching and fixing the material, and then proceeds to give details as to the formation of the microspores in the mother-cell. A mother-spore is first formed, and this divides then into the daughter-spores. The behaviour of the nucleus is not always to be followed out, since the chromatophores surround it and prevent it from being seen. The author distinguishes two types of microspores, the first being quite round, and varying from 2·8–3·3 μ . No cilia were visible, and no active movement could be observed. The second type had a more oval form, one end being rounded and the other more or less acute. The chromatophores were distinctly visible, but neither here could cilia or movement be recorded. These microspores vary in size from 5–2·7 μ in diameter. The view is taken by the author that these two types represent a sexual differentiation, but, as he says, proof may long be sought for, since the culture of plankton is as yet an unsolved problem. Neither the ripe spores nor the various intermediate stages are provided with a distinct membrane, but each spore is surrounded by a very fine coating of

* Il Ruwenzori, Milano (Hoepli), i. (1909) 31 pp.

† Ber. Deutsch. Bot. Gesell., xxviii. (1909) pp. 351–61.

hardened protoplasm. The scarcity of records of microspore-formation in plankton diatoms is explained by the author by the theory that it occurs very rarely in a vegetative cell, but takes place normally at the germination of the resting-spore, a process which has never yet been watched.

Algæ of Suffolk and Norfolk.*—E. N. Bloomfield publishes lists of the marine algæ and fresh-water algæ and Diatomaceæ of Suffolk, consisting principally of records made by Batters. The coast of Suffolk is very unfavourable to the growth of algæ, most of it being covered with sand and shingle, while there are no hard rocks. Taking this into account the list is a good one, consisting of 135 species. The list of fresh-water algæ and Diatomaceæ, including both fresh-water and marine species, is almost entirely derived from Henslow and Skepper's Suffolk Flora, 1860. A few additions were made by the late W. West, junr.

E. N. Bloomfield adds a short list of twenty-two marine species taken from Batters' Catalogue of British Marine Algæ, which have been found on the coast of Norfolk, and are additional to those given in H. D. Geldart's List of Norfolk Marine Algæ published in these Transactions, vol. iii.

Fresh-water Plankton.†—R. Kolkwitz examines the connection between the composition of water and the development of plankton, as observed in the Lietzensee near Charlottenburg. After some general remarks on the composition of the water of lakes and ponds, their chemical analysis, and plankton, he describes the Lietzensee in some detail. That water appears to be infested by *Oscillatoria Agardhii* at certain seasons of the year, and the author gives a synopsis of its affinities. The final chapter deals with the causes of the production of such masses of *Oscillatoria*, after which the results of the paper are summed up.

A. A. Elenkin‡ studied the qualitative plankton of Lake Sseliger for three months, from the end of May to the 20th of August, 1908. The most important species are enumerated. The rare *Attheya Zachariasi* J. Brun was present. The paper is in Russian, with a German summary.

Periodicity of Algæ.§—W. Benecke has made experiments on the periodicity of algæ, having special regard to the formation of zygotes in *Spirogyra communis*. In that species the resting-cells germinate in the spring, and floating masses are formed. In summer these disappear, zygospores having been formed by copulation in the meantime. In the autumn growth is feeble, diminishing towards winter. There is no more formation of zygotes. The experiments of the author go to show that this periodicity is regulated by the quantity of nitrogenous combinations, be they nitrates or ammonium salts or organic combinations. The possible cause for the diminution of these substances in the open

* Trans. Norfolk and Norwich Nat. Soc., viii. (1908-9) pp. 768-83, 809-10.

† Landw. Jahrb. Ergänzungs., v. (1909) pp. 449-72 (1 pl.).

‡ Bull. Jard. Imp. Bot. St. Pétersbourg, ix. (1909) pp. 15-21.

§ Internat. Rev. Hydrobiol. u. Hydrogeograph. i. (1908) pp. 533-52.

and the resulting conjugation of algæ, may, perhaps, be thus explained : the phanerogams require much nitrogen, as does also *Spirogyra* in consequence of its quick growth, also greater denitrification takes place.

Fresh-water Algæ from the Malay Region.*—C. Bernard publishes a list of unicellular fresh-water algæ collected at various stations round Batavia, at Singapore, Johore, New Guinea, and including a few species from Japan. After giving a list of bibliography, the author enumerates in tabular form the algæ of the present list and the previous records of other authors, giving locality and reference to the published record. The species of the new collections are then treated separately and are shortly described in critical notes. Seventeen new species are described for the first time, and one of these is the type of a new genus, *Spinoclosterium*, an ally of *Closterium*. Most of the novelties are desmids. One or more figures are given of every species recorded, in order that there should be no mistake as to its identity.

Some Fresh-water Algæ of Fiji.†—W. West contributes a list of twenty-five fresh-water algæ to L. S. Gibbs's account of the montane flora of Fiji. There are seven Chlorophyceæ, twelve Bacillariaceæ, and six Myxophyceæ; and they were gathered at Nadarivatu (2700 ft.), at the base of Koro Levu (500 ft.), or in the hot springs (59°) of Tavua (50 ft.).

Interesting Diatom near Hull.‡—R. H. Philip writes a short note on *Amphiproron constricta* Ehr. (*Stauronella constricta* Mereschkowsky), which he has found in one of the original localities, Marfleet, near Hull. Until it was made the type of a new genus it had been placed in three different genera on account of its anomalous structure. In the fifties it was recorded by George Norman as being very common in brackish water, but apparently it is very little known by leading diatomists of the present day. The author gives figures of it in the present note.

Biddulphia sinensis.§—C. H. Ostenfeld writes on the immigration of *Biddulphia sinensis* Grev. and its occurrence in the North Sea during 1903-7, and on its use for the study of the direction and rate of flow of the currents. *B. sinensis* is frequent in the Red Sea and the Gulf of Siam, and is regarded as an Indo-Pacific neritic form of the tropical and sub-tropical coasts. The author shows the specific differences between this species and its nearest allies, especially *B. mobiliensis* and *B. regia*; and then treats of its geographical distribution, mentioning its occurrence on the Guinea coast in the Atlantic. The question of its presence in the North Sea is then discussed, and its relationship to the temperature of the water and to the salinity. The presence or absence of *B. sinensis* at different periods in the North Sea is important as an indication of the direction and rate of flow of the ocean currents.

* Départ. Agricult. Indes-Néerlandais. Buitenzorg, 1909, 94 pp. 6 pls.

† Journ. Linn. Soc., xxxix. (1909) pp. 200-2.

‡ Naturalist, No. 634 (1909) pp. 376-7.

§ Medd. Kommissionen f. Havunders. Ser. Plankton i. 6 (1908) 44 pp. (4 charts and 5 text-figs.).

Diatomaceous Dust on the Behring Sea Ice-floes.*—E. M. Kindle describes his investigations of the diatomaceous dust found by him on the ice-floes off the south-west coast of Nunivak Island in June 1908. The ice cakes comprising the floes were more or less discoloured by dust or dirt. Some of the dust was found to be of volcanic origin, and in this, as well as in the other grey non-volcanic dust, were found considerable numbers of marine diatoms. A list of fifteen species is given, found in samples collected about 30 miles north-west of Cape Romanzof, and named by Dr. Mann. Diatoms have not before been observed on the Behring Sea ice, and the recorded occurrences of these organisms on floating ice elsewhere are not numerous. Some have been recorded by Nansen and Vanhoffen. The nearest locality to Behring Sea from which diatoms have been found on floe ice is near Cape Wankerema, west of Behring Strait about 200 miles. The author proceeds to compare the list of species from the Behring Sea with those recorded by the 'Vega' and the 'Fram,' and finds that the Behring Sea flora is related to that of the Pacific, and not at all to that of the Polar Sea. The fact that the diatoms of Cape Wankerema, about 400 miles from Cape Romanzoff, bear the closest resemblance to the diatoms of the east coast of Greenland, and the almost complete unlikeness between the Wankerema and Behring Sea floras, affords convincing evidence that no definite marine current connects the two areas which could carry the Wankerema flora southward or the Behring Sea flora north-westward. On the other hand, the close resemblance of the Behring Sea ice diatoms to the Pacific flora, which is shown by more than nine species common to the two, indicates a close relationship through marine currents with the Pacific Ocean. Dall's conclusions regarding the movement of water in the southern part of Behring Sea corresponds with the evidence of the diatoms in this respect. The author quotes from Dall's report on the U.S. Coast and Geodetic Survey for 1880.

Physiology of Diatoms.†—O. Richter has continued his studies on the physiology of diatoms, and has succeeded in cultivating a colourless marine species, namely, *Nitzschia putrida*. He gives an account of his methods. *N. putrida* is typically saprophytic, and assimilates leucine, asparagin, pepton, and albumen; and when suitable sources of carbon are present, also the inorganically combined nitrogen of nitrates and ammonium compounds. Negative auxanograms can be raised by the help of substances of an acid reaction. In the course of generations the normal power of movement becomes lost. The species appears to be extraordinarily capable of variation. This paper is so full of information that it must be studied in the original.

Halopteris scoparia and Sphacelaria radicans.‡—C. Sauvageau has described in previous papers the peculiar development of *Cladostephus verticillatus*, and the manner in which the young plant passes through stages resembling *Sphacelaria* and *Halopteris* before taking on the characters of *Cladostephus*. He has also stated that there is a similar

* Amer. Journ. Sci., xxviii. (1909) pp. 175-9 (1 fig.).

† Denkschr. k. Akad. Wiss. Wien, lxxxiv. (1909) pp. 656-772 (pls. and text-figs.).

‡ Journ. de Bot., ser. 2, ii. (1909) 27 pp.

development in *Halopteris scoparia*, but he has not described the process in detail. In the present paper he describes and figures all the stages of growth of *H. scoparia*, in which species the process of development is quite different from that of *Cladostephus*. In *Halopteris* the successive filaments, instead of appearing independently from one another, grow one on the other. This is described in detail. He finds that plantlets arising from rhizoids which are given off by gemmæ are themselves a kind of gemmæ, and resemble a fragment detached from the plant-mother. On the other hand, the plantlets which result from germination possess an indirect development, which represents probably the different phylogenetic stages.

The author has further made a special study of *Sphacelaria radicans*, in which he finds that the ramification is exclusively adventive and of perieystic origin. He considers that *S. radicans* probably figures among the ancestors of *Halopteris*, but is separated from them by intermediates which have disappeared or of which we know nothing. The perieystic origin of the rhizoids and of the adventive shoots, the presence of certain holoblastic branches, and the germination of the hairs, indicate a closer connection between *S. radicans* and the Holoblasteæ than between it and the Sphacelariæ, which are purely Hemiblasteæ. At the same time, there is a vast difference between the disposition of the sporangia of *S. radicans* and those of *Halopteris*. The author then discusses other alliances of *S. radicans*.

Colpomenia sinuosa.*—C. Sauvageau adds a further note to his information concerning this alga. During a stay at the village of St. Denis on the Ile d'Oleron he found specimens of *C. sinuosa*, growing principally on *Halopithys*. Its presence there constitutes a danger to the oyster-culture of the Marennes. In a footnote the author comments on the various hosts on which the species has been found growing.

Mucilage-glands of Undaria.†—K. Yendo has discovered a mucilage-gland on the blade of *Undaria pinnatifida* var. *distans*, and has made a minute study of its structure. The glands vary in size and shape according to their stage of development and position in a pinnule. Very few, if any, occur in the stem of rachis, and none were detected in the rhizines or sporophylls. Such glands have never been recorded in members of the Laminariaceæ other than Japanese, and they are only now described in detail for the first time. Okamura records minute dark dots which are thickly scattered over both surfaces of the lamina of *Undariopsis Peterseniana* Miy. and Okam., and similar bodies have been seen by Prof. Miyabe in *Undaria pinnatifida*, and by the author of the present paper in *Hirome undarioïdes*. Whether all these bodies on the other species are also mucilage-glands of the same sort the author is unable to say, since they were seen on dried material. After describing his investigation in detail, Yendo draws up the following summary:—(1) *Undaria* has numerous glandular cells scattered in the lamina; (2) as a rule, each glandular cell originates from a single cortical cell which is in contact with the epidermal layer; (3) the epidermal cell

* C.R. Soc. Biol. Bordeaux, lxvi. (1909) pp. 805-7.

† Ann. Bot., xxiii. (1909) pp. 613-21 (1 pl.).

upon a glandular cell degenerates as the latter develops, leaving a membranous coating over the gland; (4) the function of the gland is possibly to secrete a mucilaginous substance; (5) the glands found in the lamina of *Hirone* and *Undariopsis* will probably prove to be similar to those of *Undaria* in their mode of development and function.

Cytology of *Cutleria* and *Aglaozonia*.*—S. Yamanouchi, in a preliminary note, gives a brief account of his cytological studies of *Cutleria multifida* and *Aglaozonia reptans*. Of the former species he describes the gametogenesis, the fertilisation and germination, and of the latter, the zoosporogenesis. Finally, he summarises his results as follows:—1. The nucleus of both male and female plants of *Cutleria multifida* contains 24 chromosomes; and the male and female gametes produced contain the same number. 2. In the union of gametes the number is doubled, and 48 chromosomes appear in the sporelings, which develop into the *Aglaozonia* form of *Cutleria*. Therefore it is evident that the individual bearing the name of *C. multifida* represents the gametophytic phase of the species, 24 being the gametophytic number of chromosomes; and the *Aglaozonia* form of *Cutleria* represents the sporophytic phase of the species, 48 being the sporophytic number. 3. *Aglaozonia reptans* contains 48 chromosomes, and the number is reduced in zoospore formation, the zoospore containing 24 chromosomes. The zoospore, with the reduced number of chromosomes, germinates without conjugation. Although the nuclear details of the sporelings of *A. reptans* have not yet been followed, it seems evident that *A. reptans* represents the sporophytic phase of the individual whose gametophytic and sporophytic numbers of chromosomes are respectively 24 and 48. Probably *A. reptans*, as it occurs in nature, is identical with the *Aglaozonia* form of *Cutleria multifida* which he has grown under culture, and is now determined to be the sporophytic phase of the species.

Oospheres in *Sargassum*.†—M. Tahara writes a preliminary note on the periodical liberation of the oospheres in *Sargassum*, which he has observed at the Misaki Marine Station. The species studied was *S. euerve*, which is very common in the vicinity, and often forms a considerable mass. Its fruiting season begins at the beginning of December and continues probably till the end of April. Details are given of the observations made, and the results are shown in a short summary. 1. Liberation of oospheres in *Sargassum* takes place simultaneously, not only for a given plant, but also for all the plants of the locality. 2. This simultaneous liberation proceeds in fortnightly crops on a particular day with a fixed interval after the highest spring tide; interval varies, however, in different species. 3. The oospheres in one and the same receptacle are not discharged at one time, but in two or three successive fortnightly crops.

West Indian Floridææ.‡—F. Börgesen describes some new species of Floridææ collected in the sea around the Danish West Indies, and

* Bot. Gaz., xlvi. (1909) pp. 380-6.

† Bot. Mag. Tokyo, xxiii. (1909) pp. 151-3.

‡ Bot. Tidsskrift, xxx. (1903) 19 pp. (tabs. and figs. in text).

gives remarks on other species already known. The new species belong to *Chantransia*, *Nemalion*, *Cullithamnion*, *Scirospora*, and a new variety to *Spermothamnion investiens*. All the species dealt with are figured.

Fresh-water Species of Chantransia.—F. Brand* publishes a detailed treatment of the fresh-water species of *Chantransia*. His paper opens with a short historical summary of the work of previous authors and their views on the limits of the genus. Then, having put aside the marine forms, he discusses the two groups of fresh-water species, one of which consists of forms of other Florideæ, and the other of independent species. All these forms and species have been carefully investigated by the author and all the different characters examined anew. The connection between the forms of *Chantransia* and the genera *Lemanea*, *Batrachospermum*, *Thorea*, and *Tuomeya* is discussed, and the author is of opinion that the *Chantransia* stage of these algæ is rather the result of adverse conditions than, as has been suggested, an exuberance of growth. He likens it to the deep-water leaves of *Sagittaria*, and points out how this theory would account for the fact that one *Chantransia*, *C. chalybea*, may be connected with no less than eight different species of *Batrachospermum*. *Batrachospermum* is, in itself, so variable, that the author has never been able entirely to fit in his finds with any of the species described by Sirodot. An error, which has been perpetuated by De Toni,† is here exposed, namely, the placing of *Chantransia violacea* as a *Chantransia*-form of *Lemanea*. *C. violacea* is an independent species, though it is frequently found growing epiphytically on *Lemanea*. The author discusses the independent *Chantransia* forms, and clears up difficulties which have long troubled students of the genus. Finally he gives a short systematic synopsis of the genus, dealing only with hydrophilous species. References, synonyms, and short descriptions are given. A sub-genus, *Pseudochantransia*, includes the species which are only a stage in the life-history of other algæ; and this sub-genus is divided into sections according to the genus of which the *Chantransia* forms a part (1) *Pseudochantransia Lemaneæ*; (2) *P. Batrachospermi*; (3) *P. Thoreæ*; and (4) *P. Tuomeyæ*. This paper clears up many difficulties, and since every point has been personally verified by the author himself, it forms a most valuable addition to algological literature.

Griffithsia Bornetiana.‡—I. F. Lewis has made a very complete study of the life-history of *Griffithsia Bornetiana*. It occurs commonly from northern Massachusetts south to Long Island Sound, and has been recorded from New Jersey. In all plants examined, with two exceptions, the antheridia, cystocarps and tetraspores are borne on separate individuals. The spores develop quite rapidly in the open; indeed, bits of cotton cloth, tied to piles near mature plants, showed in two weeks' time sexual plants with ripe antheridia and carpospores, and tetrasporic plants with mature spores. The tetrasporic plants are always more abundant as well as on an average larger than sexual plants. After a few remarks on the methods of fixing employed in his work, the author

* Hedwigia, xlix. (1909) pp. 107-18.

† Sylloge, iv. p. 1866.

‡ Ann. Bot., xxiii. (1909) pp. 639-90 (5 pls. and 2 figs. in text).

describes fully the vegetative characters of the thallus, with special regard to the nuclei; and he compares these bodies with those of *Polysiphonia* and *Nemalion*, the nuclei of which have been carefully studied. Two methods of cell-division are described; the nuclei appear to have no part in the process. Branched hairs are frequently borne on the upper borders of the young cells, the function of which is unknown; they probably perform the functions of absorption and respiration. Sexual and asexual reproduction are very fully discussed, especially with regard to nuclear division, and the behaviour of the tetraspore-mother-cells is compared in tabular form with those of *Corallina* and *Polysiphonia*. One point is emphasised by this comparison, namely, that at a critical stage in the history of rather closely related members (*Polysiphonia* and *Griffithsia*) of a highly specialised group, the phenomena are of a most varied nature. During the period of synapsis, and up to the time of the formation of the chromosomes, the cytological events in *Polysiphonia* are more like those in *Lilium* than those in *Griffithsia* or *Corallina*. From this and other facts, the author concludes that cytological phenomena cannot be considered trustworthy guides to relationships. The other points dealt with are tetraspore-like structures on sexual plants, vegetative multiplication, and germination of spores. In a final discussion of results the author states that (1) there is in *Griffithsia* an antithetic alternation of generations, the gametophyte being represented by the sexual plants, the sporophyte by the sporogenous cells of the cystocarp; (2) in addition to this, there is a regular succession of tetrasporic individuals and sexual individuals. The tetrasporic individuals resemble the sporophyte in number of chromosomes; they resemble the gametophyte in morphological differentiation. They are to be considered as a phase of an homologous alternation of generations, not the equivalent, wholly or in part, of the sporophyte of Archegoniales.

Corallinaceæ.*—M. Foslie published before his lamented death several papers on this subject. He describes new species of *Lithothamnion*, *Goniolithon*, and *Litholepis* from various parts of the world, some of which had been previously described as forms by himself in earlier writings.

He also makes a new subgenus of *Melobesia*, which he calls *Pliostroma*; it includes five species, four of which had been previously placed by the author in *Lithophyllum*, sub-genus *Carpolithon*. *Pliostroma* is characterised by having a thallus composed of 5–12 layers of cells in the part containing the conceptacles, and forms a link between the genera *Melobesia* and *Lithophyllum*.

In another paper,† a continuation of Algological Notes, and constituting the sixth part of the series, a considerable number of diagnoses are published, including species of *Lithothamnion*, *Archaeolithothamnion*, *Goniolithon*, *Lithophyllum*, and *Mastophora*, some new to science. These are followed by systematic remarks on several genera. Six sub-genera are raised to the rank of genera. Unfortunately the whole paper is in Norwegian.

In a short note the author describes two fossil calcareous algæ

* Kgl. Norsk. Vidensk. Selsk. Skrift., 1908, Nos. 11, 12.

† Op. cit., 1909, Nos. 1, 2.

collected by Munier-Chalmas at Namur and preserved in Mons. Boret's herbarium. The material has been known as *Lithothamnion marmoreum*. Foslie has, however, found in the specimen two species, one of which he describes as *Archæolithothamnion marmoreum* and the other as *Lithophyllum (?) belgicum*. The latter is without conceptacles, but it approaches *Lithophyllum* in its structure. The geological period of these two species is unknown.

Finland Algæ.*—E. Hayrén gives a short list of algæ from the west coast of Finland, in the neighbourhood of Björneborg. The list consists of 26 species, of which 8 are Chlorophyceæ, 10 Characeæ, 5 Phæophyceæ, and 3 Rhodophyceæ. They constitute the first records from that coast.

EDWARDS, ARTHUR M.—**Development of the Bacillaria from an Amœboid Form, and formation of that Amœboid Form by Energenesis.**

[An extraordinary and somewhat egotistical communication.]

Nuov. Notar., xx. (1909) pp. 136-40.

MAZZA, A.—**Saggio di Algologia Oceanica.** (Notes on marine algology.)

[A continuation of the genera of Rhodomeleæ.]

Tom. cit., pp. 115-35.

SAUVAGEAU, C.—**Lettre ouvert à M. le Professeur J. B. De Toni au sujet des huitres de Marennes et de la Diatomée bleue.** (Open letter to Professor De Toni on the subject of the oysters of Marennes and of the blue diatom).

Bordeaux: A. Destout, 1909, 24 pp.

SVEDELIUS, N.—**Frans Reinhold Kjellman.**

[A biographical notice.]

Ber. Deutsch. Bot. Gesell., xxvii (1908) pp. (55)-(75).

TURNER, C.—**Desmids.**

[A simple account of desmids in popular language.]

Manchester Micr. Soc., Ann. Rep. and Trans., 1909, pp. 55-63.

WEST, W. & G. S.—**The Phytoplankton of the English Lake District.**

[The authors continue their account of the desmids, and give the Bacillariæ and Myxophyceæ of the district.]

Naturalist, No. 631 (Aug. 1909) pp. 287-92 (figs. in text).

Fungi.

(By A. LORRAIN SMITH, F.L.S.)

Rhizopus Batatas, a New Koji Fungus.†—The preparation of Koji by the aid of a species of *Aspergillus* was affirmed by K. Saito, who also found *Rhizopus chinensis* Saito in the material, and judged that the latter took little part in fermentation. The fermenting agents have been re-examined by R. Nakazawa, who affirms the importance of *Aspergillus*, but claims to have discovered a new *Rhizopus* which also aids in fermentation: he has named it *R. Batatas*. It possesses larger sporangia and spores than the species recorded by Saito, but differs more especially in its power to ferment in pure dextrose, maltose, saccharose, and lactose.

Evolution of the Lower Fungi.‡—G. F. Atkinson has discussed a series of problems in this connection. He gives the views held by various writers, Pringsheim, De Bary, Brefeld, Dangeard, and others;

* Medd. Soc. Fauna et Flora Fennica, xxv. (1909) pp. 108-19.

† Centralbl. Bakt., xxiv. (1909) pp. 482-7 (2 pls.).

‡ Ann. Mycol., vii. (1909) pp. 441-72 (20 figs.).

he describes the life-history of a number of forms, and then sets down his own conclusions. He finds a natural series from the Chytridiales showing progressive evolution of the vegetative body and sexual process up to the Oomycetes and Zygomycetes. He notes the double swarming of the zoospores, reaching its highest development in Saprolegniaceæ, and proliferation of the sporangia, both phenomena unknown in algæ. These facts, he holds, point to the origin of the lower fungi from unicellular organisms at the level of the Protomastignieæ or Protococcoideæ, either colourless or chlorophyll-bearing, rather than from confervoid or siphonaceous algæ. Other reasons are adduced to support this view, as, for instance, the form and ciliation of the zoospores in the Ancylistales and Oomycetes, which are totally different in the Chlorophyceæ, as represented by *Edogonium* and *Vaucheria*. There is also the difference in fertilisation between these different forms, accomplished in the fungi by means of an antheridial tube, in the algæ by ciliate or biciliate sperms. Atkinson does not consider the number of cilia of the zoospores a very distinctive character, as both kinds of zoospore may occur in the same zoosporangium.

The writer does not hold with the theory that parasitism has a debasing influence, considering the group of fungi as a whole. There is distinct progression of development from the Chytridiales to the Oomycetes, all of them being parasitic. Again, the Ascomycetes and Basidiomycetes show extensive development of the fruit-bodies undeterred by the influences of saprophytism or parasitism.

Development of Fungi on Fatty Substances.*—It has been generally held that fungi do not grow on fats. A. Roussy has made experiments to test the validity of this statement. He found that fungi such as *Rhizopus nigricans*, *Phycomyces nitens*, etc., grew best on a sugar solution when there was only a small percentage of sugar. He applied the same test to fats, using only small quantities along with Raulin gelatin, and he obtained successful cultures.

Leptolegnia from North Carolina.†—W. C. Coker has collected this rare fungus from a jar containing algæ, and has cultivated it over a year. It was first discovered and described by De Bary from mountain lakes in Germany in 1881 and 1884, and Coker tells us it has not been recorded since. The development of the fungus was followed, and various details, omitted by De Bary, have been noted.

Fungus Parasites of Algæ.‡—The species described belong to the Chytridiales, and are parasitic on filamentous green algæ. They were collected by G. F. Atkinson in the vicinity of Ithaca. He recalls his note on the escaping zoospores of *Rhizophidium globosum*, which come to rest on the sporangial wall, and put out pseudopod-like extensions of protoplasm that feel for the opening. The same phenomenon was observed in *R. brevipes* sp. n., parasitic on *Spirogyra varians*: if the zoospore failed to find the opening with its pseudopodia, it came to rest

* Comptes Rendus, cxlix. (1909) pp. 482-4.

† Mycologia, l. (1909) pp. 262-4 (1 pl.).

‡ Bot. Gaz., xlvi. (1909) pp. 321-38 (8 figs.).

for a while, returned again, and repeated the process. The emptying of a sporangium was watched till two zoospores only were left; these, having failed to escape, put out a germ-tube some 15–20 μ long, which penetrated the wall of the zoosporangium; as it failed to find nourishment the tube was withdrawn, the zoospore moved to the other side of the sporangium and repeated the process, after which it degenerated. Other species recorded are *Rhizophidium sphaerocarpum* on *Mougeotia parvula*, *Rhizophidium minutum* sp.n. on *Spirogyra varians*, *Lagenidium Rabenhorstii* on *Spirogyra* sp.n., *Lagenidium americanum* sp.n. in zygospores of *Spirogyra*; *Phlyctochytrium planicorne* sp.n. also on *Spirogyra varians*, and *Phlyctochytrium equale* on *Spirogyra insignis*. A description is given of these plants, their development, and the formation and escape of the zoospores, with the effect on the host-plant. Five other species are listed, which were studied only for identification.

Cytology of the Ascus.—This subject has been investigated by W. E. Brooks* and H. C. I. Fraser in three different Ascomycetes—*Humaria granulata*, *Ascobolus furfuraceus*, and *Lachnea stercorea*. These forms were selected, as in each of them fertilisation of a reduced type, represented by fusion of nuclei in the ascogonium, had been observed, with a second fusion in the ascus. Methods of staining, etc., are detailed. In the first of the fungi examined, four chromosomes were observed in the ascogenous hyphae, but they were found to be four bivalent chromosomes equivalent to the eight chromosomes of other forms. In the three divisions in the ascus to form the eight spores, a somewhat similar process was observable in the different fungi. The first division was heterotypic; the second division was homotypic, but a second reduction took place at the third division. After brachymeiosis was complete, there were four chromosomes in *Humaria* and *Ascobolus*, and two in *Lachnea*. In the first ascus division of *Lachnea* two long chromosomes and two short ones were constantly recognised; after the second reduction there was one long and one short, each type of chromosome probably forming the physical basis of a different set of characters. The writers discuss at some length the conjugation of the premeiotic chromosomes to form the gemini of the heterotypic prophase; the formation of the spore membrane is touched on.

Development of Monascus.† — Schikorra designates the fungus which he examined, *Monascus x*, a new species. He describes the formation of conidia from the tips of the hyphae, while on other hyphae were formed the antheridia and ascogonia with trichogyne. The antheridium is cut off from the top of a hypha rich in contents, and is always multinucleate; the cell beneath the antheridium grows out and forms an ascogonium with an upper cell, the trichogyne, both also multinucleate; copulation takes place between the trichogyne and antheridium, the nuclei of the former degenerate while those of the latter pass over through the trichogyne and penetrate the ascogonium, the dividing wall partly breaking down. Fusion does not take place, but

* Ann. Bot., xxiii. (1909) pp. 537–49 (2 pls.).

† Zeitschr. Bot., l. (1909) pp. 379–410 (1 pl.). See also Bot. Centralbl., cxi. (1909) pp. 447–8.

the nuclei pair and pass into the ascogonial hyphæ. The nuclei undergo conjugate division; finally two nuclei fuse to form the primary ascus nucleus. A peridium is formed by the branching of the stalk-cells of antheridium and ascogonium. The author places *Monascus* in the Plectascineæ.

Species of *Taphrina* on *Betula*.*—O. Juel gives an account of ten species of this fungus that occur on *Betulæ*. Some of them give rise to witches' brooms; others form spots on leaves, and a third section cause deformations either of the leaves or the twigs. One species, *Taphrina nana*, forms small witches' brooms on *Betula nana*, and is only known in northern lands.

***Oidiopsis taurica*.**†—E. Foex is of opinion that the development of the mycelium of the fungus, whether external or internal, depends on the structure of the host leaves: if they are hairy, then the external mycelium is abundant, as in *Mercurialis tomentosa* and *Phlomis herba-venti*. In *Onobrychis sativa*, which bears only simple and slender hairs, the mycelium is developed within the leaf, sparing always the epidermis, but sending haustoria into the mesophyll cells; the conidiophores pass out through the stomata. René Maire considered that the endophytic condition of this fungus was an adaptation to dry atmospheric conditions, but in the case of *Onobrychis* it has passed to a non-xerophilous plant.

Notes on Phylogenesis in Yeasts.‡—Guilliermond repeats his previous statements of the relation between Endomycetes and Saccharomycetes, the latter having, he considers, been derived from an ancestor closely related to *Endomyces fibuliger*. He now finds that *Saccharomycopsis capsularis* is closely related to *Endomyces fibuliger*, and he proposes to place it in the same genus, *Endomyces*. He traces the connection of the various species of *Endomyces* with each other, and with the true yeasts.

Hyphomycetes.§—G. Lindau is nearing the end of the volume on Hyphomycetes. The fascicle last issued deals with, among others, such obscure genera as *Hymenella*, *Sclerococcum*, *Epiclinium*, and *Cheiromyces*. For the sake of completeness, the author has included *Sclerotium* as a genus, and he gives the published diagnoses of a large number of species, though many of those described, such as ergot, have been satisfactorily identified with a more definite fruiting form. *Ectostroma* is another equally unsatisfactory genus, being merely blackish spots in which mycelium grows. Lindau remarks that the naming of such growth is worthless so long as no more definite fruit-form is developed.

***Ædocephalum glomerulosum*, the Conidial Form of *Pyronema omphalodes*.**||—Ernest W. Schmidt found the hyphomycetous fungus

* Svensk. Bot. Tidsskr., iii. (1909) pp. 183-91 (3 pls). See also Bot. Zeit., lxxvii. (1909) p. 287.

† Ann. Ecole Nat. Agric. Montpellier, n.s. viii. (1909) 12 pp., 5 pls. See also Bot. Centralbl., cxi. (1909) p. 565.

‡ Centralbl. Bakt., xxix. (1909) pp. 480-2.

§ Rabenhorst's Kryptogamen-Flora, 9te Abt., Lief. 115 (Leipzig, 1909) pp. 625-88.

|| Centralbl. Bakt., xxv. (1909) pp. 60-5.

Edocephalum on cotton wool used as a stopper in connection with water cultures of plants. Not only the cotton wool but the culture plants themselves were soon covered with a growth of the fungus. In the space of two weeks *Edocephalum* died down and was succeeded by tiny red cushion-like growths, which increased, and finally formed into plants of *Pyronema*. The author reviews work done on the germination of *Pyronema* ascospores, and cites the case of *Peziza vesiculosa*, of which Brefeld determined the conidial form to be an *Edocephalum*. Schmidt also germinated *Pyronema* ascospores. These were difficult to obtain without bacteria that destroyed the cultures until he employed the dilution methods, so useful in bacterial cultures. From spores so obtained he reproduced a vigorous growth of *Edocephalum*. The colour substance is also discussed, and the physiological properties of the fungus.

Uredineæ.*—J. C. Arthur gives some notes on rusts that may prove of service to the general botanist. An important part of field work is to re-visit the locality where any rust has been found and see if any further stage has developed on the original or other hosts. Another task prescribed is to take the rust to a healthy plant of the second host in some other locality and leave it there, then to note if infection has taken place. Failure may mean some flaw in the experiment, or it may indicate that the true second host has not been found.

Frank D. Kern † discusses the importance of Timothy rust, which seems to be increasing; an account of its identity and nature are given.

Aaron G. Johnson ‡ gives an account of heterecious rusts in Indiana in tables showing those that have been co-related and their several hosts identified. The life-histories of thirty-four species of rusts in Indiana are known, though the æcidia of nine of these do not occur in the State.

J. C. Arthur § publishes the Cultures of Uredineæ in 1908, the article forming the ninth of a series of reports on the culture of plant rusts. Grass and cedar rusts figure largely in the report. Collecting trips were made and accounts are given of much good work done. A list of experiments is given which gave only negative results. Successful results are chronicled in twenty-three cases; a number of new species are described with their cultural records.

Smut Infection of Wheat and Barley.—Brefeld and Hecke made the discovery simultaneously some years ago that when the oat plant was infected by smuts in the seedling stage, wheat and barley were attacked by the flower. Wilhelm Lang has taken up the subject and has examined the infected seed. He finds that the spore on germination penetrates the ovary of the host; by following the track of the pollen tube, it follows the line of least resistance, and its path is made still easier by the withering of the stigma after fertilisation. Lang did not find that hyphæ penetrated the endosperm; they were always

* Proc. Ind. Acad. Sci., 1908, p. 83.

† Tom. cit., pp. 87-94.

‡ Centralbl. Bakt., xxv. (1909) pp. 86-101 (1 pl. and 2 figs.).

§ Tom. cit., p. 85.

§ Mycologia, 1. (1909) pp. 225-56.

confined to the embryo, and passed a resting stage in a symbiotic relationship with the grain, no deleterious parasitic action having taken place. Other questions are discussed, such as the mycoplasma theory, the liability to infection, effect of weather, etc.

Exobasidium on Azalea.—M. Raciborski* has described the growth of *Azalea pontica* in the Sandomerer wood on the Caucasus. On the drifting sand heaps *Azalea* forms thick clumps of bush along with other plants, of which he gives a list. The leaves of the shrub are thickly infested with the gall-like *Exobasidium discoideum*. It appears on the under side of the leaves, at first greenish-white, becoming orange-red where exposed to light, and finally primrose, with the coating of basidiospores; these are at first linear, slightly bent, and 1-celled, but before germination they become 1-3-septate.

R. Laubert † describes the same disease on *Azalea*, in Germany: he compares it with allied species on *Vaccinium*, *Rhododendron*, and *Azalea*, and gives advice as to the best methods of checking the disease. He specially advises cutting away and burning the diseased parts.

Podoscypha undulata. ‡—René Maire received a specimen of this fungus from the Vosges, and as it is a rare and imperfectly known plant, he takes occasion to give a full description and figures, and to rectify various errors of nomenclature. It is a small fungus with a cup-shaped pileus, the under side bearing the hymenium. Cystidia are numerous, spores colourless, smooth, and very small.

Notes on the Larger Fungi.—G. F. Atkinson § describes at considerable length a new *Amanita* from the high Sierras and the Coast Range of California. It attains to a large size and is covered by a white tough skin, the calyptra of the volva.

F. G. Kohe || describes a case of an alga living on a fungus and the changes induced thereby. The fungus was almost certainly *Russula fragilis*; the alga, *Raphidium* (Pleurococcaceæ). The *Russula* was considerably dwarfed and the gills undeveloped where the alga had spread. Kohe does not recognise any advantage to the fungus in this symbiosis, but the alga which received shelter and moisture grew vigorously and abundantly.

W. A. Merrill ¶ gives a black and white plate of illustrations of large fungi, most of them puff-balls; these he specially recommends for the table, being easily identified fungi, and none of them being poisonous. They should be gathered when young, before the spores have formed. Several of the fungi are figured and described.

Lars Romell ** remarks on the cases where fungi, that usually grow on coniferous trees, may be found on deciduous trees, and *vice versa*. Among such he cites *Dædalea unicolor*, a parasite of deciduous wood, but found by him on *Pinus Abies*; *Polyporus zonatus* and *P. adustus*,

* Bull. Acad. Sci. Cracovie, 1909, pp. 385-91 (2 figs.).

† Handelsbl. Gartenbau, xxiv. (1909) pp. 466-8. See also Bot. Zeit., lxxvii. (1909) p. 235.

‡ Ann. Mycol., vii. (1909) pp. 426-31 (2 figs.).

§ Bot. Gaz., xlviii. (1909) pp. 283-93 (8 figs.).

|| Beih. Bot. Centrall., xxiv. (1909) pp. 427-30.

¶ Mycologia, l. (1909) pp. 257-61 (1 pl.).

** Tom. cit., pp. 265-7.

also occasionally found on *Pinus Abies*; *Polyporus giganteus* he has collected on an oak and on a stump of *Pinus silvestris*. A number of other cases are given, and the list is still incomplete.

Deformation of the Egg of *Mutinus caninus*.*—Ch. van Bambeke passes in review the different cases of teratology noted among the Phallaceæ, and then describes an interesting example discovered by him in *Mutinus caninus* when cutting microscopic sections. The outward appearance of the egg was normal, but it was found that the interior consisted of one principal plant and five others connected with it, and developed successively at its base, presenting a kind of proliferation.

Mushrooms, Edible and otherwise.†—M. E. Hard has published a good-sized volume with this title, very fully illustrated by photographic reproductions, and meant to serve as an introduction to the study of the larger fungi. The habitat and time of growth of each plant is given, also its edibility; and it is hoped that it will assist fungus collectors to become familiar with the common mushrooms of their vicinity. Instruction is given in the last chapter as to the culture of mushrooms, and some simple cooking recipes are added. A glossary and index complete the volume.

Synopsis of Phalloids.‡—C. G. Lloyd has published at intervals his notes on species of Phalloids. In the present pamphlet he gives an account of all the family, with descriptions and photographs of the different species. He includes sixteen genera, one of them new, *Pseudocolus*. His work bears a close relation to that of Ed. Fischer, though he has retained a number of species that Fischer regarded as forms only. The Phalloids are nearly all tropical or sub-tropical plants, only six species having been found in Europe. Lloyd gives a list of synonyms that have been dropped—a very long list. In an appendix is published a note by Ch. Bernard giving a description with two photographs of *Aseroë rubra* var. *Junghuhnii*.

Mycological Fragments.§—Under this title Fr. v. Höhnel continues his studies of fungi, which range over the whole subject. Many of the fungi already described are subjected to criticism, new diagnoses written, and their place in the system rearranged. The author also describes a number of new species collected by him in Java. The new genera recorded are: *Scolecopeltopsis* (Hypocreaceæ), *Phæoisaria* (near to *Isaria* or *Graphium*), *Agyrona* (belonging to the Agyriæ), *Dyctionella* (Saccardiaceæ), *Articularia* (Hyphomycetes), *Tuberculariopsis* (Tuberculariæ). The author gives also a list of Mycomycetes from Java, which includes new genera, *Physarina*, *Diachælla* and *Lepidodermopsis*.

Mycological Notes. No. 33.||—C. G. Lloyd has issued a series of paragraphs on various subjects connected with mycology. He gives a portrait and a written sketch of the late Paul Henning's life and work.

* Ann. Mycol., vii. (1909) pp. 418-25 (3 pls.).

† Ohio Library Co., Columbus, Ohio, xii. and 609 pp. (504 figs.).

‡ Cincinnati, Ohio, 1909, 96 pp., 108 figs. and 1 pl.

§ SB. Akad. Wiss. Wien Math.-Nat. Kl., cxviii. 1 (1909) pp. 275-452 (1 pl. and 35 figs.). See also Ann. Mycol., vii. (1909) pp. 488-9.

|| Cincinnati, Ohio, 1909, pp. 425-44 (11 figs.).

Professor Hard's book on fungi is strongly recommended by him as a good popular presentation of a difficult subject. A description is given of the ejection of the peridioles in *Sphaerobolus* and the re-discovery of *Boristella palulosa* is chronicled. Lloyd also gives an account of a new *Broomeia*, and discusses the differences between *Fomes applanatus* and *F. reniformis*, an American species. A closely allied species, *F. leucophæus*, is common in the United States and rare in Europe.

Freezing of Filamentous Fungi.*—Hugo Bartetzko has carried out a long series of experiments on the subject with a view to studying the whole subject of injury to plants by extreme cold. Filamentous fungi, such as *Penicillium glaucum*, *Botrytis cinerea*, *Phycomyces nitens*, and *Aspergillus niger*, were chosen for experiment and grown on suitable media. He found that the different fungi reacted differently to cold, that they could all withstand low temperatures but died off if the culture solution was frozen. If the period of cold were prolonged the plants eventually were killed, though this power of resistance was heightened the more concentrated the culture solution. Death by freezing is not simply due to withdrawal of water, because the point of freezing may be at a temperature higher than that at which water is withdrawn in any considerable quantity. The phase of development of the fungus is of considerable importance in the moment of freezing.

Termites and Fungus-culture.†—K. Escherich contributes a study of the fungus gardens of the white ants. These gardens are constructions of various sizes, and are traversed by gangways in which the fungus is cultivated; the larvæ of the ants are kept in the neighbourhood of the fungus and live on it. The fungus itself is clear or dark brown coloured, and forms little pustules, all closely congregate; the substratum on which the fungus grows is of wood, or occasionally of leaves. On the outside of the nests very frequently an Agaric (*Volvaria eurrhiza*) is found, especially after rain. If a portion of a nest is kept under a bell-jar the stomata of a *Xylaria* make their appearance, so the fungus garden is not a pure culture of *Volvaria* alone. The latter has never been found apart from termite nests.

Genera of Fungi.‡—F. E. Clements has compiled, in key form, the genera of fungi, so far as known, taken from Saccardo's *Sylloge Fungorum*, Thaxter's *Laboulbeniaceæ*, and Zahlbruckner's *Lichens* in Engler and Prantl's *Pflanzenfamilien*. He also adds explanations of terms used by Saccardo, list of genera, and a very full index.

Diseases of Plants.§—A. D. Selby and T. J. Manns describe a new disease of cereals caused by a fungus, *Colletotrichum cereale* sp. n. It attacks the spikes, culms, and sheaths of various grasses; on cereals the attacks take place as the plant ripens, causing a shrivelling of the grain.

M. F. Barrus || has studied the dissemination of disease by means

* Jahrb. wiss. Bot., xlvi. (1909) pp. 57-98.

† Biol. Centralbl., xxix. (1909) No. 1. See also Centralbl. Bakt., xxiv. (1909) pp. 591-2.

‡ Minneapolis: H. W. Wilson Co. (1909) 227 pp.

§ Proc. Ind. Acad. Sci., 1908, p. 111.

|| Tom. cit., pp. 113-22 (3 pls.).

of the seeds of the host-plant, and published his research as a thesis presented at Wabash College, Crawfordsville, Indiana. He distinguishes two classes: (1) those which infest the seed internally as in anthracnose of beans, *Ascochyta Pisi* on pea, and some smuts; (2) those diseases where the fungus spore becomes attached to the mature seed externally, as in most of the smuts, in some rusts, etc. Some bacterial diseases are also propagated in this way. Advice is given as to cleansing of seeds.

A disease of melons and cucumbers,* first recorded and described in America, has appeared in Gloucestershire. It is due to a small Ascomycete which attacks and kills the stem and the leaves; these wither and die. Only the conidial (*Ascochyta*) stage has been noticed in England, and it only occurs in hot-houses.

T. Johnson † publishes further observations on *Spongospora Solani*, the powdery potato scab. He has had opportunities of examining Berkeley's *Tubercinia scabies*, formerly considered as a smut, and finds that it is identical with his specimens of *Spongospora*. Potato crops in the Scilly Islands and Cornwall have suffered from the disease this summer, where it appeared in a very destructive form. Johnson describes again the development of the fungus, and proves its identification with the one described by Wallroth in 1842 as *Erysibe subterranea*. Johnson finds that treating scabby tubers for 18 to 20 hours with Bordeaux mixture kills the disease and insures a healthy crop from these tubers.

An account ‡ comes from Kew as to the extent to which the above Potato scab has spread throughout the country. Most of the cases reported are from Scotland, the worst area being the Hebrides. Soil does not seem to be a factor of great importance; the fungus is propagated from diseased tubers. *Rhizoctonia violacea* also attacks potato tubers, and when the mycelium penetrates the tissue it reduces it quickly to a pulp. Another disease, *Hypochnus Solani*, reported from Birkenhead, attacks the haulm just above the ground level. From St. Helen's in Lancashire, cases of potato leaf blotch were sent to be examined. The foliage was attacked by a hyphomycetous fungus, *Sporidesmium Solani* f. *varians*, which forms brown patches on the leaves. Spraying with half strength Bordeaux mixture is recommended, and, in autumn, the burning of all diseased tops. "Sprain" in potato tubers was also investigated. It is accompanied by brown spots in the flesh of the tubers; in some of them mycelium was found. In some cases the brown spotting is an incipient stage of winter-rot.

Sybil Longman § has also been working on potato disease to determine the nature and cause of dry-rot. This is due to *Fusarium Solani*, which spreads more particularly among stored potatoes. It is a true parasite, and if diseased tubers are planted the fungus travels to the shoot, causing them to shrink and die. Longman describes the mycelium as forming pink, white, or buff-coloured mycelium with typical

* Journ. Board Agric., xvi. (1909) pp. 579-80.

† Sci. Proc. Roy. Dublin Soc., xii. (1909) pp. 165-74 (3 pls.).

‡ Journ. Board Agric., xvi. (1909) pp. 642-8 (1 pl.).

§ Journ. Linn. Soc., xxxix. (1909) pp. 120-9 (1 pl.).

Fusarium lunate, septate spores. The older pustules become dark blue at the base, forming a hard dry sclerotium; the upper part turns bright blue, and two different types of spores appear—the first the typical *Fusarium* spores, the second round and pointed spores. No ascus fruit was observed, but the pustules may be regarded as a reduced pycnidial stage. Sterilisation by heat is not possible, as the fungus can resist temperatures that kill the tubers.

Fritz Krause* records a disease of oats in West Prussia due to *Scolecotrichum graminis*. It appeared at first as whitish spots on the leaves, which presently increased in size and became brown; on the white spots, black points appeared, the fructification of the fungus.

E. J. Butler† recognises *Coryneum Mori* as a disease of mulberry in Kashmir, introduced from Japan. The fungus attacks the base of the twigs, and does serious damage to the trees; it develops with great luxuriance on the fallen branches. Several other fungi are given as parasites of the mulberry.

In his yearly report of fungi, G. P. Clinton‡ takes note of several parasitic fungi. *Phytophthora Thalictri* was found in Connecticut on *Thalictrum Polygonum*, also the oospores, a new discovery. Smith and Smorenski had announced the finding of the oospores of *Phytophthora infestans*, but Clinton sees reason to doubt the correctness of this, as culture experiments with the oospores were a failure. The oospores of *P. Phaseoli* were easily grown, and their development is described in detail.

D. Kirchner§ states that the oak mildew is universally prevalent in Würtemberg; it made its first appearance in May, and was at its worst in July and August. The mischief caused is not so great as in France. It has again been demonstrated that the mildew in question is not *Phyllactinia corylea*. Some perithecia of that species found on the oak were accidental.

H. Klebahn|| has published in volume form the results of extended observations of fungus diseases on lilac (*Syringa vulgaris*). This shrub has been extensively cultivated of late years, and, with overcrowding, have arrived the fungus pests. He touches on the animal and bacteria pests, and then passes to parasitic fungi. Among these, there are three of special importance: *Botrytis cinerea* and *Heterosporium Syringæ*, which attack and destroy the leaves, and *Phytophthora Syringæ* sp. n., which causes a disease of the bark and of the buds. Klebahn describes in detail the appearance of the fungus, and the havoc it works in the tissues. He made a series of artificial cultures, and produced abundant oogonia and oospores. Finally by transferring to pure water culture a piece of the mycelium, he was able to develop sporangia and to watch the zoospores escape. He infected successfully twigs of the

* Centralbl. Bakt., xxv. (1909) pp. 102-6 (1 pl.).

† Mem. Dep. Agric. India, Bot., ser. 2, viii. (1909) 18 pp. (4 pls. and 1 fig.). See also Ann. Mycol. vii. (1909) p. 495.

‡ Rep. Conn. Agric. Exper. Stat., xii. (1909) pp. 849-907 (16 pls.). See also Ann. Mycol., vii. (1909) p. 495.

§ Nat. Zeitschr. Landw. Forstw., vii. (1909) pp. 213-17. See also Ann. Mycol., vii. (1909) p. 497.

|| Krankheiten des Flieders. Berlin: Gebr. Borntraeger (1909) 75 pp. (45 figs.)

host-plant with water-containing zoospores, and produced all the symptoms of the disease. The author gives advice as to the stamping out of the disease, which he thinks should be easily done by avoiding all wounding of the bark and, as far as possible, all contact between the young twigs and the soil.

V. Ducomet* gives an account of his research on diseases of cultivated plants. He cites, first of all, a new parasite of rye-grass, *Fusarium loliaceum*, which lives on and destroys the leaves. The author finds it growing in a more sparse manner than is usual with *Fusarium*, but he finds that the two conditions of scattered and compact formation of conidiophores is a growth state, and not a generic difference.

He records a new disease of pine-leaves caused by a minute Ascomycete, *Sphaerella pinifolia* sp. n. It encrusts the needles with brown hyphae, and chokes the stomata: later, the hyphae penetrate the tissues.

A new disease of potatoes has also been discovered by Ducomet, and ascribed by him to a fungus—probably *Vermicularia varians*. The fungus forms minute sclerotia on the tuber: the fungal filaments collect in the superficial tissues, and form hardened surfaces. Notes are also given on the oak mildew. The writer agrees that it cannot be *Microsphaera Alni*, and that it is probably distinct from *Oidium quercinum*.

H. T. Gussow † reports on black-scab of potatoes in Newfoundland. He gives a history of the disease in Europe, describes its appearance, and suggests remedies. He accepts the name given by European mycologists, *Chrysophlyctis endobiotica*.

Root-fungi of Orchids. ‡—Hans Burgeff has studied the fungi that enter into symbiotic relationship with orchid roots, and now publishes the results of his observations and experiments. He discusses the meaning of symbiosis, and combats Elenkin's theory that of the two symbionts one is necessarily living at the expense of the other. The two organisms are really well-balanced in nature: and only when, by some accident, one becomes overweighted, does harm result to one or both of the symbionts.

Burgeff describes the morphology and physiology of the fungi from data gained in his experiments. The fungus does not assimilate free nitrogen, and it is aerobic; formation of spores and sclerotia depend on the concentration of the substratum. In the second part of the work he describes the result of cultures of orchids from seed with and without the fungus symbiont, gives detailed accounts of many of the orchids and the root-fungi, and discusses from every standpoint the value and function of the mycorrhiza.

BERGAMASCI, G.—**Due nuovi miceti per la campania.** (Two new fungi for Italy.)

[*Montagnites Candollei* and *Gyrophragmium Delilei* were found, and are fully described. *Nuovo Giorn. Bot. Ital.*, xxi. (1909) pp. 439-42 (1 pl.).

* Ann. Ecole Nat. Agric. Rennes, ii. (1908) 1909, pp. 1-54 (54 figs.). See also Bot. Centralbl., cxi. (1909) pp. 545-6.

† Dept. Agric. Centr. Exper. Farm, Ottawa, Canada, Bull. No. 63, 8 pp. (2 pls. and 1 fig.). ‡ Jena: Gustav Fischer, 1909, 250 pp. (22 figs.).

- BIGEARD, R., & H. GUILLEMIN—**Flore des Champignons supérieurs de France.** (Flora of the higher fungi of France.)
[An account of the most important edible and poisonous species.]
Chalons-sur-Saône (1909) 600 pp. (56 pls.).
See also *Ann. Mycol.*, vii. (1909) p. 486.
- COLIN, HENRI—**Action toxique der sulfate de cuivre sur le Botrytis cinerea.** (Toxic action of sulphate of copper on *Botrytis cinerea*.)
[Resistance to poison of this fungus is less than that of *Penicillium* and *Aspergillus*. The author failed to localise the effect of the copper.]
Rev. Gén. Bot., xxi. (1909) pp. 289-94.
- GARNIER, R., & AM. LARONDE—**Champignons et Lichens.**
[List of 252 fungi and 112 lichens collected in Haut-Valais.]
Bull. Acad. Int. Geogr. Bot., xvii. (1909) pp. 142-62.
- JAAP, O.—**Zur Flora von Glücksburg.**
[A list of fungi, with several new species.]
Schrift. Nat. Ver. Schleswig-Holstein, xiv. (1909) pp. 296-319.
See also *Ann. Mycol.*, vii. (1909) p. 189.
- KESSLER, H. V.—**Beitrag zur Kenntniss der Pilzflora Dalmatiens.**
[Twenty-two species are described that were found among a collection of lichens.]
Oesterr. Zeitschr., lix. (1909) pp. 275-9, 299-302.
- LEGNÉ, L.—**Catalogue raisonné des Basidiomycetes qui Croissent autour de Mondoubleau.**
[List of 753 Basidiomycetes from near Mondoubleau, in the Département of Loir-et-Cher, La Sarthe, and Eure-et-Loir.]
Bull. Soc. Arch. Sci. litt. Vendomois (1908) 192 pp.
See also *Ann. Mycol.*, vii. (1909) p. 490.
- MORIGNONI, G. B.—**Micromiceti de Schio.** (Micromycetes of Schio.)
[First contribution to the mycological flora of the Province of Vicenza.]
Schio: (1909) 32 pp. (2 figs.). See also *Ann. Mycol.*, vii. (1909) p. 80.
- MASSALONGO, C.—**Osservazioni fitologiche.** (Phytological observations.)
[The part devoted to fungi takes note of a number of new forms of microfungi.]
Madonna Verona, 11A, i. (1908) 12 pp. (12 figs.).
See also *Ann. Mycol.*, vii. (1909) pp. 490-1.
- ” ” **Nuove osservazioni fitologiche.** (Further observations.)
[Diagnoses of two new species, *Cercospora Rautensis* and *Ramularia Gardeniæ*.]
Op. cit., (1909) 23 pp. (18 figs.).
See also *Ann. Mycol.*, vii. (1909) p. 491.
- MAZÉ, P.—**Note sur la production d'acide citrique par les Citromyces.** (Note on the production of citric acid by Citromyces.)
[The author concludes that the production of citric acid is a result of incomplete respiratory oxidation.]
Ann. Inst. Pasteur, xxiii. (1909) pp. 830-3.
- MORTENSEN, L.—**Versuche über die Giftwirkung von Kobalt-Salzen auf Aspergillus niger bei Kultur auf festen und flüssigen Medien.** (Experiments on the poisonous action of cobalt salts on *Aspergillus niger* in solid and fluid media.)
Centralbl. Bakt., xxiv. (1909) pp. 521-38 (4 figs.).
- PETRI, L.—**Flora Italica Cryptogama. I. Fungi.**
[Includes the Gasterales: Scotiaceæ, Lycoperdaceæ, and Sclerodermatacææ. Stress is laid on the capillitium as a diagnostic character.]
Rocca: S. Casciano (1909) 140 pp.. 83 figs.
- RAYBAUD, LAURENT—**De l'influence des rayons ultra-violetes sur le développement des moisissures.** (On the influence of the ultra-violet rays on the development of moulds.)
[They were found hurtful, as in the case of bacteria.]
Comptes Rendus, cxlix. (1909) pp. 634-6.

- REHM, H.—**Ascomycetes exs. Fasc. 44.**
 [Includes Nos. 1826-50; several species are new, others are re-described and notes added.]
Ann. Mycol., vii. (1909) pp. 399-405.
- „ **Die Clypeosphaariaceæ der deutschen Flora.**
 [A review of all the species, with special reference to South Germany.]
Tom. cit., pp. 406-12.
- „ **Die Microthyriaceæ der deutschen Flora.**
 [Also with reference to South Germany; notes are added to some of the species.]
Tom. cit., pp. 413-17.
- SACCARDO, P. A.—**Notæ Mycologicaæ.**
 [Notes on descriptions of thirty-one species, several of them new to science.]
Tom. cit., pp. 432-7.
- SYDOW—**Mycotheca Germanica. Fasc. xvi-xvii.**
 [Nos. 751-850 are listed, a number of them accompanied with notes, and new species described.]
Tom. cit., pp. 437-40.
- WILSON, G. W., & FRED JAY SEAVER **Ascomycetes and Lower Fungi. Fasc. iii.**
 [Records of various microscopic fungi, Nos. 51-75. Habitat and locality are given.]
Mycologia, i. (1909) pp. 268-73.

Lichens.

(BY A. LORRAIN SMITH.)

New Lichens.*—A. Zahlbruckner describes a number of new species, with various added notes. *Arthopyrenia peranomala* he classifies among lichens without being able to detect gonidia, from the fact that the perithecium is open below, a character not to be found in allied fungi. A new *Usnea* from India (*U. subchalybæa*) forms dense erect clumps about 4 cm. high. It approaches *U. sulphurea* in habit. Finally, two new species of *Buellia*, on basalt rocks from Arizona, differing from each other in the reaction with potash and other details.

Lichens from Greece.—The list of 178 lichens here published represents a collection made by René Maire † during a botanical journey in 1904, and by him, along with M. Petitnengin, in 1906. They were examined and determined by Harmand and Bouly de Lesdain. The flora of the calcareous hills resembles that of the calcareous Alps; that of the siliceous rocks has not been sufficiently explored to permit of wide generalisation. A striking feature of the flora is the predominance of Lecanorine forms over Lecideine; there are only few Arctic-Alpine species on the high summits, but on these heights were found lichens that inhabit the hills and lower mountains of Central Europe. Corticolous species are much like those of Central Europe. A few new species and sub-species occur in the list.

Arctic Lichens.‡—Otto V. Darbishire includes in this list the lichens recorded from Arctic America, Greenland, Spitzbergen, and

* *Ann. Mycol.*, vii. (1909) pp. 472-8.

† *Bull. Soc. Sci. Nancy*, fasc. 6 (1909) 36 pp.

‡ Norwegian Arctic Exped. 'Fram,' 1898-1902 (1909) Report 2, 68 pp. (2 pls.).

Iceland. It has been compiled from lists published by various authors and from material brought back by the Norwegian Polar Expedition. Darbshire found eight new species in the material brought home by the 'Fram,' the most striking of these being *Placodium splendens*, somewhat resembling *P. elegans*, but occasionally forming upright podetia. Fruticulous lichens grew abundantly, though there are few species; species of *Gyrophora* and *Parmelia lanata* were among the commonest. A series of ecological notes are given of the different lichens, and there is a bibliography of publications on Arctic lichens. Habitat and locality are given with each species.

Siberian Lichens.*—E. A. Wainio describes the lichens collected by E. Almquist in Northern Siberia, and gives an account of the conditions in which they were found. The country round Pitlekai, where they were collected, is uniform and very bare. On the sand dunes of the sea-shore *Cetraria hiascens* was occasionally found; further inland occurred patches of moss and a considerable variety of lichens: *Ochrolechia tartarea*, *Lecanoræ*, *Lecidææ*, *Pertusariæ*, *Parmeliæ*, *Cladoniæ*, etc. Stones the size of one's fist were scattered around, and on these grew another series of crustaceous lichens, *Lecidææ*, etc. On some smaller stones near by, *Umbilicaria proboscidea* grew abundantly. Detailed lists of these lichens are given by the author according to habitat, and then a full account of all the species, with diagnosis of new forms.

Chemistry of Lichens.†—An important paper has been issued by Zopf on the chemical products of *Peltigera*, *Solorina*, and *Nephroma*. He finds several new bodies: peltigerin in all the species of *Peltigera* examined, with the exception of *P. canina*, *P. rufescens*, *P. spuria*, and *P. prætexta*. Another new substance is polydactylin. Zopf deduces from these researches that the genus *Peltidea* should not be separated from *Peltigera*, as the chemical products are so akin.

GRILLI, C.—**Sul Callophisma luteo-album var. lacteum.**

[The writer describes the variety as a species of *Gyalolechia*.]

Bull. Soc. Bot. Ital., 1909, pp. 152-4.

HASSE, H. E.—**Additions to the Lichen-flora of Southern California. No. 2.**

[A description of nine species of lichens, only two of which are peculiar to America; the others are also found in Europe.]

Bryologist, xii. (1909) pp. 101-4.

MERRIL, G. K.—**Lichen Notes. No. 14.**

[Description of three new species of *Calicium*.]

Tom. cit., xii. (1909) pp. 107-8.

ZAHLBRUCKNER, A.—**Vorarbeiten zu einer Flechtenflora Dalmatiens.** (Preliminary work for a lichen flora of Dalmatia.)

[Several species of Verrucariaceæ and Dermatocarpaceæ are dealt with, some of them new.]

Oesterr. Bot. Zeit., lix. (1909) pp. 315-21.

* *Ark. Bot.*, viii. No. 4 (1909) 175 pp.

† *Lieb's Ann. Chemie*, cclxiv. (1909) pp. 273-313. See also *Bot. Centralbl.* cxi. (1909) pp. 231-2.

Schizophyta.

Schizomycetes.

Bacillus arenicolæ.*—H. B. Fantham and Annie Porter have found in the gut of *Arenicola caudata* a bacillus which damages the gut and may hasten the death of the Annelid. The bacillus is from 7–17 μ long by 0.7–1.3 μ broad, averaging 11 μ by 1 μ . Internally it shows many darkly staining granules, often arranged in the form of transverse bars. These granules are probably composed of chromatin. The authors think that a nucleus exists in the form of a chromidial system. Some of the colorable granules are refringent and probably consist of meta-chromatin. The cytoplasm stains with difficulty, while the periplast stains deeply. Division is by transverse septation. *B. arenicolæ* forms one terminal spore.

Granules of Plague Bacilli.†—F. Vay states that in plague bacilli cultivated artificially granules are demonstrable which are extremely like in shape, position and general appearance bodies which have been described as nuclei. They are not fat inclusions, and are not demonstrable in bacteria found in the animal body.

Media which Attenuate or Exalt the Virulence of Tubercle Bacilli.‡—Baudran, by cultivating *B. tuberculosis* on a medium composed of glycerophosphate of iron 0.2, metaphosphate of soda 5, citrate of soda 2, glycerin 60, albumoses Byla 10, distilled water 1000, obtained a growth in which the bacilli were much attenuated, of dumb-bell shape, and staining feebly only at the ends. The pathogenic effect on animals was almost nil. When the iron was replaced by a similar quantity of phosphate of manganese the morphological and tinctorial characters were similar, but animals injected with the toxin or the bacilli rapidly succumbed.

Spirochæta eurygyrata and S. stenogyrata.§—H. Werner discovered in human faeces two Spirochætes, one with broad, the other with narrow turns of the spirals. *S. eurygyrata* varies 4.6–7.3 μ ; the turns are broad and thick. The length of *S. stenogyrata* is from 3.5–6.1 μ ; the turns are much finer and closer than in *S. eurygyrata*. Apparently they are not identical with Spirochætes found in the mouth, and are probably very common habitants of the human alimentary canal.

Microbes on Fruit.||—A. Sartory and A. Filassier call attention to the possibility of the transmission of disease by raw fruit, e.g. grapes, strawberries, and gooseberries. The principal species detected were *Staphylococcus aureus*, *Streptococcus*, *B. termo*, *B. subtilis*, *M. caudicans*, *Penicillium glaucum*, *Rhizopus nigricans*.

Actinomyces of the Cornea.¶—B. Namysłowski describes two Actinomycetes obtained from the human cornea, the species being

* Centralbl. Bakt., 1te. Abt. Orig., lii. (1909) pp. 329–34 (1 pl.).

† Tom. cit., pp. 305–18 (1 pl.).

‡ Comptos Rendus, cxlix. (1909) pp. 874–5.

§ Centralbl. Bakt., 1te. Abt. Orig., lii. (1909) pp. 241–3 (1 pl.).

|| C. R. Soc. Biol. Paris, lxxvii. (1909) pp. 445–7.

¶ Bull. Internat. Acad. Sci. Cracovie, 1909, pp. 418–27 (1 pl.).

A. radiatus and *A. cerebriiformis*. The specific names are derived from the cultural appearances, and an examination of the photographs shows that these befit them well. Both species grow well on most media: *A. radiatus* is white to grey, while *A. cerebriiformis* is yellow to yellowish-orange; both liquefy gelatin; both form filaments and shorter elements supposed to be spores.

Hillhousia mirabilis.*—*Hillhousia mirabilis*, says G. S. West, is a sulphur bacterium of giant proportions, and is much the largest solitary bacterium which has so far been discovered. Its average length is about 60 μ and breadth about 26 μ . The organism is a peritrichous bacterium, with a large number of short cilia. It occurs among decaying organic matter in the mud of shallow fresh-water pools. Each individual contains a protoplasmic network, in the wide meshes of which large globules of sulphur (probably not pure, but in loose combination with proteid material) are located. The network includes numerous small granules, a considerable proportion of which consist of some nucleoproteid. None of them are chromatin granules. The cell-wall is firm, and has great power of resistance to reagents. It is not homogeneous, and 5 p.c. carbolic acid demonstrates its lamellar character. The multiplication of this organism is relatively slow, one division occupying upwards of 24 hours.

Fixation of the Complement in Glanders.†—Miessner and Trapp make an important communication on the fixation of complement in glanders, and its relation to the syphilis reaction. They describe the complement fixation methods, the antigen, the serum, the amboceptor, the complement, the blood corpuscles, and give details in respect of mallein. Some of the important results were: that complement fixation was positive in 95.7 p.c. of glandered, and in 1.27 p.c. normal horses. A suitable antigen was found in an aqueous extract of glanders bacilli made from an agar culture with 250–1000 of phenol saline. The antigens were very sensitive to daylight, but bore boiling and minus temperatures of -10° to -15° well. With aqueous extracts of organs of glandered and normal horses and guinea-pigs, there was no complement fixation with the serum of glandered horses: similar results were obtained when alcoholic extracts were used, and also with oleate of sodium, oleic acid, and lecithin. For further details the original should be consulted.

Coccobacillus conjunctivæ.‡—V. Ruata describes a Gram-negative organism which presents itself both as a diplococcus and also as a bacillus. By its morphological, cultural, and pathogenic characters, it is easily distinguished from other Gram-negative germs. Owing to its varying morphology it is termed *Coccobacillus conjunctivæ*. Its pathogenicity is slight, though when injected into a rabbit's eye it causes a panophthalmitis, but seems to have no action on human connective tissues.

* Proc. Roy. Soc., Ser. B, lxxxi. (1909) pp. 398–405 (1 pl.).

† Centralbl. Bakt., 1^{te} Abt. Orig., lii. (1909) pp. 115–46.

‡ Tom. cit., pp. 630–44 (1 pl.).

Presence of Bacteria in Echinococci and Cysticerci.*—R. Mehlhose, in an important communication, draws attention to the bacterial contents of the bladder-forms of tapeworms. The author presents his case in tabular form, and cites sixty examples, and afterwards describes the bacteria.

Flagella of *Spirillum volutans*.†—F. Fuhrman found that these varied in number from fifteen to twenty-five. They rise for the most part in a single tuft at a point near one pole, but smaller secondary tufts occur. The average length is 12–18 μ , but in older cultures flagella of much greater length, as much as 72 μ , are seen. Their thickness is estimated at 0.03–0.05 μ . Flagella are described as consisting of a proximal portion, starting from a point in the cell-plasma situated near the pole, and passing to the cell-membrane, and of a distal free portion, beginning at the outer aspect of the cell-membrane. The free portion is normally structureless. The proximal portion is a fine thread, resembling somewhat a chromatin-fibre. The point of origin is analogous to the blepharoplast of Flagellates.

Causes of certain Plant Diseases.‡—A. Osterwalder describes a new species of bacterium, *Pseudomonas levistici*, parasitic upon *Levisticum officinale*, which makes stains upon the leaves and dark brown streaks upon the stem. It is a small organism, rounded at one end and provided with a terminal flagellum. It grows well on nutrient agar and on gelatin, which it liquefies. It forms indol, and is Gram-negative. Spore-formation has not been observed.

Phytophthora omnivora is parasitic upon *Culceolaria rugosa*. The disease spreads from the stem, causing the plant to wither and die.

Sclerotinia libertiana causes a fatal disease in *Omphalodes verna*.

Chelone glabra and *C. barbata* are attacked by *Tylencephalus devastatrix*, a Nematode, which, in the former species, causes remarkable distortions of the stem.

Comparative Studies of the Myxobacteriaceæ and the Bacteriaceæ.§—C. Vahle gives an account of his work upon some of the Myxobacteria. The types investigated were the *Myxococcus ruber*, *Myxococcus virescens*, *Polyangium fuscum*, and *Chondromyces crocatus*. The author gives an exhaustive account of the development and morphology of the spores and the vegetative forms. These organisms differ in some important respects from the bacteria proper. In Myxobacteria fission takes place by the drawing apart of the daughter-cells rather than by the formation of a septum, as in bacteria. The true cell-membrane of bacteria is represented in Myxobacteria by an adhesive pellicle of a different nature. Myxobacteria possess no flagella, and their mechanism for movement has not been clearly demonstrated. The development, morphology, and germination of the spores show further points of difference. On the other hand, a comparison of these types of Myxobacteria with certain of the Myxomyetes shows many striking points of similarity, more particularly in respect of methods of repro-

* Centralbl. Bakt., 1^{te} Abt. Orig., lii. (1909) pp. 43–74 (1 pl.).

† Op. cit., 2^{te} Abt., xxv. (1909) pp. 135–59.

‡ Tom. cit., pp. 260–70.

§ Tom. cit., pp. 178–260.

duction and spore-formation. The author is of opinion, therefore, that Myxobacteria ought to be included among the Myxomycetes as a special family akin to the Guttulinaceæ and the Dictyosteliaceæ.

Vahle also gives an account of the cultural, morphological, and physiological characters of the *B. oxalaticus* of Kuntze, and compares it with the *B. ruminatus* of Gottheil. He describes the germination of the spores upon dextrose-agar and upon sugar-free agar media. The optimum temperature for the germination of spores is 37° C., the maximum 47° C. Spore formation did not take place at a temperature above 40°. These two organisms resemble each other greatly, the most marked difference being found in the resistance of the spores to heat, and in the effect of temperature upon germination. The *B. oxalaticus* has less power of resistance than *B. ruminatus*.

Lastly, this author compares *Spirillum rubrum* and *S. volutans*. The former possesses four flagella at each end, whereas the latter has one large tuft. Both organisms are difficult to stain. Their cultural characters are almost identical. Their physiological characters are similar. They both have little power of resistance to high temperatures. The pigment formation of the former organism is the only salient point of distinction.

Relation of the Ratin-bacillus to the Bacilli of the Gaertner Group.*—Nylander found that the cultural characters of the Ratin-bacillus and of a large number of bacilli belonging to the Gaertner group were similar. The sugar-fermentation reactions were identical. Agglutination reactions differentiate sharply between Ratin-bacillus and the *B. paratyphosus* β , but fail to differentiate between Ratin-bacillus and the original bacillus of Gaertner. The addition of 0.8 p.c. of caffeine to nutrient agar causes modifications in the size and form of the Ratin-bacillus as of the Gaertner bacillus. A thermostable toxin produced by the Ratin-bacillus resembles greatly the toxins of the Gaertner group in its effect upon animals. The author concludes that this organism should be included in the Gaertner group.

Nylander also reports upon "Ratin II.," a proprietary substance designed for the destruction of rats. It claims to be a bacterial culture, but the author shows that it is in reality not a bacterial substance at all, but is largely composed of an extract of squills.

Observations on certain Lactic Acid Bacteria of the so-called Bulgaricus type.†—B. White and O. T. Avery obtained cultures from a large number of sources. These included commercial preparations, cultures from various laboratories, and strains isolated from the preparations of native Armenians. They found that, in cultural and morphological characters, these organisms had much in common with one another and with the group of *Bacteria caucasica*. They are non-motile, and do not form spores. Viable bacilli are Gram-positive; involution forms are Gram-negative. Freshly isolated organisms grow upon milk or upon media containing whey or malt. The optimum temperature is 40–50° C.

* Centralbl. Bakt., 1te Abt. lii. (1909) pp. 455–68.

† Op. cit., 2te Abt., xv. (1909) pp. 161–78.

Gelatin is not liquefied. In most cases, milk was found to be the best culture-medium.

The authors differentiate two types, A and B. In type A, 2·7–3·7 p.c. of lactic acid is produced in milk, this lactic acid being of the inactive modification. The protoplasm is stained homogeneously by Löffler's methylen-blue or Neisser's stain. Bacilli of type B so stained show deeply staining granules, and in milk 1·2–1·6 p.c. of lactic acid is formed.

Bacillus septicæmiæ anserum exsudativæ.*—P. Frosch and K. Bierbaum isolated this organism from the heart-blood and peritoneal fluid of two geese that had died of goose-plague. It possesses many points of resemblance to the *B. influenzae* Pfeiffer. It is a small bacillus 0·5–1·5 μ long, 0·5 μ in breadth. It takes up the ordinary stains, but is Gram-negative. It stains best with carbol-fuchsin. It is non-motile, and does not form spores. When first isolated it grows only upon media containing blood, but after cultivation for about twenty generations it will grow upon alkaline agar and some other media. The optimum temperature is 37° C. Cultures possess low vitality and are prone to die out. It is assigned to the group of pseudo-influenza bacilli.

MERESKOWSKY, S. S.—**Ueber die Eigentümlichkeit des Bac. typhi spermophilorum in media welche Trauben- oder Milchzucker enthalten.**

[Peculiarities of *B. typhi spermophilorum* in media which contain grape- or milk-sugar.] *Centralbl. Bakt.*, 1te Abt. Orig., lii. (1909) pp. 427–9.

KENDALL, A. J.—**Bacillus infantilis (sp. n.) and its Relation to Infantilism.**

[Describes asporogenous, aerobic, Gram-positive, motile bacillus found in cases of infantile diarrhoea.]

Journ. Biol. Chem., v. (1909) pp. 419–37.

GLECKEL, D.—**Vergleichende untersuchungen der biochemischen Eigenschaften des Bacillus osteomyelitis Henke mit denen des Staphylococcus aureus, S. citreus, und B. coli communis.**

[Comparative researches on the biochemical characters of *B. osteomyelitis* Henke and those of *Staphylococcus aureus*, *S. citreus*, and *B. coli*.

Centralbl. Bakt., 1te Abt. Orig., lii. (1909) pp. 318–29.

WESTERGAARD, E.—**On the Development of Mixed Cultures of Bacteria and Lower Fungi in Liquid and Solid Media. (Preliminary notice.)**

Proc. Roy. Soc. Edin., xxix. (1909) p. 748.

SHATTOCK, S. G., & L. S. DUDGEON—**Note on the Relationship between Avian and Human Tuberculosis.**

[Experiments showing the immunity of white rats to avian tuberculosis.]

Lancet (1909) ii. pp. 1739–42.

* *Centralbl. Bakt.*, 1te Abt., lii. (1909) pp. 432–40.

MICROSCOPY.

A. Instruments, Accessories, etc.*

(1) Stands.

Zeiss' Microscope for Investigating Ultra-microscopical Particles.†
This instrument is clamped to the foot-plate or board on which the rest

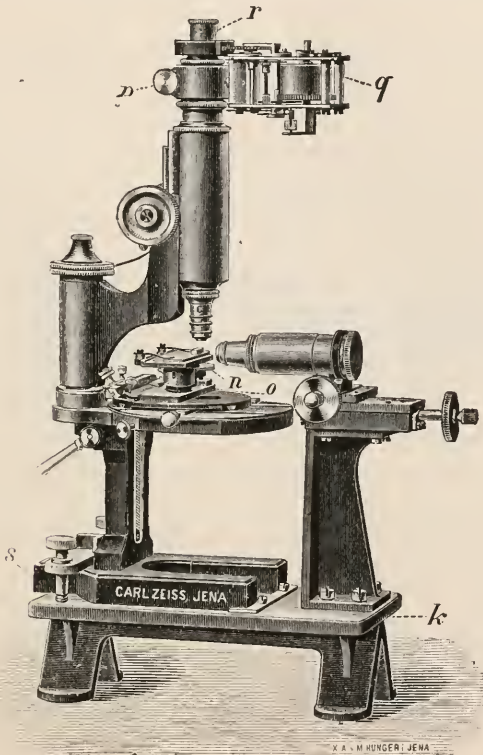

FIG. 5.

of the apparatus for demonstrating ultra-microscopic particles are placed. The microscope has a large mechanical stage and a special object-stage *o*, which can be elevated. It is provided at the back with a heading for

* This sub-division contains (1) Stands; (2) Eye-pieces and Objectives; (3) Illuminating and other Apparatus; (4) Photomicrography; (5) Microscopical Optics and Manipulation; (6) Miscellaneous.

† Zeiss' Catalogue, Ultra-microscopy and Dark-ground Illumination, 3rd ed., 1907, pp. 15-19, fig. 11.

sliding into the groove of the large mechanical stage after the springs have been withdrawn. The object-stage can be elevated by means of the screw n_1 ; it terminates at the top in a plate, on which the specimen to be examined is placed. The Microscope, as shown in the illustration (fig. 5), is fitted with dissecting-stage and rotating-analyser on the sole-plate with cross slides.

Some of the accessory apparatus used with this Microscope have been described already.*

ELEIZEGUI, A.—*Un nuevo modelo de microscopio para la enseñanza* (1 fig.). *Bol. de la R. Soc. española de Hist. Nat.*, viii. (1908) pp. 442-4.

(3) Illuminating and other Apparatus.

Beck-Gordon Speculum Lamp.†—This lamp (fig. 6) is made for use with the incandescent electric light or the incandescent pendent gas mantle. The lamp depends for its action on a polished glass cylinder

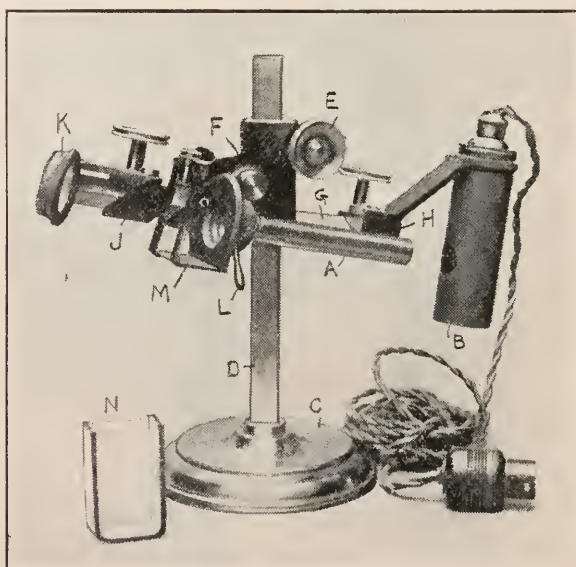

FIG. 6.

A several inches long, into one end of which light from the lamp B enters. The light so entering is totally reflected along the sides of the cylinder in such a manner that when it leaves the other end it emerges in all directions not exceeding a moderate angle, so that this end becomes a radiant surface, and behaves as if it were a practically homogeneous disk source of light. In order to secure the best "critical" illumination with powers this surface is focused on to the object instead of the actual

* See this Journal, 1907, p. 615, and 1906, p. 369.

† Special Catalogue, 1909, R. and J. Beck, Ltd.

illuminant by the substage condenser. The instrument consists of a heavy stand C with an upright rod D, up and down which the lamp can be moved with a rack-and-pinion E. The glass rod A is fixed to a block F, which can be pivoted at an angle so that the light may be directed either up or down, rendering the lamp useful for every kind of illumination for either high or low powers. The block F carries a bar G which carries the fitting H of the electric light B, and also the fitting J of the bull's-eye K. The bar G can be moved and clamped in the block F, thus giving a rough adjustment for moving the lamp B, or the bull's-eye K, nearer to or further from the glass rod A. The lamp B and the bull's-eye K can also be both moved by rack-and-pinion motions along the bar G. The lamp B when placed close to the end of the glass rod A gives a very intense illumination, as a large proportion of light enters the glass rod; but as it is moved away by the rack-and-pinion the intensity of the light is reduced rapidly, varying according to the square of the distance of the lamp B from the end of the glass rod A. The condenser K can be swung out of the way when not required, and can be focused by means of the rack-and-pinion so as to give parallel light or to focus the light to a small area for the illumination of opaque objects. In front of the illuminated disk end of the glass rod an iris-diaphragm moved by a lever L is placed, which enables the illuminated disk to be reduced in size, and which forms when closed down the best object by which to focus the disk upon the microscopic object with the substage condenser for producing critical illumination. In front of the iris-diaphragm is a stage M which carries a trough N for acetate of copper, or other monochromatic solution, and by means of clips, glass colour filters, patch stops, or other appliances, can be attached to this stage.

New Form of Polarimeter for the Measurement of the Refractive Index of Opaque Bodies.*—W. T. Barrett's instrument for the above purpose depends upon Brewster's well-known principle that the index of refraction of any substance is the tangent of the angle of maximum polarisation for that substance, and that, hence, when a ray of light incident on a transparent body is polarised by reflection, the refracted ray forms a right angle with the reflected ray. By means of Brewster's Law the indices of refraction of various opaque non-metallic reflecting surfaces have been obtained. As every different colour has a different index of refraction, the law shows that the polarising angle correspondingly varies with the different rays of the spectrum, being, for a given substance, smallest in the red and largest in the violet. In bodies of low dispersive power the angle of maximum polarisation is nearly the same for all colours, and white light can be used as the source. In other cases monochromatic light must be employed—either a sodium flame or suitably coloured glass in front of the source described below. The amount of light reflected from some opaque bodies is small, and hence the determination of the polarising angle is difficult, unless we can always keep the analyser placed in the reflected beam at the same angle as the ray incident on the opaque surface under examination. To secure this, the

* Sci. Proc. Roy. Dublin Soc., xii. (1909) pp. 93-901 (2 figs.).

author has devised the following instrument (fig. 7), whereby with a rack-work and simple link-motion, the collimator, which renders the

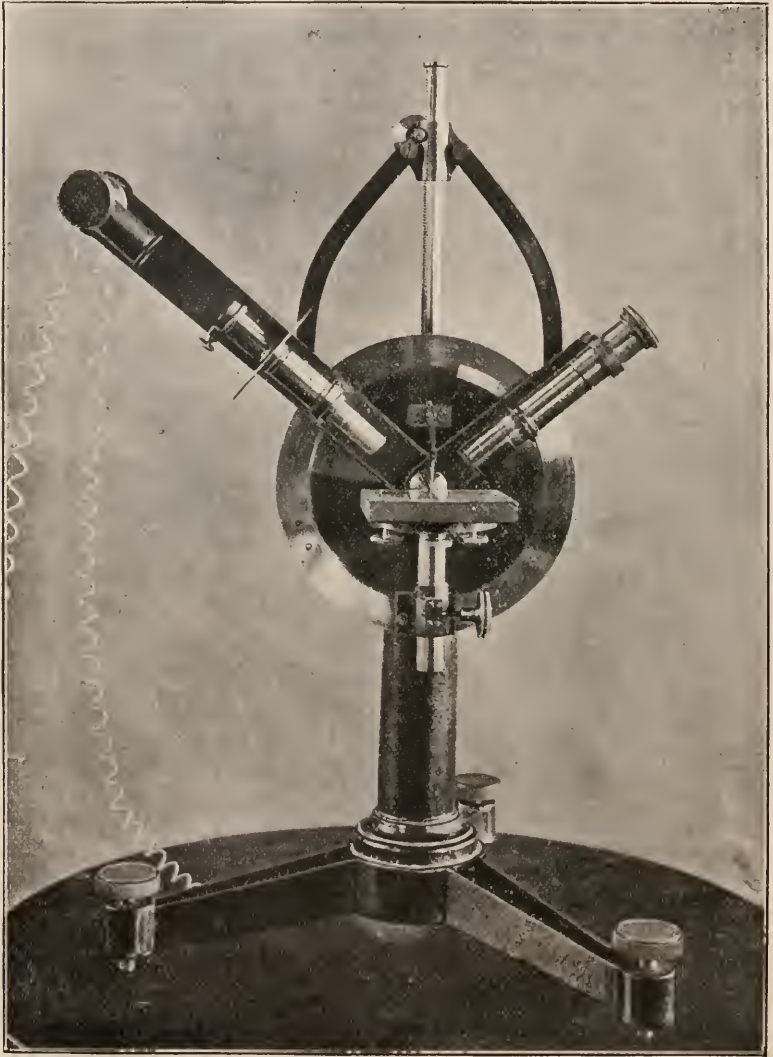

FIG. 7.

incident rays parallel, and the telescope, in which is placed the analysing Nicol's prism, are simultaneously moved through equal angles. The opaque body is placed on a movable table with levelling screws, which

are adjusted until the reflecting surface is level, and at the centre of the graduated circle round which travel the telescope and collimator. A small but brilliant source of light is employed, such as a Nernst or a 10-volt electric glow-lamp; a small lens throws a brilliant image of the light on to the adjustable slit of the collimator. This latter contains a lens in a draw-tube, so that a parallel beam falls on the opaque reflecting surface: and a sharp image of the slit is obtained by the lens in the telescope, which also contains a small Nicol's prism. Upon turning the rack-work handle the source of light and collimator move together, and through the same angle as the telescope. The observer now turns the polarising plane of the Nicol at right angles to the plane of the reflected

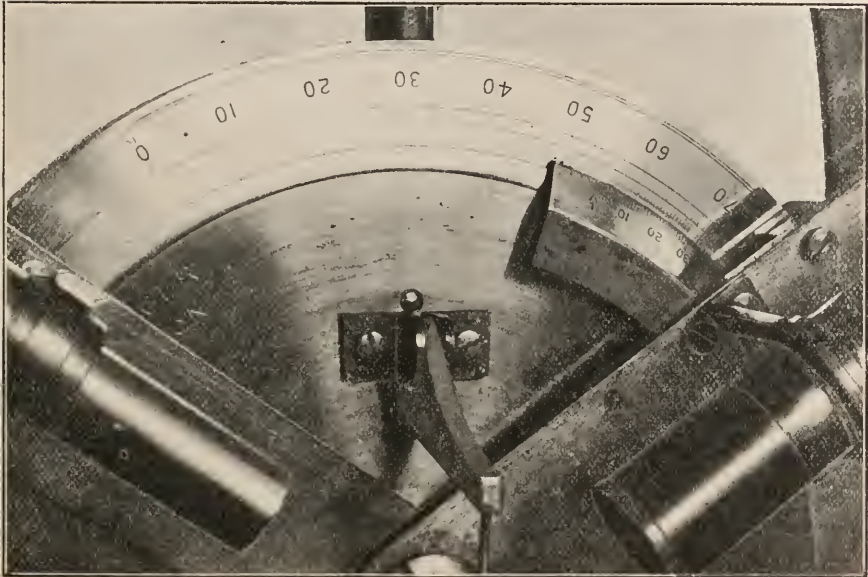

FIG. 8.

polarised ray, and watches the gradual extinction of the light as the polarising angle is approached. At the angle of maximum polarisation the light is extinguished (reappearing as the angle is passed), the clamping-screw is then turned, and, by means of the vernier, the angle is read off in degrees and minutes. As the polarising angle of nearly all substances lies between 48° and 68° , the circle need not be finely graduated for more than 20° . An enlarged view of scale and vernier is shown in fig. 8. It is, of course, essential that the light incident on the opaque surface be strictly parallel; and careful adjustment of the collimator must be made beforehand for this purpose. Provision is also made in the instrument for two other adjustments, namely (1) the coincidence of the axis of collimation and the zero of

the scale, and (2) of the reflecting surface to be tested with the centre of the graduated circle. This latter is accomplished by a small projecting arm with a platinum point.

Liquids are placed in a little glass capsule on the levelling table, which is adjusted until the platinum point, indicating the centre of the circle, just touches the liquid surface. Bodies having an irregular, granular, or crystalline surface, if fusible, are melted. This is accomplished by placing them in a small capsule of metal or porcelain, which is heated by a current of steam or an electric current traversing a platinum wire coiled round the capsule. In practice a difficulty occurs in determining the precise angle of maximum polarisation; for the extinction of the reflected ray seems to spread over a narrow region rather than to occur at a definite point. This error, however, can be lessened by careful attention to the parallelism of the incident rays and homogeneity and intensity of the light. The author employed a small direct vision-prism spectroscope in the collimator and obtained a sharp spectrum, using, of course, a very brilliant source of white light. In this way he hoped to obtain the angle of extinction for a definite colour and thus see a dark band pass across the spectrum, as the polarising angle for such colour was reached. In the case of bodies of very high dispersion, such as nitroso-dimethyl-aniline, the dark band is sharp and well-defined. But in the case of bodies of low-dispersive power, a faint broad shadow is observed to move across the spectrum, the best position to read being when the shadow is in the green or greenish-blue; results can then be obtained within 20' to 30', even with this preliminary apparatus.

Pringsheim's Yellow Filters.*—E. Pringsheim, jun., constructs his filters in the following manner: White glass plates (e.g. old photographic plates) are thoroughly cleaned by a solution of potassium bichromate in concentrated sulphuric acid, rinsed in running water, and, the future disk-side downwards, dried by being placed obliquely on blotting-paper. This cleaning facilitates the future adhesion of the gelatin layer. Every speck of dust is to be avoided. A deep reddish-brown solution in distilled water to which 20 p.c. gelatin has been added is filtered in a steam chamber, and a little glycerine at the rate of a single drop per 100 c.cm., is added to prevent undue brittleness to the layer. Some boric acid is also added to prevent growth of moulds. Boric acid is too weak to influence the colour, but must be added sparingly as it is apt to crystallise out in drying. The cleaned glass plates are set out on a larger glass plate accurately levelled. The gelatin solution is poured on to the middle of the plates, and must be hot, so that the application may be uniform in thickness. Any want of success may usually be made good by heating up the unsuccessful part on an asbestos layer. When the gelatin has solidified the plates are kept obliquely in a dry place as dustless as possible. With rare exceptions the gelatin layer will be found so uniformly applied, that, when held between the eye and a newspaper, the printing seems scarcely affected. Two such plates may be turned inwards and cemented by Canada balsam.

The author not only uses his filters for the windows of a box for studying the heliotropism of plants, but applies them to the study of

* Ber. Deutsch. Bot. Gesell., xxvii. (1908) pp. 556-65 (4 figs.).

microscopic organisms (e.g. algæ-swarms, *Euglenæ*, *Volvox* colonies, etc.) sensitive to light. The apparatus is shown in fig. 9, where the filter

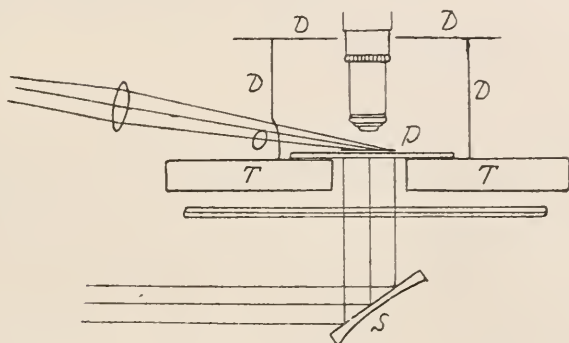
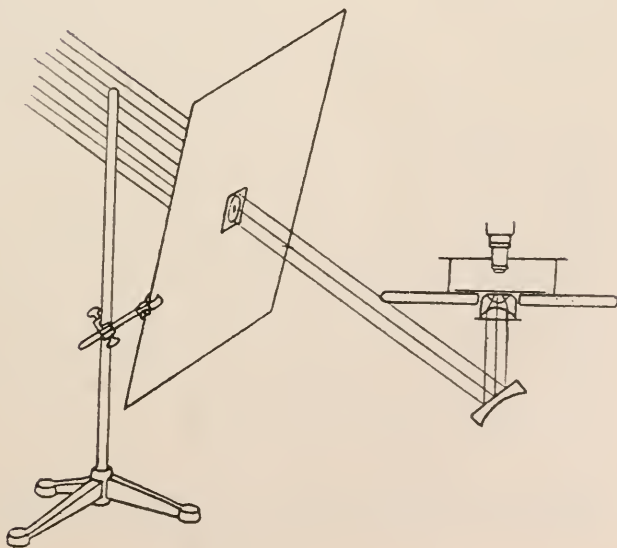
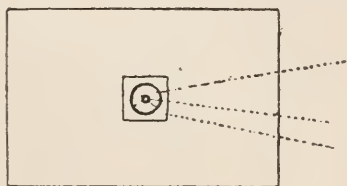

FIG. 9.



FIGS. 10, 11.

will be observed underneath the stage T. the light passing through it after reflection at the mirror S. On the stage itself a black cardboard

Feb. 16th, 1910

H

tube, D, with a lid perforated for the objective, completely surrounds and incloses the object P. Through an aperture, O, ordinary light concentrated by a lens can be concentrated on the object. The influence of the yellow light upon such organisms as are sensitive to bright ordinary light can then be studied.

It is well known that Engelmann has shown, by arranging a spot of light in a dark ground, that many organisms lose their activity when no longer in the light spot. The author varies this experiment by introducing a light flicker in a yellow field, and his apparatus is shown in figs. 10 and 11. A simple small gelatin disk containing a small colourless circle of 5 mm. diameter is projected into the plane of the preparation. Racking of the illuminating apparatus will secure sharp definition of the circumference of the circle in the image of the organisms. A cover-glass acts as the glass disk, and the colourless circle is obtained by application of a drop of hydrochloric acid and subsequent treatment by a moist camel's-hair pencil. Any slight reddening due to the acid is made good by ammonia. The cover-glass is fastened with strips of paper pasted on to a large sheet of cardboard, whose plane is arranged

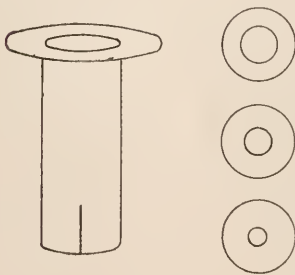

FIG. 12.

normally to the incident light-rays. A very slight displacement of the mirror shifts the bright spot, so that organisms which had previously clustered in the white light come now under the influence of the yellow light.

Dark-ground Illumination.*—S. C. A. describes how he successfully obtained good dark-ground illumination with a Zeiss DD₁ N.A. .85 one-sixth Reichert 7A N.A. .87 one-seventh, using Baker's achromatic condenser N.A. 1.0. "All that is necessary is to insert a metal tube in back of objective, one end of which comes in close contact with the back lens of the objective. This end is split to enable a small metal disk to be sprung into it; the other end has a collar, which sits on the top of objective. Two or three metal disks are necessary, each having the centre punched out, giving varying apertures, a large or a small aperture being used according to the amount of light to be stopped out. I generally leave the tube in my $\frac{1}{4}$ in., in which case all that is necessary to obtain dark ground is to place expanding spot in condenser carrier. This extra amount of work to be readily obtained from an objective will be appreciated. Diaphragms, or a Davis shutter, are of no use for dark ground illumination with high powers, as they work too far away from back lens of objective." (fig. 12).

Use of the Polariscope in Testing High-tension Insulators.†
C. F. Harding shows that with the aid of the polariscope it is not only possible to determine some of the causes for the unsatisfactory service

* English Mechanic, xc. (1909) p. 311 (1 fig.).

† Proc. Indiana Acad. Sci., 1908 (issued 1909) pp. 147-9.

given by certain glass insulators, but it is also possible to make preliminary acceptance tests upon new insulators, and to eliminate all of those which show signs of improper annealing.

EVATT, EV. J.—**The Cameragraph: a Drawing Apparatus.**

Journ. Anat. and Physiol., iii. (1908) pp. 335-6.

(4) Photomicrography.

Cheap non-vibrating Suspension for Microphotography.*—R. G. Perkins takes a 2-in. plank 14 in. wide and fixes on it in optical alignment the various parts of the apparatus. It is of course necessary to have some arrangement so that the light and the collecting lens may be adjusted, though to save expense, a median fixed position may be secured with good results for all powers. The bellows should slide in the focal plane, so as to admit of looking in the eyepiece of the Microscope for the area to be photographed. Two cleats of hard wood were screwed to the bottom of the plank near the ends, and through these four screw-eyes were bolted. Four pulleys were fastened on the ceiling with window cord passing from the cleats on the wall through the pulleys and down to the screw-eyes in the plank. At any point between the ceiling pulleys and the screw-eyes were interposed extension springs of such a tension that the rings would be separated about an eighth of an inch when the whole weight of the apparatus came upon them. The plank and its fixtures were then raised by its cords to a convenient height, the light connected with its source, and the machine was complete. The advantages which have been found in this arrangement are, in the first place, the absolute removal of building vibration, exposures of one second or one hour being equally clear, even with the whole affair swinging to and fro and up and down. In the second place, there are no legs underneath to be kicked or to get in the way, and the plank can be pulled up to the ceiling if desired to give more space in the dark room. In the third place, the plank and the suspension cost only three dollars, besides the time necessary for installation.

Resolving Power of Photographic Plates.†—C. E. Kenneth Mees points out that, while great attention has been paid to the resolving power of lenses, very little has been done for the resolving power of the photographic plates which are largely used in recording instruments. He considers that the resolving power may be defined as the distance which must separate two lines of light falling upon the plate in order that the developed image may be recognised to be that of two separate lines. It is clearly of no use to obtain a higher resolving power in an instrument than the plate used in that instrument will possess. The only attempt to state this resolving power appears to be that of Wadsworth,‡ who lays down that two lines can be separated if between the particles in the maxima of the lines there are one silver particle and two spaces, that is to say, the linear distance between the two maxima or centres of the line is equal to four times the diameter of a particle.

* Johns Hopkins Hosp. Bull., xx. (1909) p. 325.

† Proc. Roy. Soc., lxxxiii. (1909) pp. 810-18 (8 figs.).

‡ *Astrophys. Journ.*, iii. (1896) p. 188, 321.

If the diameter of a particle be called e , then we may assume that for photographic resolution it is necessary that the linear distance between the centres of the lines be equal to $4e$. E. C. C. Baly* states that e may be taken as lying between 0.005 to 0.025 mm.; † this statement is not confirmed, however, by other workers. It is not difficult to make slow plates in which the grain does not exceed a diameter of 0.0005 mm. According to Wadsworth, these plates should therefore resolve lines which are not much more than $\frac{1}{10000}$ mm. apart. As rough experiments showed at once that the resolving power of such plates did not exceed about $\frac{1}{20}$ to $\frac{1}{40}$ mm., the author undertook to thoroughly investigate the subject. After numerous experiments, he concluded that: 1. The resolution of a photographic plate is dependent on the amount of irradiation displayed by that plate. 2. That irradiation is not directly proportional to the size of grain, but is caused by two different forms of scatters arising from (a) reflection and (b) diffraction. 3. That the resolving power is likely to be much smaller than that indicated by the theory of Wadsworth.

In order to experimentally determine the resolving power, a series of black and white line gratings were constructed having alternate black and clear lines of equal width, the width of the clear glass ranging from 0.88 to 0.14 mm. Experiments showed that the limit of resolutions possessed by dry plates chemically developed were: For an ordinary fine grained plate, lines will be just resolved if they are separated by 0.018 mm. (For a coarser grain, as in all fast plates, about 0.030 mm. is necessary.) For very fine-grained plates for violet light, 0.018 mm. will be resolved; with red light, 0.008 mm. may be discerned. The resolution on the surface of a fine-grained plate will obviously be much greater than this, as is shown by the very high resolving power possessed by the fine-grained "albumen" plates which are developed by the deposition of silver from an acid silver solution.

Specially prepared gelatin plates of extreme thinness were also prepared, and were found to be more sensitive to red than to blue. The separation with violet light was 0.008 mm.; while with red light lines of 0.004 mm. separation were resolved.

[Photomicrographers will readily appreciate the superiority apparently possessed by red light and medium grains over violet light and fine grain plates. In resolving line tests the former go nearly twice as far as the latter.—Ed.]

Ultramicroscopic Cinematography of Living Microbes and of Moving Particles.†—For carrying out the above purpose, J. Comandon used as light-source an arc lamp of 30 amperes with automatic regulator, the luminous rays being condensed by a thin glass lens in such a way that the image of the positive crater of the arc covered the diaphragm of the Microscope condenser. The Microscope (a Zeiss) was provided with Siedentopf's parabolic condenser giving lateral illumination and thus forming the ultramicroscope. The cinematograph was Pathé's apparatus modified for the purpose, and adapted to the Microscope by the help of a bellows (soufflet). The movement of the film was

* Spectroscopy, p. 339.

† Comptes Rendus, cxxix. (1909) pp. 938-41 (1 pl.).

arranged so that the operator could focus directly on to the sensitive layer. The stop apparatus was synchronous with the descent of the film, and was placed in the luminous beam before the beam reached the preparation. Thus in the intervals of rest the moving particles were no longer submitted to the action of the light and heat of the electric arc. The whole apparatus was operated on an optical bench whose very massive support eliminated vibrations as much as possible. Moreover the apparatus could be arranged at a variable distance from the Microscope.

In order to get exactly the illusion of movement seen in the ultra-microscope, the cinematographic views must be taken at normal rate, that is to say at the rate of sixteen photographs per second, thus giving a pose of $\frac{1}{32}$ sec. for each image. The quantity of maximum light, the film-sensitiveness, the pose time, being quantities almost fixed, the magnification must be varied in order to get the images with optimum illumination. The best results for photographs of blood and its parasites were obtained with a Zeiss 4 mm. apochromat, No. 4 projection ocular, and a film at 0.28 metre from the ocular (plate II.). A magnification of about 280 diameters was thus obtained. In order to get a quantitative measure of the movements of the particles, a rod beating seconds intercepted the luminous ray and thus provided a scale of observation. The author made some very interesting comparative studies of those small mobile blood particles known as Müller's hæmokonies, which were easily counted by this method.

CRABTREE, J. H.—**Formation and Photomicrography of Crystals.**

[A useful article on the method of production, of illumination, and photomicrography of crystals; is well illustrated.]

Knowledge, vi. (1909) pp. 411-14 (10 figs.).

(5) **Microscopical Optics and Manipulation.**

Methods of Determining the Amount of Light Scattered from Rough Surfaces.*—W. F. Barrett, having been consulted in connection with a case of "ancient lights," found it desirable to devise some trustworthy methods for determining the amount of light scattered from large rough surfaces such as the wall of a house. The word "scattered" is to be taken in the sense of "irregularly reflected." Ordinary photometric methods are inapplicable in the case of large surfaces. The author devised the two following methods.

Method A.—This consists of a rapidly revolving opaque disk with a transparent sector which can be altered in size, and whose angular magnitude can be measured (fig. 13). It can be driven by hand, a simple speed-gear being all that is necessary. It is placed at a given distance between the reflecting surface, which is illuminated by the sun or strong artificial light, and the photometer. The width of the sector is altered until equality of illumination between the reflecting surface and a standard source of light is obtained, as shown by some transmission photometer such as Bunsen's, Joly's, or Lummer and Brodhun's. If the scattered light is coloured, as from a brick building, a wedge of suitably coloured glass, or a coloured gelatin film of increasing thickness is gradually interposed in front of the standard light until a similar tint is obtained.

* *Sci. Proc. Roy. Dublin Soc.*, xii. (1909) pp. 190-7 (3 figs.).

Method B.—This consists in reducing the intensity of the stronger light by an absorbing medium. For this purpose the following

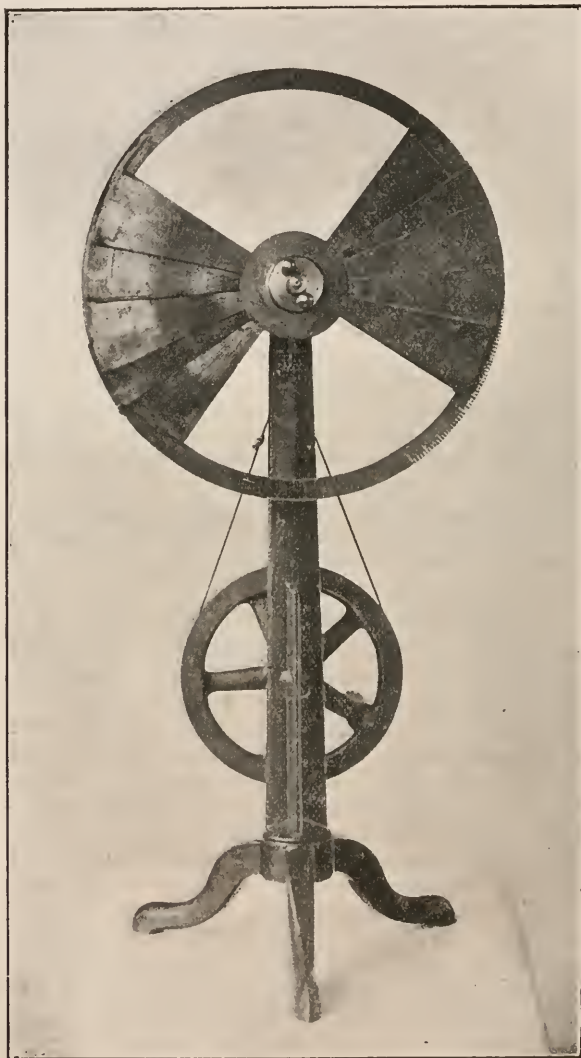

FIG. 13.

arrangement is adopted. It is in principle somewhat similar to the "colorimeter" often used in chemical analysis, and is an adaptation of the method the author recently patented for determining the "light-

threshold" of the eye. The absorbing medium is a liquid of neutral tint, best formed from fine China or Indian ink mixed with water, and

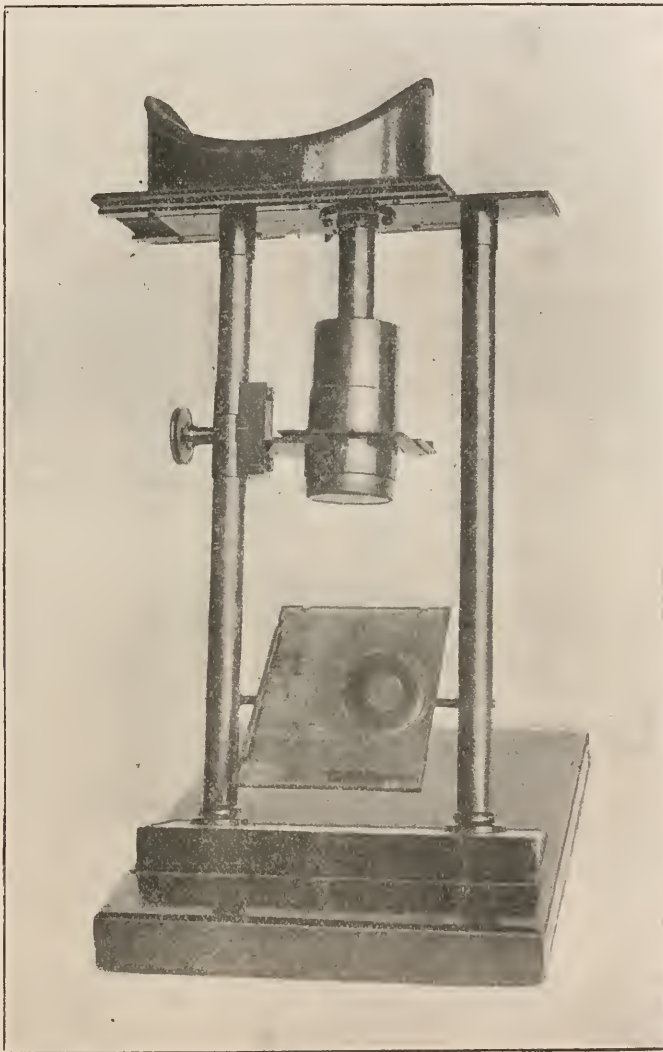

FIG. 14.

allowed to stand for 48 hours; the coarser particles are then deposited, and the supernatant liquid is employed. The apparatus is shown in fig. 14, and, in section, in fig. 15. A variable depth of the liquid is

obtained by the movement of a plunger with glass bottom H (fig. 15) which can be gradually immersed within a cylinder or cistern I, also with a glass bottom, containing the absorbing liquid. Light is reflected upwards through the cylinder by means of a mirror, M, at 45° . The amount of light scattered from various large surfaces can thus be very

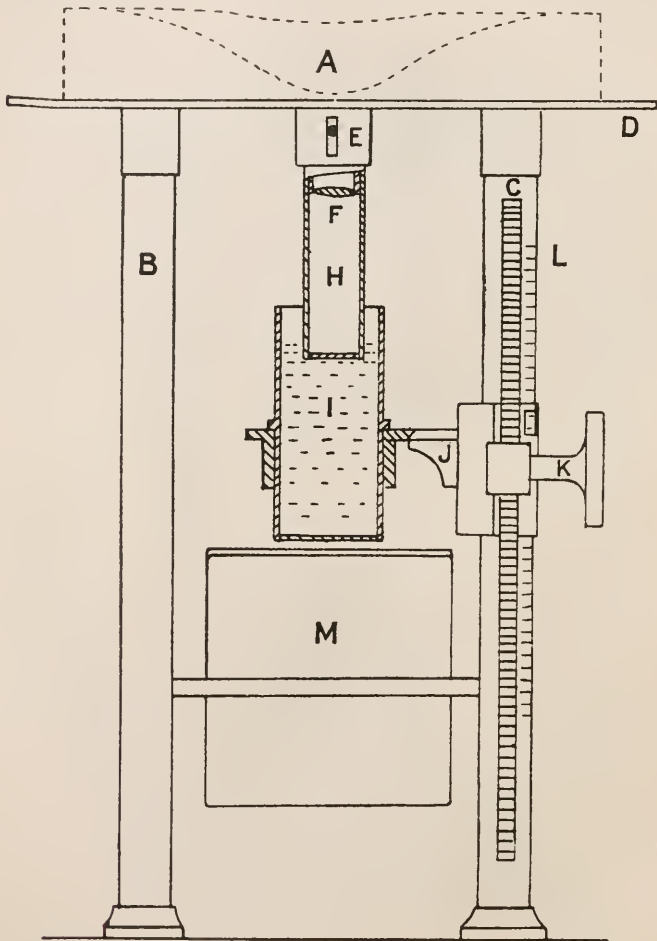

FIG. 15.

easily compared by the relative depths of liquid required to produce extinction. The pillar L is graduated, and the cistern I raised or lowered by the rack-and-pinion K. In order to exclude extraneous light the observer rests his forehead in a shaped head-rest A, and a black cloth covers the head. After one minute the eye attains a fairly steady state, and either eye can be used at pleasure by sliding the head-

rest to and fro. On the glass bottom of H is a minute photograph of the graduated test type used by oculists. This is viewed through a small lens F, adjustable at E, until a sharp image is seen by the observer. When the cistern I is raised until the glass bottom of H and I touch, the scale-reading on L then indicates zero. The depth of the liquid (as indicated on the scale) required to produce complete extinction of the light measures the intrinsic brightness of the source. Or with a constant source of light the depth measures the "light threshold," or the sensibility of the observer's eye to light. This sensibility rapidly rises during the first minute of observation, and becomes nearly constant after two or three minutes. The form sense, or "visual acuity," of the eye is measured by the depth of liquid required to obscure and produce illegibility of the test type, and this also measures the illuminating power of the source of light. The illuminating power of the source may be reduced to any given fraction by means of the adjustable and rapidly revolving sector, or by other means; and it will be found that the depth of liquid required to produce extinction of the light is practically the same, even when the illumination from the source is reduced to a very minute amount; in other words, the intrinsic brightness remains the same. On the other hand, the legibility of the test type varies with the amount of illumination, and it is this we require to measure in the case of light irregularly reflected from rough surfaces. Hence this arrangement affords an accurate method of testing the illuminating power of any surface that scatters light, whether large or small. It is only necessary to use a steady source of artificial light, and note the depth of immersion of the plunger H which is required to produce illegibility when a silvered mirror is employed; then replace or cover the mirror by a similar sized piece of the reflecting surface to be tested, and note the depth now required for extinction, the distance and intensity of the source of light remaining unchanged. The author quotes the following as specimens of his results:—Silvered glass, 100; plane glass surface, 65; ground glass, 45; white card, 45; grey card, 35; dark grey card, 21; smooth black paper, 20; black cotton cloth, 16; dull black woollen cloth, 5.

An Adjustment for the Plane Grating similar to Rowland's Method for the Concave Grating.*—C. Barus states that the remarkable refinement which has been attained (notably by Ives and others) in the construction of celluloid replicas of the plane grating, makes it desirable to construct a simple apparatus whereby the spectrum may be shown, and the measurement of wave-length made in a way that does justice to the astonishing performance of the grating. He has therefore devised an inexpensive contrivance in which the wave-length is strictly proportional to the shift of the carriage at the eye-piece: which for the case of a good 2-metre scale divided into centimetres admits of a measurement of wave-length to a few Ångström units, and with a millimetre scale should go much further. Observations are throughout made on both sides of the incident rays, and from the mean result most of the usual errors should be eliminated by symmetry.

* Proc. Amer. Phil. Soc., xlviii. (1909) pp. 166-76 (5 figs.).

carriage for the mirror or flame, or other source of light whose spectrum is to be examined. A rod *h h* serves to focus *S*. The author gives a full account of the adjustment necessary. He also gives some examples of the satisfactory results obtained.

Wave-length Comparator for Standards of Length.*—A. E. H. Tutton, in describing his instrument for comparing standards of length—the Imperial Standard yard, for instance, with official or other copies—states that it is the most perfect instrument yet devised for measurement of wave-lengths in general. The principle of the instrument is an improved form of the author's interferometer described to the Royal Society in 1898. The essential point of the instrument is that one of the two Microscopes, employed to focus the two defining lines on a standard yard bar, actually carries just above the objective one of the two glass plates of the interference apparatus, which reflect the monochromatic light (hydrogen or cadmium red radiation) which is caused to interfere and produce rectilinear dark bands. When the Microscope is moved the plate consequently moves with it, and the amount of movement is absolutely afforded by the movement of the interference bands, being equal to half the wave-length of the light employed for every band which passes the reference spot in the centre of the field of the interferometer telescope. So perfectly has this fine movement been achieved that the Microscope and the bands can be caused to move simultaneously by rotation of the large fine-adjustment wheel, so steadily that each band can be made to pass the reference spot as slowly as one wishes and be arrested instantly, without the slightest tremor, at any fraction of its width, so that the control of the bands and the counting is a perfectly simple matter.

In order to compare two standard bars it is only necessary (1) to place the bar of known length, supported on an elaborate mechanism for the adjustment of the bars, under the two Microscopes, carried on massive yet delicately moving sliders on a 6-foot V-and-plane bed, so that the two defining lines are adjusted between the spider-lines of the micrometer eye-piece in each case; (2) to replace the standard by the copy to be tested, so that the defining line near one end is similarly adjusted under the corresponding Microscope; then, if the other defining mark is not also automatically adjusted under the second Microscope which carries the glass interference plate, as it should be if it is an exact copy, (3) to traverse that Microscope until it is so adjusted; and (4) to observe and count the number of interference bands which move past the reference spot during the process. The difference between the bars is this number multiplied by the half-wave-length of the light in which the bands are produced. The temperature of the whole room is controlled entirely electrically, being maintained constant at the official temperature, 62° F. (A description of the apparatus will appear later.)

Use of Wave-length Rulings as Defining Lines on Standards of Length.†—The delicacy of the method of measurement in wave-lengths described in the preceding abstract calls for a corresponding refinement in the engraved lines, which form the defining lines of the length of a standard yard or metre or other line-measure bar. The defining lines on

* Proc. Roy. Soc., Series A, lxxxiii. (1909) pp. 79–80.

† Tom. cit., p. 81.

the Imperial Standard yard are sharp-edged, but contain the equivalent of 40 interference bands of red light in their thickness, and the Benoit defining lines of the platinum-iridium copy made in 1902 are not only very ragged edged but contain 15 interference bands in their thickness. By the help of J. H. Grayson, of Melbourne, it has been found that wonderfully satisfactory rulings on the scale of 40,000 to the inch can be made on polished speculum metal covered with a thin cover-glass. Now the forty-thousandth of an inch is a single wave-length of red light (for $H\alpha = \frac{1}{33710}$ in., and Cd red = $\frac{1}{34439}$ in.), so that the interval between any adjacent pair of these lines is equivalent to only two interference bands. The thickness of each line, which is absolutely sharp-edged, is less than a single interference band. The author has therefore devised a "Tutton location signal," consisting of five such parallel lines spaced $\frac{1}{40000}$ in. apart, with a pair of strong "finder" lines outside them and parallel to them, and another pair of similar finder lines, perpendicularly transverse to them, to indicate a central part of the lines lines for use. The central line of the five fine Grayson rulings is the defining line.

POCKLINGTON, H. C.—**The Aberrations of a Symmetrical Optical Instrument.**
 [A mathematical treatment on Lord Rayleigh's article on Hamilton's Principle and the Fine Aberrations of von Seidel.]
Proc. Roy. Soc., Series A, lxxxiii. (1909) pp. 99-106.

(6) Miscellaneous.

Observations on Mammalian Blood with Dark Field Illumination.*—H. Crawley finds that the dark field illumination is a sine qua non for examining fresh blood. The apparatus used consisted of a substage condenser, arc lamp, and rheostat for cutting down the current to 4 amperes. It was found to be important that the slides used should not exceed 1 mm. in thickness. The work was done with a $\frac{1}{2}$ in. achromatic immersion lens stopped down with a hard rubber funnel and a No. 12 compensating eye-piece, though equally good pictures were obtained with a No. 18 eye-piece. The blood studied was that of the cow, sheep, rabbit, guinea-pig, white rat, and man. The blood of sheep and cow was drawn from the jugular vein, defibrinated and preserved in cultured tubes. The media used were bouillon, citrated salt solution, or simple salt solution. Citrated salt solution appears to have a destructive influence on the blood cells after a certain time. It was also noted that the dark field illumination acted injuriously on living cells, and that trypanosomes perished very quickly under its influence. The phenomena observed are treated under the following heads: (1) Blood dust; (2) beaded threads; (3) flagellated erythrocytes and free flagella; (4) bodies showing pseudopodia; (5) erythrocytes; (6) leucocytes; (7) blood plates.

Quekett Microscopical Club.—The 459th Ordinary Meeting of the Club was held on Tuesday, October 26, 1909, the President, Prof. E. A. Minchin, M.A., F.Z.S., in the Chair. Mr. W. Wesché, F.R.M.S., communicated two papers, one "The Life-history of the Tachinid Fly, *Phorocera serriventris* Rondani," and a "Note on a Quick Method of

* U.S. Dep. Agric., Bull. 119, Washington, 1909, pp. 5-15 (1 fig.).

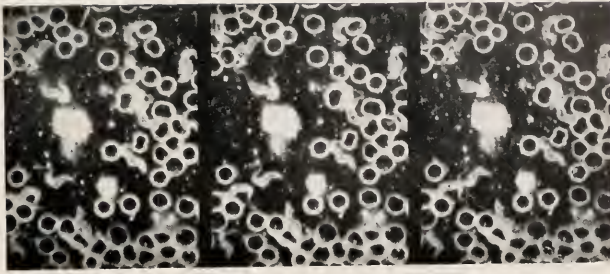

FIG. 1. TRYPANOSOMES IN MOUSE-BLOOD.

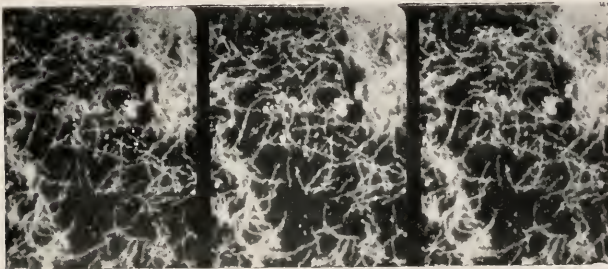

FIG. 2. SPIROCHÆTES OF BALANITIS.



FIG. 3. SPIROCHÆTES IN BLOOD OF FOWL.



Preparing and Staining Pollen." Mr. A. C. Banfield gave a lecture, with lantern illustrations, on "Low-power Photomicrography and Stereo-Photomicrography." Mr. James Murray exhibited some specimens of Rotifers obtained by the 'Nimrod' during Shackleton's Antarctic Expedition.

The 460th Ordinary Meeting was held on Tuesday, November 23. Reference was made to the much-regretted death on November 7 of Dr. W. H. Dallinger, F.R.S., etc., Member and Past President of the Club. The President exhibited and described two preparations of cysticercus of tapeworm, probably *Hymenolepis diminuta*, obtained from rat fleas. Note of a new locality, the second known, for *Zoothamnium geniculatum* was communicated by Mr. J. Stevens, F.R.M.S. Mr. F. P. Smith contributed a "Note on the Mounting of Spider Dissections as Microscopical Objects." Mr. J. S. Dunkerley, B.Sc., gave an interesting résumé of our knowledge of that little-known group of the Protozoa, the Choanoflagellata. J. Clark, in America, was the first to describe the true structure of these forms. A typical Choanoflagellate has an oval, naked, protoplasmic body with nucleus, contractile vacuole, one flagellum, and surrounding the base of the flagellum a protoplasmic membrane—the collar—which is usually basin-shaped. The flagellum arises from a staining granule, the blepharoplast, which apparently was not seen by Saville Kent and other early workers.

B. Technique.*

(1) [Collecting Objects, including Culture Processes.

Two New Methods for Growing Azotobacter in large quantities for Chemical Analysis.†—C. Hoffman and B. W. Hammer describe two procedures by which they have obtained good results.

1. For obtaining a large amount of *Azotobacter* cells an adaptation of the old "pinsel" plate culture method has been employed. In large 8 or 11 in. Petri dishes, $\frac{1}{2}$ in. layer of the specific agar medium is placed; the whole is then sterilised and finally cooled. The plates are then inoculated with a heavy suspension of *Azotobacter* in sterile water, using about 10 c.cm. per plate. This is thoroughly and evenly distributed over the surface of the solidified agar, and the cultures so prepared then incubated. Under these conditions thorough aeration is possible. After the necessary period of incubation the growth, which is very abundant, is carefully scraped off the surface of the agar with a glass slide, removed to an evaporating dish, and prepared for chemical analysis. As much as 1 grm. of dry growth per plate has been obtained in this way.

2. To study the influence of different chemical compounds upon the nitrogen-fixing properties of *Azotobacter*, the authors devised their "sand-slope" culture. This consists in using clean washed and heated quartz-

* This subdivision contains (1) Collecting Objects, including Culture Processes; (2) Preparing Objects; (3) Cutting, including Imbedding and Microtomes; (4) Staining and Injecting; (5) Mounting, including slides, preservative fluids, etc. (6) Miscellaneous.

† Centralbl. Bakt., 2te Abt., xxiv. (1909) pp. 181-3.

sand as follows: in 150 c.cm. Erlenmeyer's flasks, 10–15 gm. of sand are placed, together with 20 c.cm. of the specific liquid-culture medium. The whole is then sterilised, after which the flasks may be inoculated. For inoculation purposes, 1 c.cm. of a heavy suspension of *Azotobacter* in sterile water is used. After inoculation the sand is so sloped that a considerable quantity is above the surface of the liquid culture medium. This slope thus furnishes a solid substratum always well saturated with the culture solution due to capillary action. It further affords optimum aerobic conditions essential for the luxuriant growth of *Azotobacter*.

Cultivation of *Spirochæta gracilis* and *S. balanitidis*.*—C. Levaditi and V. Stanesco cultivated these Spirochætes—the one derived from a chancre, the other from the pus of balanitis—by sowing the microbial flora in a large tube containing horse serum, and three days afterwards inoculating the Spirochætes in a collodion sac filled with horse serum placed within the large tube. In this way the nutritive substances prepared by the microbial flora penetrate the sac, and assure the multiplication of the Spirochætes. Another method was to make stab-cultures in horse or human serum coagulated at 75°. Both these methods produced cultures extremely rich in Spirochætes. These organisms are, however, incapable of assimilating the nutritive substances of the serum without the co-operation of the associated microbes, which are essentially proteolytic. It is only on the third or fourth day after liquefaction of the medium has commenced that *Spirochæta gracilis* and *S. balanitidis* begin to multiply. Thus by making use of a liquefying aerobic bacillus the authors obtained mixed cultures, in which *S. gracilis* multiplied in symbiosis with the bacillus. In this connection it may be pointed out that there is a certain analogy between the culture conditions of Spirochæta and Amœbæ.

Cultivating Meningococcus.†—P. Esch made comparative observations with maltose-ascites-agar, Loeffler's and Buchanan's serums, and with sheep's-blood-maltose-ascites-agar. The last was found to give constant results, and the growth on this medium was very rapid and luxuriant. In from 8 to 12 hours the colonies were evident, and in one instance a vaccine was obtained in 24 hours. The medium consists of 60 c.cm. pepton agar (1 p.c. pepton Witte); to which, after cooling to about 50° C., are added 20 c.cm. sterile defibrinated sheep's-blood, 10 c.cm. ascitic fluid, and 1 gm. maltose dissolved in 3 c.cm. bouillon.

Detection of Bacteria by means of an Electric Current.‡—C. Russ made experiments to ascertain whether bacteria, suspended in an electrolyte, through which a current passes, are transmitted to either electrode, and if so, whether pathogenic organisms could be collected and extracted by such means from pathological fluids. He found that certain bacteria, under the influence of a suitable current, aggregate at one or other electrode. The aggregation varies with the nature of the electrolyte, and is probably due to affinity between the products of electrolysis and the bacteria. The aggregation by electrical

* C.R. Soc. Biol. Paris, lxvii. (1909) pp. 188–90.

† Centralbl. Bakt., 1te Abt. Orig., lii. (1909) pp. 150–1.

‡ Proc. Roy. Soc., Series B., lxxxi. (1909) pp. 314–22 (3 figs.).

currents affords a means of collection and examination. The differences in behaviour of various bacteria are such as to suggest the possibility of utilising the method for purposes of specific discrimination. As an example, the presence of tubercle bacilli in the urine is given. For this, the most suitable electrolyte was ethylamine 5 p.c., 1 part; lactic acid 10 p.c., 4 parts; boric acid 5 p.c., 2 parts; urine, 1 or 2 parts. The apparatus used (fig. 17), consisted of a modified U-tube, filled with a mixture of tuberculous urine and the electrolyte. In the narrow limb of the vessel a platinum foil strip was submerged. In the broad limb a glass tube, traversed by a platinum wire, was submerged, the lower end of the tube forming a bacterial trap. After

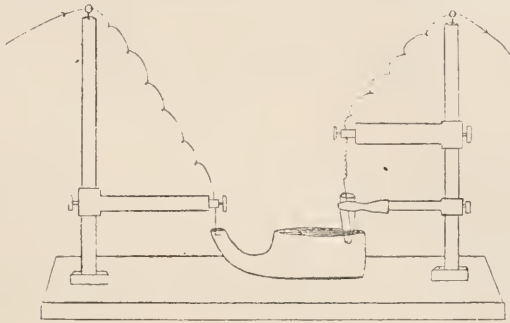

FIG. 17.

passing a current for a sufficient time the contents of the trap were examined in the usual way for tubercle bacilli.

New Method for obtaining Pure Cultures from Whole Organs and Pieces of Tissues.*—A. Feoktistow states that pure cultures of whole organs, e.g. spleen of mouse, or pieces of tissue, may be obtained by immersing the objects in 10 p.c. caustic potash, or soda, for some few seconds, 3 to 8 according to size. The object is then transferred without further preliminary or care to the cultivation medium.

Aerobic Cultures of "Anaerobic" Organisms.†—F. Marino, in a preliminary communication, states that he grows anaerobes in bouillon-serum prepared as follows. Test tubes are filled with a mixture of 5 c.cm. serum and 15 c.cm. bouillon; these are heated for an hour at about 100°. Temperatures much below or much above 100° retard or prevent the development of anaerobes. Any quantity of bouillon-serum may be made provided the relative proportions of 1-3 are maintained.

Cultivating *Spirochæta pallida*.‡—J. Schereschewsky made cultivations on horse-serum. The medium was inoculated with infected material. The spirochaetes were formed on the third day, and from the fifth to the twelfth were very numerous. The best way to examine for

* Centralbl. Bakt., 1te Abt. Orig., lii. (1909) pp. 685-7.

† C.R. Soc. Biol. Paris, lxxvii. (1909) pp. 664-5.

‡ Deutsche Med. Wochenschr., 1909, pp. 1260 and 1652, through Centralbl. Bakt., 1te Abt. Ref., xlv. (1909) pp. 107-9.

them was by removing some of the fluid in a capillary pipette, and then using the dark-ground illumination. Films were made by fixing the smear with osmic acid vapour, and staining with Giemsa's mixture (60 c.cm. of 0.5 p.c. glycerin and a few drops of the Giemsa). The mixture is used hot, and re-applied. Morphologically the spirochaetes bred in this way are indistinguishable from the typical *Spirochaeta pallida*, but they were not pathogenic to animals. Hence these results suggest (1) that the spirochaetes bred are not the true *S. pallida*; (2) that they have lost their virulence; or (3) that syphilis is not due to *S. pallida*.

Collecting Cœlenterata, and Observations on the Ova.*—G. T. Hargitt collected *Tubularia crocea* in November and *Pennaria tiarella* in July and August. The male and female colonies were kept in separate dishes. The medusæ became free about 7 o'clock in the evening. When a sufficient number of eggs had been discharged, spermatozoa were introduced by adding a pipetteful of water from the dish containing the male colonies. In this way the desired stages were easily obtained. To secure stages earlier than fertilisation medusæ were removed from the colony before the time of maturation. The medusæ thus artificially set free were at once fixed, some 15 to 12 hours, others 10 hours, and others at still shorter periods, before liberation.

The following fluids were used for killing:—Flemming's stronger mixture, aqueous solution of sublimate and acetic acid, Bouin's piciformol, Zenker's fluid. For *Tubularia* the corrosive-acetic gave the best results, and for *Pennaria* Bouin's fluid was the most satisfactory. For staining, iron-hæmatoxylin followed by Congo red or orange G: also Conklin's picro-hæmatoxylin, Delafield's and Ehrlich's hæmatoxylin were useful. For purposes of comparison, Mallory's phosphotungstic hæmatoxylin, iron-Brazilin, and Auerbach's and Erlich-Blindi mixtures of acid-fuchsin and methyl-green.

Collecting and Preserving Insects.†—N. Banks, in collaboration with other members of the Bureau of Entomology, U.S.A. National Museum, has compiled a small monograph dealing with the collection and preservation of insects. To those interested in entomology it will be found very useful, as full directions are given for every stage, and these are supplemented with a classification of insects and with special directions for different kinds. The volume is freely illustrated, and a good bibliography is appended.

Modification of the Conradi Medium for Isolating Bacillus typhosus from Excreta.‡—H. B. Fawcens recommends a medium of the following composition. To 900 c.cm. of tap water add 5 gm. sodium taurocholate (commercial from ox-bile); 30 gm. agar (powder); 20 gm. peptone (Witte); 5 gm. common salt. Dissolve in steamer for 3 hours, clean with white of egg, filter through wadding and bring to a reaction of +15 with normal lactic acid or normal soda as required. Dissolve 10 gm. of lactose in 100 c.cm. of distilled water and add it to the melted agar. Mix well and filter through Chardin paper. To

* Bull. Mus. Comp. Zool., liii. (1909) pp. 161-212 (9 pls.).

† Smithsonian Inst., Washington, U.S., Bull. 67 (1909) 135 pp. (188 figs.).

‡ Journ. Roy. Army Med. Corps, xii. (1909) pp. 147-54.

each 100 c.cm. of the clear bile-salt-lactose-agar add 2 c.cm. of 1 in 1000 aqueous solution of brilliant green (extra pure, Grüber) and 2 c.cm. of a 1 p.c. aqueous solution of picric acid. The resulting clear bright green agar is poured into plates 17–20 cm. in diameter. After solidification the plates are dried in an incubator. The bile-salt-lactose agar made in bulk may be distributed into flasks, each containing 150 c.cm. When required for use, one of these is melted and 3 c.cm. of each of the solutions of the dyes added and well mixed. This amount makes three large plates. After inoculation the plates are incubated at 37° upside down. In 24 hours typhoid colonies have a diameter of about 1 mm.; they are quite transparent and clear, while coli have a dark green spot in the centre. These characters are greatly accentuated in 48 hours. Paratyphoid colonies, colonies of the food-poisoning group and of dysentery are indistinguishable in their growth from those of *B. typhosus*. After 48 hours the typical colonies may be fished out and submitted to further examination.

ROSENTHAL, G., & P. CHAZARAIN-WETZEL—*La culture du Bacille perfringens dans les cultures sporulées en eau blanc d'œuf du Bacille anaérobie du rhumatisme aigu; moyen de différenciation des deux variétés du bacille d'Achalmé.* *C.R. Soc. Biol. Paris*, lxxvii. (1909) pp. 677–8.

SINEFF, A., & R. DROSDOWITSCH—*Prof. Dieudonné's Blutkaliagar, ein neuer Nährboden für die bakteriologische Diagnose der Cholera.*

[Confirms the value of this medium for isolating cholera vibrio.

Centrabl. Bakt., 1^{te} Abt. Orig., lii. (1909) pp. 429–31.

See also this Journal, 1909, p. 661.

THAON, P.—*Symbiose de Levure et Oospora dans un cas de langue noire.*

[Gives results of cultivations of these organisms.]

C.R. Soc. Biol. Paris, lxxvii. (1909) pp. 705–7.

(2) Preparing Objects.

Studying the Labyrinth.*—W. Kolmer used monkeys for studying the structure of the internal ear. After the blood had been removed during narcosis the vessels were thoroughly washed out with warm Ringer's fluid. As fixative, Held's fluid was used. This consists of a saturated solution of potassium bichromate, 2 to 3 parts; 10 p.c. formalin, 2 parts; acetic acid, 1 part. In certain instances, trichlor-lactic acid, or trichlor-acetic acid and uranium nitrate, and, for smaller objects, osmic acid, were added. The fixation lasted, according to the size of the object, for from 3 to 10 weeks. Then followed decalcification, with 5 p.c. nitric acid, followed by immersion in lithium sulphate 4 p.c. for one day. After this the pieces were washed in running water, and after passing through upgraded alcohols were transferred in the usual way to celloidin; in this they remained for 8 weeks. The sections were stained with iron-hæmatoxylin, after mordanting with iron-alum; the contrast stain was Rubin.

Studying the Finer Structure of the Labyrinth of Vertebrata.†
H. Held, when examining the development of the organ of Corti and of

* *Arch. Micr. Anat. u. Entwickl.*, lxxiv. (1909) pp. 259–310 (4 pls.).

† *Abhandl. k. Sächsisch. Gesell. Wissensch.*, xxxi. No. 5 (1909) 294 pp. (18 pls.).

the macula acustica in mammals and birds, fixed the material in a mixture of chromic acid, acetic acid, and formalin; the sections were stained by the molybden-haematoxylin method, and after-stained with erythrosin, with acid rubin or with picro-fuchsin.

Studying Development of Red Blood Cells in the Chick.*—C. Price-Jones prepares films of bone marrow, spleen, liver, and embryonic tissue in the following manner. Small portions of the specimen are transferred to a watch-glass containing a dissociating reagent: in this way an emulsion of cellular elements is obtained. The dissociating solution consists of glycerin, diluted with ammonia-free distilled water to form a 10 p.c. neutral solution, titrating against decinormal sodium hydrate, and using phenol-phthalein as indicator. The initial acid reaction of this solution should vary from +0.1 to +0.5 (Eyre's Scale); the reagent has a specific gravity of 1029 at 15.7° C. A loopful of this glycerin solution is placed on a coverslip, and to this is added a loopful of the emulsion in the watch-glass, and very gently spread over the surface of the slip. The film thus prepared is allowed to dry in the air, without heating, until a uniform ground-glass appearance is produced. The film is then treated as a blood-film; it is stained with Jenner's solution of rosinate of methylen-blue, and then, after washing in ammonia-free distilled water and completely drying in the air, is mounted in balsam.

Demonstrating Motor End-plates.†—J. Boeke in his study of the motor end-plates in the higher Vertebrata, their development, form and connection with muscle fibres, used Bielschowsky's method. Fixation of embryos in alcohol-formalin was preferable to aqueous formalin, and the following mixture was used: formalin 10 parts, alcohol 60 p.c. 90 parts. After fixation the alcohol is removed by immersion in 10 to 12 p.c. formalin, and then the pieces of tissue are placed in 2 p.c. silver solution for 3 to 5 days in the dark. On removal they are washed in distilled water and then transferred to Bielschowsky's fulminate of silver solution for 1 to 2 hours, and subsequently reduced in 20 p.c. formalin. The pieces are afterwards imbedded in paraffin in the usual way.

Researches on Blood and Connective-tissue. —A Maximow examined the embryos of rats, cats, rabbits, mice, and guinea-pigs. The tissue was fixed in formol-Zenker. Small embryos up to 12 mm. in length were immersed in toto in the warm fluid; larger ones were incised to facilitate the entrance of fluid. The fixation lasted from 3 to 5 hours, after which the objects were washed and then placed in upgraded iodine-alcohols, and when dehydrated were imbedded in celloidin. Serial sections were stained with cosin-azur or with Giemsa. Iron-haematoxylin was not so useful.

Hardening and Imbedding the Eggs of *Temnocephala fasciata*.‡
The difference in consistence between the eggshell and the contents gives

* Journ. Pathol. and Bacteriol., xiv. (1909) pp. 218-23 (1 pl.).

† Anat. Anzeig., xxxv. (1909) pp. 193-226 (40 figs. in text and 1 pl.).

‡ Arch. Mikrosk. Anat. u. Entwickl., lxxiv. (1909) pp. 525-621 (3 pls.).

§ Quart. Journ. Micr. Sci., liv. (1908) pp. 417-18.

rise to considerable difficulties. If the contents are in the fresh condition, they burst out and become completely disorganised when the thick shell is broken through. If hardened in the ordinary way, the yolk becomes exceedingly hard and brittle. W. A. Haswell has overcome these difficulties in the following way: The eggs are fixed with sublimate alcohol followed by iodised alcohol and 90 p.c. alcohol. After hardening, they are transferred to a solution of hypochlorite of soda. This transference is effected gradually through downwardly graded alcohols. If this be done too rapidly, the shell will split.

When the solvent action of the hypochlorite upon the cells has proceeded far enough, the eggs are washed in distilled water and dehydrated in alcohol. From absolute alcohol, they are transferred to a mixture of equal parts of absolute alcohol and anhydrous ether for twenty-four hours. They then remain for a like period in $\frac{1}{2}$ p.c. solution of photoxylin or celloidin in equal parts of absolute alcohol and ether, followed by a $2\frac{1}{2}$ p.c. solution of the same. The celloidin blocks, hardened in chloroform, are then finally imbedded in the hardest paraffin in the usual way.

(3) Cutting, including Imbedding and Microtomes.

Studying the Development of Amphioxus.*—The material at the disposal of E. W. MacBride for this research consisted of a large number of eggs, embryos at all stages, from the spherical blastula up to the period when the mouth, club-shaped gland, and one gill-slit have been formed, and a number of older larvæ. The material was preserved for the most part in corrosive sublimate and in osmic acid. The author considers that osmic acid is beyond comparison the best reagent for the preservation of histological detail. When yolk is abundant, osmic acid makes the material very brittle, so that for studying the stages of gastrulation, material preserved in picrosulphuric acid and in corrosive sublimate and acetic acid was used. But osmic acid material was exclusively employed in all later stages.

For imbedding the embryos, MacBride used the following modification of the celloidin and paraffin method: The celloidin containing the embryos, after being congealed in chloroform, was transferred to cedar oil. In this oil it became as clear as glass, so that the imbedded embryo could be observed under the microscope, and its orientation determined. An appropriately shaped piece of celloidin was then cut out and imbedded in paraffin. The sections were stained on the slide.

Demonstrating Peripheral Nerve Terminations.†—R. C. Mullenix, when studying the peripheral termination of the eighth cranial nerve in Vertebrates, adopted Bielschowsky's method of impregnation. The head of a recently killed fish was immersed in 12 p.c. formalin for at least 24 hours; the fixed material was next decalcified in 12 p.c. formalin containing 1 p.c. nitric acid. After about 24 hours the acid was removed by means of running water. The material was then transferred to 2 p.c. silver nitrate for 24 hours or so, after which it was removed to an

* Quart. Journ. Micr. Sci., liv. (1909) pp. 290-1.

† Bull. Mus. Comp. Zool. Harvard, liii. (1909) pp. 215-50 (6 pls.).

ammoniacal solution of silver oxide. This was prepared by adding to 2 p.c. silver nitrate a few drops of 40 p.c. solution of sodium hydroxide, and dissolving the precipitate with ammonium hydroxide. After a period varying with the nature of the material, the pieces were washed, and then transferred to 20 p.c. formalin. After 12 hours the preparation was dehydrated, cleared, imbedded in paraffin, sectioned, and mounted in balsam in the usual way. The foregoing method was found to be superior to all others, such as those of Golgi, Ramón y Cajal, Vom Rath, etc.

New Method of Staining the Connective-tissue Framework of Viscera.*—D. Timofejew makes freehand or frozen sections of organs of freshly killed animals, or of pieces which have been immersed in physiological salt solution for one day. The sections are placed for 15 to 20 minutes in the following solution:—Methylen-blue (Ehrlich rectified) 1 gm., physiological salt solution 2000–4000 c.cm. The sections do not harm if left in the staining fluid for 24 hours. On removal the sections are carefully washed in salt solution, and then transferred for $\frac{1}{2}$ to 1 hour, or even 24 hours, to a very weak solution of ammonium picrate (0.1 gm. ammonium picrate in 800–1200 c.cm. of physiological salt solution). The differentiation takes place in a few minutes, and its progress may be watched under a low power. The sections are mounted in the following fluid:—Saturated aqueous solution of ammonium picrate 35 c.cm., glycerin 50 c.cm., and distilled water 50 c.cm. In case the nuclei are not sufficiently stained, the preparation may be treated with Hoyer's picrocarmin. After-staining with Cajal's mixture of indigo-carmin and picric acid stains the collagen green, the other tissues remaining violet. A lengthy description of the appearances in different organs is given.

(4) Staining and Injecting.

New Method of Demonstrating the Spores in Acid-fast Bacteria.† L. von Betegh makes use of a stain made up as follows: 2 gm. of pure dahlia are dissolved in 20 gm. of 95 p.c. alcohol; to this are added 50 gm. of distilled water and 4 or 5 drops of strong carbolic acid. L. von Betegh's process consists of the following steps: Stain with warm carbol-fuchsin as usual; wash; stain with dahlia two or three minutes at room temperature; wash; stain with iodine solution (iodine 1 gm. potassium iodide 2 gm. distilled water 100 c.cm.) 10 to 15 minutes; wash in alcohol-acetone until no more stain comes away; wash; counterstain with picric acid or malachite-green; wash; dry, and mount. By this method, the author shows that acid-fast bacilli contain spores which are not acid-fast. He considers that some such method should be employed in routine examinations for tubercle bacilli.

Methods of Demonstrating the Flagella and Minute Structure of Spirillum volutans.‡—F. Fuhrmann investigated living spirilla on a dark ground, using Reichert's mirror-condenser. To keep spirilla at rest for this mode of examination, he prepared a fine film of the thin bacterial

* Anat. Anzeig., xxxv. (1909) pp. 295–301.

† Centralbl. Bakt., 1^{te} Abt., lii. (1909) pp. 550–3.

‡ Op. cit., 2^{te} Abt., xxv. (1909) pp. 129–35.

emulsion, dried this quickly in air, added a droplet of water, and applied a coverslip carefully. This was then ringed with paraffin to prevent evaporation.

The author obtained good results by using a solution containing 3 grm. of iodine and 3 grm. of potassium iodide in 20 c.cm. of water. A small drop of the fine emulsion of spirilla was placed on a clean slide, and to this a larger drop of iodine solution was added. A coverslip was then placed in position, and ringed with paraffin.

For demonstrating minute cellular structure and the intracellular connections of flagella, the organisms were fixed in corrosive sublimate, or in weak Flemming's solution. The bacterial emulsion was placed in a filter-paper folded in the usual way in a filter funnel. The fixing fluid caused the organisms to cohere in clumps, so that none passed through the filter-paper. Alcohols of mounting strengths were added, and then xylol and xylol-paraffin. Finally, the organisms were imbedded in paraffin, fine sections ($2-4\ \mu$) were cut and stained with methylen-blue or methylen-green.

New Staining Reaction for Tubercle Bacilli.*—D. Gassi stains the fixed smears in a warm solution of eosin for one or two minutes. The solution consists of 1 p.c. eosin solution, to 5 c.cm. of which a crystal of sublimate the size of a lentil has been added. After washing in water the smear is treated with a mixture of 0.5 NaHO, 1 potassium iodide, 100 of 50 p.c. alcohol, until it assumes a pale green hue, after which it is further treated with alcohol and afterwards washed in water. The preparation is next contrast-stained with acid methylen-blue for 2 or 3 seconds (methylen-blue 1, absolute alcohol 10, $\frac{1}{2}$ c.cm. hydrochloric acid and 90 c.cm. distilled water). After a thorough wash it is dried and mounted. The tubercle bacilli are red, the rest blue. By this method tubercle can be distinguished from smegma bacilli, as the latter are not alkali-fast.

Demonstrating the Presence of Lipoids in Cells.†—C. Ciaccio recommends the following procedure:—1. Pieces a few millimetres thick are fixed in Ciaccio's fluid for 24 to 48 hours (5 p.c. bichromate of potash, 100 c.cm.; formalin, 20 c.cm.; formic acid, 4 or 5 drops, or acetic acid, 5 c.cm.). 2. Immersion of the pieces in 3 p.c. bichromate for a week. 3. Washing in running water for 24 hours. 4. Upgraded alcohols for 24 hours; absolute alcohol, 2 hours; absolute alcohol and sulphide of carbon (or xylol or chloroform), 1 hour; sulphide of carbon, 1 hour; paraffin, m.p. 60° , dissolved in sulphide of carbon at 37° , 1 hour; paraffin, m.p. $55-60^\circ$, 1 hour. The sections are stuck on the slide by Henneguy's method (very dilute solution of gelatin in tepid distilled water, with a crystal of potassium bichromate added). The sections are then stained with an alcoholic solution of Sudan iii. for 30 to 45 minutes, or with scarlet R. Excess of stain is then removed with 50 to 60 p.c. alcohol. The sections may then be contrast-stained with hæmatoxylin, water-blue, crystal-violet, etc., and are imbedded in Apáthy's gum and syrup medium. In some cases the following

* Centralbl. Bakt., 1^{te} Abt. Ref., lxiv. (1909) p. 758.

† Anat. Anzeig., xxxv. (1909) pp. 17-31.

procedure is successful: (1) Fix in Ciaccio's fluid; (2) bichromate for about a week; (3) Marchi's fluid for 24 to 48 hours, followed by bichromate for 48 hours; (4) the rest of the procedure is as before. By the first method, ordinary fats are dissolved, while the lipoids (myelin sheath, adrenal, etc.), are picked out in orange-red by Sudan iii. By the second method it is occasionally possible to demonstrate the co-existence of fat and lipid in the same cells, a black centre with a red or brownish-red margin or halo.

Modification of Gram's Method of Staining.*—S. Stephan describes a modification of the Gram procedure, which is specially useful for staining sections. The alcohol-fixed sections are stained in carbol-water-methyl-violet 6 B solution for 10 minutes to 1 hour or more. On removal they are washed in water, and then immersed in the following mixture, freshly prepared before use: 10 p.c. ferricyanide of potash 1, and 5 p.c. potassium iodide, for 10 minutes. After washing in water, the sections are thoroughly decolorised in absolute alcohol. They may now be contrast-stained with dilute carbol-fuchsin or eosin, and afterwards mounted in balsam.

Staining Eosinophilous Cells.†—L. Martinotti finds that absolute methyl-alcohol is the best fixative for smears, and that ether-alcohol (equal parts) and heat are also very good for the purpose. For fixing pieces the best fluids are sublimate, formalin, and methyl-alcohol. The author's formula for sublimate is as follows:—Sublimate, 21 gm.: alcohol, 95–100 p.c., 150 c.cm.; physiological saline, 279 c.cm.; acetic acid, 150 c.cm. For staining the granules in sections some of the eosins must be used, and from these are picked out the bluish-eosin, the pure French-eosin, and the extra-eosin Höchst, all obtained from Grübler. The preparations may be contrast-stained with methyl-eosin, safranin, or cochineal. For staining the granules on smears the eosin-methylen-blue mixture of Jenner and of May-Grünwald are recommended. A copious bibliography is appended.

(6) Miscellaneous.

Burri's Indian-ink Method.‡—A. A. Gins finds that this method is very satisfactory for demonstrating micro-organisms, blood-plates, etc. A film is made of a mixture of the ink and the material to be examined just after the manner of a blood-smear. The method is also adapted for enumerating bacteria in a suspension. Eight photographs show organisms clearly depicted on a dark ground. The ink-smears may be after-stained, e.g. with Giemsa's solution. For making the films a smearer like Wright's is used; the author described the procedure for making a smearer out of a slide.

* Centralbl. Bakt. 1te Abt. Orig., li. (1909) pp. 94–6.

† Zeitschr. wiss. Mikrosk., xxvi. (1909) pp. 4–28.

‡ Centralbl. Bakt., 1te Abt. Orig., lii. (1909) pp. 620–5 (4 pls.).

Metallography, etc.

Copper-tin Alloys.*—F. Giolitti and G. Tavanti have re-determined the equilibrium diagram of this system, using thermal and microscopical methods. The diagram is regarded as being composed of two distinct parts, corresponding to alloys of the compound Cu_3Sn with copper and with tin respectively.

Silver Coinage Alloys.†—E. Pannain has investigated microscopically the effect of working upon a coinage alloy containing 83.3 p.c. silver and 16.5 p.c. copper. The alloy, etched with concentrated nitric acid, is observed to consist of white crystals of a solid solution of copper in silver, surrounded by a dark eutectic. The crystals become elongated by rolling; annealing tends to restore the regularity of structure. The actual coining breaks up the crystals and produces a structure sufficiently distinct from that of cast metal to permit of the detection of some false coins by microscopic examination.

Aluminium-copper-tin System.‡—J. H. Andrew and C. A. Edwards have determined the liquidus curves of this ternary system. A diagram of the well-known equilateral triangle type is given, representing the results of freezing point determinations of more than 400 alloys. Each isothermal line passes through points indicating the composition of alloys having the same freezing point. The diagram is held to demonstrate that no ternary compound is deposited from any of the liquid alloys, and that no true ternary phase appears to form above the solidus. The compound Cu_3Al is remarkably stable. Homogeneous solid alloys containing more than 16 p.c. tin and 12 p.c. aluminium could not be obtained, excessive segregation occurring. Some of the alloys separate, in the liquid state, into tin and a copper-aluminium mixture.

Lead and Tin Alloys.§—A. E. Dunstan finds that a wire of lead or tin, or an alloy of these metals, loaded in tension beyond its elastic limit, extends at a steady rate. A "viscous flow" takes place. For any given load a coefficient of viscous traction may be deduced from the rate of flow. While the effect of tin on the mobility of lead is great, the effect of lead on the mobility of tin is small.

Brass and Copper.||—The effect of cold working and annealing upon the tensile properties and microstructure of brass containing 67 p.c. copper, 33 p.c. zinc, has been exhaustively studied by Gard. A numerical expression of degree of cold working is given by $\frac{100(S-s)}{s}$, S being the area of cross-section of the original fully annealed strip, s the area of cross-section of the strip after cold-rolling in the direction of its length. The effect of temperature and time of annealing was determined on strips cold worked to 125 on the above arbitrary scale. Annealing below 275°C . has little effect; between

* *Gaz. Chim. Ital.*, xxxviii. (1908) pp. 209-39, through *Journ. Soc. Chem. Ind.*, xxvii. (1908) p. 1155.

† *Atti R. Accad. Lincei*, xviii. (1909) pp. 523-5, through *Journ. Chem. Soc.*, xvi. (1909) p. 731.

‡ *Proc. Roy. Soc.*, Series A, lxxxii. (1909) pp. 568-79 (9 figs.).

§ *Phil. Mag.*, xvii. (1909) pp. 192-201.

|| *Rev. Métallurgie*, vi. (1909) pp. 1069-1113 (69 figs.).

275° and 350° C. the elongation greatly increases and tensile strength falls off. The effect of annealing is in the same direction, but is more gradual from 350°–750° C. Little change takes place from 750°–830° C.; at higher temperatures the brass deteriorates. Corresponding changes in microstructure are a rapid recrystallisation between 275° and 350° C., followed by a growth of size of crystal at higher temperatures. Similar investigations were carried out on brass containing 90 p.c. copper, and on pure copper. The etching solutions used were:—

	For 67/33 Brass.	For 90/10 Brass and pure Copper.
Water	100 c.cm.	100 c.cm.
Hydrochloric acid	6 "	50 "
Ferric chloride	19 grm.	5 grm.

Iron Alloys.*—C. F. Burgess and J. Aston tabulate the forging, welding, and machining properties of alloys of iron with some seventeen other elements. The alloys, which contained so little carbon that its influence might be neglected, were prepared by melting together electrolytic iron containing about 0·03 p.c. of impurities, and the alloying element, in weighed quantities. In the nickel, copper, cobalt, tungsten, molybdenum, chromium, manganese and silicon series there was a general agreement between the weights used and the percentage composition of the resulting alloy. Silver, selenium, aluminium and lead do not alloy at all in the proportions added. Although arsenic and tin vaporise at temperatures much below the melting point of iron, considerable amounts of these elements remained in the alloy.

Iron-manganese Alloys.†—C. F. Burgess and J. Aston give diagrams and tables showing the effect of increasing manganese content upon the permeability and other magnetic properties of iron-manganese alloys prepared from pure electrolytic iron. The tests were made on the material (1) as forged; (2) annealed at 675° C.; (3) annealed at 1000° C.; (4) quenched from 900° C. The permeability falls as the manganese content increases.

Iron-copper Alloys.‡—C. F. Burgess and J. Aston have determined some mechanical properties of a series of alloys, prepared from electrolytic iron and electrolytic copper. An alloy containing 1·5 p.c. copper appears to be a promising material. Segregation was not observed in the alloys containing 0–8 p.c. copper.

Steels for Gears.§—L. Révillon gives, in addition to the results of practical tests of gears, much information as to the thermal critical points, heat-treatment and mechanical tests of 26 steels, most of which contained nickel and chromium in varying proportions.

Special Steels.||—W. Giesen deals with a variety of subjects related to alloy steels. Great importance is attached to nitrogen content. The critical nitrogen content lies between 0·037 and 0·041 p.c. for carbon steel, that is the point at which no elongation is obtained in tensile

* Electrochem. and Met. Ind., vii. (1909) pp. 436–8.

† *Tom. cit.*, pp. 476–8 (4 figs.).

‡ *Tom. cit.*, pp. 527–9 (2 figs.).

§ Rev. Métallurgie, vi. (1909) pp. 1024–53. Iron and Steel Inst. Carnegie Scholarship Memoirs, i. (1909) pp. 161–218 (12 figs.).

|| Iron and Steel Inst., Carnegie Scholarship Memoirs, i. (1909) pp. 1–59 (2 figs.).

tests. The thickness of carburised layer obtained by case-hardening at different temperatures for various lengths of time was determined for steels containing as the alloy element, nickel, titanium, silicon, manganese, chromium, tungsten, and molybdenum. The results of much other experimental work are given, but it is difficult to ascertain whether the numerous and varied statements made by the author are conclusions drawn from his own work or are based upon other published investigations.

Special Ternary Steels.*—A. M. Portevin has carried out shearing tests by the Frémont method, and tensile tests, on a large number of alloys of iron and carbon with a third element. The electrical resistance of the steels was also determined, and the relations between electrical resistance, chemical composition, micro-structure and heat-treatment were investigated. The steels used contained as third element manganese, nickel, chromium, tungsten, vanadium, aluminium, silicon, molybdenum, titanium, tantalum and boron, and were the steels of which other properties had been determined by Guillet. It does not appear possible to express the relation between tensile and shearing properties by any general formulæ. For a given series of alloys, the curve showing the relation between proportion of third element and electrical resistance is made up, as a rule, of several rectilinear portions, and the inflections in the curve correspond with changes in micro-structure. The thermal critical points of a number of vanadium and titanium steels were determined. A bibliography is appended.

Iron-carbon Diagram.—F. Wüst† gives an historical account of the development of the equilibrium diagram of the iron-carbon system, and states the experimental evidence on which he finds the following conclusions. Carbon is not dissolved in molten iron as elementary carbon, but as carbide of iron. "Kish" is formed by the decomposition of the carbide which crystallises from the fluid solution. The solidification of iron-carbon alloys does not take place according to the equilibrium curves, which apply only to the stable system. Graphite is formed by the decomposition of separated carbide. Elements present other than iron and carbon have both a direct and an indirect influence on graphite-formations: (*a*) direct, in that they enter into the composition of the carbide, and either increase its rate of decomposition (silicon, nickel, aluminium) or decrease it (manganese, chromium, tungsten); (*b*) indirect, in that the solubility curve of iron carbide in solid or liquid iron is displaced, and the quantity of separated free carbide is correspondingly greater or smaller. The carbide is decomposed in solid alloys by the action of heat. The influence of foreign elements on the temperature at which temper carbon is set free has the same explanation as in the case of graphite formation.

P. Goerens‡ deals very fully with ternary systems consisting of iron, carbon, and a third element. As an example to illustrate methods of investigating and representing ternary equilibriums, the lead-tin-bismuth system is selected. A model showing the diagram in solid form may be constructed from sheets of transparent celluloid, each representing a section through the diagram, erected perpendicular to a triangular base

* Iron and Steel Inst., Carnegie Scholarship Memoirs, i. pp. 230-364 (67 figs.).

† Metallurgie, vi. (1909) pp 512-31 (19 figs.).

‡ Tom. cit., pp. 531-6, 537-50 (46 figs.).

any point in which represents the composition of an alloy. The diagram of the iron-manganese-carbon system is shown in this manner. The iron-phosphorus-carbon system, considered as a ternary system the components of which are iron, iron phosphide and iron carbide, resembles the lead-tin-bismuth system. Alloys of iron and carbon with a third element follow one of two types:—1. The iron-carbon-manganese system. The third element forms solid solutions with both γ -iron and iron carbide. Systems following this type are Fe-Cr-C, Fe-W-C, Fe-Ni-C, Fe-Si-C. 2. The iron-carbon-phosphorus system. The third element forms a chemical compound with iron, and the compound is insoluble in iron carbide, and insoluble or partly soluble in γ -iron. To this type belong Fe-P-C, Fe-Sn-C, Fe-As-C, Fe-Sb-C.

Useful bibliographies are appended to both these papers.

Cementation by Carbon.*—L. Guillet and C. Griffith have made careful cementation experiments on iron and low-carbon steel. Samples buried in powdered purified sugar-carbon and heated at 1000° C. in a porcelain tube in which a vacuum was maintained showed a small increase in carbon content, but when the metal and carbon were both previously heated separately to expel occluded gases, a similar "cementation" gave no increase in carbon. The effect of pressure, slight or great, was also studied. The chemical analyses were checked by microscopic examination, which gave information as to the distribution of carbon absorbed by the metal. The authors conclude that pure carbon cannot be absorbed by iron when heated in a vacuum, unless contact be assured by mechanical means, or dissolved gases be present. Cementation increases with increase of pressure.

Constituents of Steel.—The definitions adopted by the Copenhagen Congress of the International Association for Testing Materials† are given. A "metaral" is a chemically homogeneous constituent, an "aggregate" is a chemically heterogeneous constituent. The metarals are ferrite, graphite, cementite, austenite, and martensite. Pearlite, and possibly osmondite, are aggregates. Martensite is defined as a solid solution of carbon and iron, not stable at any temperature, distinguishable from austenite by its greater hardness and magnetic permeability.

H. le Chatelier‡ discusses the definitions, and explains the replacement of the name "troostite" by "osmondite," and the omission of "sorbite."

F. Osmond§ does not agree to the abandonment of "sorbite" and the replacement of "troostite" by "osmondite."

Metallography of Iron.—H. M. Howe considers that the results obtained by Baykoff¶ have made possible a simplification of the theory of the iron-carbon system. The needle structure of martensite now appears to be characteristic of β -iron, not of a crystallitic form of γ -iron. The author collects the evidence that the martensite needles represent a stage intermediate between γ - and α -iron. The specific volume, brittleness and hardness corresponding to the needle structure are all greater

* Rev. Métallurgie, vi. (1909) pp. 1013-23 (3 figs.). † Tom. cit., pp. 1122-3.

‡ Tom. cit., pp. 1124-6, 1366. § Tom. cit., pp. 1183-7, 1363-5.

¶ Electrochem. and Met. Ind., vii. (1909) pp. 423-7 (5 figs.).

¶ See this Journal, 1909, p. 669.

than those of γ - or α -iron. It is, therefore, improbable that the martensite needles can be merely a mixture of α - and γ -iron.

Transformations of Iron and Steel.*—Grenet holds that the transformation of iron, and the solution of carbon in iron, are not two separate and distinct phenomena. When carbide of iron goes into solution in iron, the iron changes from the α to the γ condition. The case of pure iron undergoing the change from α to γ is the limiting case, the concentration of carbon in the γ solid solution formed being nil. Assuming the stability of cementite, the only phases occurring in the iron carbon system in the temperature range -180° C. to $+1200^{\circ}$ C., and the concentration range 0 to 1.60 p.c. carbon, are ferrite, cementite, and solid solution.

Hardness of Steel.†—Grenet has sought to determine if the effect of annealing quenched or cold worked steel reaches a limit for any given temperature. Small pieces of a hard carbon steel and a nickel chromium steel were quenched in water from 800° C. and heated for various lengths of time, up to 64 hours, at 300° , 500° , 650° , and 675° C. Hardness was determined by the Brinell method. The annealing effect at 300° C. was practically complete after 15 minutes. At 500° , 650° and 675° C., the effect was not complete after 16 hours, though after four hours the action was very slow. Variation in temperature of annealing has a relatively much greater effect than variation in length of time.

Use of Metallic Deposits in Metallography.‡—F. Giolitti has applied the method of depositing thin layers of metal on the polished surface of an alloy by immersion in a solution of a metallic salt, to the study of solid solutions. Indications of the heterogeneity of solid solutions may thus be obtained. The method has been employed in the study of bronzes.

Rate of Change in Alloys.§—G. D. Bengough describes a method of determining the rate of change in metastable solid alloys when heated. Portions of the alloy are heated at a selected temperature for various lengths of time, and quenched in water. Photomicrographs are taken and enlargements on bromide paper are made. The relative proportions of the phases present are determined by cutting them out and weighing the paper.

Surface-flow in Calcite.||—By a development of the method of step-by-step etching, G. T. Beilby has shown that the disturbance of the surface of calcite by polishing penetrates to a depth of 500 to 1000 μ . The method of etching consists in placing on the polished surface a drop of water containing a minute and known quantity of hydrochloric acid. A known quantity of calcium-carbonate is thus dissolved, and the depth removed by a number of successive etchings is calculated. By illuminating by the nearly critical image of the sun, the author detected a roughen-

* Bull. Soc. Chim., v. (1909) pp. 758-64 (4 figs.).

† Rev. Métallurgie, vi. (1909) pp. 1054-9 (3 figs.).

‡ Gaz. Chim. Ital., xxxviii. (1908) pp. 352-7, through Journ. Chem. Soc., xciv. (1908) pt. 2, p. 945.

§ Journ. Soc. Chem. Ind., xxvii. (1908) pp. 752-3.

|| Proc. Roy. Soc., Series A, lxxxii (1909) pp. 592-605.

ing of the surface, caused by etching, calculated to be not more than 2 molecules in depth. The unetched polished surface shows no trace of disturbance, and the presence of a disturbed surface layer is revealed only by etching. The disturbed layer seems to have a different molecular structure, and is harder than the original crystal. The presence of this protective skin does not interfere with the parallel growth of crystals of sodium-nitrate on the polished surface.

Testing of Galvanised Metals.*—W. H. Walker, in discussing methods of determining the resistance to corrosion of zinc-coated metals, describes their microscopic structure. Between the outer coating of zinc and the iron base are a number of zinc-iron alloys.

Magnetic Transformation of Nickel and Cobalt.†—I. I. Shukoff finds that sudden changes occur in magnetic properties, electrical conductivity and thermo-electric properties, at about 340° C. for nickel and 1000° C. for cobalt. A heat effect was observed with cobalt at 985° C. by the differential method of taking cooling curves, but no such effect was observed with nickel between 600° and 180° C. The author concludes that the transformation observed in nickel depends on some change occurring in the internal structure of the atom.

Testing by Alternating Stress.‡—H. le Chatelier discusses the relation between the behaviour of a metal under A. Guillet's vibratory test§ and its resistance to alternating stresses. Perfect elasticity is unknown. However small the deformation, a piece of metal, when the stress is removed, does not return completely to its original form, but remains deformed to a slight degree. A part of this slight remaining distortion disappears slowly, but an exceedingly small permanent deformation remains. In the slow recovery towards its original form, the metal exhibits viscosity, and this is the property which the Guillet "damping" test appears to reveal.

Gases Occluded in Steel.||—T. Baker has determined the composition and volume of the gases evolved by two crucible steels, containing respectively 0.81 and 0.90 p.c. carbon, when heated in vacuo. A little aluminium had been added to the second steel before casting, none to the other. More than 97 p.c. (by volume) of the total gas evolved was hydrogen and carbon monoxide, and the sound steel, to which aluminium had been added, evolved twice as much gas as the steel containing blow-holes.

SANG, A.—Cementation.

[Theories of various cementation processes are discussed, and methods described.] *Electrochem. and Met. Ind.*, vii. (1909) pp. 485-7, 532.

VANSTONE, E.—Miscibility of Solids.

[The theory of the formation of solid solutions is discussed, and the results of experimental work on various organic bodies are given.]

Journ. Chem. Soc., xcv. (1909) pp. 590-604 (3 figs.).

* *Electrochem. and Met. Ind.*, vii. (1909) pp. 440-2.

† *Journ. Russ. Phys. Chem. Soc.*, xl. (1908) pp. 1748-52, through *Journ. Chem. Soc.*, xcvi. (1909) pp. 209-10.

‡ *Rev. Métallurgie*, vi. (1909) pp. 1156-60 (2 figs.).

§ See this Journal, 1909, p. 675-6.

|| *Iron and Steel Inst., Carnegie Scholarship Memoirs*, i. (1909) pp. 219-29 (3 figs.).

PROCEEDINGS OF THE SOCIETY.

MEETING

HELD ON THE 15TH OF DECEMBER, 1909, AT 20 HANOVER SQUARE, W.,
E. J. SPITTA, ESQ., L.R.C.P., ETC., VICE-PRESIDENT, IN THE CHAIR.

The Minutes of the Meeting of November 17, 1909, were read and confirmed, and were signed by the Chairman.

The List of Donations (exclusive of exchanges and reprints) received since the last Meeting, was read as follows, and the thanks of the Society were voted to the donors :—

Acta Societas Scientiarum Fennicæ, xxxvi. No. 4, "Zur Morphologie der Acariden," by Enzo Reuter	From
Ditto, xxxvii. No. 7, "Merokinesis," by Enzo Reuter. (4to, Helsingfors, 1909)	<i>The Author.</i>
William Spiers, Nature through the Microscope. (8vo, London, 1909)	<i>The Author.</i>

Attention was called to some enlargements of photomicrographs of the antennæ and falces of a female spider exhibited by Mr. H. S. Cheavin ; to some specimens of the rarer Foraminifera from Selsey Bill, exhibited under a Microscope by Mr. E. Heron-Allen ; and to some photomicrographs of arranged diatoms, etc., from Mr. M. J. Allan, of Geelong.

The Chairman said : One of the most painful tasks that falls to the lot of a Chairman of any Society is having to refer to the death of any of its Fellows. In some instances, however, this task is at the same time one of great difficulty, such being especially the case when touching the death of a man of such great notoriety and distinction as possessed by the late Dr. Dallinger. Born in 1840, he entered the Society in 1871, and was for many years one of its most prominent Fellows, attaining to the Chair in 1884, a position he occupied for four years. Of late, however, we have not often seen him here, in consequence, I fear, of the weight of increasing years and loss of that vigorous health with which he used apparently to be blessed ; consequently, many present here to-night only know of him by reputation rather than by any personal knowledge. He was a man of undoubted power, having the charm of drawing unusually large audiences. This arose, I think, not only from his quiet manner and vigorous method of speech, but also from the value of what he had to say, which was always enriched by his great personality. I do not propose—for time forbids—to give you any details of his remarkable life, of his researches with Dr. Drysdale, or of his numerous papers devoted to our science, for all of these subjects are related in a far better manner than I could hope to do in an article from the pen of our Secretary in the December issue of the Journal ; but I must refer before sitting down to a request of the Council that I should bring this mournful subject before your notice

so that your wishes could be obtained as to whether you would not like to offer some expression of sympathy with the relatives of Dr. Dallinger, seeing he has had such a lengthy and illustrious connection with our Society. The Council have already passed a resolution to this effect, but I repeat it has been thought you might very possibly desire—nay, even more, would very likely have considered it an omission on their part had they not offered you the opportunity of joining in the same. Is it then your pleasure, gentlemen, that the Secretary be requested to write a suitable letter of condolence to the family, expressing your sympathy with them in their bereavement, and assuring them at the same time of the loss you feel the Society has sustained by the death of so illustrious a Fellow?

The motion for a vote of sympathy with the family of the late Dr. Dallinger was then put to the Meeting, and carried unanimously.

Mr. A. A. C. E. Merlin's paper "On the Measurement of Grayson's 10 Band Plate," was read to the Meeting by Mr. F. S. Scales.

Mr. Rheinberg said the high degree of accuracy attained in the rulings of these lines was sufficiently marvellous, and although it might sound curious to say so, he considered it a positive advantage that an absolute accuracy could not be attained, as in the use of these gratings both for testing the resolving powers of objectives and for diffraction experiments the appearances resulting from the slight deviations from absolute accuracy were particularly helpful to forming one's conclusions.

Mr. Shillington Scales said he did not quite see how Mr. Merlin managed to make measurements of such small degree, because the ordinary micrometer wire was considerably coarser than some of the measurements given, even with the highest magnifications, and would in such minute divisions more than cover the object it was wished to measure. He had met with this difficulty himself in making measurements of less than 0.25μ , and should like to understand how it was got over.

Mr. A. E. Conrady said there would, no doubt, be a considerable difficulty in obtaining the measurements of a very minute single object, but Mr. Merlin worked upon several objects, and in that case it was possible to estimate distances very accurately when a line came between two or three other lines, and the accuracy with which measurements could then be made was quite astonishing. This would be very possible in the case of one-third of a micron, or one-thousandth of a millimetre; but when one spoke of two-millionths of an inch, it looked like a subject for discount.

The Chairman said it would be, he thought, a good institution if when a new Fellow joined the Society his friends should introduce him to the Secretaries and to other prominent members present, so that he should rapidly become acquainted with them all. He mentioned this because it had been brought before his notice that some new Fellows had complained very naturally they felt dull and strange at the Meetings, which was very foreign, he felt sure, to the wishes of those present. It had also been brought before him to mention that the Sectional Meetings of the Society were held on the first and fourth Wednesday evenings in the month, and that it would be an encourage-

ment if more attended the same, for objects were often exhibited and discussions frequently took place that perhaps might not be suitable at the ordinary Meetings, but were, nevertheless, of great interest to those who studies were in some particular direction.

Dr. Hebb said that he was present at the last Meeting of the Biological section on December 4, when Mr. E. J. Spitta gave a beautiful demonstration of the value of the application of the cinematograph to photomicrography. Various aspects of Pond Life, animal and vegetable, were thrown on the screen and exhibited with remarkable fidelity. The demonstration was given at Mr. Banfield's studio, and it was his skill and knowledge of the cinematograph which made the demonstration a complete success. He therefore proposed a special vote of thanks to Mr. Banfield for his courtesy and kindness.

The Chairman said he felt greatly indebted to Mr. Banfield for his kind assistance, for without his very great kindness, he, the Chairman, would have not been able to have shown the section his films.

The Chairman added that he had been requested to announce that the next Meeting of the "Brass and Glass" section would be held on January 26, when the subject of low-power illumination was to be dealt with.

Dr. Marshall Ewell's paper "On a Convenient Form of Stand for Use as a Micro-colorimeter and with Micro-spectroscope," was read by Dr. Hebb, diagrams in illustration being shown upon the board.

The thanks of the Meeting were voted to Dr. Marshall Ewell for his communication.

Dr. James F. Gemmill's paper on "An Automatic Aerating Apparatus for Aquaria," was also read by Dr. Hebb, the drawings referred to in explanation being reproduced upon the board.

The Chairman said that it was always somewhat difficult to thoroughly grasp at the moment descriptions of new apparatus, especially when of a somewhat complicated kind, but the design of the author was very ingenious, and deserving, undoubtedly, of their best thanks: he felt sure those present would desire to return their thanks to the author for his communication.

Mr. F. Enock then gave a lecture "On the Life-history of the Hessian Fly, with Notes on the Tenby Wheat Midge," the subject being illustrated by a number of beautiful coloured lantern slides, showing the various stages from the egg to the perfect insect, and the effect of the ravages of the larva upon the stems of the affected corn. Although known in America as far back as 1776, and believed to have been introduced there in the straw mattresses of some Hessian troops, it was not until 1886 that public attention was called to it in this country. The fallacies then circulated were described and corrected, and the true life-history, as traced by the lecturer, was given. Some notes on observations on the Tenby Wheat Midge, *Climodiplosis equestris*, followed, and were illustrated by lantern slides, and by the exhibition of a living larva under the Microscope.

The Chairman, in moving a vote of thanks to Mr. Enock for his interesting lecture, said that to hear or read about the results of observations of this kind was one thing, but it was quite another to carry out the necessary research. This involved much time and patience. A friend of his once told him that the whole of a four years' research only occupied half a sheet of paper. Now Mr. Enock's half-hour lecture represented observations of a most lengthy kind; such, indeed, might easily have taken him several weeks of very close observation; and he felt sure those present would like to offer Mr. Enock their hearty congratulation both as to the final results obtained, as well as for the intellectual summary he had just given them.

Dr. Hebb reminded the Fellows that the next Meeting would be the Annual Meeting, when the President would give his Address. He then read the list of Officers nominated by the Council for Election for the approaching session:—

President—Professor J. A. Thomson, M.A., F.R.S.E.

Vice-Presidents—Messrs. Cheshire, Disney, Eyre, and Spitta.

Treasurer—Mr. W. E. Baxter.

Secretaries—Dr. Hebb and Mr. F. Shillington Scales.

Ordinary Members of Council—Messrs. F. W. Watson Baker, Barnard, Heron-Allen, C. F. Hill, Hopkinson, Plimmer, Powell, Radley, Rheinberg, Rousselet, Scourfield, and Wesché.

Librarian—Percy E. Radley.

Curator of Instruments, etc.—Charles F. Rousselet.

Curator of Slides—F. Shillington Scales.

Auditor on behalf of the Council—D. J. Scourfield.

The Fellows present were then asked to nominate an auditor to act on their behalf at the annual audit. Mr. C. L. Curties, having been proposed by Mr. Soar and seconded by Mr. Taverner, was unanimously elected as auditor to represent the Fellows.

Dr. Hebb, after alluding to the Special Meeting in June last at which it was agreed to admit Women Fellows to the Meeting, gave notice of the following alterations in By-laws 4 and 27 (viz. omission of the words male and males). These alterations would have the effect of conferring the full privileges of the Society on Women Fellows.

It was intimated that the rooms of the Society would be closed from December 24 to January 3.

The following Instruments, Objects, etc., were exhibited:—

Dr. Hebb:—Three enlargements of Photomicrographs of Parts of Leg, Mouth-organs and Antenna of female Spider, sent for exhibition by Mr. Harold S. Cheavin; and Photomicrographs of arranged Diatoms, etc., from Mr. M. J. Allan, of Geelong.

Mr. E. Heron-Allen:—Slides of the rarer Foraminifera from Selsey Bill.
Mr. F. Enock:—Lantern Slides and living Larva of *Clinodiplosis equestris*, in illustration of his lecture.

New Fellow.—Mr. Walter Bagshaw was balloted for and duly elected a Fellow of the Society.

ANNIVERSARY MEETING

HELD ON THE 19TH OF JANUARY, 1910, AT 20 HANOVER SQUARE, W.
SIR EDWIN RAY LANKESTER, F.R.S., ETC., PRESIDENT, IN THE CHAIR.

The Minutes of the Meeting of December 15, 1909, were read and confirmed, and were signed by the President.

Messrs. H. Taverner and C. D. Soar were duly elected as Scrutineers of the Ballot for the election of Officers and Council of the Society for the ensuing year.

The List of Donations, exclusive of exchanges and reprints, received since the last Meeting, was read, and the thanks of the Society were voted to the donors.

Attention was called by Mr. F. Shillington Scales to a projection lantern, presented by Mr. J. W. Ogilvy, provided with a self-regulating arc lamp of 3000 candle power, and having a neat and convenient arrangement for taking any size slide. As it could be coupled on to the electric supply of that room, it was likely to be of much service to the Society, and was not only a very welcome donation, but one for which they felt greatly indebted to the donor.

On the Motion of the President the special thanks of the Society were voted to Mr. Ogilvy for his valuable addition to their apparatus.

Mr. C. F. Rousselet said he was exhibiting under a Microscope in the room some specimens of a rare species of *Pedalion*, *P. oxyure* Sernow, which he had found in material collected by Dr. Cunningham and C. Boulenger in the brackish lake Birket Qarun, in the Fayûm Province of Egypt. It would be remembered that the first species of this genus, remarkable amongst all other Rotifera, for the possession of six arthropodous limbs, *P. mirum*, was discovered in 1871 by Dr. C. T. Hudson, at Clifton, near Bristol. A second species, *P. fennicum*, was found by Dr. Levander, in Finland, in 1892, and the third species, *P. oxyure*, now exhibited, was found by S. Sernow in 1903 in the Aral Sea. This same species was also found last year by Professor von Daday in material collected in Turkestan, and named by him *P. mucronatum*, which name, therefore, is a synonym, and cannot stand. *P. oxyure* most nearly resembles *P. fennicum*, but differs from it in the fact that the posterior end of the body is drawn out into an elongated hyaline projection.

The President said it was extremely interesting to hear of this find, and hoped they would hear more of it, his opinion being that *Pedalion* was the most wonderful of all the Rotifers, as having legs and striated muscles to work them, and hairs on them resembling those of Crustacea.

Thanks were voted to Mr. Rousselet for bringing this specimen for exhibition.

The President called attention to an exhibition of sections of eyes, exhibited by Mr. F. W. Watson Baker under a number of Microscopes lent for the occasion by Messrs. Watson and Sons.

The thanks of the Society were unanimously voted to Mr. Baker for this very excellent exhibition, and to Messrs. Watson and Sons for the loan of the instruments.

The Report of the Council for the year 1909 was then read by Mr. F. Shillington Scales.

REPORT OF THE COUNCIL FOR 1909.

FELLOWS.

Ordinary.—During the year 1909, 28 new Fellows have been elected, and 3 have been reinstated, whilst 9 have died, 13 have resigned, 3 have been removed, and 2 elections have been declared void.

Five of the deceased were Fellows for periods of from 38 to 58 years, and among them is found the name of Rev. W. H. Dallinger, of whom an obituary notice, with portrait, was given in the December number of the Journal.

Honorary.—The Council regrets to have to announce the deaths of three Honorary Fellows :—Dr. J. Brun, Dr. Anton Dohrn, and Dr. Henri van Heurck.

The number of Honorary Fellows is reduced by the above losses to 40.

The list of Fellows now contains the names of 382 Ordinary, 1 Corresponding, 40 Honorary, and 79 Ex-officio Fellows, being a total of 502.

FINANCE.

The greater activity displayed by the Society this year has necessarily been accompanied with some increased expenditure, but it has also produced an accession of income. Both admission fees and subscriptions are larger than for some few years. The expenditure, however, is still slightly in excess of income, but it is hoped that, as a result of the greater interest shown in the Society's work, the number of Members elected will continue to increase.

JOURNAL.

The Journal for 1909 compares favourably with any of its predecessors. Sixteen important papers are recorded in the Transactions. Some of these papers are very freely illustrated.

It is gratifying to be able to announce that there has been a great increase of the sale of the Journal during the past year.

The Council takes the opportunity of expressing its thanks to the editorial staff for the continued excellence of their work in connection with the summary of current researches relating to Zoology, Botany, Microscopy, and Metallography.

LIBRARY.

The Library has been maintained in good order, and has been enriched during the past year by a most valuable donation from Dr. Braithwaite of a large number of interesting papers on Mosses, bound in twelve volumes. The Society has also received a number of other works, the titles of which have been recorded from time to time in the Journal.

In response to an appeal for funds to print a Catalogue of the Library, a large amount of support has been given; the Catalogue, which has been carefully prepared by Mr. P. E. Radley, and the cost of which was largely defrayed by the generosity of 114 Fellows, is now completed and ready for distribution to the subscribers.

INSTRUMENTS AND APPARATUS.

The Instruments and Apparatus in the Society's Collection continue to be in good condition.

During the past twelve months the following additions have been made:—

- Jan. 20.—A Reflecting Microscope, by Amici. Presented by Mr. S. R. Roget.
- Feb. 17.—A Wilson Screw-barrel Single Pocket Microscope, made by E. Culpeper.
- „ A Small Wilson Screw-barrel Single Pocket Microscope, made by George Sterrop.
- „ A Single Pocket Microscope, made by Banks.
- „ A Lieberkühn "Transparent Solar Microscope," made by Dollond. All presented by Mr. E. Heron-Allen.
- Mar. 17.—A New $\frac{1}{2}$ -in. Oil-immersion Objective. Presented by the maker, Mr. E. Leitz.
- April 21.—A Large Binoocular Microscope, with accessories, made by Ross in 1888, and 3 Apochromatic Objectives and Compensating Eye-pieces, by Carl Zeiss. Presented by Lord Edward Spencer Churchill.
- May 19.—A Microscope Lamp, by Ross. Presented by Lord Edward Spencer Churchill.
- June 16.—An Old Microscope, by George Adams. Presented by Members of the Council.
- Oct. 20.—Two Electric Speculum Lamps, of his own design. Presented by Mr. J. W. Gordon.

CABINET.

The following slides have been added to the Cabinet during the past year: Six slides of Foraminifera from the Adriatic, mounted on the points of needles, so that the specimens can be rotated, presented on February 17 by Mr. Ernest Heath, F.R.M.S.; 77 slides of Foraminifera, from the collection of the late Wm. Kitchen Parker, presented on October 20 by Mr. Ernest Heath, F.R.M.S.; a slide of the very rare diatom, *Aulacodiscus superbus*,* presented by Mr. J. T. Norman Thomas.

* See this Journal, 1909, pp. 793-4.

At a *Conversazione* held in connection with the Seventh International Congress of Applied Chemistry, on June 1, at the Natural History Museum, the Society exhibited a collection of Metallurgical Microscopes and accessory apparatus, together with a set of Metallographic Photographs and Specimens. Considerable interest was manifested in the display, and the success attained was not inadequate to the effort made. The exhibition of instruments, photographs, and specimens was highly appreciated by the assembled chemists—not only for its unprecedented novelty, but also for the excellence of the collection.

The Biological (with which the Bacteriological is now combined) and the Brass and Glass Sectional Meetings have been well attended, and they promise to become an important feature of the Society. For the success of these supplementary Meetings the Society is indebted to the continued efforts and interest of Mr. D. J. Scourfield and Mr. F. Cheshire, the Sectional Secretaries.

In December 1908, a Special Meeting was held, at which the question of granting to women Fellows equal rights with men was debated. As a result of this debate a Special Committee was appointed to deal with the matter. After much labour and correspondence the Committee brought up a Report, to which a minority Report was attached, at a Special Meeting in June. At this Meeting it was resolved that the By-laws be altered so that women Fellows should be admitted to the Meetings. The Council, however, are of opinion that it is advisable to alter the By-laws so as to give equal rights to women Fellows, and suggest that the By-laws be altered in this sense. To give effect to this it is merely necessary to omit the references to males in By-laws 4 and 27.

It is hoped that this alteration will have the effect of allaying a long-standing grievance and of increasing the number of Fellows.

The Treasurer's Report and Balance Sheet for the year 1909 were read to the Meeting by Mr. W. E. Baxter.

On the motion of the President, the Report and Balance Sheet were unanimously adopted.

The Report of the Scrutineers was then handed in, and the following Fellows were declared to have been duly elected as Officers and Council of the Society for the ensuing year:—

President—J. Arthur Thomson, M.A. F.R.S.E., Regius Professor of Natural History in the University of Aberdeen.

Vice-Presidents—Frederic J. Cheshire; A. N. Disney, M.A. B.Sc.; J. W. H. Eyre, M.D. F.R.S. (Edin.); E. J. Spitta, L.R.C.P. (Lond.) M.R.C.S. (Eng.)

Treasurer—Wynne E. Baxter, J.P., F.G.S. F.R.G.S.

Secretaries—R. G. Hebb, M.A. M.D. F.R.C.P.; F. Shillington Scales, M.A. M.B. B.C. (Cantab.).

CASH STATEMENT FOR THE YEAR ENDING 31ST DEC. 1909.

	£	s.	d.	Cr.
To Balance from 1908	2	6	0	146 0 6
" Admission Fees	52	10	0	165 14 0
" Annual Subscriptions—				125 5 11
1905	£4	4	0	15 17 5
1906	8	6	0	
1907	28	5	0	
1908	57	16	6	
1909	548	5	9	
1910	23	14	3	
1911	2	12	6	
1912, etc.	9	9	0	
Interest on Investments	682	13	0	648 5 7
" Sale of Journals	61	15	1	27 11 3
" Advertisements	340	10	5	13 10 0
" Sale of Surplus Books	60	0	0	23 1 1
" Reprints and List of Fellows	7	7	0	3 5 0
" Income Tax returned, etc.	14	5	6	47 17 9
" Sale of Tools	4	19	8	2 7 3
" Donations to Library Catalogue	0	4	0	2 10 6
" Deposit	48	10	6	150 0 0
	150	0	0	53 14 11
				£1425 1 2
By Rent, Coals, etc.			
" Salaries and Reporting			
" Books and Periodicals purchased			
" Bookbinding			
" Expenses of Journal—			
Editing				£152 13 3
Illustrations				73 8 1
Printing and Postage				422 4 3
Purchase of 30l. Metropolitan Water Board			
" Refreshments at Meetings			
" Stationery			
" Fire Insurance			
" Postage and Petty Disbursements			
" Rent of Stock of Journals			
" Repairs			
" Deposit Withdrawn			
" Balance to 1910			
				£1425 1 2

Investments.

	£	s.	d.
North British Railway	400	0	0
Nottingham Corporation Stock Three per Cents.	400	0	0
New South Wales Three and a Half per Cents.	400	0	0
India Three per Cents.	700	0	0
Metropolitan Water Board B Stock	150	0	0
	£2050	0	0

WYNNE E. BAXTER, Treasurer.

We have examined the foregoing Account, and compared the same with the Vouchers in the possession of the Society; we have also verified its Securities as above mentioned, and find the same correct.

D. J. SCOURFIELD }
C. LEES CURTIES } Auditors.

January 11, 1910.

Ordinary Members of Council—F. W. Watson Baker ; J. E. Barnard ; Edward Heron-Allen, F.L.S. F.Z.S. F.R.Met.S. ; C. F. Hill ; John Hopkinson ; Henry Geo. Plimmer, F.L.S. ; Thomas H. Powell ; P. E. Radley ; Julius Rheinberg ; Charles F. Rousselet ; David J. Scourfield ; W. Wesché.

Librarian—Percy E. Radley.

Curator of Instruments, etc.—Charles F. Rousselet.

Curator of Slides—F. Shillington Scales, M.A. M.B. B.C. (Cantab.).

Pursuant to notice given at the previous Meeting, the following alterations in the By-laws were suggested by the Council, to meet the resolution carried at the Meeting of the Society in June :—

Rule 4.—To omit the words “all being males.”

„ 27.—Line 4, to omit the word “male” ; line 8, to omit the words “being males.”

These alterations having been moved by Mr. Heron-Allen, and seconded by Mr. Hopkinson, were put to the Meeting by the President, and declared to have been carried.

The President then gave the Annual Address, in the course of which he congratulated the Society upon its increased prosperity, and, after making appreciative reference to the work of the late Dr. Dallinger, he referred to such work as he thought could be carried out by the Fellows with reference to the action of light upon protoplasm, the differentiation and specific effects of α -, β -, and γ -rays emanating from radium, and the part actually played by bacteria in the processes of digestion. Medical science wanted their assistance in these investigations, which he thought could be, in some directions, better followed up by Naturalists than by Physiologists. Attention was also called to an organism (*Clathrocystis æruginosa*) found by Henfrey in 1852, in a pond in Kew Gardens, and so named by him, as worthy of their attention. He regretted that he had been unable to attend more of their Meetings, but assured them that he took great interest in the work of the Society.

Mr. A. D. Michael said he rose to move that the best thanks of the Society be given to the President for his Address, and to request that he would allow it to be printed and circulated in the usual way. He need not say that the address was one of very high interest, because the President was not in the habit of writing or delivering addresses that were not so ; but this address was not only one of great scientific interest, but also of great practical value, opening up a vast field of research, particularly to the Fellows of their own Society. It was an address which, when printed, would enrich the pages of the Journal.

Mr. Wynne E. Baxter said he had great pleasure in seconding the vote of thanks to the President for his address, which had been of great interest to them all, and he thought it a great honour that their President should have been with them that evening, on the fiftieth anniversary of the day when, as President of the Society, his father had delivered the annual address. He had not only given them a most useful and

interesting address, but he had given them a good year's work to do if they carried out all his suggestions. They were extremely obliged to him for coming amongst them that evening.

The motion having been put to the Meeting, was carried unanimously, with acclamation.

The President thanked the Fellows of the Society for the way they had received his address, and also the mover and seconder of the vote of thanks for their kind references to it. He hoped that some of the suggestions made would bear fruit, many of them it would be quite possible to carry out, and should be taken up.

Mr. Maurice Blood moved that the best thanks of the Society be given to the Honorary Officers of the Society for their services during the past year. They had carried on the business of the Society so smoothly that their work was likely to be overlooked, and perhaps it would be possible to appreciate their services better if things went wrong sometimes. Though their officers were all very busy men, as everybody knew, yet they were willing to give their time and services to the efficient working of the Society, which still further entitled them to the gratitude of the Fellows.

Mr. George Tilling said that he seconded this motion with very great pleasure, for they knew not only that their officers must have given a great amount of time to the business of the Society, but they as Fellows, had evidence of the quality of the work done. They knew also that their Secretary, Dr. Hebb, had been especially active in the interests of the Society, and he could not recall one instance previously in which he had been absent from their Meetings. It would be invidious, however, to mention the work of individuals where every Honorary Officer had done so much.

The motion, on being put to the Meeting by the President, was carried unanimously.

Mr. F. Shillington Scales said it fell to him this time to acknowledge this vote of thanks on behalf of the Officers and Council. The last year had been an unusually anxious one to them on account of the special matters which they had to consider. There was the matter of the lease referred to in the Report, and the question of finance had occupied attention, though he was glad to say that this was the first time for some years in which they had been able to report a distinct improvement in their financial position. The idea of the new Library Catalogue had originated with one of the Fellows who was not on the Council, and who had offered a contribution towards the cost, and the rest of the money had been raised by subscription. This catalogue of the books in the library would very shortly be ready for issue. It had entailed a great deal of labour, for all of which they were greatly indebted to their Honorary Librarian. Another anxious matter had been the question of the admission of women Fellows to the full privileges of the Society, now an accomplished fact. Though somewhat outside his province, he might, perhaps, be allowed to point out the advantage to the Society of having a man of such scientific eminence as Sir Ray Lankester as its head. They also had elected many new Fellows. He greatly

regretted the absence of Dr. Hebb that evening, to whom, as Secretary, the Society was greatly indebted; for eleven years past he had given them his services, had come to them not seldom at great personal inconvenience, and he believed this was the first time Dr. Hebb had been absent during the whole of that time.

A vote of thanks to the Auditors and Scrutineers was then moved by Mr. Marshall, seconded by Mr. Freshwater, and unanimously carried.

Mr. Heron-Allen said he rose to propose that a very cordial vote of thanks be given to their Librarian, Mr. Radley, for the skill, labour, and enthusiasm which he had put into the work of preparing the new catalogue. The Society had known for many years that they had a great treasure packed away upon their crowded shelves, but were in the position of a man who knew he had a mine of wealth under his estate, but had no one to whom he could entrust the work of developing it. Such a person had arisen in their midst in the person of Mr. Radley, who had undertaken to make the catalogue, and had now completed the task with conspicuous ability and consequent success. They probably knew something of what heart-breaking work it was to compile a catalogue of books, and the invisible labour involved in the process, and he felt sure that all the Fellows of the Society would join in according to Mr. Radley the vote of thanks which he had proposed.

Mr. W. Wesché, having seconded the motion, it was put to the Meeting by the President, and carried unanimously.

The following Instrument, Objects, etc., were exhibited:—

The Society:—Projection Lantern, with self-regulating arc-light, presented by Mr. J. W. Ogilvy.

Mr. C. F. Rousselet:—Mounted specimen of *Pedalion oxyure* Sernow, from Egypt.

Mr. F. W. Watson Baker:—Microscope Slides, illustrating the structure and development of the eye:—1. Section through embryo Rat, showing the eyes. 2. Ditto, head of foetal Mouse, showing eyes. 3. Ditto, head of foetal Guinea-pig, showing eyes. 4. Section of eye of Snail. 5. Ditto, *Ditiscus*. 6. Ditto, Dragon-fly. 7. Eyes of garden Spider (*Epeira*). 8. Section of eye of Cray-fish. 9. Ditto, head and eyes of Pipe-fish. 10. Ditto, ditto, Goby. 11. Ditto, eye of Dog-fish. 12. Ditto, head and eyes of Squid. 13. Ditto, eye of Frog. 14. Ditto, eye of Pigeon, showing pecten. 15. Ditto, human retina through fovea centralis. 16. Meibomian glands in human eye-lid.

New Fellows:—The following were elected *Ordinary* Fellows of the Society:—Messrs. F. C. Dumat, Frederick Leonard McKeever, Alfred William Sheppard, Sir Almroth Edward Wright.

JOURNAL
OF THE
ROYAL MICROSCOPICAL SOCIETY.

APRIL, 1910.

TRANSACTIONS OF THE SOCIETY.

IV.—*The President's Address.*

By SIR E. RAY LANKESTER.

(*Read January 19, 1910.*)

At the close of my year of office, I desire to congratulate the Society on its prosperity, on the increased number of its Fellows, and on the settlement of the question as to the rights of women in regard to the Society. We have lost one very distinguished Fellow, a former President, for whose work I have always felt the greatest respect and interest—the Rev. W. H. Dallinger. Full details of his life and work have been given in the Journal of the Society. I would only add to what is there said, that I consider his work to have been typical of that fine and original investigation which we get from the real lover of microscopic biology, the true amateur, the true dilettante—he who works because he loves the subject, and not because it is a profession, or connected with business and advancement. Such absolutely original observation and views as we owe to Dallinger cannot come from the academic laboratory—they are born in the private study and workshop. The Society has from time to time had such original and independent workers amongst its leading Fellows, and it needs their presence and assistance more than that of any other type of man.

The Society has received some valuable communications during the year, but they have not been so varied nor so numerous as might be expected. There are many subjects upon which microscopical examination throws a flood of light, which are not part of the regular work of the colleges and schools: there are the old traditional fields of delight in which the Fellows of the Society are famous—the pond-life of minutest animals and plants. I could have wished to give you some account of what has been going on

April 20th, 1910

L

in some of these regions of discovery, but, unfortunately, my time and my strength are both limited and greatly taxed at present. I must content myself by alluding to one or two matters which have come under my notice of late, and seem to me to demand the attention and work of the Fellows of this Society, to whom, indeed, such inquiries are especially appropriate.

There is, in the first place, the whole question of what is called the ultra-microscope. We may distinguish between indefinite vision and definite vision. It has always been the object of the microscopist to obtain definition: a picture with sharp presentation of outline and shape corresponding to a natural reality. The ultra-microscopist abandons this aim; it is enough for him if he can obtain evidence, by speck-like vague obstruction of light, that something capable of interrupting the path of a light-ray is present. And when our aim is limited to the recognition of the existence of such vague undefined particles, we have to extend very greatly the limits of the size of the "ultimum visibile," as compared with the limit assigned when something like an outline and the discrimination of shape is understood by the word "visible." Remarkable results as to the existence of particles indefinitely (by no means definitely) visible have been obtained by using special modes of illumination. The ordinary horizontal illumination, which we used to call "dark-ground illumination," has been lately brought into use in Paris and elsewhere in the study of living microbes and blood—with some success—and the name "ultra-microscopy" has been applied to some of the results, such as brilliant illumination of granules otherwise invisible. The most interesting application of this horizontal illumination has been to the production of cinematographic films, showing actively moving spirilla driving their way corkscrew-like through the blood, whilst the slower movements of phagocytes are also recorded. The great difficulty in producing such films arises from the fact that the intense illumination necessary for rapid photography of the moving object is paralysing and destructive to living naked protoplasm. It is more rapidly fatal to amoeboid protoplasm than to the flagella of spirilla and bacteria, but acts fatally upon both; the former can rarely be photographed in movement, the latter always remain active for a sufficient time. The films made in Paris will, I believe, soon be exhibited in London, being in the hands of the great entrepreneur of cinematography, Pathé et Cie., at whose works the experimental films were made. I hope very much that some of our own Fellows may take up this interesting but difficult practical problem, and I believe that Dr. Spitta has already achieved satisfactory results, though I have not been able to see them for myself.

It is interesting in connection with this question of bacteria and light to note that an interesting contribution to our knowledge of this subject has lately been made by Sir James Dewar.

Sir James was desirous of studying the action of intense cold (a few degrees above the absolute zero, which corresponds to $-273^{\circ}\text{C}.$) upon the simplest living matter. He found a convenient *corpus vile*, or experimental organism, in the bacteria which cause phosphorescence of stale fish, etc. He found that he could freeze cultivations of these bacteria, when their luminosity would cease and all evidence of "life" disappear, but that on raising the temperature, even after an interval of weeks, the bacteria immediately became luminous—giving thus a ready test of their return to the active phase of life, and a proof that they had survived the temperature to which they were exposed. He found that phosphorescent bacteria survived an exposure of many weeks to a temperature approaching the absolute zero. In that frozen condition nothing could attack them or injure them; so long as the low temperature was maintained they were in a state of "arrested movement"—a true suspended animation—like a watch the movement of which is restrained by a needle. When the needle, or the low temperature, is removed, the apparatus works as before. But Sir James Dewar found that there is one agent which can affect the bacteria even when they are frozen hard at the temperature of liquid hydrogen. That is radiant energy of that wave-length which we call violet and ultra-violet. The rays of the blue end of the spectrum destroy the bacteria even when frozen—as he showed by a simple experiment. Kept in the dark or shade, the frozen bacteria survive and become phosphorescent once again on thawing, but if exposed to direct sunlight, or to the blue end of the electric arc, they are killed.

It seems to me that there is a splendid field here for further work by some of our Fellows. It was long ago shown that direct sunlight inhibits and then kills ordinary putrefactive bacteria. The more precise study of the action of light-rays on protoplasm of various kinds is open to further investigation, as well as the discovery of the various means by which the protoplasm of both the lowest and highest animals is protected from the destructive action of light.

And this brings me to one of the questions of the day, namely, the action of the α , β , and γ rays of radium upon protoplasm in its different conditions of nakedness and protection. We shall not get to a real understanding of the possible use of radium-rays as a curative agent until the action of each group, the α , β , and γ , has been studied experimentally in the most simple cases, so as to determine in what way these rays, each apart from the other, affects the elaborate proteid molecules and the ultimate hidden highest combination, concealed in that slimy structure which we call protoplasm.

I hope that some work on this subject may be undertaken by Fellows of the Society. It is of no use for the purpose of really

getting far in the matter to roughly apply a bulb holding radium salt to this or that tissue of plant or animal. More delicate methods of experiment must be devised, and the simplest microscopic organisms will probably be found to lend themselves to the inquiry.

Let me now pass to another question concerning bacteria, one which we as naturalists and biologists might pursue on lines somewhat distinct from those necessarily used by the medical man.

The part played by bacteria in the alimentary canal of man has become a very important matter of investigation. It is now attempted to check the activity of putrefactive bacteria which require alkaline conditions for their activity, by introducing with the food (as suggested by Metchnikoff) acid-producing bacteria, those which produce lactic acid. Such lactic-acid-producing bacteria are taken in sour milk, and it has been certainly ascertained that they do for a time establish themselves in the large intestine and produce there an acid environment, which checks the growth of certain putrefactive micro-organisms. The whole subject of the microbial flora of the alimentary canal is under investigation and demands an immense amount of further observation and experiment. The condition of the alimentary canal of lower animals in regard to bacterial activity is of great interest. It has been held by some writers that the activity of bacteria is absolutely necessary for the proper accomplishment of the digestive process in animals. Metchnikoff has, however, shown that the large fruit bats (*Pteropus*) of the East Indies have the digestive tract practically free from bacteria, and that certainly bacteria do not take part in the breaking up of food in that creature's intestine. The same fact has been shown in regard to the digestion of some insects—experiments having been made in which newly hatched larvæ were fed upon food devoid of bacterial germs. The subject, in so far as it is one which is elucidated by the study of the smaller forms of animal life, is one which is admirably suited to the efforts of the microscopist who works in his own study with simple apparatus. A complete study of the bacteria to be found in the alimentary tract of all animals, with a demonstration of the history and source and activity of such bacteria as are found, is required. Even amongst the Protozoa we find intrusive "bacteria" taking part in the life-processes of their hosts as a normal thing. The "rodlets" described by Greef in his original account of the amœboid *Pelomyxa*—as a constituent part of the organism—are very abundant and were regarded as crystalline needles. They were, however, not present in a new species of *Pelomyxa* discovered by Professor Bourne in Madras, although invariably found in the European *Pelomyxa palustris*. Fourteen years ago these rodlets were shown in my laboratory at Oxford to be bacteria, and were cultivated by Mr. Hill, now of Eton College. Among the Ciliata, bacteria occur in a more excep-

tional way, though they are so frequent in a species of *Paramoecium* as to have been formerly mistaken for spermatozoa. The relations of bacteria to sponges, to hydroid polyps and sea-anemones, cannot fail to yield valuable results when studied, and those occurring in the gut of Annelids and Molluscs, when the digestive secretions are also studied, must give new insight into the whole subject. In the great *Sipunculus nudus*, common at Naples, I found years ago that the remarkable little caecum placed near the rectum is not unfrequently distended and filled with a cream-like mass of delicate bacilli.

Lastly, I would venture to mention to the Society an extremely interesting organism connected with the Bacteria—one of the Cyanophyceæ—which exists at our doors in London, namely in the "museum-lake" at Kew Gardens, where it was originally discovered fifty-five years ago by Henfrey, who gave to it the name *Clathrocystis æruginosa*. In masses it has a strong apple-green tint, which on drying turns to a verdigris blue if exposed to sunlight, but not if kept in the dark. It is associated with *Amphanizomenon* and *Anabaena*, and there is much to suggest that it is a "glæococcus" phase of one of those genera. It has a special interest for me as resembling some of the peach-red coloured bacterial growths which I described many years ago as *Bacterium rubescens*. Professor Ferdinand Cohn, of Breslau, considered the "glæococcus" phase of that rubescent organism to be referable to Henfrey's genus, and called it *Clathrocystis roseo-persicina*. I have again this year made some study of Henfrey's *C. æruginosa*, especially as to the existence of nucleus or nuclear matter, but I have not now proper opportunity for its investigation. The question of the genetic relation of "glæococcus" forms to the filamentous Bacteria and Cyanophyceæ is well worth the attention of microscopists. I formulated many years ago the view—based on my study of *Bacterium rubescens*—that this is (as also are other but not all Bacteria) a polymorphic species, and that the red *Clathrocystis* is one of its growth-phases, others being long filaments, very large bacterial forms, remarkable disks, and also rod-like growths and *Hydrodictyon*-like networks. Zopf subsequently advocated the same view and gave illustrations of polymorphic phases, not only from my *B. rubescens* (Cohn's *C. roseo-persicina*), but from other forms, such as *Beggiatoa*, which serve to connect the Cyanophyceæ and the Bacteria. But of late years the view seems to have prevailed that our polymorphic growth-phases are distinct species and genera—a conclusion the truth of which I do not think has been made probable, much less established. I should like to see the whole question re-investigated.

V.—Note on *Dendrobrachia fallax* Brook, a Rare and Remarkable Antipatharian.

By PROFESSOR J. ARTHUR THOMSON, M.A.

(Read February 16, 1910.)

IN a collection of Alcyonarians which I received for description from His Serene Highness the Prince of Monaco, there were four specimens of unusual appearance and puzzling character—with a spinose axis and pinnate tentacles—which are undoubtedly referable to a remarkable type of Antipatharian, which Brook described in 1889 under the name *Dendrobrachia fallax*. Although I have not much that is new to add to Brook's excellent description and figures, it may be of interest to record the re-observation of an extraordinary type, which seems to have remained unnoticed for more than twenty years. Very unfortunately, three of the specimens were dry, while the fourth, which was preserved in spirit, had only a few extremely brittle polyps.

What are the peculiarities of the type which give it a somewhat aloof position among Antipatharians?

1. The axis is without a central canal. In its younger parts it consists of about five longitudinal ridges or plates, standing out from a thin central stem and showing a distantly dentate margin. As growth goes on, there seems to be an increase in the number of outstanding ridges, and at the same time, by the deposition of successive concentric layers of horn, the deep troughs between the ridges are filled up, and an approximation to the ordinary type of Antipatharian axis is thus reached. There is great diversity in the size and shape of the spines in different parts of the colony. The colour of the axis varies from yellowish-brown to amber-brown. The basal portion, which was absent in Brook's two specimens, is well seen in two cases.

2. The polyps are even more remarkable than the axis. They arise laterally, often in sub-opposite pairs, but there may be a considerable interval, of two lengths or more, between two pairs. In short, they are much more distant than is usual in Antipatharians. Nor do they, in most cases, stand out at right angles, as Antipatharian polyps usually do; they are often appressed to the twig, or form an acute angle with it. The tentacles are retractile, which is also unusual, so that in some cases there is simply a circle of knobs around the prominent oral cone. Still more striking is the fact that they bear well-developed pinnules, six to seven pairs in the

twelve polyps examined. It was impossible to cut the extremely brittle tissue, and the tentacles split very readily up the middle, but in four or five cases there seemed no doubt as to the presence of eight. Brook was not able to determine the number. In one case it seemed fairly certain that there were eight mesenteries.

The occurrence of eight pinnate tentacles at once suggests an Alcyonarian, and one was reminded that in many cases Alcyonid Alcyonarians grow over the naked axes of Gorgonids so thoroughly that a very deceptive appearance results. There is not, however, anything—such as uncovered tips on the twigs, or hummocking of the coenenchyma—to lead one to suppose that the specimen is not a unity. Moreover, there is no hint of Alcyonarian spicules, and the pinnules on the tentacles are much more irregular than in Alcyonarians. One would not indeed consider this possibility, were it not that some cases of the masking of extrinsic axes by Alcyonarians are almost incredibly deceptive, and were it not that the type in question is such a puzzling Antipatharian.

That Antipatharians have affinities with Zoantharians seems probable, and it is interesting to remember that the primitive type *Edwardsia* has only eight complete mesenteries, that a young *Halcompa* has eight tentacles, and that some sea-anemones, e.g. *Actinodendron*, have irregularly pinnate tentacles. There seems to be little doubt that *Dendrobrachia fallax* is a primitive Antipatharian, nearer than many to the Zoantharian stock. One would like to see more of it.

Brook's two specimens were dredged in 1876 from 425 fathoms off Ascension; those now exhibited were dredged in 1901 from 219 fathoms off the island of St. Vincent, in the Cape Verde Islands.

VI.—*On the Measurement of the First Nine Groups of Grayson's Finest Twelve-band Plate.*

BY A. A. C. ELIOT MERLIN.

(Read February 16, 1910.)

I HAVE recently effected the measurement of the first nine groups of Grayson's finest plate containing twelve bands of rulings, commencing at $\frac{1}{100000}$ in. spaces, and increasing up to $\frac{1}{120000}$ in. So far as I am aware, no attempt has hitherto been made to span such close lines with the screw micrometer wire, and it has consequently been thought that the outcome may prove worthy of record.

The measurements, details of which are contained in the annexed table, were effected by means of a $\frac{1}{2}$ Powell oil-immersion objective of measured N.A. 1.27, a negative amplifying lens, increasing the initial magnification of the objective about two and a half times, and an ordinary Powell screw micrometer furnished with a 6 eye-piece. With this optical combination, 134.5 drum divisions were found to equal $\frac{1}{100000}$ in., thus making a movement of the wire through one division equal to $\frac{1}{13450000}$ in. It is here, perhaps, hardly necessary to remark that in the highly accurate determination of intervals, well within the defining power of a lens, the separating limit does not enter as a factor.

In order to eliminate and indicate the micrometer screw error, and to make evident the true relative accuracy of these beautiful rulings, in addition to the values of the individual line spaces given in the first of the two columns devoted to groups 2, 3, 4, 5, 6, and 7 in the annexed table, which were necessarily effected with varying and sometimes wholly different portions of the screw, a second column exhibits the readings obtained by spanning two spaces throughout the second band, three throughout the third, and so on up to seven throughout the seventh group, utilising for all the spaces the exact portion of the screw used for each of the $\frac{1}{100000}$ in. lines of the first band, so that the means of the five resultant readings, given in these columns, are free from micrometer screw error, and indicate the true value of the various groups in terms of the first.

The first seven bands ($\frac{1}{100000}$ to $\frac{1}{700000}$ in.) were measured under strictly critical conditions with the full axial illuminating cone of Powell's dry apochromatic condenser, affording a working aperture of N.A. 0.95, or thereabouts, used in conjunction with Gifford's F-line screen. For the eighth and ninth bands ($\frac{1}{800000}$

MEASUREMENTS OF FIRST NINE BANDS OF GRAYSON'S FINEST TWELVE-BAND PLATE.

First Band	Second Band	Third Band	Fourth Band	Fifth Band	Sixth Band	Seventh Band	Eighth Band	Ninth Band
1/10000 in.	1/20000 in.	1/30000 in.	1/40000 in.	1/50000 in.	1/60000 in.	1/70000 in.	1/80000 in.	1/90000 in.
133.0	67.1	42.6	34.0	24.6	20.0	16.7	16.6	14.0
132.4	67.0	41.9	33.8	24.7	21.0	25.1	16.5	13.0
135.0	67.0	41.9	33.8	24.7	21.0	17.1	16.5	12.6
135.9	66.2	45.5	32.8	22.9	20.8	17.7	16.5	13.2
135.4	66.0	43.0	32.5	25.2	21.5	17.6	14.9	17.9
134.7	67.4	44.4	35.5	29.5	21.6	19.8	13.7	10.9
134.4	66.0	47.7	32.8	27.4	20.3	19.1	11.8	17.4
135.6	66.9	43.7	32.7	26.8	28.2	20.1	14.8	16.6
134.9	66.5	44.0	36.1	29.5	21.6	17.8	15.6	13.2
133.8	66.8	44.9	33.5	26.6	20.9	18.6	17.4	16.0
		42.4	32.9	26.2	24.0	17.3		
		45.9	32.8	27.3	21.7	21.4		
		47.1	32.4	27.9	21.9	18.7		
		47.2	34.7	24.7	23.1	16.3		
		43.0	34.4	27.8	21.5	21.5		
			33.3	27.2	21.3	20.2		
			32.7	28.8	24.0	16.7		
			34.3	24.8	22.2	18.6		
			35.0	29.2	21.4	20.5		
			32.8	26.0	21.8	21.7		
				24.0	23.8	14.1		
				28.2	19.0	22.1		
				26.4	23.3	19.4		
				26.7	24.1	18.4		
				26.5	20.2	18.0		
					26.2	23.8		
					21.4	17.9		
					20.0	18.2		
					23.5	19.2		
						20.6		
						19.2		
						17.3		
						17.6		
						20.9		
Mean of Readings	133.4	133.2	133.0	133.4	132.9	131.5	132.1	133.5
Mean in 10,000ths	1334	1332	1330	1334	1329	1315	1321	1335
Mean of Readings	138.4	138.2	138.0	138.4	138.7	138.7	138.9	139.1
Mean in 10,000ths	1384	1382	1380	1384	1387	1387	1389	1391
Mean of Readings	143.4	143.2	143.0	143.4	143.7	143.7	143.9	144.1
Mean in 10,000ths	1434	1432	1430	1434	1437	1437	1439	1441
Mean of Readings	148.4	148.2	148.0	148.4	148.7	148.7	148.9	149.1
Mean in 10,000ths	1484	1482	1480	1484	1487	1487	1489	1491
Mean of Readings	153.4	153.2	153.0	153.4	153.7	153.7	153.9	154.1
Mean in 10,000ths	1534	1532	1530	1534	1537	1537	1539	1541
Mean of Readings	158.4	158.2	158.0	158.4	158.7	158.7	158.9	159.1
Mean in 10,000ths	1584	1582	1580	1584	1587	1587	1589	1591
Mean of Readings	163.4	163.2	163.0	163.4	163.7	163.7	163.9	164.1
Mean in 10,000ths	1634	1632	1630	1634	1637	1637	1639	1641
Mean of Readings	168.4	168.2	168.0	168.4	168.7	168.7	168.9	169.1
Mean in 10,000ths	1684	1682	1680	1684	1687	1687	1689	1691
Mean of Readings	173.4	173.2	173.0	173.4	173.7	173.7	173.9	174.1
Mean in 10,000ths	1734	1732	1730	1734	1737	1737	1739	1741
Mean of Readings	178.4	178.2	178.0	178.4	178.7	178.7	178.9	179.1
Mean in 10,000ths	1784	1782	1780	1784	1787	1787	1789	1791
Mean of Readings	183.4	183.2	183.0	183.4	183.7	183.7	183.9	184.1
Mean in 10,000ths	1834	1832	1830	1834	1837	1837	1839	1841
Mean of Readings	188.4	188.2	188.0	188.4	188.7	188.7	188.9	189.1
Mean in 10,000ths	1884	1882	1880	1884	1887	1887	1889	1891
Mean of Readings	193.4	193.2	193.0	193.4	193.7	193.7	193.9	194.1
Mean in 10,000ths	1934	1932	1930	1934	1937	1937	1939	1941
Mean of Readings	198.4	198.2	198.0	198.4	198.7	198.7	198.9	199.1
Mean in 10,000ths	1984	1982	1980	1984	1987	1987	1989	1991
Mean of Readings	203.4	203.2	203.0	203.4	203.7	203.7	203.9	204.1
Mean in 10,000ths	2034	2032	2030	2034	2037	2037	2039	2041
Mean of Readings	208.4	208.2	208.0	208.4	208.7	208.7	208.9	209.1
Mean in 10,000ths	2084	2082	2080	2084	2087	2087	2089	2091
Mean of Readings	213.4	213.2	213.0	213.4	213.7	213.7	213.9	214.1
Mean in 10,000ths	2134	2132	2130	2134	2137	2137	2139	2141
Mean of Readings	218.4	218.2	218.0	218.4	218.7	218.7	218.9	219.1
Mean in 10,000ths	2184	2182	2180	2184	2187	2187	2189	2191
Mean of Readings	223.4	223.2	223.0	223.4	223.7	223.7	223.9	224.1
Mean in 10,000ths	2234	2232	2230	2234	2237	2237	2239	2241
Mean of Readings	228.4	228.2	228.0	228.4	228.7	228.7	228.9	229.1
Mean in 10,000ths	2284	2282	2280	2284	2287	2287	2289	2291
Mean of Readings	233.4	233.2	233.0	233.4	233.7	233.7	233.9	234.1
Mean in 10,000ths	2334	2332	2330	2334	2337	2337	2339	2341
Mean of Readings	238.4	238.2	238.0	238.4	238.7	238.7	238.9	239.1
Mean in 10,000ths	2384	2382	2380	2384	2387	2387	2389	2391
Mean of Readings	243.4	243.2	243.0	243.4	243.7	243.7	243.9	244.1
Mean in 10,000ths	2434	2432	2430	2434	2437	2437	2439	2441
Mean of Readings	248.4	248.2	248.0	248.4	248.7	248.7	248.9	249.1
Mean in 10,000ths	2484	2482	2480	2484	2487	2487	2489	2491
Mean of Readings	253.4	253.2	253.0	253.4	253.7	253.7	253.9	254.1
Mean in 10,000ths	2534	2532	2530	2534	2537	2537	2539	2541
Mean of Readings	258.4	258.2	258.0	258.4	258.7	258.7	258.9	259.1
Mean in 10,000ths	2584	2582	2580	2584	2587	2587	2589	2591
Mean of Readings	263.4	263.2	263.0	263.4	263.7	263.7	263.9	264.1
Mean in 10,000ths	2634	2632	2630	2634	2637	2637	2639	2641
Mean of Readings	268.4	268.2	268.0	268.4	268.7	268.7	268.9	269.1
Mean in 10,000ths	2684	2682	2680	2684	2687	2687	2689	2691
Mean of Readings	273.4	273.2	273.0	273.4	273.7	273.7	273.9	274.1
Mean in 10,000ths	2734	2732	2730	2734	2737	2737	2739	2741
Mean of Readings	278.4	278.2	278.0	278.4	278.7	278.7	278.9	279.1
Mean in 10,000ths	2784	2782	2780	2784	2787	2787	2789	2791
Mean of Readings	283.4	283.2	283.0	283.4	283.7	283.7	283.9	284.1
Mean in 10,000ths	2834	2832	2830	2834	2837	2837	2839	2841
Mean of Readings	288.4	288.2	288.0	288.4	288.7	288.7	288.9	289.1
Mean in 10,000ths	2884	2882	2880	2884	2887	2887	2889	2891
Mean of Readings	293.4	293.2	293.0	293.4	293.7	293.7	293.9	294.1
Mean in 10,000ths	2934	2932	2930	2934	2937	2937	2939	2941
Mean of Readings	298.4	298.2	298.0	298.4	298.7	298.7	298.9	299.1
Mean in 10,000ths	2984	2982	2980	2984	2987	2987	2989	2991
Mean of Readings	303.4	303.2	303.0	303.4	303.7	303.7	303.9	304.1
Mean in 10,000ths	3034	3032	3030	3034	3037	3037	3039	3041
Mean of Readings	308.4	308.2	308.0	308.4	308.7	308.7	308.9	309.1
Mean in 10,000ths	3084	3082	3080	3084	3087	3087	3089	3091
Mean of Readings	313.4	313.2	313.0	313.4	313.7	313.7	313.9	314.1
Mean in 10,000ths	3134	3132	3130	3134	3137	3137	3139	3141
Mean of Readings	318.4	318.2	318.0	318.4	318.7	318.7	318.9	319.1
Mean in 10,000ths	3184	3182	3180	3184	3187	3187	3189	3191
Mean of Readings	323.4	323.2	323.0	323.4	323.7	323.7	323.9	324.1
Mean in 10,000ths	3234	3232	3230	3234	3237	3237	3239	3241
Mean of Readings	328.4	328.2	328.0	328.4	328.7	328.7	328.9	329.1
Mean in 10,000ths	3284	3282	3280	3284	3287	3287	3289	3291
Mean of Readings	333.4	333.2	333.0	333.4	333.7	333.7	333.9	334.1
Mean in 10,000ths	3334	3332	3330	3334	3337	3337	3339	3341
Mean of Readings	338.4	338.2	338.0	338.4	338.7	338.7	338.9	339.1
Mean in 10,000ths	3384	3382	3380	3384	3387	3387	3389	3391
Mean of Readings	343.4	343.2	343.0	343.4	343.7	343.7	343.9	344.1
Mean in 10,000ths	3434	3432	3430	3434	3437	3437	3439	3441
Mean of Readings	348.4	348.2	348.0	348.4	348.7	348.7	348.9	349.1
Mean in 10,000ths	3484	3482	3480	3484	3487	3487	3489	3491
Mean of Readings	353.4	353.2	353.0	353.4	353.7	353.7	35	

and $\frac{1}{90000}$ in.) it was found advisable to employ oblique light from an oil-immersion condenser, and only ten lines of these two latter bands were spanned, the fixed wire being brought to the first ruling of each of these groups, and continuous readings of the movable wire taken as it was screwed up to the edge of each line in succession,* thus every line was spanned with a wholly different portion of the screw, but, nevertheless, the additions of the readings of the first eight lines of the eighth group, and the first nine of the ninth, afford true $\frac{1}{10000}$ in. readings free from screw error, being effected with the same portion of the screw used for the $\frac{1}{10000}$ in. spaces of the first band.

In conclusion, I should mention that it would have been practically impossible to properly effect the above measurements had the micrometer not been supported on a separate pillar-stand designed by Mr. Nelson many years ago. In this way the micrometer is brought close to, but not actually touching; the Microscope tube, thus turning the drum, imparts absolutely no vibration or movement to the most highly magnified image. The common rough-and-ready method of fitting the micrometer into the tube of the instrument itself, in the manner of an ordinary eye-piece, is fatal to accuracy. A micrometer, provided with a screw-traversing frame, carrying both wires, as described, and figured in "Carpenter," would have greatly facilitated the work and have saved much labour. It speaks volumes, however, for the wonderful workmanship of the mechanical stage of Powell's large stand that the fixed wire could be brought into accurate position by such means under the magnification employed. A more crucial test for accuracy of workmanship could hardly be devised by the most exacting microscopist, and I venture to assert that few instruments would satisfactorily withstand such an ordeal.

* The measurements of the lines of bands 4, 5, 6, and 7 were also obtained in this way, the fixed wire being, however, adjusted to the edge of each line of the first three groups. In measuring the five $\frac{1}{10000}$ in. intervals in bands 2, 3, 4, 5, 6, and 7, the fixed wire was accurately adjusted each time. It was not found feasible to adjust the fixed wire so as to obtain five $\frac{1}{10000}$ in. readings throughout bands 8 and 9.

VII.—*On the Visibility of the Tertiaries of Coscinodiscus asteromphalus in a Balsam Mount.*

By EDWARD M. NELSON.

(Read March 16, 1910.)

SOME twelve years ago, when examining a slide of Nottingham deposit, mounted in sulphide of arsenic by Dr. Meates, and kindly presented to me by Mr. Ingpen, I saw for the first time the tertiaries in the *Coscinodiscus asteromphalus*. These tertiaries are formed by a sieve covering the dots surrounding the primary areolations of this diatom.*

A balsam-mounted selected slide of this diatom has been in my box of test-objects since 1876, and it is no exaggeration to say that during that time hundreds of objectives have been tested upon it.

When an objective is tested, an endeavour is made, by means of a large axial cone and deep eye-piecing, to obtain the very utmost that can be got out of the lens, and therefore if these tertiaries had been visible in this balsam mount such an important fact would have been noted.

Towards the end of last month a long tube $\frac{1}{8}$ apochromatic N.A 1.4 was received from Messrs. Zeiss, and in being put through its routine of tests an examination of this old balsam-mounted specimen was made. The tertiaries which had for so many years eluded the grip of all kinds of lenses were conspicuous.

Here, then, we have a definite case: the specimen, the Microscope, the substage condenser,* the lamp, the method of work, and the eye at the eye-end (hardly improved for being twelve years older) were all the same. The only possible explanation why detail formerly invisible should without any particular difficulty now be seen, is that there has been an improvement in the objective.

Microscopists frequently assign improvements in the Microscope objective to definite epochs; for example, the date of its achromatisation, or the date of its apochromatisation. It is true that at these dates the capacity of the objective went up several steps at one bound; but it is also true that several single steps—and shall we say half-steps—were made at other times that were hardly, if ever, noticed by the user of the Microscope.

Some have said that the Microscope objective was apochro-

* Journ. Quekett Micr. Club, vii. (1898) p. 81, pl. 8, fig. 3.

† See this Journal, 1895. p. 229, fig. 32.

matished in 1886, since when there has been no further improvement ; others, better acquainted with practical optics, have predicted that owing to the instability of these new fancy glasses there would be a falling off in the performance of the finest kinds of object-glasses, because manufacturers would only use glass well proved for its stability, the optical qualities of which conform more nearly to the ordinary old-fashioned flints and crowns : but this observation of the tertiaries of *Coscinodiscus asteromphalus* in a balsam mount has proved the fallacy of both these statements.

This apochromatic $\frac{1}{8}$ is more sensitive to tube-length, stands a larger axial cone, bears a deeper eye-piece, and has sharper definition than any Microscope lens I have as yet seen.

SUMMARY OF CURRENT RESEARCHES
RELATING TO
ZOOLOGY AND BOTANY
(PRINCIPALLY INVERTEBRATA AND CRYPTOGAMIA),
MICROSCOPY, ETC.*

ZOOLOGY.

VERTEBRATA.

a. Embryology. †

Embryonic Appendage of Claws of Amniota. ‡—W. E. Agar finds in the embryos of the armadillo *Tolypeutes* and other Mammals, as also in those of chick and lizard, that the claw includes besides the dorsal "Krallenplatte" and the ventral "Krallensohle," a third portion, the neonychium. This is an entirely provisional embryonic structure, which turns the tip of the claw from a hard scratching point into a smooth rounded surface. It is highly probable that its function is to protect the embryonic membranes from being torn by the claws during movements of the embryo. As the time for birth or hatching approaches, the neonychium begins to break away from the rest of the claw, and is probably in most cases rubbed off by contact with the ground directly the embryo emerges, as was shown to be the case in the chick.

Study of Darwinism. §—J. Arthur Thomson has published six lectures on Darwinism delivered in South Africa in the autumn of 1909. They form an introduction to the study of the theory of organic evolution, and bear the following titles: What we Owe to Darwin; The Web of Life; The Struggle for Existence; The Raw Materials of Progress; Facts of Inheritance; Selection: Organic and Social. It was the chief aim of the lectures to explain the gist of Darwinism—what problems Darwin set himself to solve, and what solutions he arrived at, and to indicate what progress has been made as regards the problems of Organic Evolution since Darwin's day—what has been added to Darwinism, what,

* The Society are not intended to be denoted by the editorial "we," and they do not hold themselves responsible for the views of the authors of the papers noted, nor for any claim to novelty or otherwise made by them. The object of this part of the Journal is to present a summary of the papers *as actually published*, and to describe and illustrate Instruments, Apparatus, etc., which are either new or have not been previously described in this country.

† This section includes not only papers relating to Embryology properly so called, but also those dealing with Evolution, Development, Reproduction, and allied subjects. ‡ Anat. Anzeig., xxxv. (190J) pp. 373-80 (7 figs.).

§ Darwinism and Human Life: the South African Lectures for 1909. London (1909) 245 pp.

if anything, has been taken away, and, especially, what is now being reconsidered. An endeavour—necessarily straitened by the limits of the short course of lectures—was also made to suggest how Darwinism touches everyday life, in farm and garden, in city and empire.

Development of Wolffian and Müllerian Ducts in Rodents.*—Casimir Kwietniewski has studied this in guinea-pig and rabbit. In the former the seminal vesicles arise as conical evaginations of the Wolffian ducts; the Wolffian and Müllerian ducts open at first separately on the colliculus seminalis; by an insinking on the colliculus seminalis the Müllerian ducts are drawn into the depression, and the caudal portions of the Wolffian ducts are brought close together; the epithelial partition disappears and the lumen of the united Wolffian ducts coalesces with the caudal ends of the Müllerian ducts; the Müllerian ducts remain as the uterus masculinus. In the rabbit the Müllerian ducts are displaced ventrally by the parts of the Wolffian ducts which coalesce to form "Weber's organ," and take no part in forming this organ.

Development of Bone and Dentine.†—J. Disse discusses the formation of the amorphous ground-substance by the protoplasm of the cells and the differentiation of fibrils within this. These fibrils appear after the ground-substance is separated from the cells, and are quite independent of the cells which form the fibrils.

Involution of Thymus in Rabbit.‡—G. Söderlund and A. Backmann supply precise facts in regard to the changes in the thymus as age increases. When preparations for spermatogenesis begin, i.e. at an age of four months, the weight of the thymus as a whole and of the two parts of the parenchyma (medulla and cortex) reaches a maximum total of 2.49 gm. A rapid decrease sets in, marked especially by the reduction of the cortex.

Development of Lymphatic Ganglia in Mammals.§—J. Jolly and A. Carran have studied the development of the popliteal ganglion in sheep embryos. The first stage is a group of anastomosing lymphatic vessels; the connective tissue between is modified into a primitive nodule, a cellular reticulum; the third stage is marked by the penetration of blood-vessels and the beginning of lymphoid infiltration. At this time the lymph current surrounds the primitive nodule; the penetration of the nodule by the marginal sinus is later. The cortical lymphoid layer, traversed by the sinus, forms both the cortical and the medullary substance.

Development of Auditory Ossicles in Horse.||—Ray F. Coyle finds that the malleus, incus, and stapes are derivatives of the mandibular arch. The stapes and incus are at all times structures distinct from the Meckelian bar, being chondrified independently. The malleus on the other hand is continuous with the proximal end of Meckel's cartilage.

* *Anat. Anzeig.*, xxxv. (1909) pp. 240-56 (13 figs.).

† *Arch. Mikr. Anat.*, lxxiii. (1909) pp. 563-606 (2 pls.).

‡ *Tom. cit.*, pp. 699-725 (1 pl. and 6 figs.).

§ *C.R. Soc. Biol. Paris*, lxxvii. (1909) pp. 640-3.

|| *Proc. R. Soc. Edinburgh*, xxix. (1909) pp. 582-601 (6 pls.).

and the connection between them is of a primary nature. The stapes cannot be homologous with any structure found in the lower Vertebrata, for it is derived from the first arch, whilst the amphibian and reptilian stapes is either derived from the auditory capsule or from the second arch, like the hyomandibular of fishes. The malleus and incus are homologous with the articulare (in part) and the quadrate of the lower groups.

Development of Red Blood Cells in Chick.*—(C. Price-Jones finds that the nucleated red cells of the fowl's blood originate in the embryo from primitive mesoblast cells, and develop by successive stages of "primitive erythroblasts," "metocytes," and "daughter-cells," that result from repeated cell-generations. In each generation a large proportion of the cells have insufficient vitality to attain maturity, and in consequence suffer degeneration; the proportion is greater among the more primitive cells. The author suggests the possibility that the products of each successive series of degeneration may constitute the stimulus for the development of less primitive forms into the next higher condition of cell, or may be the origin of anti-bodies to the primitive forms, constituting an immunity to these forms and inhibiting their further production.

Development of Subdivisions of Pleuroperitoneal Cavity in Birds.† Margaret Poole has re-investigated this subject, and confirms the results of Bertelli and of G. W. Butler. She also compares the subdivisions of the cœlom in reptiles and birds, noting, for instance, that on the whole the condition in the Crocodylia seems to approach most nearly to that in birds, yet the manner of the exclusion of the lungs from the peritoneal cavity in the latter is far more like what occurs in *Testudo*, and probably also in the Varanidæ.

Development of Vertebral Column in Grass Snake.‡—Erna Brünauer finds that in *Tropidonotus natrix* the first primordium of the axial skeleton appears in the form of band-like thickenings, the hints of the bases of the arches, the transverse processes, and ribs. The vertebræ arise from the perichordal sheath and are at first distinguishable from the bases of the arches, with which they subsequently fuse. The chondrification proceeds from three groups, one in the centrum, the others in the dorsal part of the neural arch. Ossification is prefaced by the degeneration of the cartilage in the centre of the centrum. The deposition of bony lamellæ proceeds from the ventral and dorsal aspects of the centrum, and from four spots on the neural arches. The inter-vertebral ring appears in early stages as a boundary line in the sclerotome. It consists of fibrous connective tissue and becomes implicated in the articulation. The notochord shows inter-vertebral constrictions; in the course of development it is almost completely constricted, first within the joint and then in the vertebral region as well. In the trunk region there are unpaired intercentra; in the tail they form paired inferior arches, pushed cranium-wards on the centra.

* Journ. Pathol. Bacteriol., xiv. (1909) pp. 218-23 (1 pl.).

† Proc. Zool. Soc. London, 1909, pp. 210-35 (14 figs.).

‡ Arb. Zool. Inst. Univ. Wien, xviii. (1910) pp. 133-56 (2 pls. and 2 figs.).

Abortive Embryo of Salamandra atra.*—H. Hirzel has studied an abortive accessory embryo, which shows a monstrous dilatation of the body-wall. The nervous system is normal or nearly so, and the ectodermic products generally are less divergent than the mesodermic and endodermic organs, such as the rudimentary and peculiar representatives of heart and lungs.

Development of Hyobranchial Skeleton in Salamandra atra and Triton alpestris.†—Helena Tarapani gives a careful account of the development of the hyoid and branchial arches in the larvæ of these Urodela, and of the retrogressive changes and new formations which lead from the larval skeleton to the definite support of the tongue. Some beautiful reconstructions are photographed.

Spermatogenesis in Alytes obstetricans.‡—F. A. Janssens and J. Willems describe (*a*) the "somatic kinesis" of the mother sperm-cells, the twin chromosomes, and the behaviour of the nucleoli; (*b*) the maturation kinesis, the zygosomes, the amphitæne stage, the pachytæne stage with dyads, the dyads in a ring, and so on.

Hypochord in Skate Embryos.§—W. T. Gibson discusses this structure—the sub-notochordal rod of many embryologists—as it appears in embryos of *Raja batis*. It is practically co-extensive with the embryonic gut and with the notochord until the formation of the latter ceases posteriorly. It is derived from the chorda-hypoblast, and it never loses touch with the notochord except within the last stages of degeneration. It ends its existence within the embryonic period, disappearing long before the notochord reaches its maximum size. It is confined to the Ichthyopsida, and is probably in some way "useful to the notochord."

The author also discusses the epibranchial groove. Vestiges of it occur in embryos of reptiles and birds, and of the skate; the theory is suggested that the air-bladder may be derived from it.

Metameres of Petromyzon.||—B. Hatschek finds that the paired mesoderm bands exhibit a thorough-going segmentation, hyposomatic as well as episomatic, resulting in primitive segments like those of the lancelet. At a stage when the primitive segments are defined, and so far differentiated that their parachordal myoblasts extend through the entire length of the segments, the first mandibular segment (mesodermic acromerite) is still in process of being constricted off from the endoderm. The formation of myoblasts is at this stage still lagging in the second, third, and fourth segments. The archencephalon (first and second primary vesicles) corresponds in its extent to the mandibular segment, and belongs to the acromerite. The first visceral pouch is intersegmental, its anterior wall belonging to the acromerite, its posterior wall to the second segment.

* Jenaische Zeitschr. Naturw., xlv. (1909) pp. 1-56 (3 pls.).

† Tom. cit., pp. 57-110 (6 pls.).

‡ La Cellule, xxv. (1909) pp. 151-78 (2 pls.).

§ Anat. Anzeig., xxxv. (1909) pp. 407-28 (13 figs.).

|| Morphol. Jahrb., xl. (1909) pp. 480-99 (2 pls. and 1 fig.).

Placentation in Tatu.*—H. H. Lane has studied the habits and placentation of *Tatu novemcinctum* var. *texanum*, the only Edentate living in the United States at the present time. It gives birth usually to four young in a litter. The uterus is simple and globular, the oviducts are only slightly convoluted. Each fœtus develops within its own amniotic sac, though a common chorionic vesicle serves for all. While the evidence is not decisive, the fact that the young were all of the same sex in the case studied, as well as the fact that all lie within a common chorionic vesicle, may be held to favour the view that there is polyembryony (von Jhering, Newman and Patterson), and that the sex is determined in the fertilised ovum. The chorionic villi vary from short simple ones to long arborescent ones. The short villi form two longitudinal bands, separating two discoidal areas of the long villi. The placenta is of a deciduate type intermediate in form between the zonary and the discoidal. It does not conform exactly to Strahl's placenta zono-discoidalis, and may be called placenta zono-discoidalis indistincta. There is no decidua capsularis.

Litter of Hybrid Dogs.†—R. R. Gates describes the progeny of a thoroughbred Old English Bobtailed Sheep Dog (the mother) and a thoroughbred Scotch Collie (the father). In no character was there complete dominance of one parent in all the offspring. There was remarkable diversity in the litter. There is a tendency as regards a given character for the offspring to "take after" one parent or the other, though in certain cases, as in the character of the hair, there is a marked departure from either parent. This is, perhaps, the reappearance of a character derived from some cross in the ancestry of one of the breeds.

b. Histology.

Motor End-plate in Higher Vertebrates.‡—J. Boeke has made a comparative study of the structure and development of the motor end-plate. He finds that the motor end-plate is not the real terminus of the conducting element, which is only bound to the muscle by the contact of "sole-plate." Very fine fibrils arise from the motor plate in which the motor fibre attains a large surface in a system of neurofibrils. These very fine fibrils enter into union with the contractile substance, forming an extremely fine reticulum between the cross-striped myofibrils.

Musculature in Villi of Small Intestine.§—A. Trautmann has studied this in domestic animals. The origin of the musculature (of the main mass at least) is in the muscularis mucosæ, from which muscle-fibres diverge and pass up between the glands into the propria mucosæ, forming a number of bundles up the villus. The bundles end in connective tissue fibres, which end on the sub-epithelial membranes. Perhaps some muscle fibres go directly to these. The muscle bundles in the villus are surrounded by fine nets of delicate elastic fibres.

* Bull. State Univ. Oklahoma, i. (1909) pp. 1-18 (3 figs.).

† Science, xxix. (1909) pp. 744-7.

‡ Anat. Anzeig., xxxv. (1909) pp. 193-226 (40 figs.).

§ Op. cit., xxxiv. (1909) pp. 113-25 (1 pl.).

Epidermic Papillæ in Euproctus.*—L. Roule calls attention to the small epidermic protuberances which occur over the body of some Urodela, such as *Euproctus*, and shows that in their structure they may be fairly compared with the hairs of Mammals.

Study of Nervous Systems.—D. Tretjakoff,† gives an account of the minute structure of the spinal cord in the larval lamprey, and compares it with that of *Amphioxus* on the one hand and with that of higher Vertebrates on the other.

J. Belogolowy ‡ has studied the development of the cranial nerves in the chick. He describes their histogenesis and discusses their morphological significance.

Peripheral Terminations of Eighth Cranial Nerve.§—R. C. Mullenix has studied this with special reference to *Fundulus*, a Teleostean fish. Between the supporting cells and the layer of the sensory cells is a region which is rich in nervous material, in the form of an entangled mass of fibres which extend in various directions. In this so-called nerve plexus the author found no case in which the neurofibrillæ of one axis cylinder were in undoubted continuity with those of another axis cylinder. In the ear, at least, we have a portion of the peripheral system in which the conditions are such as to furnish strong anatomical evidence in support of the neurone theory—the theory which regards ganglion cell, dendrite and axis cylinder as together constituting the structural unit of the nervous system. In the case of *Fundulus*, the absence of anastomosis between different axis cylinders, the distinctness of the sense-cells, and the free terminations of the axis cylinders, support the validity of that view.

Innervation of Tympanum.||—Agostino Gemelli describes, in reference to horse, ox, cat, etc., the tympanal ramifications (1) of the auriculo-temporal branch of the trigeminal, and (2) of the nerve of Jacobson—a branch of the glossopharyngeal. He gives an account of the various plexuses formed and of the terminations in the cutaneous, mucous, and fibrous layers.

Mammalian Blood Studied with Dark-field Illumination.¶—Howard Crawley proclaims the advantages of this method, and describes what he has seen in the way of "blood-dust," beaded threads, flagellated erythrocytes and free flagella, bodies with pseudopodia, erythrocytes, leucocytes, and blood-plates.

Phenomena of Synaptic Phase.**—V. Grégoire discusses the phenomena of synapsis, the formation of gemini, and the rest. He cannot accept the view that the synapsis represents an abortive karyokinesis. It is the first and fundamental stage in the heterotypic or reductional prophase.

* Comptes Rendus, cl. (1910) pp. 121-3.

† Arch. Mikr. Anat., lxxiii. (1909) pp. 607-80 (3 pls.).

‡ Bull. Soc. Imp. Nat. Moscou, ann. 1908 (published 1909) pp. 177-325 (9 pls.).

§ Bull. Mus. Comp. Zool. Harvard, liii. (1909) pp. 215-50 (6 pls.).

|| La Cellule, xxv. (1909) pp. 119-27 (1 pl.).

¶ Bureau of Animal Industry, U.S. Dept. Agric., Bull. 119 (1909) pp. 5-15.

** La Cellule, xxv. (1909) pp. 87-99.

Vesicular Secretion.*—A. N. Mislawsky has studied the process of secretion in the superficial mandibular gland of the rabbit, which is not a salivary gland, but nearer the axillary gland in man and the interdental gland in ruminants. It illustrates the so-called "vesicular" secretion. The secreted material accumulates at the distal portion of the cell, which bulges out like a dome and is extruded into the lumen of the gland. Mislawsky shows that there is an intense nuclear multiplication on the part of the glandular cells.

Junction of Papillary Muscle and Chordæ Tendineæ.†—Montgomery P. Paton has studied this mode of attachment in view of the fact that there is no true sarcolemma over the cells of the cardiac syncytium. The apex of the musculus papillaris is ensheathed by a covering of dense fibrous tissue, continuous with the endocardium. The chordæ arise from the free surface of this investment or helmet, while from its deep aspect numerous well-developed trabeculæ descend and freely ramify amongst the cardiac muscle-cells. It is here that the junction of the cardiac syncytium and the chordæ tendineæ occurs. The more central of the fibres or trabeculæ insinuate themselves in the most intimate fashion between the muscular elements, so that there results an interdigitating system of fibrous tissue and cardiac muscle. The interstitial cement material is therefore responsible for the strength of the junction.

Mast-cells and Plasma-cells.‡—L. H. Huie discusses these elements. She records the mitosis of the former in the skin of foetal mice. She does not find any plasma-cells in Malpighian corpuscles or in germ centres. They are abundant in the splenic pulp and in the sinuses of lymphatic glands. Their lymphocyte nature must be excluded. They seem to arise from the endothelial cells lining the blood-vessels.

Changes in Nuclei in Varying Physiological Conditions.§—E. Wace Carlier gives a brief account of some of the changes exhibited by nuclei during and subsequent to functional activity and points out the danger of interpreting normal phases as pathological.

c. General.

Reaction of Marine Organisms to Light and Phosphorescence.|| Benjamin Moore has experimented chiefly with nauplii of *Balanus*. The characters of the response are not constant, but vary for the same organism according to the intensity of the light and the previous history of the organism in regard to light. As a general rule, the organism is positive to feeble light and negative to stronger light, and for a constant intensity of light at a given moment, previous darkness, or weak stimulation, tends to turn organisms positive, and previous exposure to bright light turns them negative.

Both the positive and negative behaviour to light may be explained

* Arch. Mikr. Anat., lxxiii. (1909) pp. 681-98 (1 pl.).

† Proc. Scot. Micr. Soc., v. (1909) pp. 22-3.

‡ Tom. cit., pp. 37-41 (1 pl.).

§ Tom. cit., pp. 82-6 (1 pl.).

|| Trans. Liverpool Biol. Soc., xxiii. (1909) pp. 1-34.

on the basis of one chemical action of light upon the cell (a katabolic one). The positive state indicates that the speed of reactions in the cell lies below a certain value, which may be called the optimal value, and the negative state corresponds to a speed of reactions in the cell above the optimal value. In the former case the sentient surfaces are turned into the light to increase velocity of reaction up towards the optimal value; in the latter case the sentient surfaces are turned away from the light so as to decrease the velocity of the reactions down towards the optimal value.

As a result of the orientation so caused, there arises movement of the organism towards or away from the source of light, but such orientation is not a fixed orientation, but rather a steering action; the animals, as a result, do not remain in one fixed plane, or direction of movement, but the net result of the movement is that the organisms move to or from the light. In the case of young plaice, the animals may be in all possible planes of orientation to the light when the movement is finished.

In the nauplii of *Balanus* movement towards or away from the light has an associated movement upwards or downwards. These two movements would coincide in natural conditions. Addition of small amounts of acid or alkali was not found to alter the reactions to light. The rate of movement is almost the same with different intensities of light and different coloured lights, showing that the locomotor apparatus is not affected by the light, but continues to work at the same rate. The nauplii moved from red light to blue light, and from blue to green. Movement in converging and diverging light is described, and shown to be explicable on the basis of intensity of light alone. Direction produces its effects in a secondary manner on account of the light and shade effects of the animal's own body.

Phosphorescent Copepods were found to be indifferent in regard to movement to light from without. That light from without has another type of influence upon these phosphorescent organisms is shown, however, by the fact that their periods of activity and rest in regard to phosphorescence follow respectively the hours of daylight and darkness. This alternating diurnal periodicity may persist for twelve days in the absence of the accustomed recurring stimulus of day and night. The phosphorescence is spontaneous. When freshly taken the organisms show a faint persisting light, with flashes at intervals. At a later period the light disappears entirely between the flashes, which have a longer interval between them. Under probably pathological conditions, after the organisms have been confined for a considerable period, there may be lighting up of the organisms with a continuous glow.

The appearance of the spontaneous phosphorescence at nightfall and its disappearance at dawn are characterised by the same changes in a reversed order in the two cases. Before the appearance of spontaneous phosphorescence at night, and after its disappearance in the morning, there is a period of minimal excitability of about half-an-hour, during which stirring still calls out phosphorescence. After this the organisms became completely refractory.

Additions of fresh water, or formol, produce, during the period in which the organism is dying, a most vivid phosphorescence, which lasts

for two or three minutes and then fades and disappears. This display is very feeble during a daylight period compared to what is seen after dark, when spontaneous phosphorescence is present.

Temporal Region in Vertebrates.*—Hugo Fuchs takes a comparative osteological survey of this region of the skull in quadrupedal Vertebrates.

Morphological Significance of Sacral Ribs.—Hugo Fuchs † discusses the view that the sacral ribs of the crocodile are not homologous with dorsal ribs, but with transverse processes. Transverse processes are never separated off by sutures from the neural arch. The sacral ribs of the crocodilians are always so separated off, and they are homologous with ordinary ribs.

Roy L. Moodie ‡ discusses the same question, and concludes that the sacral rib does not differ from a dorsal rib except in function and form.

Significance of the Entochorda.§—S. A. Ussoff regards the entochorda as a “collective organ,” comprising various primordia which have not been developed. Thus, in the head of Anura it develops at the expense of those endodermic primordia which appear as a result of the attempt of the gut to unite with the “stomodæum-ectochorda”—the front end of the notochord. This is merely an illustration of the author’s interpretation.

Study of the Notochord.||—L. Roule maintains that the primary embryonic form is hollow—a diverticulum of the gut (cordocœl) or an enteric groove (cordoglyph). The former is seen in Enteropneusts and Tunicates, the latter in Cephalochorda and Craniota. The solid type or rhabdocord is secondary. Roule’s views are summed up in this scheme :

		Type du Cordocœle	Type du Cordoglyphe
		CRANIOTES
NOTONEURES	{	RHABDOCORDÉS	{
		{
		{	ACRANIENS
		UROCORDÉS	Tuniciers
		CÆLOCORDÉS Enteropneustes
			..

Vibrissæ on Cats’ Arm.¶—F. Fritz describes what Beddard has called carpal vibrissæ. About 2½ cm. above the carpus there are 3–6 tactile hairs projecting from a wart-like tubercle. The minute structure of the region, including the innervation, is described in detail.

New Insectivore.**—E. L. Trouessart gives a short account of *Neotetracus sinensis* g. et sp. n., from Western China—a small animal about the size of a wood mouse (*Mus sylvaticus*) with very long hind legs. Its dentition approaches that of the hedgehog, but it has a Gymnurine pelage. It seems to lead to a union of the two sub-families, Erinaceinæ and Gymnurinæ.

* Anat. Anzeig., xxxv. (1909) pp. 113–67 (25 figs.).

† Op. cit., xxxiv. (1909) pp. 349–56 (2 figs.).

‡ Tom. cit., pp. 361–4.

§ Op. cit. xxxv. (1909) pp. 168–76 (10 figs.).

¶ Arch. Zool. Expér., x. (1909) pp. 447–546 (4 pls.).

** Zeitschr. wiss. Zool., xcii. (1909) pp. 291–305 (1 pl. and 2 figs.).

** Comptes Rendus, cxlix. (1909) pp. 950–2.

Agriotype of Domestic Asses.*—R. I. Pocock calls attention to the large black or dark brown patch which almost always marks the base of the ear in domestic asses. So constant is this feature that it is impossible to avoid the conclusion that it has been inherited from their ancestral form. If this be so, that ancestral form was not *E. asinus africanus*, nor *E. asinus tæniopus*, nor *E. asinus somaliensis*, in which the ears are decidedly black or brown behind or at the tip, the basal patch being evanescent. There is some evidence of a Nubian wild ass with a distinct patch.

Organ of Jacobson in Ant-Bear.†—R. Broom has studied this in a recently born specimen of *Orycteropus*. As the organ seems to be less affected by change of habits than almost any other, it is of great importance in revealing the obscured affinities of aberrant forms. On the whole, the condition in *Orycteropus* comes nearest to that in Marsupials, but there are many points of difference. The evidence would seem to point to *Orycteropus* being descended from a line of ancestors the earlier members of which were probably allied to Marsupials, whilst the later members branched off from the Eutherian stem before any of the higher Eutherian types had been specialised. If the *Orycteropus* line ever coincided with that of *Dasybus*, the two must very early have diverged.

Classification of Edentates.‡—H. H. Lane believes that the Edentates transcend the limits of an "order." They may be regarded as a super-order, comprising four orders:—

Tæniodonta (Cope)	. Conoryctidæ, Stylinodontidæ.
Xenarthra (Gill)	. Bradypodidæ, Megalonychidæ, Megatheriidæ, Myrmecophagidæ, Orophodontidæ, Dasy- podidæ, Glyptodontidæ.
Pholidota (Weber)	. Manidæ.
Tubulidonta (Flower)	. Orycteropodidæ.

It is suggested that the orders diverged from some ancestral group at present unrecognised, and that the Tæniodonta are more nearly related to the Xenarthra than to the other orders.

Seminal Vesicles and Infection.§—R. H. J. G. Huet has studied the seminal vesicles in horse, bull, ram, goat, etc. He finds that there may be micro-organisms in the seminal vesicles of healthy animals. In the secretion of the seminal vesicles of animals which died of acute septicæmia the specific micro-organisms were present. Virus may be transferred in act of coition. In artificially infected animals the virus lingers in the seminal vesicles after it has apparently disappeared from the circulation and from the parenchymatous organs.

Mechanism of Respiration in Lizard.||—Ch. E. François-Franck describes the costo-sternal and muscular apparatus in the lizard (*Lacerta ocellatus*), and gives an account of his observations on the respiratory movements. He also discusses the structure of the lung, its contractility, the innervation, and the process of respiration in general.

* Ann. Nat. Hist., iv. (1909) pp. 523-8.

† Proc. Zool. Soc., 1909, pp. 680-3 (1 pl.).

‡ Bull. State Univ. Oklahoma 1909, No. 2, pp. 21-7.

§ Centralbl. Bakt. Parasitenk., lii. (1909) pp. 477-97.

|| Arch. Zool. Expér., x. (1909) pp. 547-615 (61 figs.).

Ribs of Urodela.*—Franz Mayerhofer discusses the morphology of the ribs in Urodela, with special reference to their development in the salamander. He concludes that rib and transverse process are genetically and morphologically related; they are independent parts of one piece which divides proximally and sometimes also distally; that a comparison with fishes makes it probable that the rib is a lateral outgrowth of the hæmal arch, and the transverse process to another lateral outgrowth of the same.

New Parasitic Fish.†—J. Pellegrin has an interesting note on *Vundellia wieneri* sp. n., a small Silurid from South America (Rio Napo), which, like two other species, lives on the gills of *Platyostomus*. It fixes itself and rasps off the skin by means of the teeth and the opercular scales. The buccal cavity is adapted for facilitating the engulfing of blood. The author distinguishes it from the two other species.

Species of Three-spined Sticklebacks.‡—C. Tate Regan finds that *Gastrosteus aculeatus* is very variable. Specimens from the north have a strong dermal ossification, the series of bony plates is complete, the caudal keel is prominent: specimens from the south have a weaker dermal ossification, and if the bony plates form a complete series, they are not so deep, nor usually so numerous as in northern marine examples, and the caudal keel is less prominent. There are also other differences. As synonyms of *G. aculeatus*, Regan includes all the three-spined species hitherto described, with the exception of *G. algeriensis*, which has 29 vertebrae. In *G. aculeatus* there are 3 (2 to 5) spines and 9 to 14 dorsal rays, 1 pelvic spine, 7 to 11 anal rays, and 31 to 33 vertebrae. The snout is shorter than the postorbital part of the head, and the first dorsal spine is inserted nearly above the base of the pectoral fin, and well in advance of the pelvic spine. The author establishes two new species—*G. halogymnus*, from Rome, with no bony plates, and *G. santæ-annæ*, from California.

Aortic Ligament of Shad.§—R. H. Burne describes the ligamentum longitudinale ventrale of a shad (*Clupea alosa*). It lies in the aorta suspended by a longitudinal fold of its dorsal wall—a tight band of elastic tissue. The late Professor Charles Stewart suggested the interpretation which the author adopts, that in the flexions of the body in swimming the ligament remains practically stationary, owing to its tension, and will, in effect, form a series of diagonal curtains passing regularly in succession down the length of the aorta. Each curtain will, of necessity, push the blood before it. The faster the fish swims the faster will the blood flow. The ligament is apparently formed around, though not actually from, the subchordal rod. The author has notes on the elastic ligaments of the skate's gill-pouches, and on the plate of elastic tissue on the anterior wall of the capsule of the costo-vertebral joints in a python—which helps in the protraction of the ribs.

Antarctic Macrurid.§—Louis Dollo discusses *Nematourus lecointei*, an abyssal Macrurid found by the Scottish Antarctic Expedition under

* Arbeit. Zool. Inst. Univ. Wien, xvii. (1909) pp. 309–58 (2 pls. and 9 figs.).

† Comptes Rendus, cxlix. (1909) pp. 1016–17.

‡ Ann. Nat. Hist., iv. (1909) pp. 435–7.

§ Proc. Zool. Soc., 1909, pp. 201–4 (3 figs.).

§ Proc. R. Soc. Edinburgh, xxix. (1909) pp. 488–98.

Dr. W. S. Bruce, in the zone between 60° S. and the Antarctic circle. It was previously obtained by the 'Belgica' within the Antarctic circle. He points out that the Macruridæ, like other fishes, are unfavourable to the theory of Bipolarity, since there is no species or genus common to the Arctic and Antarctic waters.

Cranial Anatomy of Mail-cheeked Fishes.*—Edward Phelps Allis completes his account of the structure of the head in the Loricati. He discusses the bones, nerves, sensory canals, and blood-vessels in detail and comparatively, and the position of particular types, such as *Cottus* and *Dactylopterus*. He pays particular attention to the myodome, in *Dactylopterus*, for instance. The myodome of fishes is primarily a subpituitary space that is connected with the orbit of either side, or with the orbital region, by a canal that transmits the pituitary vein. Secondly, this subpituitary space acquires a wide communication with the orbits, the primal cause of this secondarily acquired communication apparently being a deepening of the hind ends of the orbits, due to a marked enlargement of the eyeballs. Following this deepening of the orbits, certain of the eye-muscles of either side enter the pituitary canal, and, enlarging that canal, finally wholly break down the wall that separates the orbits from the subpituitary space. It seems possible that the subpituitary space may represent the conical depression on the anterior surface of the body of a vertebra, the later acquired, posterior, or basi-occipital extension of the myodome possibly being due to the assimilation of similar depressions in more posterior vertebrae.

Supposed Evidence of Mutation in Malthopsis.†—R. E. Lloyd reports on the deep-sea fishes caught by the 'Investigator' in the Indian Ocean since 1900, describing five new genera and nineteen new species. The collection includes five types of the genus *Malthopsis*, and there is some evidence that they illustrate mutation, round *M. lutea*, as regards their shape and their dermal ossicles. Among the offspring which the members of the species are producing, are some which differ widely from their parents as regards shape and ossicles, and the same kind of difference is occurring in widely separated localities.

Study of Heart-action in Fish Embryos.‡—A. v. Tschermak has studied the action of the heart in embryos of *Gobius* and *Scyllium*, and also in young lampreys. He finds that the embryonic heart has from the beginning of its activity the fundamental characteristics seen in the adult heart—the refractory phase, the compensatory pause after extra-systole, the maximum reaction, and so forth. There are, indeed, peculiarities in the embryonic heart, but the essential features are the same as in the adult, which shows that the establishment of innervation is not indispensable. The essential myogenic properties of the heart are eventually modified in a characteristic way by the neurogenic conditions.

Olfactory Organ of Teleosteans.§—R. H. Burne has studied the structure of the olfactory organ in 51 genera of Teleostei. It may be

* Zoologica, xxii. (1909) Heft 57, pp. 145-219 (2 pls.).

† Memoirs Indian Museum, ii. No. 3 (1909) pp. 139-80. See also Illustrations of the Zoology of the Investigator Fishes, part x., pls. xlv-1.

‡ SB. Akad. Wiss. Wien, cxviii. (1909) pp. 17-115 (2 pls. and 25 figs.).

§ Proc. Zool. Soc., 1909, pp. 610-63 (26 figs.).

divided into the essential olfactory chamber with its rosette, and the accessory nasal sacs which are of secondary importance. The author discusses the varieties in the form of the openings, the occurrence of valves in some forms, the varieties in the rosette and in the accessory sacs. Water may play on the laminae of the rosette by the action of cilia within the anterior nostril and upon the lining membrane of the olfactory chamber, or by the deflection of water into the nose-cavity during forward progression, or by the alternate dilatation and compression of accessory sacs connected usually with the hinder part of the olfactory chamber. Bateson has shown that practically all Teleostei seek their food by sight; perhaps the rhythmical currents in the nose may be of some use in testing the water used for respiration. There seems to be very little evidence of any relation between the characters of the olfactory organ and the habits of the fish.

Mesencephalic Nerve in Ammocœtes.*—D. Tretjakoff describes a very delicate nerve arising on each side from the mid-brain. It is the *N. thalamicus* of Hoffmann, but is more correctly called *mesencephalicus*. It represents the second true metameric nerve of the front of the head.

Variation in Mullet.†—L. Fage has studied the different appearances of mullet, distinguishing those due to age, to sex, and to habitat. He shows that the Linnean species *Mullus barbatus* and *M. surmuletus* are connected by intergrades; indeed *M. surmuletus* may be regarded as an arrested form of the more evolved *M. barbatus*. He sums up in this schema:—

<i>M. barbatus</i> L.	{	forma typica	{	southern type
		var. <i>surmuletus</i> L.		northern type

Zoology of Ruwenzori.‡—W. R. Ogilvie-Grant organised an expedition to the "Mountains of the Moon," or Ruwenzori range in Equatorial Africa, and he writes a preface to the zoological results. The collections made included thousands of specimens, e.g. 404 Mammals, 2470 Birds, 135 Reptiles and Amphibians, 31 Fishes, 12 Crustaceans, 100 Arachnids, 1015 Beetles, and so on. An itinerary by R. B. Woosnam, who led the expedition, is followed by reports on the Worms (F. E. Beddard), Molluscs (E. A. Smith), Crustaceans (W. T. Calman), Arachnids (A. S. Hirst), Neuroptera and Orthoptera (W. F. Kirby), Rhynchota (W. L. Distant), and Diptera (E. E. Austen).

INVERTEBRATA.

Mollusca.

a. Cephalopoda.

Development of Cœlomic and Vascular Systems in Loligo.§—Adolf Naef gives an account of this intricate development. Some of his conclusions may be briefly stated. The blood-vessels arise as spaces in the originally thick "mesoderm." Their walls are formed by the

* Anat. Anzeig., xxxiv. (1909) pp. 151-7 (3 figs.).

† Arch. Zool. Expér., i. ser. 5 (1909) pp. 389-445 (1 pl.).

‡ Trans. Zool. Soc. London, xix. (1909) pp. 1-100 (3 pls. and 12 figs.).

§ Jenaische Zeitschr. Naturwiss., xlv. (1909) pp. 221-66 (3 pls. and 14 figs.).

mesoderm cells bounding the spaces. There is no genetic connection between the cœlothel and the vascular walls. The arterial heart arises from paired primordia which unite in the middle line. Paired clefts in the "mesoderm" form the pericardial primordia, which meet in the middle line. About the same time the kidneys arise from the mesoderm as two distinct solid primordia, which are from the first in close relation with the venæ cavæ. The cœlomic system consists of the paired renal cavities and the pericardial cavity, which are connected both as regards cavities and epithelial lining. Naef emphasizes three points: that there is no primary connection between kidney and pericardium; that the pericardium has never any direct connection with the exterior; and that the primordium of the heart has no connection with a sinus of the hind-gut; indeed this sinus, which Distaso described, is the primordium of the genital veins.

Catalogue of Recent Cephalopods.*—W. E. Hoyle brings his list of cuttlefishes up to 1906; this second supplement dealing with the period 1897–1906, and recording 69 new specific names and 29 new genera, 10 of which, however, are divisions or re-namings of older genera.

B. Gastropoda.

Revision of Chitons.†—Joh. Thiele completes his revision of the order Placophora, and indicates his view of the relationship of the families and sub-families in the following schema:—

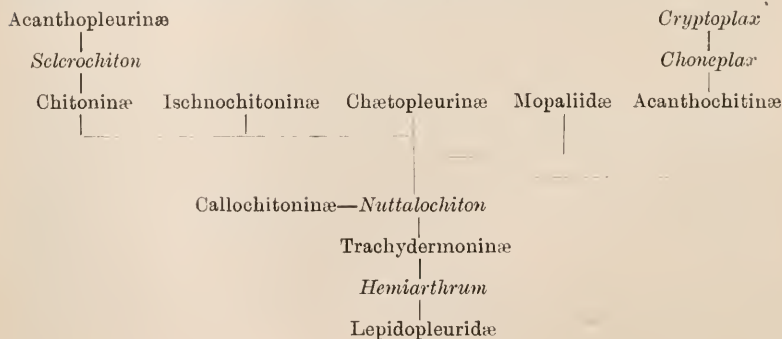

Eyes of Placophora.‡—M. Nowikoff has studied the intra-pigmental eyes of *Chiton* and *Callochiton*, comparing them with the other types of eye that occur. There are two types of intra-pigmental eye, for that of *Chitoninae* is different from that in *Callochitoninae*, and both are different from the extra-pigmental eyes in *Toniciinae* and the rather more complex forms in *Liolophurinae*. Yet all the three types seem to be derivable from one and the same material, the cells of the megalæsthete. The eyes do not seem capable of more than distinguishing between light and shade, and probably help the animals to keep away from muddy water.

* Proc. Roy. Phys. Soc., xvii. (1909) pp. 254–99.

† Zoologica, xxii. (1910) Heft 56, pp. 71–124 (4 pls.).

‡ Zeitschr. wiss. Zool., xxxix. (1909) pp. 668–80 (1 pl. and 2 figs.).

Growth of Limpet's Shell.*—E. S. Russell has studied (1) the rate of growth in the limpet's shell (taking the size of the shell as a measure of its growth), and (2) the gradual change in the shape of the shell as it grows in size. His conclusions are the following: 1. The breeding season extends from July to January. 2. Sexual maturity is reached at a length of 20–25 mm. 3. An average size for a limpet of the last season's brood in January or February is 10 mm. At the end of the first year it may be 29 mm. long. Probable sizes at the end of the second and subsequent years are 38, 44, 48, and 53 mm. Shells over 50 mm. may be considerably more than five years old. 4. Sexual maturity is reached in the first year, and when the limpet is only half-grown. 5. The rate of growth decreases with age and maturity. It is slower during the colder months of the year. 6. Considerable change takes place in the ratios of the shell dimensions during growth. 7. These changes are probably, in large part, the expression of "laws of growth," and not due to natural selection.

Hermaphroditism in *Crepidula fornicata*.†—J. H. Orton discusses this interesting Calyptraeid, which has been imported to England from America along with oysters, and has established itself on the coast of Essex and Lincolnshire. Individuals have the habit of associating permanently in linear series, one on the top of another, forming "chains"—sometimes of as many as twelve. All the young are able to creep about, but the adults are sedentary. The individuals in a chain offer a transitional series, from maleness to femaleness, both in primary and secondary sexual characters. Since all the young ones are males, the species is a protandrous hermaphrodite. Dwarf females occur as "physiological variations."

Allied species and a species of an allied genus will very likely be shown to be likewise protandrous, and there is good reason for thinking that this condition may be even more widely spread among the Streptoneura. "Since the males in *Crepidula fornicata* change into females, it would seem in this case that it is the male which possesses the potentialities of both sexes. A solution to this problem is offered, if, as seems likely, allied species present an evolutionary series in the acquisition of protandric hermaphroditism."

Classification and Distribution of Helicidæ.‡—H. von Ihering divides the Helicidæ into five new sub-families:—1. Hygromiinae (including *Hygromia* Risso (*Fruticicola* Held), *Eulota* Hartm., *Helicodontu* Fer. (*Gonostoma* Held), *Lysinöe* H. and A. Ad., *Acanthinula* Beck, *Vallonia* Risso. 2. Helicellinae, including *Helicella* Fer. (*Xerophila* Held.), and *Leucochroa* Beck. 3. Cepolinae, including *Cepolis* Montf. and *Polymita* Beck. 4. Heliocostylinae, including *Helicostyla* Fer. (*Cochlostyla* Fer.), and *Chloræa* Alb. 5. Helicinae, including *Helix* (L.) Ih., *Helicigona* Fer. (*Campylæa*, *Arianta*, etc.), and *Leptaxis* Lowe.

He discusses the Atlantis theory of Heer and his own Archhormis theory, and the probable migrations of Helicidæ in the past. Two "elementary laws of distribution" are formulated:—1. Terrestrial animals,

* Proc. Zool. Soc., 1909, pp. 235–53 (1 pl.).

† Proc. Roy. Soc., B, lxxxii. (1909) pp. 468–84 (3 figs.).

‡ Verh. Zool. Bot. Ges. Wien, lix. (1909) pp. 420–55 (1 map).

of more or less cosmopolitan distribution, that occur in South America, are not autochthonous there, but immigrants from the northern hemisphere. 2. The autochthonous animals of South America have spread by migrations through Central America to the south of the United States, but in no single case beyond America to the palæarctic region.

Monograph of West American Pyramidellidæ.*—W. H. Dall and P. Bartsch have executed a laborious task in this monograph of a family of Gastropods, the members of which are mostly of minute size. The distribution is world-wide. There are four main genera—*Pyramidella* Lamarck, *Turbonilla* Risso, *Odostomia* Fleming, and *Murchisonella* Mörch, with a large number of sub-genera.

δ. Lamellibranchiata.

Postembryonic Development of Unionidæ.†—W. Harms begins by giving a fresh description of the glochidia of *Anodonta*, *Unio*, and *Margaritana*, and he also refers to the peculiar *Lasidium*-larva of the South American mussel, *Glabaria*, one of the Mutelidæ, in which a parasitic stage has not been discovered. The transition to parasitism is then discussed, in connection with which it is noted that tadpoles, *Proteus*, and axolotl may be infected, as well as fishes. Only in the axolotl, however, does development complete itself. Harms then proceeds to the main subject of his investigation, the changes that go on in the parasitic period, leading to the definitive mussel form.

Arthropoda.

Muscle-insertions in Arthropods.‡—R. H. Stamm discusses the insertion of muscles in the chitinous skeleton of Arthropods, and defends against other observers the conclusion which he arrived at in 1904, that the insertion is always "indirect." The typical cross-striated muscle-substance never reaches the chitin, but is always separated from it by a longitudinally striated tendon, which is due to modified hypodermis cells.

a. Insecta.

Mouth-parts of Wasps and other Hymenoptera.§—R. Demoll gives an account of the mouth-parts in Vespidæ, Tenthredinidæ, and Uroceridæ, and describes what seems to be an olfactory organ at the end of the labial palpi of *Sirex gigas*.

Brain of Hive-bee.||—C. N. Jonescu gives a detailed comparative account of the complex brain of the hive-bee. The supra-oesophageal ganglion has its protocerebrum (with several subdivisions), its deutocerebrum, and its tritocerebrum; the sub-oesophageal ganglion is triple. The origin of the various nerves from the brain is described. Some of the comparisons of the brains of queen, worker, and drone are very interesting. The worker has, as is well known, a larger brain than the queen. In the drone the optic lobes are large, corresponding to the large

* U.S. Nat. Museum, Bull. 68 (1909) xii. and 258 pp. (30 pls.).

† Zool. Jahrb., xxviii. (1909) pp. 325-86 (4 pls. and 9 figs.).

‡ Anat. Anzeig., xxxiv. (1909) pp. 337-49 (7 figs.).

§ Zeitschr. wiss. Zool., xcii. (1909) pp. 187-209 (1 pl. and 9 figs.).

|| Jenaische Zeitschr. Natur., xlv. (1909) pp. 111-80 (5 pls. and 13 figs.).

eyes, but the brain proper is not larger than that of the worker. The author has devoted much attention to the two "mushroom-shaped bodies"—parts of the brain—which reach their climax in Hymenoptera. They seem to be organs for the combination of various sensory impressions, and probably for the acquired associations.

Parasitic Hymenoptera from the Tertiary of Florissant.*—C. T. Brues describes no fewer than 112 clearly defined species of fossil Hymenopterous insects from Florissant, Colorado. The wings are usually well preserved, lying between the laminae of the shale, and the preservation of the colour is often remarkable. Most of the species are Ichneumonidae, but Chalcidoidea and Braconidae are well represented.

Viviparity in *Phorocera serriventris* and other Flies.†—W. Wesché notes that this Tachinid fly is viviparous, the living larvæ being introduced by the "ovipositor" into caterpillars. By means of the Microscope it is possible to detect the viviparous condition of flies, if the specimens are properly cleaned and prepared, as the hard chitinous jaws of the larvæ are not dissolved by potash, and are seen through the cleared plates. Wesché has observed this not only in *Phorocera serriventris*, but in *Oliviera lateralis* F., *Plagia trepida* Mg., *Phora ruficornis* Mg., *Myiobia fenestrata* Mg., *Siphona geniculata* Deg., *Blepharidea vulgaris* Fln.

Gossyparia ulmi on Mistletoe.‡—L. Fulmek found on the mistletoe (in Wachau) full-grown females of the Coccid *Gossyparia ulmi*, which is usually found on elm-trees.

Tobacco Beetles.§—J. P. Wright has a note on beetles from Turkish tobacco-leaf, which apparently "thrive" in naphthalin. Bisulphide of carbon effectually disposes of them.

Palæarctic Spongostylinae.||—P. Sack gives an account of this family of Bombyliidae, which includes a number of sun-loving forms, with a tuft of hair at the tip of the antennæ, such as *Anthrax virgo* Egger, *Bibio hesperus* Rossi, and *Spongostylum mystaceum* Macq. The author makes eight new genera.

Odoriferous Organs in Female Lepidoptera.¶—H. H. Freiling describes (1) odoriferous organs on the wings of both sexes in *Adopæa lineola*, *Acipitilia pentadactyla*, *Notris verbascella*; (2) sensory organs on the wings of *N. verbascella*; (3) odoriferous organs (modified scales or setæ) near the external genital organs in females of *Gonopteryx rhamni* and *Euplæa asela*, *Stilpnotia saliris*, and *Thaumatopeæ pinivora*; (4) integumentary duplicatures between the 8th and 9th abdominal segment, modified as odoriferous structures—a dorsal fold in the female of *Orgyia antiqua* and lateral sacculi in the female of *Bombyx mori*; and (5) evaginable odoriferous brushes lying dorsally between the 7th and 8th segments in the males of *Euplæa asela* and *Danaïa septentrionalis*.

* Bull. Mus. Harvard Comp. Zool., liv. (1910) pp. 1-125 (1 pl.).

† Journ. Quekett Micr. Club, 1909, pp. 451-8 (1 pl.).

‡ Centralbl. Bakt. Parasitenk., 2te Abt., xxiv. (1909) pp. 106-8 (3 figs.).

§ Journ. Quekett Micr. Club, 1909, p. 472.

|| Abh. Senck. Nat. Ges., xxx. (1909) pp. 503-48 (4 pls.).

¶ Zeitschr. wiss. Zool., xcii. (1909) pp. 210-90 (6 pls. and 17 figs.).

Oogenesis in *Dytiscus marginalis*.*—P. Debaisieux finds that four differential kinesis succeed the oogonial kinesis and give rise to an oocyte with fifteen nutritive cells. The "chromatic mass," which appears at the first of the four differential kinesis, is transmitted intact to the oocyte. After the last differential division there is a true synapsis, before "the great increase of the oocyte." The behaviour of the chromosomes is fully described.

Luminosity of Glow-worm.†—Fr. Weitlaner finds no warrant for regarding the luminescence of *Lampyrus splendidula* as bacterial. It is an oxidation phenomenon, occurring mainly in the grains of ammoniacal uric acid and diffused through the body, and in both sexes. Occasionally the luminosity is absent in both sexes.

Life-history of Agrionid Dragon-fly.‡—F. Balfour-Browne deals especially with *Agrion pulchellum* and *Ischnura elegans*. While a pair fly about or rest, attached per collem, the female curves her abdomen so as to bring the underside of her 9th segment in contact with that of the 2nd abdominal segment of the male. Soon after the transference of sperms the female begins to lay, the male usually holding her, though remaining entirely passive. The observer followed *Agrion* and *Ischnura* right through from the egg to the imago, and describes the stages marked by the successive moults. He discusses the development of the form of the nymph, and pays special attention to the pro-nymph stage. This stage is apparently for the purpose of freeing a tightly-packed larva from the egg. The amnion, instead of breaking and remaining within the shell, continues intact until after the larva is clear. The amnion forms the pro-nymph skin.

The fact that certain moults have nothing whatever to do with growth (e.g. of the pro-nymph) seems fatal to a theory that growth is the cause of moult; while the fact that certain moults have apparently nothing to do with development, seems fatal to a theory that makes development the cause of the moult. Since, however, both causes seem to be at work, it is possible that both theories, combined and readjusted, may give us a true explanation of the significance of the moult.

Irish Neuroptera.§—J. J. F. X. King and J. N. Halbert have made a new list of the Neuroptera of Ireland, including 240 species, in 105 genera—rather less than two-thirds of the number recorded for Great Britain. They have added eight species of Planipennia (alder-flies, etc.), eleven species of Trichoptera (caddis-flies), and some others. The nomenclature has been brought up to date, and emphasis is laid on cases of interesting geographical distribution.

Development of Endoderm in Mole-cricket.||—J. Nusbaum and B. Fnlinski have traced the development of the mid-gut in *Gryllotalpa vulgaris*, and compared this case with others. In the anterior region of the blastoderm the primordium of the endoderm and, immediately in

* La Cellule, xxv. (1909) pp. 207-29 (2 pls.).

† Verh. Zool. Bot. Ges. Wien, lix. (1909) pp. 97-103.

‡ Proc. Zool. Soc., 1909, pp. 253-85 (2 pls.).

§ Proc. R. Irish Acad., xxviii. Section B (1910) pp. 29-112.

|| Zeitschr. wiss. Zool., xciii. (1909) pp. 306-48 (2 pls. and 11 figs.).

front of it, the stomodæal invagination arise simultaneously. In the posterior region the primordium of the endoderm arises slightly before the appearance of the proctodæal invagination. There soon comes about a coalescence of the endoderm-primodia with the stomodæum and the proctodæum. The authors make an interesting series of seven different ways in which the mid-gut epithelium is established in Pterygota.

Studies on Aphides.*—Albert Tullgren discusses the sub-family Pemphiginae and its various tribes—Vacunina, Hormaphidina, Mindarina, Pemphigina, Schizoneurina, Anœciina.

New Genera of Thysanoptera.†—R. S. Bagnall describes two large and interesting forms from Venezuela—*Anactinothrips meinerti* g. et sp. n., in the Phlœothripid group, and *Actinothrips longicornis* g. et sp. n., in the Idolothripid group of the Tubilifera. The author calls attention to an organ, or set of organs, first discovered by Tryborn, which apparently exists in all Thysanoptera, and is found at the base of the femur near the line of union with the trochanter, taking the form of a thinly chitinised area, or areas, of varying shapes.

Injurious Insects.‡—The oyster-shell bark-scale (*Aspidiotus ostreeformis*) which is injurious to various fruit-trees in Britain, and the brown scale of the gooseberry and currant (*Lecanium persicæ* var. *ribis*), are the subject of two recent leaflets from the Board of Agriculture.

Ectoparasites and Endoparasites of Grouse.§—A. E. Shipley begins with the Mallophaga (*Goniodes tetraonis* Denny, *Nirmus cameratus* Nitzsch), the Hippoboscid grouse-fly (*Ornithomyia lagopodis* Sharp), and two fleas (*Ceratophyllus gallinulæ* Dale and *C. garei* Rothsch.). A fly, *Scatophaga stercoraria*, which lays its eggs in grouse-droppings, is also discussed. The following Acarina were studied: *Ixodes ricinus* L., *Aleurobius farinæ* de Geer, and *Gamasus coleopratorum* L.

Three species of tapeworm (two of *Davainea* and one of *Hymenolepis*) are found in the alimentary canal, and the question is as to their previous host. A slug (*Arion empiricorum*) found in the crop was sectioned without showing any cysts. Various Copepods in the moor streams were tried without result. It is probable that some insect is the source of infection. Artificially-reared grouse showed no *Davainea* nor *Hymenolepis*; and another notable fact is that grouse three weeks old often contain fully grown *Davainea*, which shows infection must be very early. Attention is directed to moth-larvæ which occur in rushes. Many remains of insects were found in the grouse, though sportsmen and game-keepers usually maintain that the bird eats no insects.

B. Myriopoda.

Abnormal Pair of Limbs in Lithobius.—F. G. Sinclair || refers to a case described by Doncaster, and gives it a different interpretation. The abnormalities in Myriopods may be reduplications in the transverse

* Arkiv Zool., v. (1909) pp. 1-190 (92 figs.).

† Journ. Linn. Soc. (Zool.) xxx. (1909) pp. 329-35 (1 pl.).

‡ Board of Agriculture and Fisheries, Leaflets No. 210 and 223 (1909) 8 pp. (6 figs.).

§ Proc. Zool. Soc., 1909, pp. 309-34 (13 pls.).

|| Proc. Cambridge Phil. Soc., xv. (1909) p. 235.

axis (e.g. a bifurcating leg), or reduplications in the longitudinal axis. The former is the more frequent. The abnormal appendage described by Doncaster is probably a reduplication, not of the poison-claw, but of the second maxilla.

Classification of Geophilomorpha.*—H. W. Brölemann discusses the classification proposed by Verhoeff, and compares it with that suggested by Attems and by himself. He also gives diagnoses of some new genera—*Trematorya*, *Ribautia*, *Gnathoribautia*, *Alloschizotenia*, *Brachygeophilus*, and *Chalandea*.

Studies on Diplopoda.†—F. Silvestri describes *Pericambala orientalis* g. et sp. n. from Tonkin, and erects for it a new family Pericambalidæ in Cambaloid section of Diplopoda.

δ. Arachnida.

Development of Agelena labyrinthica.‡—G. Kautzsch begins with the formation of the polar bodies and the segmentation of the eggs; he follows the stages in the differentiation of the blastoderm—the appearance of cumuli and of metameres; he discusses the remarkable process of “Umrollung” exhibited by the germinal streak, the origin of the heart and the blood-cells, and the difficult question of the “endoderm”—a term which does not seem to have much meaning (in a comparative embryology sense) in the development of Arachnoids.

Structure and Habits of Ixodes ricinus.§—Katharina Samson gives a valuable account of this tick, describing the various systems of the body and the reproduction. Many new points of interest are discussed.

ε. Crustacea.

Hippolyte gracilis in the British Area.||—A. O. Walker records this Mediterranean species from Worthing, where he found it associated with *H. varians*. This is the first record for the British area proper. In 1899 Walker reported a specimen taken by Hornell in the Channel Islands.

Anomura of Kattiawar.¶—T. Southwell reports on a small collection of Anomura from Okhamandal in Kattiawar, including *Porcelana gäekwari* sp. n. and *Polyonyx hendersoni* sp. n. The collection is interesting in showing the considerable degree of variation present in certain species of the family Galatheidæ, and secondly, the large size of many individuals, which shows the luxuriant conditions under which they must have lived.

New Species of Pinnoteres.**—J. Hornell and T. Southwell describe *P. placunæ* sp. n. abundant in the window-pane oyster (*Placuna placenta*). It is characterised by being extremely flattened dorso-

* Arch. Zool. Expér., iii. (1903) pp. 303-40 (1 table).

† Boll. Lab. Zool. Scuola Agric. Portici, iv. (1909) pp. 66-70 (5 figs.).

‡ Zool. Jahrb., xxviii. (1903) pp. 477-538 (3 pl. and 25 figs.).

§ Zeitschr. wiss. Zool., xciii. (1909) pp. 185-236 (4 pls. and 18 figs.).

|| Ann. Nat. Hist., v. (1910) p. 216.

¶ Report to Govt. Baroda Marine Zool. Okhamandal in Kattiawar, 1903, pp. 105-23 (1 pl.).

** Tom. cit., pp. 99-103 (1 pl.).

ventrally (in adaptation to the habitat), by having the front of the carapace straight and broad in the female, and by the approximately square outline of the carapace. The other extreme is *P. globosus*.

Digestive System of Schizopods.*—Charles Gelderd has studied *Macromysis flexuosa* and related forms. The fore-gut has the same general structure as that of Decapoda and Edriophthalmia, and contains similar pieces. These are dealt with in detail. The author describes the acinous "salivary glands," the hepatopancreas, and the structure of the gut generally. In each long tube of the digestive gland there is an irregular longitudinal ridge projecting into the lumen. It seems to be characteristic of Schizopods.

New Copepod from an Ascidian.†—E. Chatton and E. Brément describe the female of *Enteropsis roscoffensis* sp. n. found in *Styelopsis grossularia*. The pereopods i.-iv. are uniramous; the antennæ are vaguely two-jointed, the last joint dagger-like; in these and other respects it differs from related species.

Annulata.

Albuminoid Reserves in Annelids.‡—Max Kollmann describes peculiar adipose cells in the perivisceral fluid of *Spirographis* and other Polychæts. They contain, besides fat, numerous granules of albuminoid substance, more or less acidophilous. They probably develop from leucocytes, and they bear a close resemblance to the adipose cells in insects. It is highly probable that they are of the nature of reserves.

Musculature of Owenia.§—Leo Zürcher has made a histological study of the musculature in this Chaetopod. In the body-wall he describes (1) the external epithelium; (2) a connective tissue limiting membrane (circular musculature in the thorax); (3) longitudinal musculature, composed of elongated pointed cells, differentiated into medullary space and contractile cortex with spirally disposed fibril-columns; and (4) a glandular peritoneum.

The blood-vessels have a connective-tissue intima and a circular muscular layer. The sinus between the intestinal epithelium and the circular muscle layer is lined with connective-tissue membranes. The peritoneum of the splanchnopleure is epithelial in two places—on the musculature of the vascular membrane in front of the second septum, and on the neural mesentery in the genital region. Elsewhere it is reduced to a few nuclei, apposed to the muscular layer. The vesicular connective-tissue is not a peritoneum, but an aggregate of degenerate lymphocytes.

Pelagic Phyllodocidæ of Irish Coasts.||—R. Southern describes some members of the sub-family Lopadorhynchidæ, collected at considerable depth off the west coast of Ireland. No species of this small and imperfectly known group has hitherto been recorded from the British

* La Cellule, xxv. (1909) pp. 7-70 (4 pls.).

† Bull. Soc. Zool. France, xxxiv. (1909) pp. 196-203 (5 figs.).

‡ Tom. cit., pp. 149-55 (3 figs.).

§ Jenaische Zeitschr. Naturwiss., xlv. (1909) pp. 181-220 (6 pls. and 4 figs.).

|| Sci. Invest. Fisheries, Ireland, iii. (1903) published 1909, pp. 1-11 (3 pls.)

marine area—a fact which is easily accounted for by the rarity and inaccessibility of the members composing it. He deals with *Pelagobia longecirrata* Greef, *P. serrata* sp. n., *Maupasia cæca* Vignier var. *atlantica* n., *Haliplanes magna* sp. n., *Lopadorhynchus appendiculatus* sp. n.

Primitive Germ-cells in Sagitta.*—W. Elpatiewsky finds that one of the blastomeres arising from the fifth cleavage is the first primitive germ-cell. It is marked by a particular body—taking on nuclear stains—which is seen in all the germ-cell lineage.

New Leeches from Ceylon.†—W. A. Harding describes *Ozobranchus shipleyi* sp. n., in which the abdominal region bears eleven pairs of digitate branchiæ, and *Glossiphonia ceylanica* sp. n. The former is parasitic on the terrapin *Nicoria trijuga*, the latter on the soft tortoise, *Emyda vittata*.

Nematohelminthes.

Nervous System of Ascaris.‡—R. Goldschmidt continues his intimate analysis of the nervous system of *Ascaris megalocephala* and *A. lumbricoides*. He deals with the nerve-ring and the mode of union among its components, attaching numbers to the various cells and fibres, so that their connections are clearly seen in the diagrammatic reconstructions. He also discusses the general problems of continuity or contiguity of elements, of the neuron, and of the reflex arc, and ends up with a comparative morphological sketch of various nervous systems. His three schematic plates of the Ascarid system are very remarkable achievements.

Fibrillar Structures in Muscle-cells and Intestinal Cells of Ascarids.§—Fr. Bilek has studied in *Ascaris canis* and *A. semiteres*, and other forms, the peculiar fibrils in the muscle-cells and intestinal cells which have been called “neurofibrils,” “spongioplasm,” “supporting fibrils,” and a “chromidial apparatus.” The muscle-cells are gigantic; the thin gelatinous sarcoplasm requires some support in its contraction and dilatation. The fibrils form a kind of internal scaffolding. In the gut-cells they are not only supporting elements, but they replace the absent muscularis. The fibrils are essentially sarcoplasmic, not nuclear, and their interpretation as chromidial is erroneous.

Subcuticula and Lateral Areas of Nematodes.||—E. Martini has made an exhaustive study of sixteen types. Apart from the tail-end, behind the muscles, where there are no longitudinal lines, the subcuticula is without nuclei. These occur only in the inturnings of the subcuticula, which are called longitudinal lines. In the trunk the dorsal line is without nuclei. The ventral line shows some nuclei. There are usually three rows of nuclei in the lateral area, and they may be very numerous. Nuclei are never absent from the lateral line. In the head, all the four main longitudinal lines show nuclei, and the tissue of the lines extending inwards forms a support for the nerve-ring and nerve-centres.

A more general statement may be useful. The epidermis of Nema-

* Anat. Anzeig., xxxv. (1909) pp. 226-39 (19 figs.).

† Proc. Cambridge Phil. Soc., xv. (1909) pp. 233-4.

‡ Zeitschr. wiss. Zool., xcii. (1909) pp. 306-57 (3 pls. and 21 figs.).

§ Op. cit., xciii. (1909) pp. 625-67 (2 pls.).

|| Tom. cit., pp. 535-624 (2 pls. and 21 figs.).

todes, which covers the whole body outside the muscles, is well developed only in the so-called longitudinal lines, especially in the lateral areas. Between the lines (subcuticula) it is very thin. By the development of the muscles, the nuclei of the epidermis come to lie in the longitudinal lines, especially in the lateral lines. The epidermis makes the cuticle repeatedly in the course of life.

Nematodes of Red Grouse.*—A. E. Shipley reports on the following:—*Trichostrongylus pergracilis* Cobbold, *Syngamus trachealis* (which occurred twice), *Trichosoma longicolle* Rud., *Heterakis papillosa* Block, and *Filaria smithii* Sambon.

Platyhelminthes.

New Planarians.†—P. Steinmann gives a full description of *Planaria teratophila* Steinmann, pointing out how it differs from *P. alpina*, *P. montenigrina*, and *P. anophthalma*, e.g. in the presence of two vesicular tentacular sense-organs; in the differentiation of the glandular zones on the pharynx into cyanophilous and erythrophilous; in the independence of the posterior cerebral hemisphere, and in some details of the male genital organs. He also discusses *P. lactea* Oerst. var. *bathycola* var. n., and *P. infernalis* Steinmann.

Paravortex cardii.‡—P. Hallez gives an account of the structure, habits, and development of *Paravortex cardii* sp. n., a Rhabdocœl parasite of the cockle. It reproduces viviparously throughout the year. It is a protandrous hermaphrodite, but the male organs continue to function throughout life. The empty shells, more than eighty in number, remain in the body, while the embryos bore out of the parent into the alimentary canal of the host, first the stomach and then the intestine. They pass out by the siphon. Copulation occurs in the intestine, perhaps also in the free-living stage. Thereafter there is migration into the stomach of a cockle, where the life is completed.

The segmentation is rather irregular, in a general way epibolic. A morula is formed, and all the elements seem to be of equal value. Hallez refrains from speaking of germinal layers. The ectolecithal nuclei share in development. The development proceeds like that of a bud, or like a neoformation after histolysis. A careful account of the whole process is given.

Synopsis in Thysanozoon brocchi.§—Willy Deton describes the resting nuclear reticulum that is re-established after the last "gonial" kinesis. The great increase in the size of the oocyte is preceded by a synaptic stage. This Turbellarian must be added to the list of those forms (e.g. *Planaria gonocephala*) in which there is a pseudo-reduction by means of a "zygotænic" stage.

Relationships of Digenic Trematodes.||—D. H. Ssnitzin lays emphasis on the absence of asexual multiplication in digenic Trematodes,

* Proc. Zool. Soc., 1909, pp. 335-50 (8 pls.).

† Zeitschr. wiss. Zool., xciii. (1909) pp. 157-84 (1 pl. and 3 figs.).

‡ Arch. Zool. Exper., ix. (1909) pp. 429-544 (10 pls.).

§ La Cellule, xxv. (1909) pp. 133-47 (1 pl.)

|| Biol. Centralbl. xxix. (1909) pp. 664-82 (1 pl.).

either in the form of division or budding. He goes so far that he would exclude them from the class. Their relationship with Turbellaria and Cestoda is very dubious; their resemblance to monogenic Trematodes is quite superficial. "The ancestor of the digenic Trematodes possessed a secondary coelom (gonocoel), and must be sought for among the nearest ancestors of the lower Crustaceans."

Abnormalities in Bothriocephalus.*—N. Leon describes two specimens of *Bothriocephalus latus*, which were in many ways peculiar. The colour was slate-grey, perhaps due to the bile. There were numerous supernumerary triangular joints, incomplete divisions of joints, curious irregular excrescences, and disk-like scales with short stalks. The scales are formed by evaginations of the cuticle and sub-cuticle. The prodigious multiplication of joints expresses a tendency to multiplication of the gonads.

Structure of Tetrabothrius.†—W. Spätlich describes two new species from *Puffinus*, and discusses the general structure of this Cestode type. The strongly developed longitudinal musculature is not interrupted at the boundaries of the joints. The musculature is very complex in the proglottides, and that of the scolex is derivable from it. The peculiar adhesive bothridia are described in detail. There are ten longitudinal nerve-strands, with three annular commissures in each joint, and centralisation in the head by means of a nerve-ring with four ganglia. Ganglion-cells were found in the head only. The anterior part of the head is without flame-cells. Not a few features in the *Tetrabothrius*-type confirm the interpretation of the Cestode body as that of one individual.

Posterior End of Rhynchobothrius Chain.‡—Th. Pintner has studied specimens of *Rhynchobothrius ruficollis* Eysenhardt, which retain the original terminal proglottis, showing a retort-shaped bladder with which the excretory vessels are connected. This bladder arises as an invagination of the outer layers of the body, with a special thickening of the circular muscle. It may be inferred that the original state of affairs at the end of a *Tetrarhynchus*-chain included a bell-shaped invagination around a central papilla, or that the original hind-end showed a protruding annular fold, the posterior half of the cavity forming a bladder; while in the anterior part the original external surface of the tail-end and the internal surface of the fold have coalesced up to the four excretory canals.

Tapeworms of Red Grouse.§—A. E. Shipley describes *Davainea urogalli* (Modeer), *D. cesticillus*, *Hymenolepis microps* (Diesing). Numerous insects have been searched in the hope of finding the cyst-stages of these tapeworms, but no result has as yet rewarded the author's labours.

Parasites of Birds allied to Grouse.||—A. E. Shipley gives a list of the Cestodes, Trematodes, Nematodes, and Acanthocephala known to occur in grouse, ptarmigan, willow grouse, hazel-hen, blackcock, and capercaillie.

* Centralbl. Bakt. Parasitenk., 1. (1909) pp. 616-19 (2 figs.).

† Zool. Jahrb., xxviii. (1909) pp. 539-94 (4 pls. and 9 figs.).

‡ Arb. Zool. Inst. Univ. Wien, xviii. (1910) pp. 113-32 (2 pls.).

§ Proc. Zool. Soc., 1909, pp. 351-63 (5 pls.).

|| Tom. cit., pp. 363-8.

Incertæ Sedis.

Regeneration in Enteropneusts.*—C. Dawydoff has studied this in *Ptychodera minuta* and in a New Guinea species. It appears that the regenerative processes pursue a somewhat palingenetic path. In some cases the regeneration is atavistic. But there is no fundamental difference between the ordinary ontogeny and the regenerative development. Dawydoff uses his results to throw light upon some morphological questions, e.g. the significance of the proboscis-cœlom and its relations to the pericardium. In regard to the so-called "notochord," he is of opinion that it corresponds to a pre-oral region of the gut, which previously functioned as a gullet. The proboscis pores of Enteropneusts represent an organ which has changed its function, and is homologous with the metanephridia of Annelids.

Studies in Tardigrada.†—Ferd. Richters describes several fresh-water species of *Makrobiotus*; a marine form, *Tetrakentron synaptæ* Cuénot, parasitic on *Synapta*; *Batillipes mirus* g. et sp. n., another marine type. Six marine genera are now known—*Lydella*, *Echiniscoides*, *Tetrakentron*, *Makrobiotus*, *Halechiniscus*, and *Batillipes*. Richters maintains that the Tardigrada are related rather to the Annelids than to the Arthropods, finding arguments in a seta-like nature of the "claws" in many types and in the cirri in others.

Rotifera.

Distribution of Rotifera.‡—C. F. Rousselet discusses the results of recent investigations with regard to the geographical distribution of Rotifera, and arrives at the conclusion that most of these creatures enjoy an almost cosmopolitan range all over the world, and that it is not possible to speak of any typical or peculiar Rotatorian fauna for any continent, zone, or region. Numerous examples are given of rare species appearing in widely separated localities, indicating that distance is no obstacle to their distribution, provided only that suitable conditions are encountered. The fact that some few Bdelloid Rotifers can come to life again after a prolonged desiccation does not sufficiently account for this wide range. The author considered that it is their resting eggs, which are able to resist both desiccation and low temperatures, and can moreover readily be transported by the wind to any distance, which are the main cause of this cosmopolitan distribution of the Rotifera from the equator to the polar regions.

Rotifera of Turkestan.§—E. von Daday has examined some Plankton material collected by D. D. Pedaschenko in two inland seas in Turkestan, and found therein amongst other creatures eleven species of Rotifera, one of which the author describes as new under the name of *Pedalion mucronatum*. This same species has, however, previously been found in the Aral Sea and described by Gernow in 1903 as *P. oxyure*, which name therefore has priority. It resembles most nearly *P. fennicum* Levander, but differs from it in the possession of a pointed posterior prolongation of the body.

* Zeitschr. wiss. Zool., xciii. (1909) pp. 237–305 (4 pls. and 23 figs.).

† Ber. Senck. Nat. Ges., xl. (1909) pp. 28–48 (2 pls.).

‡ Journ. Quekett Micr. Club, x. (1909) pp. 465–70.

§ Trav. Soc. Imp. Nat. St. Pétersbourg, xxxix. (1909).

Echinoderma.

Notes on North American Starfishes.*—A. E. Verrill calls attention to some apparent hybrids, e.g., between *Asterias epichlora* and *Pisaster ochraceus*. He also discusses multiplicity of rays, which is common on the north-west coast. Twelve of the forty north-west American species of *Asterias* and *Pisaster* have normally six rays. A number of interesting abnormalities are recorded, e.g., four-rayed forms of *Ctenodiscus crispatus*. The advantages of having numerous rays, e.g., for holding the food securely and holding to the rocks, are discussed.

Regeneration in *Ophiocoma pumila*.†—S. Morgulis finds that if the radial nerve is injured before cutting off the arm, only a small stump is regenerated. If the nerve is destroyed near the disc, so little new tissue is formed that it is difficult to recognise it at all. Where the radial nerve is left intact, a long new part is regenerated. In cases where the brittle star throws off the arm at the place of injury to the nerve, there is absolutely no regeneration from the cut surface thus produced, while other arms in the same specimen with the nerve intact regenerate normally.

Ophiurans of San Diego.‡—J. F. McClendon reports on a collection from this region, which includes some new species—of *Ophiomusium*, *Ophiura*, *Ophiopholis*, etc. “Although most of the species react negatively to light, and hide under rocks and in sea-weed, sponges, etc., some of them appear to protectively coloured.”

Mode of Feeding in *Echinocardium* and *Spatangus*.§—H. A. G. Hornyold finds that the buccal tube-feet are extended, feel about in the sand, broaden out terminally, seize a particle, and pass it to the spines of the lower lip. These with the assistance of the upper-lip spines pass the particles into the mouth. There is no shovelling of sand into the mouth by ploughing through it. Robertson of Millport described the action of the tube-feet and spines, and the author corroborates his observations in great part.

Development of *Holothuria floridana*.||—C. L. Edwards describes in particular the development of the tentacles, pedicels, and papillæ. There is no free Auricularia larva, but the embryonic stages are passed within the vitelline membrane during the first five days after the fertilisation of the egg. On the sixth day the embryo hatches as a larva with five primary tentacles, four developed (projecting) and one as a bud (buried in the skin), and also with one posterior pedicel. The order of appearance in subsequent stages is carefully chronicled.

Echinoderms of ‘Thetis’ Collection.¶—H. L. Clark reports on a collection of fifty-four species collected by the ‘Thetis’ from Lord

* Amer. Nat., xliii. (1909) pp. 542-55 (7 figs.).

† Proc. Amer. Acad. Arts Sci., xlv. (1909) pp. 655-9 (1 fig.).

‡ Univ. California Publications (Zoology) vi. (1909) pp. 33-64 (6 pls.).

§ Biol. Centralbl., xxix. (1909) pp. 759-62.

|| Journ. Morphol., xx. (1909) pp. 212-30 (3 pls.).

¶ Sci. Results Trawling Expedition H.M.O.S. ‘Thetis.’ Australian Museum, Sydney, Memoir iv. (1909) pp. 518-64 (12 pls.).

Howe Island and similar localities. The collection is of great scientific interest, not merely because eighteen of the species have not hitherto been described, but also because of the new light which it throws on the breeding habits of some species and the distribution of certain genera. A new genus of Ophinroids, named *Astorhombus*, has the disc covered by a very irregular, rough pavement of granules and plates of very diverse sizes, without any definite indication of radial shields.

Cœlentera.

Nervous System of Hydra.*—Jovan Hadži describes nerve-cells, processes of nerve-cells, sensory nerve-cells, and sensory cells. The greater part of the system is an ectodermic network. It is not appropriate to speak of neurons, for the cells are directly connected by plasmic processes, and *Hydra* is too far away from the type in reference to which the concept of neurons was established. The author has also studied the reactions of *Hydra* to contact stimuli, corroborating on the whole the results of previous investigators.

Oogenesis of Hydra.†—Elliot R. Downing gives an account based partly on his own observations and partly on those of others. In *H. diaccia* the ovaries are large and contain several ova; *H. viridis*, *H. fusca*, and *H. grisea* have one or very rarely two. The ovary is formed by rapid mitosis of interstitial cells beside the egg or eggs. There is no evidence of a migration of interstitial cells into the ovary. The interstitial cells form radiating rows to facilitate the transfer of nutritive material to the ova and to carry away the excretory products. The egg-cell is distinct from the interstitial cells from the start. The changes in shape, in granulation, in the size and structure of the nucleus, and so on, are described. The "pseudo-cells" are nuclei of ingested interstitial cells or are due to a confluence of small yolk-granules formed by the egg. When their formation is complete, the pseudopodia of the egg-cell are withdrawn. The first polar spindle has twelve chromosomes and the second six.

On the whole one is impressed, in a study of the ovogenesis of the *Hydra*, with the independence of the egg and its antagonism to the parent organism; it ingests portions of it as a parasite might live on a host. From the first the egg-cell pursues its destined life-history: it grows and matures, going through a definite cycle of events, dependent on the adult *Hydra* only for food. If constancy in the nucleo-plasma relation is characteristic of the life-cycle of the soma (and that seems very doubtful) it certainly is not for the germ-cells; on the contrary, continuous change seems to mark this relation in their life-cycle.

Budding and Shoot-formation of Hydroids.‡—Alfred Kuhn has made a fresh study of the hydroid colony. He shows that the mode of budding is much more diverse than is usually supposed. He illustrates convergence, e.g. in parallelisms between *Hydrallmania* and *Aglaophenia* types, and maintains that the selectionist interpretation is applicable to

* Arbeit. Zool. Inst. Univ. Wien, xvii. (1909) pp. 225-68 (2 pls. and 2 figs.).

† Zool. Jahrb., xxviii. (1909) pp. 296-324 (2 pls. and 2 figs.).

‡ Tom. cit., pp. 387-476 (6 pls. and 22 figs.).

some details at least. Evidence is given in support of the view that the Halecidæ diverged at an early stage from the Thecaphora stem which bears Campanularians and Sertularians, and that the Halecidæ lead on to the Plumularians.

Cnidoblasts of Hydra.*—O. Toppe finds that the large pyriform cnidoblasts with stilets on the nematocyst play the most important part in capturing prey. The nematocyst, helped by the stilets, perforates the cuticle of a *Cörethra* larva, and the secretion acts rapidly and destructively, forming a depression. There is no doubt that the nematocyst, partly by boring, partly by dissolving, can work through a chitinous membrane of considerable thickness. The large cnidoblasts work for the most part mechanically, and they seldom miss the mark. The nematocysts of the small cnidoblasts coil up in a corkscrew spiral after explosion, and they seem to respond to a different kind of stimulus. Thirdly, there are cylindrical cnidoblasts which aid in the attachment of the tentacles or the proboscis.

Medusoids, Medusæ, and Ctenophores of Firth of Forth.†—Wm. Evans and J. H. Ashworth record the following Hydromedusæ:—*Margelis britannica* Forbes, *Sarsia tubulosa* Sars, *Melicertidium octocostatum* Sars, *Tiaropsis multicirrata* Sars, *Mitrocomella polydiademata* Romanes, *Eutonina socialis* Hartlaub, *Tima bairdii* Johnston, *Æquorea norvegica* Browne. Of Scyphomedusæ they collected *Cyanea capillata* Linn., and *Aurelia aurita* Linn.; of Ctenophores, *Pleurobrachia pileus* Fab., *Bolina infundibulum* Fab., and *Beroë cucumis* Fab.

Nervous System of Anemones.‡—Paul Groselj has studied numerous Actinians—such as *Actinia equina*, *Cerianthus membranaceus*, *Adamsia palliata*, *Bunodes gemmaceus*—with respect to the minute structure of the nervous system. He describes the sensory nerve-cells (both ectodermic and endodermic), the ganglion-cells, and the processes of both. Attention is directed to the incipient centralisation to be seen in the ectoderm of the gullet, where the nerve-fibre layer is strongly developed; the sensory nerve-cells are very abundant: their processes form a very intricate ramification; there is extraordinary abundance of tripolar and multipolar ganglion-cells, which are arranged in radial bands and form a rich plexus of processes.

Zoanthæ from Queensland and New Hebrides.§—Leonora J. Wilsmore describes *Zoanthus sandvicensis* sp. n., *Z. similis* sp. n., *Z. pigmentatus* sp. n., and *Gemmaria arenacea* sp. n. The abundance of yellow-brown pigment in *Z. pigmentatus* is very striking. At the same time, zooxanthellæ are as abundant as in *Z. sandvicensis* and *Z. similis*, in which there is very little pigment. It seems, therefore, that the relationship between zooxanthellæ and pigment-granules, in virtue of which they replace one another in the genus *Parazoanthus*, and in several families of Actinaria, does not exist in these species.

* Zool. Anzeig., xxxiii. (1909) pp. 798-805 (7 figs.).

† Proc. R. Phys. Soc., xvii. (1909) pp. 300-11 (1 fig.).

‡ Arbeit. Zool. Inst. Univ. Wien, xvii. (1909) pp. 269-308 (1 pl. and 22 figs.).

§ Journ. Linn. Soc., xxx. (1909) pp. 315-23 (3 pls.).

Growth-stages in Parasmilia.*—W. D. Lang has studied the growth-stages in British species of this coral. The points touched on are these:—Hereditary growth-stages exhibited in rejuvenescence as evidence that the latter is a form of fission; views on the formation of dissepiments and tabulæ, and Bernard's ideas on these in connection with fission; their equal application to the colony and to the individual, and a suggested relation with histolysis; finally, comparison with other widely different groups of branching organisms—Plants and Polyzoa—so that laws of branching in one group may be compared with those in another, and any law common to all may be determined.

Observations on Living Alcyonarians.†—W. Kükenthal has studied living specimens of *Alcyonium adriaticum*, *Pteroëides griseum*, and *Eunicella verrucosa*. When colonies were placed in water bereft of its oxygen, they showed a more or less marked swelling up, which suggests that the intake of water is largely of respiratory significance. Colonies may be expanded for preserving purposes by placing them in water with little oxygen. The pores at the top of the shaft in *Pteroëides* serve for rapid expulsion of water.

Alcyonarians of Irish Coasts.‡—Jane Stephens reports on a collection of Alcyonarians from Irish waters. It includes *Sarcodictyon catenata* Forbes, *Alcyonium digitatum* Linn, *Anthomastus agaricus* Studer, *Eunephthya (Dura) rosea* (Kor. and Dan.), *Gymnosarca bathybius* Kent, *Cerallium johnsoni* Gray, *Ceratoisias grayi* Wright, *Acanella arbuscula* Johnson, *Chelidionis aurantiaca* Studer, *Caligorgia flabellum* (Ehrenberg), *Stachyodes versluysi* Hickson, *Clematissa robusta* (Wright and Studer), *A. muricata* Verrill, *Paramuricea atlantica*, *Callistephanus koreni* Wright and Studer, *Pennatulula aculeata* Kor. and Dan., *P. bellissima* Fowler, *Virgularia mirabilis* (O. F. Müller), *Protoptilum thomsoni* Kölliker, *Funiculina quadrangularis*, *Benthoptilum sertum* Verrill (a remarkably fine specimen), *Kophobelemnion stelliferum* Müller, *Umbellula encrinurus* (Linn) var. *ambigua* Marion.

New Species of Stachyodes.§—S. J. Hickson describes *Stachyodes versluysi* sp. n. from Irish waters, e.g., 77 miles west-north-west of Achill Head, 382 fathoms. Its closest affinities are with *S. dichotoma* and *S. stuleri*, from which it differs in the large number of zooids in each whorl and in the character of the cœnenchym spicules. It is probable that the specimens from the Bay of Biscay described by Ronle as *Calypterinus allmani* belongs to this species.

Indian Ocean Alcyonarians.||—J. Arthur Thomson and J. J. Simpson give an account of the Alcyonarians collected by the 'Investigator' in the littoral area, and W. D. Henderson is responsible for the treatment of the huge and difficult genus *Spongodes* or *Dendronephthya*. The collec-

* Proc. Zool. Soc. London, 1909, pp. 285-307 (19 figs.).

† Aus der Natur., v. (1909) pp. 321-8 (4 figs.).

‡ Sci. Invest. Fisheries Ireland, v. (1907) published 1909, pp. 1-28 (1 pl.).

§ Tom. cit., pp. 10-13.

|| An Account of the Alcyonarians collected by R.I.M.S.S. 'Investigator' in the Indian Ocean. II. The Alcyonarians of the Littoral Area. Printed by order of the Trustees of the Indian Museum, Calcutta, 1909, xviii. and 319 pp. (9 pls.).

tion includes 187 species (61 belonging to *Dendronephthya*); 108 are new, but 53 of these belong to *Dendronephthya*. Two new genera are established, *Dactylonephthya* appended to the Nephthyidæ, and *Parabelemnion* among the Veretillids. There is also a full description of *Studeriotis mirabilis* n. n. (= *Studeria mirabilis* Thomson), and *Cactogorgia* Simpson, two new and remarkable types previously reported. Perhaps the most interesting result of this memoir is the evidence that the genera *Studeriotis*, *Dactylonephthya*, and *Cactogorgia* are annectent types related to Alcyonids, Nephthyids, and Siphonogorgids.

Porifera.

New Family of Calcareous Sponges.*—R. W. Harold Row reports on Crossland's collection of *Calcarea* from the Sudanese Red Sea, which includes sixteen species, six new. The collection is extremely interesting, owing to its strikingly intermediate character between the faunas of the Mediterranean and Atlantic on the one hand, and of the Indian Ocean on the other. Of much interest is the author's account of a new type, *Grantilla*, which requires a new family, Grantillidæ. A dermal cortex is always present covering over the chamber layer. The skeleton includes sub-dermal "prochiacts" (modified triradiate spicules), and may or may not include sub-dermal sagittal triradiates and quadri-radiates. Subgastral prochiacts may or may not be present. Chambers and skeleton arrangement are as in the Grantidæ.

Another new genus, *Kebira*, is of unusual interest as a living member of the Pharetronidæ, an almost wholly fossil family, and in having peculiar triradiates, the paired rays of which are vestigial. The developed fibres, which look like oxeads, lie radially disposed, or inclined but little to the radial direction, in the chamber-layer. The canal system is leuconoid, with large sub-dermal cavities, inhalant and exhalant canals.

Hexactine Spicules.†—R. Kirkpatrick gives reasons for the following conclusions. The regular hexactine spicule (with three axes crossing at right angles through a common centre and corresponding with the axes of the regular crystalline system) was primarily formed in Hexactinellid sponges, as being the most economical and efficient means for supporting the strands of a syncytial network; for, in the gastrosome at any rate, the microscleres would be useless for upholding the body or flagellated chambers, but most efficient for the vitally important function of keeping open the meshes of the dermal network. The geometrical forms of cubes, squares, or lines (hexactins, stauractins, amphidiscs), arise in correspondence with the requirements for supporting cubical spaces, surfaces, or concentric laminae. The support of flagellated chambers and of the body as a whole was a later need, and was effected by the development of microscleres into parenchymal and auxiliary surface macroscleres. The identity of axes of the regular hexactin with those of the regular crystalline system is a coincidence, the real determining factor of the shape being a biological one.

* Journ. Linn. Soc. (Zool.) xxxi. (1909) pp. 182-214 (2 pls. and 8 figs.).

† Ann. Nat. Hist., iv. (1909) pp. 505-9.

Protozoa.

New Heliozoon.*—H. R. Hoogenraad describes *Frenzelina minima* sp. n. from fresh-water pools in Holland. He contrasts it with Penard's *F. reniformis* from the Lake of Geneva, and gives the following extended definition of the genus:—Shell hemispherical or more than hemispherical, slightly compressed antero-posteriorly and vertically, thin, glassy, transparent, more or less thickly covered with foreign particles; the plasma has an elliptical or kidney-like shape, with thread-like, often forked pseudopodia. The genus is readily distinguished by the shape of the shell from the nearly allied *Pseudodiffugia*.

Conjugation in Anoplophrya.†—B. Collin describes the details of the conjugation in *Anoplophrya branchiarum* Stein (= *A. circulans* Balbiani), the well-known astomatous parasite of the blood of *Gammarus pulex*. There are two micronuclear maturation mitoses, and a third division forms the pronuclei. The migration of one of the pronuclei in conjugation is described. A study of the behaviour of the macronuclei confirms the interesting observation of Schneider that there is an exchange of half of the macronuclei between the conjugates.

Notes on Suctorina.‡—B. Collin has some notes on *Dendrosomides paguri* Collin, pointing out that the vermiform individuals, produced by the tentaculate (trifurcate) types by external budding, can transform themselves into trifurcate types. The dimorphism is only apparent. In *Podophrya fixa* O. F. Müller there are two forms of encystation—for division and for rest. What has been called transverse division in *Podophrya* is budding, with a change of axis. Within the cyst, Collin observed what looked like division into two and then into four, but it is really budding. The products pass out as ciliated or tentaculate forms. A budding which looks deceptively like division occurs in parasitic forms of *Sphaerophrya*.

Life-cycle of Paramecium.§—L. L. Woodruff finds that the protoplasm of these organisms, when subjected to a comparatively constant culture medium, passes through long cyclical changes in vitality which finally result in the death of the organism. The protoplasm may be "rejuvenated" by suitable changes in the culture medium (stimuli) at critical points in the cycle, and thus be enabled to resume active reproduction for a longer period. The essential fact brought out by this study is that the protoplasm of the individual *Paramecium* isolated over two years ago to start the culture has had the potential to divide (so far) over one thousand two hundred and thirty times at an average rate of more than three divisions every two days, and the representatives of the untold millions of its progeny which are still in captivity give every indication of being in as normal physiological and morphological condition as their ancestor. This suggests that when the protoplasm is constantly subjected to a suitable varied environment the cycle may be greatly prolonged and probably entirely eliminated—the fluctuations in vitality not transcending the rhythm.

* Tijdschr. Nederland. Dierk. Ver., xi. (1909) pp. 61-70 (1 pl.).

† Arch. Zool. Expér., i. ser. 5 (1909) pp. 345-87 (2 pls. and 2 figs.).

‡ Comptes Rendus, cxlix. (1909) pp. 1407-8.

§ Biol. Bulletin, xvii. (1909) pp. 287-308 (5 figs.).

Skeleton of Peridiniids.*—C. A. Kofoid gives a detailed account of the structure of *Peridinium steini* Jörgensen. He discusses the nomenclature and gives a table showing the synonyms. He also gives an account of the skeleton in *Podolampas elegans*. It consists of two apical, one intercalary, six precingular, three postcingular, four antapical plates, and a ventral area in which four divisions are recognisable: instead of one apical, five precingular, three postcingular, and two antapicals and a longitudinal furrow plate as heretofore stated. The missing girdle is represented by a narrow band fused to the lower ends of the precingular plates. On the surface of this band which is in the place along which the transverse flagellum passes, is a very shallow furrow. The so-called girdle (Schütt) of *Blepharocysta striata* is in reality the band of three postcingular plates. The "comb-like furrow" of Stein is a band of peculiar alternating pores on the antapical plates. The pores are highly differentiated and are distributed with reference to the movement of fluids and plasma of the cell-body. The plates are united by oblique sutures with overlapping edges and denticles intercalated between the elements of the bands of striæ. These striæ represent differentiations in the substance of the wall rather than surface ridges.

Studies of Trypanosomes.†—N. H. Swellengrebel gives an account of the structure and division of *Trypanosoma gambiense* and *T. equinum*. He deals, for instance, with the achromatin axial filament running through the cell. It splits longitudinally in the division, and plays a role in nuclear division like that of the nucleolo-centrosome in *Euglena*. It is comparable to the axial rod in *Trichomastix* and *Trichomonas*.

Howard Crawley ‡ describes *Trypanosoma americanum* sp. n., which seems to be a common parasite in healthy American cattle. Its structural peculiarity is that the trophonucleus and kinetonucleus lie very close together. This peculiarity is shown by *T. transvaliense*, taken to be a variety of *T. theileri*, and, as well as can be made out from his figures, by the trypanosome found by Miyajima. If this last fact be so, then Miyajima is in error in his conclusion that his flagellate is a phase of *Piroplasma*. The fact that trypanosomes occur in cultures of blood from healthy cattle is decidedly against the theory that they are stages in the life-history of a Hæmosporidian.

Cryptobia and Trypanoplasma.§—Howard Crawley points out that Leidy used the term *Cryptobia* in 1846 for organisms which would now be referred to the genus *Trypanoplasma* Laveran and Mesnil. He afterwards abandoned the name because of its resemblance to *Cryptobium*, but according to the tyrannical rules of priority it must stand and replace *Trypanoplasma*.

Piroplasma of Hedgehog.||—W. L. Yakimoff describes *Piroplasma ninense* sp. n. from the blood of the hedgehog. Its intermediate host is the nymph of a tick, *Dermatocentor reticulatus*, the adult of which is the bearer of a *Piroplasma* in horses.

* Archiv Protistenk., xvi. (1909) pp. 25-61 (2 pls.).

† Tijdschr. Nederland. Dierk. Ver., xi. (1909) pp. 80-93 (1 pl.).

‡ Bureau Animal Industry, U.S. Dept. Agric., Bull. 119 (1909) pp. 21-31 (1 fig.).

§ Tom. cit., pp. 16-19 (1 fig.).

|| Centralbl. Bakt. Parasitenk., lii. (1909) pp. 472-7 (1 pl.).

Transition Types between Bodo and Trypanoplasma.*—A. Alexieff indicates that it is easy to arrange a series showing the morphological transition from *Bodo* Ehrenberg to *Trypanoplasma* Laveran and Mesnil.

Spirochæta pallida in Ova of Congenitally Syphilitic Child.† Jas. McIntosh reports a case in which the ovaries, along with the other organs, of a congenitally syphilitic child showed enormous numbers of *Spirochæta pallida* (= *Treponema pallidum*). This has been previously observed by Levaditi and Sauvage and by Bab. The spirochæta evidently passes upwards into the ovary by the connective-tissue stroma and invades the Graafian follicles, even entering the ovum. The majority of the invaded follicles showed no degenerative changes. The author concludes that it is no longer legitimate to deny the possibility of the passage of *S. pallida* directly through the ovum of a syphilised woman to her offspring.

Infection of Rabbits and Guinea-pigs with Syphilis.‡—Mario Truffi gives a circumstantial detailed account of the infection of both rabbits and guinea-pigs with syphilis. A cutaneous infection thus brought about gives rabbits absolute and lasting immunity.

Study of Sarcosporidia.§—L. v. Betegh gives an account of the structure of the sporozoites of *Sarcocystis tenella* Raill and *S. blanchardi* Doff. at different stages in their development.

Ichthyosporidian Disease in Sea Trout.||—Muriel Robertson describes a parasite causing fatal disease in sea trout. It is closely allied to, if not identical with, *Ichthyosporidium gasterophilum* from *Motella mustela* and *Liparis vulgaris*. The parasite had invaded practically all organs of the sea trout, but was most abundant in the muscles of the heart. M. Robertson found a similar or identical form in 1906 in a small flounder (*Pleuronectes ftesus*). She also reports another occurrence of what seems to be the same in the tissues of the haddock.

* C.R. Soc. Biol. Paris, lxxvii. (1909) pp. 649-51.

† Centralbl. Bakt. Parasitenk., li. (1903) pp. 11-13 (3 figs.).

‡ Op. cit., lii. (1909) pp. 555-65.

§ Tom. cit., pp. 566-73 (2 pls.).

|| Proc. Zool. Soc., 1909, pp. 399-402 (3 pls.).



BOTANY.

GENERAL,

Including the Anatomy and Physiology of Seed Plants.

Cytology,

including Cell Contents.

Chromosomes of *Asphodelus microcarpus*.*—A. Maige has studied the formation of the heterotype chromosomes in *Asphodelus microcarpus*, and finds no support for Overton's theory as to the existence of pro-chromosomes, nor for the theory of Gregory and Berghs of two spirems existing side by side. Neither in the prosynapsis stage nor in the synaptic stage is there any sign of such structures. The chromosome-formation at first led the author to favour Farmer's theory, but subsequent closer examination has induced him to believe that Strasburger and Gregory are correct in their descriptions and theory. One curious condition observed in the present type is the delay of the longitudinal splitting of the portions of the spirem.

Structure and Development.

Vegetative.

Gum-flow in Relation to Anatomy in Bromeliaceæ.†—K. Boresch has studied the flow of gum observed in connection with the Bromeliaceæ in order to discover in what way it is related to the anatomy. In over fifteen species the flow of gum is from the stem, the chief seat of formation being the parenchyma of the stem, more especially the cortex. In *Pitcairnia Roezlii* gum exudes from the lower part of the leaf. A significant fact in connection with the origin of the gum-cavities is the staining of their walls with ruthenium-red. In *Quesnelia roseo-marginata* the gum can be stained with iodine-green. The walls of the gum-cavities have remarkable thyllose-formations, which often fill the cavities themselves. Most gum-cavities are probably of lysigenous origin, but some appear to be schizogenous. The gum in the first instance is derived from the cell-membrane, but later on the cell-contents share in its formation. Gum-flow may be produced artificially, and when occurring naturally must be regarded as a pathological phenomenon, the cause of which is unknown. It appears to originate in a circular meristematic zone, which lies between the central cylinder and the cortex, and extends from the growing point down into the lower parts of the stem. The Bromeliaceæ appear to be related in this respect to those Monocotyledons having specialised cambial zones. Especially

* Comptes Rendus, cxlix. (1909) pp. 1084-86.

† SB. Akad. Wiss. Wien, cxviii. (1908) pp. 1033-80 (3 pls.).

remarkable in this instance are the extent and duration of this cambium. *Aechmea Pineliana* exhibits certain colour-reactions, showing that the cells contain some unknown chemical compounds in their parenchyma-cells.

Reproductive.

Flower-morphology and Embryology of *Datisca*.*—W. Himmelbauer has studied *Datisca cannabina* and finds that the whole inflorescence is a thyrsum; the individual parts of it, however, are more or less complete dichasia. The female flower has three inferior carpels and three superior perianth-leaves. The placentation is marginal-parietal. The seed usually contains one embryo-sac mother-cell, which divides once and then develops into the embryo-sac. The archegonium completely disappears from the embryo-sac. The flower must be fertilised and the pollen-tube pushes its way by the funicle through the micropyle to the egg-apparatus. The opinions enunciated concerning parthenogenesis in this plant appear to be due to misconception.

Embryology of Penæaceæ.†—E. L. Stephens has examined five species belonging to the genera *Sarcocolla*, *Penæa* and *Brachysiphon*, and records several interesting facts in connection with their embryology. The embryo-sac mother-cell arises in the sub-dermatogen layer, and when heterotypic division occurs it already consists of four to five cell-layers. It develops directly into the embryo-sac. A central vacuole gradually forms, and here the four nuclei collect. By division sixteen nuclei are formed which arrange themselves symmetrically in four groups, which give rise to four groups of cells. Three of these groups unite and ultimately give rise to the egg-apparatus and the antipodal cells. The four free nuclei remain in the centre of the cell, and later on unite with the second nucleus of the pollen-tube to form the secondary nucleus of the embryo-sac. Endosperm-formation starts directly the embryo begins to develop. Usually embryo-development begins in the upper cell-groups, but development from lateral cells has also been seen. Polyembryony has been observed, but no instance of parthenogenesis or apogamy.

Physiology.

Nutrition and Growth.

Utricularia.—P. von Luetzelburg has studied many species of *Utricularia*, and concludes that they are truly insectivorous, being able to digest the insects which they catch owing to the secretion of an enzyme and an acid. The hairs which entrap the insects secrete sugar and mucus, but have no digestive action. The bladders are all of similar structure, and the flap closes so tightly owing to the mucus present that no insects can possibly get out. The direction of growth is strongly influenced by heliotropism and geotropism. Winter-buds can be produced artificially at any time. By special culture, also, the inflorescence axis can be made to produce lateral branches and growing

* SB. Akad. Wiss. Wien, cxviii. (1908) pp. 91-113 (1 pl. and 4 figs.).

† Ann. Bot., xxiii. (1909) pp. 363-378 (2 pls.).

‡ Flora, c. (1909) pp. 145-212 (48 figs.).

points. *Utricularia vulgaris* and *U. neglecta* are unable to live out of water, but *U. Bremii*, *U. minor*, *U. ochroleuca* and *U. intermedia* can exist for a long time if carefully watered. *U. montana* is a true land form and has lost its plasticity. The species *U. cornuta*, *U. reniformis*, *U. Glückii*, *U. elephas*, *U. Herzogii*, *U. Menziesii* and *U. neottioïdes* show great difference in form and adaptability. It would appear that the formation of the bladders may be of use in classifying and identifying species. *U. neottioïdes* has bladders on the leaves of young plants, although the older plants have no bladders.

Irritability.

Chloroplast-movements.*—K. Linsbauer and E. Abranowicz have studied the movements of chloroplasts, especially in *Lemna trisulca* and *Funaria*. The conclusions formed are briefly as follows:—The movements of the chloroplasts of these two plants show many analogies with the streaming of protoplasm. Ether-water (1 p.c.) inhibits the movements normally exhibited when the plants are placed in darkness, while the assumption of the profile position due to direct insolation is facilitated. In positive apostrophe, however, etherised chloroplasts retain their position. Withdrawal of CO₂ is favourable to the taking up of the apostrophe position in direct sunlight, but is unfavourable to the change into the epistrophe position upon cessation of this light. Movement of the chloroplasts, unlike streaming of protoplasm, is connected with the power of assimilation. Increase in turgor favours the positive apostrophe. The collecting of chloroplasts in definite positions must be connected with phototaxis of the protoplasm. In *Funaria* the chloroplasts move along threads of protoplasm which are continually changing in form and position. Chloroplast movement is passive, although accompanied in some cases by an amœboid movement of the chloroplasts themselves.

General.

Systematic Relationship of *Sarracenia* and *Cephalotus*.†—J. Schweiger has studied the anatomy and morphology of *Sarracenia* and *Cephalotus*, and although he agrees with those authors who find a large number of similarities between the two genera, e.g. in the formation of the vascular bundles, the large number of tannin-cells and starch-grains, the structure of the glands, etc., he does not consider that there is sufficient ground for inferring a systematic relationship. The similarities appear to be of a biologic and not of a systematic character. The differences on the other hand balance the similarities in number and are of more weight in relation to systematic position. Thus, the flowers of the *Sarracenias* are pentamerous while those of *Cephalotus* are hexamerous. The structure of the stamens and of the pollen-grains is different for the two genera. Especially to be noticed is the difference in seed-development, that of *Sarracenia* being of the sympetalous type while the seed of *Cephalotus* is of the polypetalous type. In *Sarracenia* the

* SB. Akad. Wiss. Wien, cxviii. (1909) pp. 137-82 (2 pls. and 2 figs.).

† Beih. Bot. Centralbl., xxv. (1909) pp. 490-539 (58 figs.).

embryo-sac absorbs the entire nucellus, while in *Cephalotus* the ripe seed contains perisperm. *Cephalotus* has numerous seeds, while *Sarracenia* has only one. These and other differences appear to discredit any systematic relationship between the two genera.

Variation of *Zinnia* due to Traumatism.*—P. Becquerel contributes some interesting observations upon variations exhibited by *Zinnia elegans* in consequence of traumatism. The plants having been partially frost-bitten, the damaged portions were cut away. The remaining shoots produced very fine flowers, which showed some remarkable variations in the structure of the capitula, the colour and scales of the florets, and the grouping of the leaves upon the stem. The author is not prepared to assert that these phenomena have any connection with mutations, but he awaits the results of the seeds produced by these flowers, before making any definite statements.

Origin of Cultivated Oats.†—M. Trabut contributes a note upon cultivated oats. The writer has examined many species of North African oats, and finds that they are all to be regarded as secondary species of *Avena sterilis*. They differ in no important respect from the cultivated oats of the Mediterranean region, and they are not hybrids. It would appear that *A. sterilis* and *A. fatua* have given rise to two series of cultivated oats; the former is characteristic of the Mediterranean region, and has tough elongated glumules, the lower glumule inserted obliquely, and other less important characters; the latter is characteristic of central Europe, and has short glumules inserted horizontally, while the flowers separate by rupture from the rachis. The character of the articulations may be useful in determining spontaneous species, but should only be regarded as of secondary importance.

New Fossil Discoveries and their Significance.‡—H. Brockmann-Jerosch contributes a preliminary paper upon some new fossils discovered in the quaternary beds and their significance in reference to the flora of the Ice Age. Through excavations lately made in the neighbourhood of Güttenstall it has been proved that the geological strata in that region are less old than the slate-coal beds of Uznach. The present discoveries show that the Nathorst theory as to the *Dryas*-flora is not tenable, for everywhere that this flora has been examined, there has been found intermingled with it a flora characteristic of the climate of modern central Europe. This flora includes both water and land plants, such as *Sparganium*, *Potamogeton*, *Alisma*, *Salix repens*, *Betula*, *Ranunculus*, etc. This tends to show that we are dealing with a flora of warm, level regions. The author regards the *Dryas*-flora, not as a remnant of a general flora but as a zone surrounding an ice-region, and believes that the fossil discoveries cited in favour of the Nathorst theory have been wrongly classified as to their geological age, owing to misconceptions derived from the theory itself.

* Comptes Rendus, cxlix. (1909) pp. 1148-50.

† Tom. cit., pp. 227-9.

‡ Vierteljahrsh. Naturf. Gesell. Zurich, liv. (1909) pp. 101-15.

CRYPTOGAMS.

Pteridophyta.

(By A. GEPP, M.A., F.L.S.)

Fertile Spike of the Ophioglossaceæ.*—M. A. Chrysler discusses the nature of the fertile spike in the Ophioglossaceæ. He recapitulates the theories that have been put forward by previous authors, describes his own investigations, and gives the following summary. 1. The pair of vascular bundles in the fertile spike of *Botrychium virginianum* arise from near the edges of a trough-shaped and usually split leaf-trace. Each of these bundles leaves a gap in the leaf-trace. Similar gaps occur in other ferns. 2. Since the bundles running into the pinnae of the sterile frond arise in exactly in the same way, it is inferred that the fertile spike represents two fused basal pinnae. 3. In *B. ternatum* and *B. obliquum* there is a slight modification as to the gaps, which is regarded as a reduction of the condition found in *B. virginianum*. 4. In other species a further reduction is found, the gaps being absent. 5. Abnormal specimens of *B. obliquum* show either a pair of fertile spikes, or a pair of spikes with a single spike (fused pair) below. Such cases are regarded as reversions. 6. In *Ophioglossum* the bundles leading to the fertile spike break off from the two edges of the curved row of strands which represents the leaf-trace. This condition is regarded as derived from that of *Botrychium*. 7. In *Helminthostachys* the vascular supply of the fertile spike is derived principally from one edge of the curved row of bundles which forms the leaf-trace; and it is inferred that here the fertile spike represents a single pinna. 8. The Ophioglossaceæ are related to the ferns, having sprung from near the level of the Osmundaceæ. They branched off from the primitive stock at a very remote period. 9. A study of the internal structure of the leaf in Ophioglossaceæ affords strong support to Roeser's view that the fertile spike represents two fused basal pinnae, though in certain cases a spike represents a single pinna, which, however, does not rise ventrally. No support is afforded to the view of a strobilar origin or of a direct derivation from Hepaticæ.

Foliar Gaps in the Osmundaceæ.†—E. W. Sinnott discusses the presence of foliar gaps in the Osmundaceæ. 1. He examined six species, and found foliar gaps in all at the points where leaf-traces branch off from the vascular cylinder, though sometimes obscured. 2. All fossil Osmundaceæ with parenchymatous pith show foliar gaps. 3. All young Osmundaceæ, with a single doubtful exception, show foliar gaps from very early stages. 4. In seven species a gap in the arch-shaped leaf-bundle was always found at the base of the trace to the pinna. In three species this gap affected only the xylem, but in the remaining four involved a complete break in the vascular tissue. 5. That foliar gaps represent a primitive feature in the Osmundaceæ is quite clear from the fossil evidence and the structure of the young plant and the foliar strands (both of which are ever conservative of ancestral characters).

* Ann. Bot., xxiv. (1910) pp. 1-18 (2 pls. and figs.).

† Tom. cit., pp. 107-118 (2 pls.).

6. The Osmundaceæ are, therefore, very properly placed in Jeffrey's phylum *Pteropsida*, the members of which are primitively phyllosiphonic.

Chromosomes in Osmunda.*—S. Yamanouchi has studied the behaviour of chromosomes during both homotypic and heterotypic mitoses in *Osmunda cinnamomea*. He finds that :—1. The reticulum in the young nucleus arises from the chromosomes of the previous division by vacuolation, and consists chiefly of chromatin. 2. The chromatin network during the resting stage shows no indication of a pairing of knots or strands. 3. Individuality of the chromosomes is retained in the vacuolate and reticulate form during the resting stage, although the limits of individual chromosomes become hard to trace. 4. The pairing of chromatin material, perhaps of maternal and paternal derivation, appears only at the early prophase of heterotypic mitosis. The pairs may come into the closest association during synapsis, but the duality is maintained. As a consequence no actual fusion occurs. 5. There is no splitting of chromosomes in the heterotypic mitosis; each bivalent chromosome is formed by the association of two independent chromosomes. The separation of the two gives an appearance of longitudinal division.

Apospory and Apogamy in Trichomanes.†—P. Georgevitch publishes a preliminary note on apospory and apogamy in *Trichomanes Kaulfussii*, supplementing some observations by F. O. Bower. He describes the filamentous prothallium, its gemmæ and their further development into gametophytes bearing antherida and rhizoids. The transition from sporophyte to gametophyte is attended by no alteration in the number of chromosomes. The number of chromosomes is about eighty in both generations. As to the nucleoli, the number and appearance were the same in both generations. It is impossible to draw a sharp line of distinction between sporophyte and gametophyte. As in other plants, apospory implies absence of the meiotic phase.

Stegmata in the Hymenophyllaceæ.‡—M. Boubier describes the nature of the "stegmates" (*stegmata*, Deckzellen) discovered by Mettenius in 1864. They are cells of peculiar character found in the petiole or stem of some of the Hymenophyllaceæ, where they are applied to the outside of the fibrovascular bundles or to the stereids, and have their walls unequally thickened. The original cell-wall applied to the vessels is of pectose with a little cellulose; its strong internal secondary thickening is much lignified in some species, and mainly of pectose in other species. The middle part of the cell is occupied by a large crystalloid body which consists of a silicious capsule inclosing a mass of pectose strongly impregnated with silex. The author describes the reagents which he used for his microchemical examination.

Strobilus of Selaginella.§—G. Mitchell gives an account of the morphology of the strobilus of *Selaginella* with a view to completing the series of papers published by R. J. Harvey-Gibson upon the anatomy of

* Bot. Gaz., xlix. (1910) pp. 1-12 (pl.).

† Ann. Bot., xxiv. (1910) pp. 233-4 (fig.).

‡ Bull. Soc. Bot. Genève, ser. 2, i. (1909) pp. 281-4 (figs.).

§ Ann. Bot., xxiv. (1910) pp. 19-33 (2 pls.).

the genus. She describes the cone, the sporangia, imperfect sporangia, variation in the number of spores in the sporangium, detailed structure of the sporangium wall and mechanism for spore-shedding, the vascular system, and the ligule. She concludes as follows:—"The examination of the species serves to emphasize the intermediate position in which *Selaginella* stands. On the one hand, it may resort to conditions characteristic of the distinctly primitive Lycopodia, whilst on the other, its wonderful adaptations for cross-fertilization, bringing into play the most elaborate mechanism seen in the Pteridophyte group, and its near approach to the seed habit, render it one of the most interesting as well as instructive genera in the whole of the plant world."

Selaginella Preissiana.*—H. Bruchmann gives an account of *Selaginella Preissiana*, with a view to showing how far this peculiar species agrees in structure and arrangement of its organs with the other species which he has investigated. He describes the prothallium, the germinating plant, the mature plant, the apical growth arising from a group of apical cells, the branching, the stem, leaves, rhizophores, roots. The plant is strongly xerophilous, being well protected against loss of water by means of the conversion of its second dichotomous branch into a subterranean rhizome, and by means of the crowding of the shoots which soon produce fertile spikes and which have narrow lanceolate entire leaves, and also by means of the strongly cuticularised epidermis of shoots, rhizome, and rhizophores.

Origin of Heterospory in *Marsilia*.†—Ch. Shattuck discusses the origin of heterospory in *Marsilia*. He gives the following summary of his investigations. 1. The megaspores of *Marsilia* can be killed by a spray of cold water. They occur only in the oldest sporangia. The plant may then be put under good conditions to ripen sporocarps without megaspores. 2. The greatest variations occur when the megaspores and the oldest microspores are killed, and when strong plants develop a few sporocarps out of season. 3. When less than half the spores abort, enlargement does not appear among the microspores; the surviving spores are larger the greater the abortion. 4. The development of the mother-cells may be checked till the tapetal nuclei completely invest them. A perinium will then form around the mother-cell wall, investing the four young spores. The sporangium then invariably contains sixteen large forms each containing four nuclei. Or, if growth is less checked, the spores are more or less completely free and vary much in size and shape. 5. Among the young megaspores in a sporangium the contest for supremacy is very evident, several of them assuming considerable proportions, but one centrally placed invariably secures the ascendancy. The survivor sometimes retains the aborted members of its tetrad attached to its papilla. 6. The enlarged microspores vary in size up to 8 to 16 times the size of the ordinary ones, and the position of the nucleus changes from a central to an apical one (as in megaspores); and the vacuolation being more extensive, the shape of the nucleus varies from spherical to oval and finally to meniscus shape (as in megaspore).

* Flora, c. (1910) pp. 288-95 (figs.).

† Bot. Gaz., xlix. (1910) pp. 19-40 (4 pls. and fig.).

7. In extreme cases of abortion in the microsporangia only one spore survives, and grows to about 16 times the size of the normal microspore. The aborted tetrads remain as in the megasporangium, but are larger and better developed, indicating a more prolonged contest for supremacy. 8. In plants kept from sporocarp-formation until September 10, many microsporangia developed secondary megaspores, so called because they are formed after the first or primary ones. Such megaspores are intermediate in size and are also more nearly the spherical shape of the microspores. 9. In a few cases the megaspores did not develop a perinium, but enlarged considerably and became full of starch. 10. In normal plants, and in all cultures, a homosporous tendency is found, shown by the formation of microspores in the megasporangia, especially in those most distant from the nutritive supply. 11. *Marsilia* may be made to repeat, under culture, all the phases in the development of heterospory reported by Williamson and Scott for *Calamostachys Binneyana* and *C. Casheana*, and in addition to produce a megaspore of intermediate size.

Fertilisation of Fern-prothallia.*—G. Perrin gives a brief account of some experiments made upon fern-prothallia in order to test the applicability of Traube's theory that the rapidity of osmosis and the state of equilibrium dependent upon it is above all a function of the difference of the superficial tensions of the liquids present. Antherozoids of ferns in pure water with a superficial tension of 7.5 mg. move about without change of form or volume; but in solutions of lower superficial tension they move more slowly, swell, lose their form, and not rarely burst. Thus under the latter conditions fertilisation is fatally hindered. In the experiments described, solutions, with the surface-tension reduced by the addition of various infinitesimal amounts of bile-salts to pure water, were employed, and produced a corresponding reduction in the percentage of archegonia fertilised. Through swelling or bursting the antherozoids tend to fail to penetrate into the archegonia.

Cytology of Varietal and Hybrid Ferns.†—J. B. Farmer and L. Digby discuss the cytological features exhibited by certain varietal and hybrid ferns, and in particular *Polypodium Schneideri*, which is stated to be a hybrid between *P. aureum* and *P. vulgare* var. *elegantissimum*. In their summary they say that:—1. The view that *Polypodium Schneideri* is of hybrid origin receives support from a study of its cytology. 2. The nuclei of *P. aureum* are one-third smaller than those of *P. vulgare*. The number of chromosomes in *P. aureum* is about 34 to 36, in *P. vulgare* about 90. In *P. Schneideri* they vary between 95 and 125. 3. In *P. vulgare* var. *elegantissimum* many abortive spores are produced, in *P. Schneideri* all are abortive. This sterility is associated with degeneration of the cytoplasm and of the nuclear apparatus. 4. The achromatic spindle in *P. aureum*, etc., is bipolar, in *P. vulgare* mostly quadripolar, in *P. Schneideri* either bipolar or quadripolar, usually the latter. 5. The spindle is formed from a differentiation of the cytoplasm (kinoplasm) and is influenced in its distribution by the aggregation

* Comptes Rendus, cxlix. (1909) pp. 1086-7.

† Ann. Bot., xxiv. (1910) pp. 191-212 (3 pls.).

of the chromatin linin in the nucleus and by electrical conditions. 6. Chromatic droplets are ejected from the nucleus into the cytoplasm at certain stages of mitosis. 7. Nuclear divisions resembling amitosis occur frequently in the hybrid *P. Schneideri*, but they also occur rarely in *P. vulgare* and its var. *elegantissimum*. These imperfect mitoses are brought about by the failure of the nuclear wall to disappear at the end of diakinesis. 8. Much irregularity as to pairing of the chromosomes to form the bivalents exists in the hybrid plant, and also, though less obviously so, in *P. vulgare* var. *elegantissimum*. 9. The processes that lead to depauperation of the reproductive cells, and ultimately to sterility, in hybrids are encountered in certain sports, which also exhibit sterility in a marked degree.

Aspidium remotum Al. Br.*—H. Fischer discusses the question as to whether *Aspidium remotum* is the outcome of crossing or mutation. He collected specimens of the plant in the Vosges and raised plants from some of the spores. Some of the material germinated plentifully and the prothallia produced numerous plantlets, but they remained apogamous. The apogamy followed the usual lines and showed nothing of special interest; the upper part of the midrib, near to the apex, grew out into the young plant. The author comes to the conclusion that *Aspidium* (*Nephrodium*) *remotum* is certainly no good species, but also no monstrosity; the question remains whether it is a bastard or has arisen by mutation. The author inclines to the latter view. Whether apogamy is the general result of germination in *N. remotum* is also an unsolved question. Should further investigation prove that apogamy is typical for *N. remotum*, then the interesting fact is established that a bastard or a "mutante" has inherited apogamous methods of reproduction, such as we have only known till now in good species or monstrosities.

The author then discusses certain monstrosities (*N. filix-mas monstr. polydaetyla* Moore and *Athyrium filix femina monstr. depauperata* subvar. *Eitelstenii* Lowe) which he has grown under supervision, as well as some other species. He doubts whether *Asplenium germanicum* Weiss is really a bastard.

New French Ferns.†—H. Lévillé gives an account of two new varieties of French ferns described by H. Christ, *Polystichum* (*Dryopteris*) *filix-mas* var. *Pagesii* and *Asplenium foresiacum* var. *angustatum*, both collected in the department of Hérault by H. Coste.

Pteridophyta of Malta.‡—G. Gulia gives a list of the Pteridophyta of the Maltese islands. These comprise fourteen species, the distribution and native names of which are stated. *Salvinia natans* depends upon a single record, upon which Sommier casts some doubt in view of the absence of this species from all the Italian islands.

Studies of Tropical American Ferns.§—W. R. Maxon publishes a second paper on tropical American ferns, with the following chapters:—

* Ber. Deutsch. Bot. Gesell., xxvii. (1909) pp. 495-502.

† Bull. Acad. Internat. Géogr. Bot., xvii. (1909) pp. vii.-viii.

‡ Bull. Soc. Bot. Ital., 1909, pp. 220-2.

§ Contrib. U.S. Nat. Hist. Herb. Washington, xiii. (1909) pp. 1-43 (pls.).

1. Notes upon ferns recently collected in Guatemala, by Baron von Türckheim, with descriptions of thirteen new species. 2. The bipinnate species of *Cyathea* (one of the five species is new). 3. A revision of the West Indian species of *Polystichum*, with a key to the nineteen species (five of them are new). 4. Description of four new species.

American Species of *Dryopteris*.*—C. Christensen publishes a report on the American ferns of the group of *Dryopteris opposita* contained in the U.S. National Museum, including some 425 specimens, many collected by John Donnell Smith in Central America. Nine species are described as new; and in this and a preceding paper 94 American species of this one group have now been treated of by the author. The species of the Andes and West Indies have much affinity, while those of South Brazil show a remarkable difference. In the West Indies the continental element is strongest in Jamaica, where several species occur which are not found in the smaller islands. The geographical distribution of the species is displayed in tabular form.

Ferns of the Philippines.†—E. B. Copeland publishes a fourth article on new or interesting Philippine ferns, containing descriptions of seven new species and a new variety. *Currania* is a new genus, with one species, collected in the island of Luzon. It is probably derived from *Athyrium*, but is distinct in aspect and in various characters from every group in that genus, and its sori have no indusia.

Ferns of Costa Rica.‡—H. Christ publishes a sixth paper on the ferns of Costa Rica containing nearly fifty species, twenty-nine of which are new, including *Costaricia Werckleana*, the type of a new genus. This plant, though sterile, shows a sufficiency of characters to mark it out as a representative of a genus previously undescribed, but of uncertain position. Possibly it will eventually be found to have dimorphic fronds like a *Polybotrya*. Its habit resembles that of *Nephrolepis*. But from both these genera *Costaricia* is distinguished by various details. The specimens determined in this paper were collected by C. Werckle and C. Brade.

Ferns of New Guinea.§—H. Christ gives an account of the ferns brought back from New Guinea by the Dutch Scientific Expedition. They are seventy-three in number, and were collected mostly by G. M. Versteeg and a few by Bränderhorst: and they include eighteen new species and varieties.

Japanese Lycopodiales.||—H. Takeda gives a systematic account of the Lycopodiales of Hokkaido and of Japanese Sachalin, showing the synonymy, literature and distribution of each species and variety, and supplying some text-figures. The enumeration comprises 12 species, 8 varieties, and 2 forms of *Lycopodium*, 3 species of *Selaginella*, and 2 of *Isoetes*; and the detailed keys to the species are provided under each genus.

* Smithsonian Misc. Coll. Washington, lii. (1909) pp. 365-96.

† Philippine Journ. Sci. Manila, iv. (1909) pp. 111-15.

‡ Bull. Soc. Bot. Genève, ser. 2, i., pp. 216-36 (figs.).

§ Résult. Expéd. Sci. Néerlandaise à la Nouvelle-Guinée, viii. (1909) pp. 149-64.

|| Bot. Mag. Tokyo, xxiii. (1909) pp. 200-43 (figs.).

Japanese Ferns.*—T. Makino gives descriptions of the following Japanese ferns:—*Plagiogyria stenoptera* Diels, *P. Hayatana* (new species), *Monachosorum nipponicum* (new species), *Athyrium Nakanoi* (new species), *Blechnum nipponicum* Makino, *Polypodium Engleri* var. *yakushimense* (new variety); and supplies an analytical key to the Japanese species of *Plagiogyria*.

Structure and Position of Pinakodendron.†—R. Cambier and A. Renier publish some observations on *Pinakodendron*, of the three species of which little has been known hitherto. Being in possession of fine specimens of *P. Macconochiei* from Charleroi, they give a more complete account of the structure of the stem and branches, when it is concluded that *Pinakodendron* belongs to the Lepidodendreae as much as do *Asolanus* and *Bothrodendron*, the chief characters being found in the details of leaf-scars and the ornamentation of the bark. *Cyclostigma* has great affinity with *Pinakodendron*. *P. Macconochiei* appears to be specifically distinct from *P. musivum* and *P. Ohmanni*, but possibly the two latter are conspecific.

New Fossil Dadoxylon.‡—M. D. Zalessky gives a preliminary account of *Dadoxylon Trifilievi*, a new species found in the Upper Devonian of the Donetz basin in Russia. The medulla of its stem is surrounded by numerous bundles of primary xylem with mesarch structure and mostly contiguous to the secondary wood, which is of the *Dadoxylon* type. The author shows how the structure approaches *D. Spenceri* on the one hand and *Pitys antiqua* on the other.

Aloys Sodiro.§—Porter publishes an obituary notice of A. Sodiro, who died at Quito in June, 1909. A native of Italy, he acquired his early knowledge of plants in the southern countries of Europe. Going to Ecuador in 1870 he succeeded to the professorship at Quito held by W. Jameson. In studying the ferns and flowering plants of Ecuador he had great difficulties to contend against, amongst others, a lack of named specimens and of botanical books. He published several papers, the most important being his *Cryptogamæ Vasculares Quitenses*.||

Bryophyta.

(BY A. GEPP.)

Spermatogenesis of Mnium.¶—M. Wilson publishes a preliminary note on the spermatogenesis of *Mnium hornum*. He cites the statement of Arens and of Docters van Leeuwen-Reijnvaan, and points out wherein his own results differ from theirs, giving in brief many details concerning the nuclear changes observed during the development of the antheridium and spermatoocytes.

* Bot. Mag. Tokyo, xxiii. (1909) pp. 244-8.

† Comptes Rendus cxlix. (1909) pp. 1167-9.

‡ Bull. Acad. Imp. Sci. St. Pétersbourg, sér. 6, No. 18 (1909) pp. 1175-8.

§ Le Monde des Plantes, (1909) xi. pp. 47-48.

|| Quito (1893) 670 pp. (7 pls.).

¶ Ann. Bot., xxiv. (1910) p. 235.

Chemotaxis of Spermatozoids in Marchantia.*—Å. Åkerman gives an account of his investigations into the chemotaxis of the spermatozoids of *Marchantia*. The spermatozoids are attracted not only by proteid matters but also by salts of potassium, rubidium, and caesium. The spermatozoids become conscious of potassium salts and of proteid matters by different and independent acts of perception. Sodium and calcium salts have no such chemotactic action; on the other hand the salts of magnesium and ammonium exert a weak repulsion, and the salts of the heavy metals a strong one. As to the spermatozoids, all their movements of this character are of a chemotactic nature; they have no osmotic excitability; but, as Lidforss has shown, they manifest a clear aerotaxis.

Mechanism of Cohesion in Moss-leaves.†—W. Lorch continues his dispute with Steinbrinck about the mechanism of cohesion of *Polypodium* leaves. He is convinced that his opponent is wrong, and adduces fresh arguments to prove it by the peculiar behaviour of certain cells under polarised light.

Nomenclature of Sphagnum.‡—A. Le Roy Andrews criticises the proposals, which Röll will lay before the coming International Congress of Botanists at Brussels, concerning the nomenclature to be applied to *Sphagnum*. These proposals are broadly as follows. 1. *Sphagnum*-species are in their nature series of forms, and hence a type-form is an impossibility. Species based on a single form or specimen are of little value, and should give way to species described from a series of forms. 2. The description of a species (series of forms) should be short and characteristic, and should not repeat the characters of the genus, varieties, or forms. 3. Extension or completion of a description already existent does not justify change of specific name or change of author's name. 4. When within a genus a group is changed in rank or moved into another group without change of rank, the first author shall be cited, and the author for the change, if cited at all, be put in a parenthesis. Andrews regards Röll's proposals as founded on a fallacious idea of the species and types, as an offence against the principles of binomial nomenclature, as encouraging insufficient descriptions, and as generally reactionary.

British Bryophyta.§—C. B. Crampton records the occurrence of fruiting cushions of *Dicranum Bergeri* in Caithness, June 1908.

J. A. Wheldon || records the finding of the very rarely fruiting *Ulotophyllanthus* with abundant capsules, near Kingsbridge, in S. Devon, by H. Beesley in May 1909.

E. Armitage ¶ gives a list of nine mosses and four hepatics, new records for the vice-counties Elgin and Easternness, among them being *Ulotophyllanthus* with fruit. A new record for Ayr is added.

C. H. Waddell ** publishes a supplementary note on the late J. H. Davies and his connection with Thirsk and the mosses of Yorkshire.

* Zeitschr. f. Bot., ii. (1910) pp. 94-103.

† Ber. Deutsch. Bot. Gesell. xxvii. (1909) pp. 460-5.

‡ Bryologist, xiii. (1910) pp. 4-6.

§ Journ. of Bot., xlviii. (1910) p. 23.

|| Tom. cit., p. 57.

¶ Loc. cit.

** Loc. cit.

George Holmes,* of Stroud, Gloucestershire, is the subject of an obituary note. He died last October, aged 75, and for many years had been a keen and careful moss-student.

New and Rare European Mosses.†—G. Roth publishes descriptions and drawings of some twenty-three mosses, which are supplementary to those comprised in his book, "Europäische Laubmoose," published five years ago. Three of them are new to science, and the remaining species are rarities about which but little has been known hitherto.

Hepaticæ of Hamburg.‡—J. Schmidt publishes some new contributions to the study of the Hamburg flora, and among them gives a list of twenty-one hepaticæ with their local distribution and a few critical notes.

Mosses of the Rhöngebirge.—A. Geheeb has published a series of notes, nearly 100 in number, on the moss-flora of the Rhöngebirge, his native mountains. In the course of the last thirty years he had made numerous pedestrian tours in the district, and had acquired a great knowledge of the moss-flora. The notes are of a critical character, and are arranged in systematic order.

Mosses of Savoy.||—A. Guinet gives an account of some bryological excursions in the Alps of Annecy in Savoy—Mt. Veyrier and Roc de Chère. He enumerates 135 mosses, six Sphagnaceæ, and fifteen hepatics.

Bryophyta of Sicily.¶—L. Micheletti publishes a list of thirty-two mosses and two hepatics collected by himself and two others in Sicily, and adds an account of a moss which he found on the wall of an aqueduct near Messina in 1893, and which was named by Max Fleischer *Eucladium verticillatum* var. *Michelettii*.

North American Bryophyta.**—H. E. Greenwood gives a list of thirty-six hepatics collected at Worcester, Mass., where the swampy ground is favourable to the growth of the thalloid species; but the species proper to damp woodlands are disappearing.

I. Hagen †† publishes a note on the synonymy of *Hypnum ornithopodioides* Scop.

A. J. Grout †† publishes a fifth chapter of notes on Vermont bryophytes.

Bolivian Mosses.§§—T. Herzog publishes a contribution to the moss-flora of Bolivia, the proceeds of his visit to the provinces of Chiquitos and Velasco, to Cerro Amboró and Incacorral. He gives descriptions of three new genera, seventy new species, which he illustrates by means of plates and text-figures. He gathered also 322 species, additions to

* Journ. of Bot., xlviii. (1910) p. 64.

† Hedwigia, xlix. (1910) pp. 213-29 (2 pls.).

‡ Allgem. Bot. Zeitschr., xv. (1909) pp. 193-4.

§ Tom. cit., pp. 68-71, 90-2, 105-8, 135-7, 151-2, 171-3, 186-92.

|| Ann. Conserv. Jard. Bot. Genève, xiii. (1909) pp. 52-65.

¶ Bull. Soc. Bot. Ital., 1909, pp. 212-16. ** Bryologist, xiii. (1910) pp. 7-9.

†† Tom. cit., p. 9.

‡‡ Tom. cit., pp. 13-15.

§§ Beih. Bot. Centralbl., xxvi. 2te Abt., 1909, pp. 45-102 (3 pls. and figs.).

the Bolivian flora, which he enumerates in tables geographically arranged according to the localities which he explored, including the same in a bryo-geographical sketch. The new genera defined are *Polymerodon* (to be referred perhaps to the Dicranaceæ), *Simplicidens* (with the vegetative habit of a *Fissidens*), *Wolluya* (resembling Splachnaceæ in habit and Bryeæ in peristome).

Sphagnaceæ of Siberia.*—C. Jensen gives an account of the Sphagnaceæ collected by Arnell (in 1876) and others. These comprise twenty-seven species and some varieties. In addition to synonymy and distribution, the author supplies critical notes on the plants. The rest of the mosses and the hepatics were published by Arnell and Lindberg in 1889.

Mosses of Japan and Corea.†—J. Cardot publishes a further list of new mosses collected by Faurie and others in Japan and Corea, being a sequel to the lists in Bull. Herb. Boissier vol. vii. (1907) p. 709, and vol. viii. (1908) p. 331. The present paper contains descriptions of sixty-one species and varieties, nearly all of which are acrocarpous.

C. F. Austin: North American Bryologist.‡—E. G. Britton gives a biographical account of Coe Finch Austin (b. 1831, d. 1880). Many of the mosses and hepatics issued in his published sets were collected near his home in Closter, New Jersey. His *Musei Appalachiani* contained 450 numbers and were issued in 1870, followed by a Supplement of 100 numbers in 1878; and his *Hepaticæ Boreali-Americanæ*, with 150 numbers, were issued in 1873. His moss herbarium is in Columbia College, New York, and his hepatics in Manchester. He published some twenty-eight papers.

Charles Lacouture.§—C. C. Haynes publishes an obituary note on Charles Lacouture, who died at Dijon on November 7, 1908, aged 76. He was the author of an illustrated synoptical key to the French hepatics (1905), and of a similar key to the forty odd subgenera of *Lejeunea* (1908); and he left a nearly completed key to all the known genera of hepatics, which it is expected F. Stephani will finish and publish.

Thallophyta.

Algæ.

(By MRS. E. S. GEPPE.)

Phycoerythrin.||—E. K. Hanson publishes some observations on phycoerythrin, the red pigment of deep-water algæ. The object of his study was to throw light on (1) its role in assimilation, and (2) its chemical nature, suggested to be protein. The preparation of material was a difficulty, as the colouring matter occurs in very small proportion in most red algæ. *Ceramium rubrum* and other species of the genus yielded a fair quantity. The author describes his methods and then

* K. Svensk. Vet. Akad. Handl., xlv. No. 5 (1909) 18 pp.

† Bull. Soc. Bot. Genève, ser. 2, i. (1909) pp. 120-32.

‡ Bryologist, xiii. (1910) pp. 1-4 (portrait).

§ Tom. cit., p. 10.

|| New Phytologist, viii. (1909) pp. 337-44.

discusses the part played by phycoerythrin in assimilation, the chemical nature of phycoerythrin, and the action of proteolytic ferments on solution. His results appear to show that:—1. Phycoerythrin plays the part of assistant to chlorophyll by absorbing blue-green light and degrading it to the light which corresponds to the absorption bands i. and iii. of chlorophyll. 2. Phycoerythrin is probably a colloidal nitrogenous substance, related to protein—but not a true protein, as its nitrogen content is too low and it does not give the Biuret reaction. The evidence is incomplete; pure phycoerythrin has still to be prepared, and even comparatively pure phycoerythrin in sufficient quantity for extended chemical investigation has not yet been obtained.

Hybrid Fucus.*—C. Sauvagean writes on a hybrid between *Fucus vesiculosus* and *F. serratus*. In a previous work he recorded a hybrid plant from Cherbourg, and in the present communication he states that he has found similar specimens at St. Malo and at Ploumanac'h. The author describes briefly both the hybrid and the parents. He considers that the formula of the hybrid is *F. vesiculosus* ♀ × *F. serratus* ♂.

Epiphytes of Laminaria.†—F. Tobler writes on the epiphytes of the Laminariæ from a biological and morphological standpoint. The material was collected on the coast of Norway. He divides his remarks into general and special parts, and describes the different algæ which appear as epiphytes; the habitat and surroundings; the development of the epiphytic flora; the normal and pathological anatomy of the Laminariaceæ; the manner of attachment of certain epiphytes; the communities and relation to the animal world; physiology. He finds that the epiphytic flora consists mostly of small forms; larger plants occurring rather on the basal, and therefore perennial, portions of the host. The smallest forms grow partly over one another. The development and form of the basal organs of attachment in the epiphyte is of course an important factor, and this is fully dealt with by the author under the names of the different genera, *Rhodochorton*, *Chantransia*, *Ceramium*, *Ptilota*, *Poly-siphonia urceolata*, *Rhodymenia*, *Callophyllis*, *Delesseria*, etc. Some of the epiphytes may be regarded as half-parasites and saprophytes. In an appendix the author gives lists of species which were found growing only epiphytically in two localities; one contains twenty-three species, the other twelve.

Laminaria digitata and L. saccharina.‡—G. H. Drew writes on the reproduction and early development of *Laminaria digitata* and *L. saccharina*. After a short introduction, he gives a summary of the more important characters of the plants, and then describes his methods of collecting specimens, preservation of living specimens, examination of the reproductive areas, and culture methods. Detailed accounts are given of the reproductive process and the development of the young plant, and, finally, the author gives a summary of his results. These are as follows:—1. The *Laminaria* plant is the gametophyte. 2. The reproductive areas consist of gametangia and paraphyses. 3. Flagellated gametes escape

* C.R. Soc. Biol. Bordeaux, lxvii. (1909) pp. 832-3.

† Bot. Jahrb. f. Syst. Pflanzen., etc., Engler, xlv. (1909) pp. 51-90 (2 pls.).

‡ Ann. Bot., xxiv. (1910) pp. 177-90 (2 pls.).

from the gametangia, and isogamous conjugation occurs. 4. The resulting zygospore divides and gives rise to a chain or mass of cells. These may be of the "2x" type, or the reduction may occur in the early divisions of the zygospore. 5. The cells of this structure rupture, and their contents grow out and form the gametophyte. 6. The young gametophyte consists of a flat lamina, one cell thick, and is attached at its base to surrounding objects by a number of unicellular rhizoids. 7. The cells of the lamina divide, and eventually form the limiting and cortical layers and part of the medullary tissue. 8. The stipe is formed by a modification of the base of the lamina. 9. Part of the medullary tissue is formed by an upgrowth of cells from the base of the rudimentary stipe. 10. A disk-shaped expansion is formed at the base of the stipe, and from this the hapteres originate.

Dictyota dichotoma.*—W. D. Hoyt describes some interesting experiments made by him on *Dictyota dichotoma* at the laboratory at Beaufort, North Carolina. The cultures were started in the laboratory and then transferred to the harbour. The whole process is described, with the methods employed for preventing contamination. The results of the experiments show that the belief in alternation of tetrasporic and sexual generations in *D. dichotoma*, previously based on cytological evidence alone, is proved. The author summarises his conclusions as follows:—Plants of *D. dichotoma* raised from fertilised eggs gave thirty-three tetrasporic plants and no sexual ones. Plants raised from tetraspores gave sixty-four sexual plants and no tetrasporic ones. The tetraspores of a single plant produced both male and female plants, in one case in about equal numbers.

Laboratory Cultures under Gas.†—Z. Woycieki was incited, by a perusal of Pascher's work on *Mougeotia*, to undertake and publish some investigations on certain filamentous Chlorophyceae concerning their growth, regeneration, and propagation in laboratory cultures and under the influence of coal gas (Leuchtgas). He describes his results in some detail, and at the end of his paper gives a clear summary. In certain species of *Spirogyra* the influence of the gas is shown by disturbances of the morphogenetic process, which lead to peculiar pseudorhizoidal hypertrophies. Hand in hand with this occur also changes in the contents of the energids, as is seen in the degeneration of the chloroplasts and the precipitation of tannin-albumen compounds in a finely granular mass. Such a degeneration of the single energids of the filament produces a dissolution of these bodies in the gormogonial portions or in single cells, and these make an effort to bring about regeneration of the individuals. This regeneration does not, however, follow a normal course in certain species of *Spirogyra*, but is associated with hypertrophies, which generally appear in the end-cells of the new individuals. The degeneration and the dismembering of the hypertrophied cells form distinct evidence against the rhizoidal character of their outgrowths. *Cladophora fracta* var. *horrida* is far less sensitive in general than *Spirogyra* in laboratory cultures. Under certain doses of coal-gas, however, it forms either aplan-

* Bot. Gaz., xlix. (1910) pp. 55-7.

† Bull. Internat. Acad. Sci. Cracovie, No. 8 (1909) pp. 588-667 (figs. in text).

spores or cysts, both of which serve for the propagation of the organism. Besides this, the cells of *Cladophora* are also capable of taking on a palmella-condition under the influence of coal-gas. In certain cases, during the formation of aplanospores, there is a marked diminution of the number of nuclei in the interior of the cell as a consequence of karyogamy. The structure of the nuclei of aplanospores, cysts, and such like, differs from that of the nuclei in vegetative cells. The setting free of the aplanospores, and apparently also of the cysts, as well as of the palmella-like portions, takes place through a slimy degeneration of the coats, and of certain parts of the contents of the mother-cells, whereby it is made possible to eject the aplanospores from the cells. During all these processes there takes place, in most cases, a tearing asunder of the filaments into separate pieces, whereupon the various parts continue their growth in pseudorhizoidal fashion. Details are also given as to the behaviour of *Mougeotia genuflexa* in cultures.

Naturalisation of Algæ.*—C. Sauvagean writes a note on the difficulty of naturalisation of certain algæ in the Gulf of Gascony. For instance, *Ascophyllum nodosum* and *Himanthalia lorea*, though they are continually washed into the gulf in a fruiting condition, have never taken foothold and become established. The same occurs with *Cystoseira concatenata* and *Sargassum vulgare* var. *flavifolium*. On the other hand, *Cystoseira granulata*, which appeared to exist only north of the mouth of the Gironde, has been found not far from Guéthary, on rocks where it has clearly become well established, and grows at the same level as *C. ericoides*. Oddly enough, *C. granulata* is one of the species which is seldom thrown up into the Gulf of Gascony.

Marine Algæ and Currents.†—C. Sauvagean deduces certain interesting conclusions as to the direction of marine currents, from the fact that floating species of Fucoideæ are thrown up on the shores of the Gulf of Gascony. *Ascophyllum nodosum*, *Himanthalia lorea*, and *Cystoseira granulata* are often thrown up on the beach at Biarritz and Guéthary, and the author believes that they are carried northward from the coast of Galicia by a surface current, which is too weak to influence navigation, but is strong enough to float along marine algæ. *C. concatenata* and *Sargassum vulgare* var. *flavifolium* are also found among the shore debris, and are presumably washed along the shores of Spain and Portugal from the African coast. These slight marine currents can only be traced by the help of marine algæ, and have hitherto been overlooked.

Hints on Collecting and Growing Algæ.‡—J. A. Nieuwland gives some important directions for the growing of algæ brought home from excursions. Large aquaria are not necessary, the best results being often obtained with gallon or two-gallon jars. The algæ should, if possible, be grown in the water in which they were found. The water should not be changed, especially in the case of bog-algæ, and when it is necessary to renew the water not more than one-fifth the volume should be added,

* C.R. Soc. Biol. Bordeaux, lxvii. (1909) pp. 830-32.

† Tom. cit., pp. 829-30.

‡ Midland Naturalist, i. 4, Notre Dame, Indiana, 1909, pp. 85-97.

and tap water should be allowed to run for a moment to avoid the introduction of undesirable salts. If the water be too hard it can be made soft by growing *Chara* in it. Bacterial decomposition is best prevented by introducing only a small amount of material, not more than one cubic inch to the gallon. A little *Utricularia* will clear away undesirable animal life in the water. In the case of filamentous algæ good results have been obtained by strewing a layer of washed sea-sand on the bottom of the vessel. When the algæ disappear the culture should not be thrown out, for the forms usually reappear after a time. Mud and sticks from spots where algæ have been noticed may be brought into the laboratory in midwinter and soon yield vigorous cultures. By means of these cultures it is possible to study questions of periodicity in algæ, as well as their development, and to have at hand at all times a rich material for the use of students.

British Marine Algæ.*—E. M. Holmes exhibited at the Botanical Society of Edinburgh specimens of *Fucus inflatus* from Lerwick, Shetland, and *Colpomenia sinuosa* from the English Channel. He gave a short account of the invasion of the English shores by *C. sinuosa*, and of the damage which it had done to the oyster beds of France.

Marine Algæ of Dominica.†—S. Grieve gives a list of twenty species of marine algæ from the island of Dominica, which constitutes the first record from that island. The specimens were named by E. M. Holmes, who has added a few short notes.

Japanese Algæ.‡—K. Okamura has published two more parts of his valuable *Icones of Japanese algæ*. In them the following species are figured both in habit and structure:—*Hypnea variabilis* sp. n., *H. Saldana* Holmes, *Peyssonnelia involvens* Zanard., *Laurencia dendroidea* J. Ag., *Gelidium rigidum* Grev., *Hypnea musciformis* Lamour., *Laurencia concinna* Mont., *Eucheuma spinosum* J. Ag., *Halymenia formosa* Harv., *Polyopes Polyideoides* Okam., *Hyalosiphonia cæspitosa* Okam., g. et. sp. n., and *Valonia confervoides* Harv. The text is in English and Japanese.

Fresh-water Algæ in Nature.§—F. E. Fritsch and F. Rich have published the results of their five years observation of the Fish Pond, Abbot's Leigh, near Bristol. The object of their study was to obtain data concerning the periodicity of the algal flora, but they soon found that valuable sidelights were cast on other important problems. In the present paper they discuss the general consideration of the physical features of the pond and of the meteorological data; the more important constituents of the flora both cryptogamic and phanerogamic; general consideration of the life-cycle in the pond; general consideration of reproduction in the pond; and epiphytic forms. Under summary and general conclusions the authors give a full résumé of their results. They find that the algal flora of the Fish Pond, Abbot's Leigh, is dominated

* *Trans. Proc. Bot. Soc. Edinburgh*, xxiv. (1909) p. vii.

† *Tom. cit.*, pp. 7-12.

‡ *Icones of Japanese Algæ*, ii. Nos. 2-3 (Tokyo, 1909) pp. 21-61 (pls. 56-65).

§ *Proc. Bristol Nat. Soc.*, ser. 4, ii. pt. 2 (1909) pp. 27-54 (pl. and charts).

by a successive association (formation?) of *Cladophora*, *Spirogyra* and abundant Diatoms, both free-living and epiphytic, while the principal subsidiary forms are *Edogonium*, *Mougeotia*, and Cyanophyceæ. The algal flora shows a well-marked periodicity. Four phases are distinguishable in a normal annual cycle: (1) Winter-phase with an abundance of free Diatoms; (2) Spring-phase with dominant *Spirogyra*; (3) Summer-phase with dominant *Cladophora* and abundant epiphytes; (4) Autumn-phase, chiefly characterised by renewed activity after the inactive summer period, often with a prominent development of *Spirogyra*, *Edogonium*, or some other form. The reproductive processes in the pond show considerable uniformity, which is ascribed to the rather narrow range of temperature in the water. The epiphytic algal vegetation finds its chief host in *Cladophora*, and one of the most salient features in the annual cycle is the struggle between *Cladophora* and its epiphytes. The factors operating in the pond are of three kinds, seasonal, irregular, and correlated; these are discussed. Finally, the authors state that all their observations tend to indicate that the doctrine of limiting factors will probably be found to underlie the whole scheme of intricate changes that are so striking a feature of fresh-water algal vegetation.

Supplement to Engler's Pflanzenfamilien.*—N. Wille publishes a supplement to the volume of Chlorophyceæ in Engler's *Natürlichen Pflanzenfamilien*, which appeared about twenty years ago. In that time much work has been done on the group, and the author embodies it in the present supplement. In a preface he explains that he does not see his way to recognise the new groups of Heterokontæ and Akontæ, since the characters which distinguish them are found in the most different and widely separated sections of the green algæ; hence he regards the groups as unnatural. He adheres to the old divisions of Conjugatæ, Protococcales, and Chætophorales (= Confervales). Siphonææ is divided into two sections of equal value, Siphonocladiales and Siphonales. In the former section are placed, besides Valoniaceæ and Dasycladaceæ, the families Cladophoraceæ and Sphæropleaceæ. Another addition to the treatment of the Chlorophyceæ is the inclusion of a series of colourless organisms, hitherto reckoned with the fungi, and now regarded as akin to Volvocaceæ, Plenrococceaceæ, Oocystaceæ, and Edogoniaceæ.

Indian Ocean Plankton.†—F. Czapek gives a short account of plankton material which he collected in the neighbourhood of Karachi. He found it to consist entirely of diatoms, of which he enumerates twenty-eight species. Many of them have been already recorded in the plankton of the Gulf of Aden. The author then discusses the phosphorescent Peridiniæ of the Indian Ocean, and gives a list of eleven species, collected by himself, which produced phosphorescence. The species which takes the greatest part in this phenomenon is *Ceratium tripos*. Figures are given of stages of division in *Coscinodiscus symmetricus*, as well as of a *Dinophysis* which was continually found connected in pairs. Other stages of division were, however, not found in the latter species.

* Die *Natürlichen Pflanzen.*, Suppl. to Teil. i., 2^{te} Abt. (1909) 96 pp. (figs. in text).
 † SB. k. Akad. wiss. Wien, cxviii. (1909) pp. 231-9 (5 figs.).

Phytoplankton of Victoria Nyanza.*—C. H. Ostenfeld reports on some samples of plankton taken from the Victoria Nyanza, sent to him by Agassiz. The interest of the collection lies in the fact that it was made in the month of February, and can be compared with the plankton of April, October, and November, already known from that lake. In February *Melosira Agassizii* predominates with other diatoms of less importance, while green and blue-green algæ are rare; in April the green algæ predominate, as well as Desmids and Protococcoideæ, while diatoms are of less importance and blue-green algæ are rare; in October and November the Myxophyceæ predominate, the green algæ (especially *Botryococcus Braunii*) are subdominant as well as diatoms (*Melosira nyassensis* and *Surirellæ*), and the phytoplankton is very rich in species and individuals. In the second chapter the author enumerates the species observed in the collection entrusted to him, including 1 Peridiniales, 7 Bacillariales, 6 Myxophyceæ, and 15 Chlorophyceæ. Critical remarks are made, and *Melosira Agassizii* is described as new.

Swiss Plankton.†—C. H. Ostenfeld publishes notes on the temperature of the water, time of gathering, and contents of some samples of plankton from fifteen Swiss lakes.

Desmids.‡—L. Viret gives a list of Desmidiaceæ from the valley of Trient in Canton Valais, Switzerland. The plants were collected at stations which offered very different biological conditions, and the species sixty-nine in number, include twelve novelties. The author finds that Desmidiaceæ are rare in clear water, such as torrents or brooks, but are abundant in muddy water containing large quantities of humic matter. Critical notes are appended.

Devonshire Diatoms.§—J. B. Bessell mentions several interesting diatoms found by him last summer in the neighbourhood of Torquay. Among these are:—*Achnantheidium flexellum* Bréb., *Gomphonema intricatum* Kütz., *Achnanthes coarctata* Bréb., and *Navicula pusilla* W. Sm., at Anstey's Cove. *Pinnularia acrospheria* Bréb., *P. subcapitata* Greg., *Gomphonema subclavatum* Grun., and *Navicula elliptica* of quite unusual size, from Moretonhampstead. At Corbyn's Head several species were found, which had been recorded by Griffiths more than fifty years ago; as well as *Navicula inornata* Grun., a new record. The most interesting find was *Syndendrium diadema* Ehr., the spore form of *Chæloceros*, probably brought by a current.

The same author in another paper enumerates the Diatomaceæ of the Torquay district, which includes 203 species.

Biddulphia sinensis in the North Sea.||—C. H. Ostenfeld writes once more on this subject, which has been treated at length by him. An abstract of his work has appeared in this Journal,¶ and the present paper

* Bull. Mus. Comp. Zool. Harvard College, iii. (1909) pp. 171-87.

† Ber. Schweiz. Bot. Gesell., xviii. (1908) pp. 6-13.

‡ Bull. Soc. Bot. Genève, sér. 2, i. (1909) pp. 251-68 (1 pl.).

§ Journ. Torquay Nat. Hist. Soc., i. (1909) pp. 13-14, and 26-33.

¶ Internat. Rev. Hydrobiog. and Hydrog., ii. (1909) pp. 362-74 (9 figs. in text).

¶ See this Journal, 1910, p. 66.

by Ostenfeld is merely a long account of his previously published work. It concerns the immigration of a plankton diatom into quite a new area within recent years.

Fossil Diatoms.*—J. Héribaud has examined the diatoms of the Travertin strata laid down by the mineral waters of Sainte Marguerite, in Puy-de-Dôme. He finds that the Travertin may be divided into three zones, inferior, middle, and superior. The principal species of each zone are enumerated, but the new species are left over for another and later communication. More than eighty species were obtained, about a score of which are new to the Massif Central, and about half a score new to science. The author concludes with a short summary:—1. From the presence of numerous marine diatoms, in the lower Travertin, and from the almost complete absence of these species in the actual waters, it may be deduced that the waters of Sainte Marguerite must have been formerly much more strongly mineral than they are at the present day; their salinity has been constantly decreasing from the lower to the upper zone. 2. From the absence of marine diatoms in the actual waters, and from the presence, in the immediate neighbourhood of the mineral springs, of a fairly large number of plants belonging exclusively to a marine flora, it may be deduced that diatoms are more exacting, with respect to the mineralisation of water, than are the higher plants. 3. The examination of specimens taken at different levels allows the successive modifications of the diatom-flora to be followed with great exactness, and since the variations should correspond with those of the salinity of the water, it follows that a careful study of the Travertins would furnish exact information on the history of mineral springs.

New Genus of Pleurococcaceæ.†—W. Bialosuknia describes an alga which he, with the help of Chodat, has isolated from *Lecanora tartarea*. It forms the type of a new genus, and is called *Diplosp hæra Chodati*. Details are given as to the method of multiplication. The formation of zoospores has not been observed. The alga was grown in various nutritive solutions, which are described.

Protococcaceæ.‡—G. Guglielmetti begins a series of papers on the algal flora of Italy, the first contribution of which deals with the Protococcaceæ collected in and around Padua. Forty-five species are enumerated, to many of which critical notes are appended. One species and a few varieties are new.

Astrocladium cerastioides.§—O. Tschourina describes a new genus of algæ of which she has found one species in the duck-ponds of the Parc de l'Ariana, near Geneva. It belongs to the family Palmellaceæ, and may possibly be the same species as that described by Reinsch under the name of *Cerasterias raphidioides*, but the drawings and description of the latter are too incomplete to allow of certainty. The development and mode of division of the new alga are described.

* Comptes Rendus, cl. (1910) pp. 61-4.

† Bull. Soc. Bot. Genève, sér. 2, i. (1909) pp. 101-4 (1 pl.).

‡ Nuov. Notar., xxi. (1910) pp. 28-39.

§ Bull. Soc. Bot. Genève, sér. 2, i. (1909) pp. 98-101.

“Knee-joint” of *Mougeotia*.*—J. A. Nieuwland has studied “knee-joints” in several species of *Mougeotia*, and comes to the conclusion that it does not represent a stage in conjugation, for the joints are present only in vegetative stages, and never in typically conjugating material. “Usually the cells of the filament hold together so firmly that the cells break through the middle rather than separate at the ends; but in material with the knee-joints, the cells are easily dissociated, and, succeeding the appearance of the joints, the amount of material increases enormously, so that the joints seem to be related to vegetative multiplication.”

Algæ of Haute-Savoie.† — L. Viret publishes a list of sixty-three species collected on the mountain groups of La Tournette, La Fillière, and Les Aravis. The localities are briefly described, with their altitudes. Critical notes are added to some of the records.

Chrysomonadineæ of Bohemia.‡ — A. Pascher has worked out the species of this group found in Bohemia, and enumerates thirty-nine species. Five varieties are new.

New Genus of Chrysomonadineæ.§ — A. Pascher describes a new genus of Chrysomonads, *Pyramidochrysis*, found by him in the old bed of the Olsch river, in southern Bohemia, in 1909. The cells are pyriform-oval, somewhat rounded off at the base, and at the forward end more or less abruptly narrowed. A detailed description is given of the genus. Movement takes place by means of a single cilium, and the genus belongs therefore to the Chromulinaceæ. The movement of the cilium is peculiar, and resembles that of *Peranema*. *Pyramidochrysis* appears to be holophytic, and the well-developed chromatophore is sufficient for purposes of assimilation. Division takes place along its length: the process is described. Resting-states were observed, but the germination of these cysts was not seen. Two species are described, *P. splendens* and *P. modesta*.

Ourococcus bicaudatus.|| — A. E. Grobéty writes a short account of this alga, hitherto known as *Dactylococcus bicaudatus* Braun. She gives a short history of the species and of the confusion which has arisen as to its characteristics. Hansgirg has united it with *Characium pyriforme*, making it a variety. As a result of growing *O. bicaudatus* in a culture, the author finds that it differs from *Scenedesmus* by the absence of a cenobium; from *Lagerheimia* by its single prolongation, irregularly disposed; from *Raphidium* by its gibbous form (ventrue) and its asymetrically disposed points, which terminate the cell irregularly. The cells of this species which have two prolongations are not a variety, but merely one of the forms resulting from division, a process which is described by the author.

Green Snow.¶ — R. Chodat describes an appearance of green snow caused by a new species of alga, *Raphidium Vireti* (*Ankistrodesmus*

* Midland Naturalist, i. (1909) pp. 82-84. See also Bot. Gaz., xlix. (1910) p. 79.

† Bull. Soc. Bot. Genève, sér. 2, i. (1909) pp. 199-203.

‡ Lotos, lvi. (1909) 7 pp. (2 figs. in text).

§ Ber. Deutsch. Bot. Gesell., xxvii. (1909) pp. 555-62 (1 pl.).

|| Bull. Soc. Bot. Genève, sér. 2, i. (1909) pp. 357-8 (figs.).

¶ Tom. cit., pp. 294-97 (figs. in text).

Vireti). It was collected by Viret in a depression situated between the Aiguilles du Chardonnet and the Grands Mulets, at the edge of the Argenrière glacier. The colour of the snow was dirty green, and the patch extended a length of 30-40 metres, by 2-3 metres broad. In *R. Vireti* the points of the cells are excessively long and narrow, while in *R. nivale* Chodat the points are short. Both species are figured. The author mentions also a few other algæ found in coloured snow on the group of Mont Blanc.

Oxyrrhis marina.*—G. Senn has studied this organism and shows that it belongs to the Dinoflagellatæ, and not (as has been supposed) to the Flagellatæ. It multiplies by transverse division, not longitudinal as is found always in the Flagellatæ, and it possesses two grooves, one longitudinal the other transverse, from the bottoms of which arise the two flagella which distinguish it. One of these flagella is stretched out behind while the organism is in movement, while the other causes the cell to turn by means of its rapid undulatory vibrations. If it be taken for granted that *O. marina* has but one protoplasmic membrane it would then belong to the Gymnodiniaceæ, notably to Hemidinium. The removal of this species from Flagellatæ to Dinoflagellatæ removes the only exception to the rule that true Flagellatæ multiply only by longitudinal division.

Fossil Algæ.†—A. Rothpletz describes some fossil algæ from the Silurian beds in Gotland and Oesel. He treats of his subject under the following headings:—1. Calcareous algæ with intertwined cell-filaments. Under this section three algæ are described, one of which, *Sphærocodium gotlandicum*, is new. 2. Under calcareous algæ with cell-filaments placed regularly side by side the author deals with species of *Solenoporella* and *Solenopora*, one of which, *Solenopora gotlandica*, is new. The generic differences between these two genera are described and the relation that both hold to the Lithothamnia. After describing a new genus of Hydrozoa, containing two species, the author discusses the differences in growth, both micro- and macroscopical, between the balls of Hydrozoa and those composed of calcareous algæ.

Brothers Crouan.‡—F. Guéguen gives a short biographical notice of the brothers Crouan. Pierre-Louis Crouan was born in 1798, and Hippolyte-Marie Crouan in 1802. They had a chemist's shop in Brest, but retired from the business in 1860, and thenceforward devoted themselves to the study of Botany, especially Cryptogams. The flora of Finisterre was their special interest, in the study of which they explored the whole region exhaustively. They collected thus an immense amount of material; and this, including the algæ which had been published in sets in three octavo volumes in 1852, under the title *Algues marines du Finistère*, enabled them to write their famous *Florule du Finistère*. That work was the crowning production of their lives, and was carefully illustrated by Hippolyte. It is a catalogue containing 1031 phanerogams, 29 vascular cryptogams, 247 Muscineæ, 299 lichens, 2502 fungi, and

* Arch. Sci. Phys. Nat., period 4, xxviii. (1909) pp. 492-3.

† K. Svensk. Vetensk. Handl., xliii. (1908) 25 pp. (6 pls.).

‡ Bull. Trimestr. Soc. Mycol. de France, xxv. (1909) pp. 69-78 (2 portraits).

984 algæ, making a total of 5092 plants. Many of the species are merely enumerated, being already known, but descriptions are also included of 360 new species of Cryptogams (algæ and fungi). The original drawings for this work, executed in lead pencil and coloured, on bits of Bristol board, are preserved in the Laboratoire de Cryptogamie d'École de Pharmacie, and their general herbarium is said to be preserved at the Bibliothèque at Quimper. The list of their joint publications, mostly on algæ, amount to a total of twenty-six.

M. H. Foslie.*—G. B. De Toni writes a short obituary notice of Michael H. Foslie, curator of the Botanical section of the Museum at Trondhjem. He was born at Borge (Lofoten) on October 21, 1855, and in 1885 he was elected Conservator of the Museum at Tromsø. In 1892 he was appointed curator at Trondhjem, a position which he held at the time of his death. His first contributions to algology were on the subject of Arctic marine algæ and of *Laminaria*, published in 1881 and 1883 respectively. The marine algæ of Norway then occupied his attention, and he wrote a paper on the Norwegian forms of *Ceramium* as well as other contributions to the marine flora of his native land. But the greatest work of his life was his study of the Corallinaceæ, on which subject he knew more than any living botanist. He wrote a large number of papers on the subject, and but for his untimely death would have written a great work on the system of the group. De Toni had hoped that Foslie would elaborate that part of the *Sylogæ Algarum*, but Foslie refused, saying that he had yet more to examine and study before he would be ready to lay down finally his views. He was ever ready to help other botanists, and his loss will be sadly felt throughout the botanical world. A list is given of his published writings, which number sixty-eight.

- CLEMENTS, F. S., & SCHAUTZ H. LE ROY—**A New Genus of Blue-green Algæ, Eucapsis, with plate.** *Minnesota Botanical Studies*, 1. (1909) pp. 133-5.
- KOLKOWITZ, R.—**Ueber die Planktonproduction der Gewässer, erläutert an Oscillatoria Agardhii Gom.** (On the plankton-production of certain waters, as exemplified by *Oscillatoria Agardhii*.) *Landw. Jahrb. Ergänz.*, v. (1909) pp. 449-72 (pl.)
- MAZZA, A.—**Saggio di Algologia Oceanica.** (Notes on Marine algæ.) [A continuation.] *Nuov. Notar.*, xxi. (1910) pp. 1-27.
- MIGULA, W.—**Die Desmidiaceen (cont.)** *Mikrokosmos*, iii. (1909-10) pp. 131-4 (2 figs.).
- NONWEILER, G.—**Morphologische und physiologische Untersuchungen an Chara strigosa Br.** (Morphological and physiological investigations on *Chara strigosa* Br.) Zurich: (1908) 48 pp. (2 pls. and figs.).

Fungi.

(By A. LORRAIN SMITH, F.L.S.)

Life-history and Cytology of Potato-wart Disease.†—John Percival has made a study of the organism causing this disease, known as *Chrysophlyctis*, and he concludes that it really belongs to an older genus,

* *Nuov. Notar.*, xxi. (1910) pp. 56-62.

† *Centralbl. Bakt.*, xxv. (1909) pp. 440-7 (3 pls.).

Synchytrium. By culture experiments he was able to infect young tubers and watch the growth of the disease from stage to stage. The resting spores or sporangia germinate in the early spring and produce a large number of zoospores, which are oval or pear-shaped, with one cilium; these enter the young tissue of the buds on the thin rhizomes and the "eyes" of the young tubers. In three or four days after infection, proliferation of the tissue begins, producing the warts. There is a second form of sporangium produced in May and June, with thinner walls and smaller zoospores, but otherwise similar to the resting sporangia.

After entry into the host-cell, the parasite imbeds itself in the cytoplasm, and grows rapidly, soon being visible as a round thin-walled cell with a central nucleus, and reticulated cytoplasm with denser portions of irregular form. The nucleus contains a nucleolus, inside or around the surface of which the chromatin is concentrated, and attached to it is a peculiar and characteristic body of amœboid form, which extends a short distance into the nuclear cavity. At a later stage the reticulum breaks up into swarm-spores. The development of the thin-walled sporangium is also traced; the cytoplasm of this cell is more dense than that of the other; the primary nucleus is large, and is frequently placed excentrically; a round nucleolus is also present, which becomes vacuolated when the reproductive stage commences; at the same time the nucleus shrinks and disappears, the chromatin contained within it being found in the form of "chromidia" in the cytoplasm of the parasite. Round the chromidia small vacuoles appear, and nuclei arise at these points. The primary nucleus was not seen to undergo recognisable mitotic division, but undoubted mitosis was observed in the minute secondary nuclei.

Percival gives his reasons, based on the life-history and development of the organism, for placing it in the genus *Synchytrium*, and he further suggests that the *Synchytria*, and possibly the majority of the Chytridiaceæ, may ultimately be placed among the Protozoa.

Aspergillus glaucus.*—L. Mangin has studied this mould in order to clear up the confusion as to the species included under that name. He defines the species as having large globose or ovoid slightly warted conidia (9–15 μ in diameter). *Aspergillus repens*, which has often been united with the above, has much smaller conidia (7–8.5 μ in diameter), and also smaller ascospores. Mangin therefore divides the forms into two groups: 1. *A. glaucus*, with large conidia and spores; 2. *A. repens*, including those with smaller conidia and spores; but he also found that there was so much variation in the conidial form as regards size and ornamentation of the conidia, due to temperature, etc., that it was not possible to distinguish species by single conidia. Among the large spored forms he recognises only one species, *A. glaucus*, but among the smaller he differentiates *A. Amstelodami* sp. n., *A. Chevaleri* sp. n., *A. repens*, and *A. herbariorum*. Mangin gives a long account of his cultures and of the observations made on temperature, coloration, etc.

Study of Endomycetes.†—A. Guilliermond had undertaken a study of this order of fungi to throw some light on the formation of the ascus

* Ann. Sci. Nat., sér. 9, x. (1909) pp. 303–71 (15 figs.).

† Rev. Gén. Bot., xxi. (1909) pp. 353–98, 401–19 (8 pls. and figs.).

and on the systematic position of the closely allied Saccharomycetes. He finds that the formation of the spores in *Eremascus* is exactly comparable with the same process in *Saccharomyces*, and that the ascus of the one is homologous with that of the other. In *Endomyces fibuliger* there are variations from these forms, though they are closely allied: there are only four spores formed in the ascus instead of eight, and there is no trace of sexual conjugation. *Saccharomyces capsularis*, another closely allied form, differs in the total absence of any anastomosis of hyphæ, which is a feature of *Endomyces fibuliger*. He finds, however, in *E. magnusii* a true heterogamic conjugation representing sexual reproduction. It is also characterised by a much-branched mycelium.

Guilliermond describes at great length the development of these different fungi, compares them one with another, and discusses the views on their systematic positions held by various authors. He finds little difference between *Endomyces fibuliger* and *Saccharomyces capsularis*, and places them in the same genus; he shows further their affinity with *Eremascus*. The latter should include forms characterised by the absence of conidia, and an 8-spored ascus derived from an isogamic conjugation. Guilliermond's study of these various types leads him to conclude that the yeasts are derived from a form akin to *Eremascus fertilis*. From that original form he traces two lines, the one including *Endomyces fibuliger*, *E. capsularis*, *Zygosaccharomyces*, and the Saccharomycetes, the other *Endomyces magnusii* and the Schizosaccharomycetes.

Cytological Observations on the Yeast Plant.*—H. Wager and A. Peniston refer to a previous paper published by Wager on the yeast-cell nucleus in which he stated that the combined nucleolus and vacuole constituted the nucleus of the cell. They give the views of other workers who contest this statement, and describe their methods of culture, fixing, and staining employed to enable them to make a new examination of the subject. They conclude again, as a result of their work, that the nucleus consists of nucleolus and vacuole; the vacuole contains a clear nuclear sap, a network of strands which occur mainly at the periphery, and one or two bright metachromatin (volutin) granules. The nucleolus always occupies a position at the side of the vacuole and projects into the cytoplasm of the cell. There is no well marked nuclear membrane. The nuclear vacuole varies in size and seems to disappear entirely during spore-formation. The nucleolus and the network of the vacuole may become impregnated with chromatin, and these give a distinct reaction for phosphorus and iron. The cytoplasm contains bright volutin granules, and glycogen is abundant at certain stages.

In the process of bud-formation the nucleus divides amitotically into two equal or unequal portions, one of which passes into the daughter-cell with a portion of the vacuole and chromatin. In spore-formation the nuclear vacuole and network disappear, the nucleolus becomes closely surrounded by chromatin granules and then divides by elongation and constriction; the two daughter-nuclei divide in a similar manner to form the spore-nuclei.

* Ann. Bot., xxiv. (1910) pp. 45-83 (5 pls.).

Notes on Tilletiæ.—F. Bubák* has added another to the three known species of *Tilletia* on cultivated cereals. It grows on *Hordeum* and infests the seedling plants. The spore masses are violet-brown and fill the sheaths of the seeds. The epispore in the new species is much darker than in the other species of the genus.

P. Magnus† described in Hedwigia‡ a form of *Tilletia* in the fruits of *Bromus secalinus*, which he named *Tilletia Belgradensis*. He has been informed by Hariot that the same fungus was described on *Bromus erectus* as *Tilletia guyotiana* in 1900. Bubák also found it on *Bromus arvensis* in Bulgaria, and described it as *Tilletia Velenovskyi*. Hariot's name being the earliest takes precedence. The fungus has been now reported on three species of *Bromus*, and has been collected in France, Servia, Bulgaria, and Russia.

Otto Appel§ has experimented with barley and wheat to test the value of hot water as a fungicide. It was found that the treatment was absolutely effective in killing the smut spores if the grain was first soaked from 4 to 6 hours in water at a temperature of 20° to 30° C., and then treated either with water or air for about 20 minutes at a temperature of 50° to 54° C. These temperatures are quite harmless in their effect on the germinating power of the seed. The double treatment secures the germination of the fungus spores in the first soaking, and their prompt destruction by the greatly increased heat.

Uredineæ.—W. Krieg|| finds that *Uromyces Dactylidis* is a compound Uredine, and after a series of cultures he concludes that it represents four different species, all of which form their uredospores on *Dactylis glomerata*, and their *Æcidium*-form on different plants—(1) on *Ranunculus platanifolius*, *R. aconitiferus*, *R. alpestris*, and *R. glacialis*; (2) on *R. bulbosus* and *R. repens*; (3) on *R. silvaticus*, and (4) on *R. lanuginosus*.

He points out that *R. bulbosus* and *R. repens* are also the alternative hosts of *Puccinia magnusiana*.

O. Schneider-Orelli¶ publishes notes on willow *Melampsoræ*. He distinguishes three groups. In two the teleutospore membrane is not thickened, but one has elongate, the other round uredospores, while the third group has a thick wall to the teleutospores and round uredospores. He also gives a special account of *Cœoma Saxifragæ*.

E. W. D. Holway,** in his Notes on Uredineæ V., corrects the nomenclature of several species of *Puccinia*, and gives notes as to hosts and locality.

Ernst Schaffnit†† has devoted his attention to the question of the capacity to germinate and the germination of uredo- and æcidiospores of rusts. Various authors have already written on the question, and Eriksson added the lack of germinative capacity in these spores as reason for the necessity of his mycoplasma theory. Schaffnit found as a result of his experiments that temperature exerted considerable influ-

* Zeitschr. Landw. Versuch. Oesterr., xii. (1909) p. 545. See also Centralbl. Bakt., xxv. (1909) pp. 526-7.

† Hedwigia, xlix. (1909) p. 100.

‡ Op. cit., xlvi. (1908) p. 145.

§ Ber. Deutsch. Bot. Gesell., xxvii. (1910) pp. 606-10.

|| Centralbl. Bakt., 2te Abt., xxv. (1909) pp. 430-6.

¶ Tom. cit., pp. 436-9.

** Mycologia, ii. (1910) pp. 23-4.

†† Ann. Mycol., vii. (1909) pp. 509-23.

ence; also that spores were not ripe so long as they remained attached to their stalks, and that the maturing of the spores depends on particular temperatures.

J. Vleugel* has published a paper on the *Phragmidia* of *Rubus*. He divides the species into two groups: those with paraphyses (six species); and without paraphyses (one species—*P. Rubi-Idæi*).

F. Mühlethaler† made a series of cultures with coronate rusts. With teliospores from *Calamagrostis varia* he infected several species of *Rhamnus*; and with æcidiospores from *R. alpina* he reproduced uredospores on *Calamagrostis*. He does not think the Uredine is identical either with *Puccinia coronata* or *P. coronifera*. With æcidiospores from *Rhamnus cathartica* he produced uredospores on *Bromus erectus* var. *condensatus*, and on several species of *Festuca*. Later, he found *Bromus erectus* at the same locality with a good growth of coronate teliospores. The author thinks he may be dealing with a biological species of *Puccinia coronifera*.

Deformations caused by Uredineæ.‡—Ruth Stampfli considers these under three heads: galls, deformations of flowers, and deformations of stems and of leaves. The galls may be formed on leaves usually on the veins, on the leaf-stalks, and on the stems. In the leaves the palisade parenchyma takes part in the gall-formation; in leaf-stalk and stems the pith, wood-cells and cambium grow out, and in a lesser degree the bark, bast, and epidermis. As regards flower deformations, the petals, etc., are changed often to vegetative leaves; other changes that occur are also described. In stems and leaves witches' brooms are formed, leaves are thickened, and their shape altered. In general, it is found that the tissue formed approaches more nearly to parenchyma in form, and this seems to indicate a return to more primitive tissue.

Fungi of Brandenburg.§—R. Kolkwitz gives an account of the Schizomycetes—the bacteria—of this province, both economic and pathogenic. He gives a history of the study of this group of organisms, describes their development and habitat, and then gives a systematic account of genera and species.

E. Jahn begins the discussion of the Myxobacteriaceæ, giving a history of their discovery, and tracing their life-history and development.

Notes on some Larger Fungi.||—W. A. Merrill publishes a coloured plate of nine different species of fungi—species of *Leotia*, *Dictyophora*, *Mutinus*, and *Scleroderma*—with full descriptions, and notes on each of the species.

H. J. Banker¶ traces the history in literature of Linnæus' plant, *Hydnum parasiticum*, confused later with *H. strigosum* Swartz. The latter plant is very rare in America, and is now classified as *Gloiodon strigosum*.

* Svensk. Bot. Tidssk., ii. (1908) pp. 123-38 (5 figs.). See also Ann. Mycol., vii. (1909) p. 306.

† Centralbl. Bakt., 2te Abt. xxvi. (1910) p. 58.

‡ Hedwigia, xlix. (1910) pp. 230-67 (27 figs.).

§ Krypt. Flora Mark Brandenburg. Pilze, Leipzig, Gebrüder Borntraeger, v. 1 (1909) 192 pp. (5 pls.).

|| Mycologia, ii. (1910) pp. 1-6 (1 pl.).

¶ Tom. cit., pp. 7-11.

M. F. Barret * gives full synonymy and descriptions of three species of *Auricularia*: *A. auricula*, *A. nigrescens*, and *A. mesenterica*, all of them found in America. They have been described under many different names.

W. A. Murrill † publishes a new genus of Phalloids collected near Cinchona, Jamaica, which he names *Protophallus*. It resembles the egg of a Phalloid, but it never elongates, and shows no trace of a stipe. Unlike other members of the order, it is odourless.

F. von Hohnel ‡ collected a number of the larger fungi in South Tyrol. He found *Cyphella fasciculata*, a North American species, on alder leaves; it had been previously collected in Venetia. Critical notes and corrections are appended to the descriptions of species.

Symington Grieve § exhibited before the Edinburgh Botanical Society a specimen of *Schizophyllum commune* on the fruit of the coco-nut palm; the nut had germinated, and then the shell had been cracked or rotted off, exposing the endosperm on which the fungus had grown. The specimen was found in Dominica, at the mouth of a rivulet. These coco-nuts resist sea-water, and it was suggested that experiments might be made to see if the spores of the fungus would retain their vitality after being soaked in sea-water.

H. Mayr || has attempted to introduce forest culture of edible fungi, especially of species of truffle. He bases his recommendations on his knowledge of Japanese methods, and he made experiments with a much-appreciated Japanese fungus, *Agaricus shitake*. The success was not clear, but he hopes to carry on the experiments with other Japanese edible species.

J. S. Bayliss ¶ has made a biological cultural study of *Polystictus versicolor*. He obtained from the germinating spores an *Oidium*-forming mycelium, then a few months later the proper mycelium, which developed into the pilei of the fungus. He found that it grew easily on ash, mountain-ash, sycamore, horse-chestnut, or birch, not so easily on alder, oak, or elm. No culture was successful in the laboratory; the fungus grew only in the open air, and best in warm weather. Changes of moisture in the atmosphere gave rise to zone-formation. Light influenced the coloration of the zones and the formation of the pores; the latter were never produced in the dark. The author also deals with the enzymes of the fungus and its destructive power on wood. The mycelium is remarkably long-lived: it revived after being dried up four years.

W. A. Murrill ** describes the cultivation of an edible mushroom in Formosa, called by the natives "Shutake." It is highly esteemed by the Chinese and Japanese, and had been recently introduced from Japan. The oak-tree, on which it grows, is cut down and rice-water is thrown over it at intervals to prepare it for the mushroom. Murrill also mentions that the edible mushroom of Jamaica, known by the native name "Junju,"

* Mycologia, ii. (1910) pp. 12-18.

† Tom. cit., pp. 25-6.

‡ Oesterr. Bot. Zeitschr., lix. (1909) pp. 62-6 and 103-12.

§ Trans. Proc. Bot. Soc. Edinburgh, xxiv. (1909) pp. xii-xiii.

|| Nat. Zeitschr. Forst.-Landw., vii. (1909) pp. 274-9. See also Ann. Mycol., vii. (1909) p. 563.

¶ Journ. Econ. Biol., iii. (1908) pp. 1-22 (2 pls.). See also Hedwigia, Beibl., xlix. (1909) p. 25.

** Mycologia, i. (1899) pp. 274-5 (1 fig.).

grows on bogs, but there is no attempt at cultivating it. The natives search for it eagerly, and consider it a great delicacy.

Larger Fungi of Rhine-land.*—A first list of Agarics is published by Gustav Herpell, and instructions are given as to collecting and preserving species. Herpell has had great success in preparing and mounting specimens for the herbarium, and at first he advised against their poisoning. He now finds that the preparations are liable to be attacked by insects or by moulds, and he considers it necessary to poison them with a 2 p.c. solution of mercuric chloride in methylated spirits (90 p.c.). With this solution he paints the back of the gelatin paper on which the fungi are pressed, and further he paints over the specimens with celluloid varnish. Herpell describes the natural features of the locality in which he collected the fungi. He gives notes as to habitat, etc., and with each species the size of the spores.

German Fungus-flora.†—W. Migula continues his work on the fungi of Germany. He begins the third section with a discussion of the Basidiomycetes, which he considers under two divisions, the Hemibasidii and the Eubasidii. The Hemibasidii include the Ustilaginaceæ; the Eubasidii are subdivided into two great groups, the Protobasidiomycetes and the Autobasidiomycetes.

Migula has already finished his description of the Ustilaginaceæ and has begun with the Protobasidiomycetes, the first order being the Uredinales or rust fungi. The genera are illustrated by coloured or by black and white plates.

Mycological Notes.‡—Franz v. Höhnelt continues his notes and criticisms on systematic mycology, with special reference to species occurring in Java. Many new species are described, and the following new genera: *Koordersiella* and *Loranthomyces* (Sphaeriaceæ); *Cocoidella* and *Discothitis* (Dothideaceæ); *Trichopeltopsis*, near to *Dimerosporium*; *Schiffnerula* (Englerulaceæ); *Myxasterina*, near to *Asterina*; *Micropoerella* (Sphaeroideæ); *Japonia* (Excipulaceæ); *Araneomyces* (Tuberculariæ); and *Strunellopsis* (Tuberculariæ dematiæ); the last a parasite on leaves of *Vaccinium*. Notes on some Myxomycetes are also added.

Atlas of Fungi.§—L. Rolland has for some time been issuing coloured plates of fungi of France, Switzerland, and Belgium. As the series is finished, he has issued in pamphlet form descriptive notes of 283 species, represented on 120 plates. The first pages discuss the larger fungi, generally explaining the method of classification and the structure of these plants. Particular attention is paid to locality and time of growth, and to the edible or poisonous nature of those described.

Poisonous and Edible Fungi.||—F. Guéguen contributes the concluding chapters to Rolland's Atlas of Fungi. He gives descriptions of poisonous species, with an account of the symptoms of poisoning,

* Hedwigia, xlix. (1909) pp. 135-212.

† Flora von Deutschland, lief. 80-4 (1909) pp. 241-320 (25 pls.).

‡ SB Akad. Wiss. Math.-Nat. Kl., cxvii. 1 (1909) pp. 813-904 (3 figs.).

§ Paris: Paul Klincksieck (1910) 107 pp. || Tom. cit., pp. 108-20.

and the methods of treating people who have been poisoned. Scientific estimation reckons the number of those at about 10,000 each year, though only a comparatively small number of cases are fatal. Guéguen also discusses the value of fungi as an article of food, by examining the composition of the various parts of a series of edible forms. He concludes that fungi provide a complete food, and various experimenters have existed on them alone for several weeks. They are more nutritious than most vegetables, and provide a food of the greatest utility. An index of the whole volume is added.

Microfungi in Cheese Curds.*—A. Wolff undertook the examination of milk that had failed to produce the necessary curds for cheese. He found an *Oidium* and three forms of *Cladosporium*. He cultivated these fungi on gelatine plates, and gives an account of their growth and development. Some other organisms were also found in the milk, species of bacillus.

Chemical Study of Fungus Cell-sap.†—C. Gerber has carried out a series of experiments on the cell-sap of a number of the higher fungi, to determine the curdling reactions of each. He expressed the juice of young and fresh plants, and tested it with milk. The results are recorded in tabular form. He found that, in this regard, the most active cells were those in the neighbourhood of the hymenium in gilled species; in others, such as perennial Polyporeæ, the cells of the pileus were more active. He tested also the effect of heat, and found the most susceptible were those that grew in autumn, when there are no extremes of heat or cold. The more resistant forms were those that grew in winter (*Tricholoma nudum*, etc.), and in their power of coagulation they approached the higher plants.

Ferments of Fungi.‡—Pringsheim and Zempten have made press-extracts of various fungi, and tested the fermentative power of the substance. In some cases the extract gave negative results, while the residue was found capable of active fermentation, showing that the active principle could not be separated from the body of the cell. In the case of *Aspergillus Wentii* both extract and residue were active. Some of the fungi were able to use as food disaccharides which they were unable to ferment.

Biological Experiments with Fungi.§—K. Kominami has attempted to throw some light on the subject of the inheritance of acquired characters by growing generation after generation of filamentous fungi in certain media. He took conidia of *Aspergillus niger* and grew them in a normal solution; other conidia that had been grown in a salt solution; and a third series that had been under the influence of salt solution for ten generations. He found that when these conidia, produced under different conditions, were sown on a highly concentrated salt medium, the first failed to germinate, the second germinated fairly well, while the third grew vigorously. Kominami could not carry the experiments

* Centralbl. Bakt., xxiv. (1909) pp. 361-73 (3 pls.).

† Comptes Rendus, cxlix. (1909) pp. 944-7.

‡ Hoppe-Seyler's Zeitschr. Physiol. Chemie, lxii. (1909) pp. 367-85. See also Bot. Gaz., xlix. (1910) pp. 74-5.

§ Journ. Coll. Sci. Tokyo, xxvii. 5 (1909) 33 pp. (3 pls.).

beyond the conidial form. He records the finding of sexual characteristics in *Mucor racemosus*.

Plant Diseases.—F. J. Chittenden * records a disease of *Lavatera trimestris* caused by *Colletotrichum malvarum*. The first symptom is the appearance of small yellowish-brown spots on the upper surface of the leaves, stalks, and stems. The spots gradually extend owing to the spread of the mycelium, and the tissue dies off.

A disease of *Antirrhinum* is also reported due to an allied fungus *Septoria Antirrhini*. This also begins with yellowish leaf spots. Both of these fungi are particularly fatal on the stems of the plants, as they spread all round and quickly kill the host. Spraying with Bordeaux mixture is recommended in both cases.

R. Lucks † records a fungus which he found infesting the outer sheath of earth-nuts. He was led to examine these carefully, as cattle, etc., fed on nut-meal were often unwilling to eat it and not infrequently appeared to suffer from poisoning after partaking of the nut-meal. Lucks found a minute fungus, which he names *Coniothecium arachnidium*, infesting the sheaths of the nuts, especially on the inner side. He made a large series of cultures on various media and under different conditions of temperature, and gives a full account of all his culture experiments.

T. H. Middleton ‡ contributes a report on destructive insects and pests. The fungal diseases are chiefly cases of potato-wart disease, due to *Chrysophlyctis endobiotica*, and the American gooseberry mildew; for both of these destructive diseases he suggests remedies, and instructs growers how to deal with the pests.

In the same Journal § information is given as to the control of plant diseases in Germany. There are twenty-seven principal stations throughout the country for dealing with pests. The most common diseases dealt with during the year were the potato-wart disease, American gooseberry mildew, and a root disease of wheat caused by a fungus *Ophiobolus herpotrichus*.

A stem and root disease of *Viola tricolor* has been determined by F. A. Wolf || to be due to *Fusarium Violæ* sp. n. The plants die off quickly, and show a dark slightly sunken area on the stem, just at the surface of the ground. The root system is almost entirely destroyed. Precautions should be taken not to fertilise with barn-yard manure immediately before planting, as that seems to encourage if not to cause the disease.

A number of parasitic microfungi were noted by D. Cruchet ¶ in the valley of Tourtemagne during an excursion of the Société Murithienne. He found *Contractia Caricis* on three species of *Carex*, and a Pyrenomycete on Liliaceæ; several parasitic Sphæropsidæ were also noted.

G. Köck ** describes three very troublesome fungus diseases, *Pseudo-peronospora cubensis*—which attacks cucumber-plants and is wide-spread

* Journ. R. Hort. Soc., xxxv. (1909) pp. 213-17 (2 figs.).

† Centralbl. Bakt., xxiii. (1909) pp. 642-55 (3 pls.).

‡ Journ. Board Agric., xvi. (1910) pp. 845-8.

§ Tom. cit., pp. 848-9.

|| Mycologia, ii. (1910) pp. 19-21 (1 pl.).

¶ Arch. Sci. Phys. Nat. Genève, xxviii. (1909) pp. 190-2.

** Verh. k.k. Zool. bot. Ges. Wien, lix. (1909) pp. 48-57. See also Centralbl. Bakt., xxv. (1909) pp. 519-20.

in Austria. Experiment proved that the different varieties of cucumber were not all equally liable to take infection, and that the fungus varied in the size of the conidia according to the species on which it grew. Bordeaux mixture has been used with good results as a fungicide. Köck reports also on the American gooseberry mildew, which was introduced with bushes from infected countries. Bordeaux mixture was effective in checking the fungus. Leaf-rolling in potato-plants is due also to a fungus, but weather conditions are powerful agents in inducing the germination and growth of the parasite.

L. Hauman-Merck and J. A. Devoto* have published the first attempt at a complete survey of plant diseases in Argentina. They chronicle the occurrence of Phycomycetes, such as *Cytospora*, *Plasmopara* (on the vine), and *Peronosporæ* (on cabbage, lucerne, and spinach); one Hyphomycete, *Oidium* (on vine); Erysiphaceæ (on beans, oats, and roses); *Apiosporium* (on cherry); *Sclerotinia libertiana* (on beans); *Exoascus deformans* (on cherry), and *Pseudopeziza medicaginis* (on lucerne).

A considerable number of rusts have also been identified on wheat, oats, and maize, on fruit-trees, clover, shrubs, and trees, also smuts on maize and other cereals and grasses. Several species of Sphærospideæ have also been diagnosed belonging to the genera, *Glaeosporium*, *Cercospora*, and *Septoria*. *Mycoidaea parasitica* was found on leaves of magnolia, and *Cuscuta* on lucerne.

Diseases caused by insects are also included in the work.

H. Klebahn † has studied a disease of celery that has been doing much harm in the market gardens round Hamburg. The tubers and base of the stem are affected, and the sheathing leaves on which the fungus grows become scabbed and unsightly. If the celery is used in the early season, not much damage is done, but in cases where it is earthed up for later use, rotteness sets in and there is great loss.

One of the fungi causing the mischief is *Septoria Apii*, but other species of Sphærospideæ are also to be found on celery, notably *Phoma apiicola*, which is parasitic on roots, leaf-sheaths, and leaf-bases. The fungus passes the winter in the soil, and attacks the young plants in spring.

The diseases of cultivated plants have been treated in two divisions for the Encyclopédie Agricole. The first, by G. Delacroix ‡ describes the various pathological conditions of the plant organisms as represented by teratological formations induced by wounding, frost, soil, conditions, etc.

The same author, § along with A. Maublanc, has written on parasitic diseases induced by phanerogams, fungi, bacteria, and epiphytes. Causes that lead to attack, and methods of treatment, are dwelt on, and the whole made useful to the cultivator.

Some diseases of cultivated plants from the tropics have been recorded by Brick, || especially those that attack economic plants such

* Bol. Minist. Agric. Buenos Aires, x. (1908) pp. 98–113. See also Bot. Centralbl., xxv. (1909) p. 520.

† Zeitschr. Pflanzenkr., xx. (1910) pp. 1–40 (2 pls. and 14 figs.).

‡ Paris: J. B. Balliere (1908) xii. and 431 pp. (58 pls.).

§ Paris (1909) 452 pp. (83 pls.). See also Centralbl. Bakt., xxv. (1909) pp. 518–19.

|| Jahresh. Ver. Angew. Bot., 1908 (Berlin 1909). See also Centralbl. Bakt., xxv. (1909) pp. 522–3.

as cocoa, on which he found a *Fusarium* that killed the branches, and which required their cutting and burning in order to save the tree. Seedling cocoa plants were attacked by *Pestalozzia guépini*; the roots by *Hymenochæte noxia*. Coffee trees were attacked by *Nectria Behinskiana*, and by a Hyphomycete, *Pellicularia koleraja*.

L. Petri* publishes further notes on the diseases of olive trees in Italy. On the young leaves he found *Phyllosticta Oleæ* sp. n., which causes spots; the fruits were often attacked by bacteria, which gave rise to gummosis, and the roots were covered at the tips by a mycorrhiza which prevented further development. At the tips of the roots he also found the perithecia of a new fungus, *Cryptoascus oligosporus* g. et sp. n.

F. Bubak† reports on the work done at Tabor in Bohemia during the year 1908. Pine trees were attacked by *Macrophoma bohémica* and by *Rehmiellopsis bohémica* g. et sp. n., the latter an Ascomycete with a many-spored ascus. *Steganosporium Sirakoffii* sp. n. did considerable damage to young trees of *Morus nigra*. Tomatoes suffered from *Macrosporium Solani*. *Sphærotheca Mali* was found on apple trees, and *Oidium Quercinum* on oak, with perithecia.

F. C. von Faber‡ has published a monograph dealing with the various diseases to which cocoa trees are liable, a number of them being caused by parasitic fungi, such as *Phytophthora* sp., which induces a brown-rot. He devotes considerable space to methods of fighting the various diseases.

F. W. Neger§ has studied the diseases of the seeds of forest trees. The failure of these seeds to germinate arises from various causes, but in many cases it has been traced to the presence of fungi. He found spores in acorns, chestnuts and pine trees that were very similar to smut-spores, and *Urocystis* has been demonstrated on edible chestnuts. A disease of red chestnut seeds was also caused by a fungus, mycelium being found within the seed-coats. On cultivation, *Botrytis cinerea* was constantly produced; infection had probably occurred during the flowering season.

W. J. Gallagher|| has described some root diseases of *Hevea brasiliensis*, the Para rubber tree. *Fomes semitostus* is one of the worst; it envelops the lateral roots with a fine white felt and quickly kills them. The spores germinate only saprophytically on dead wood, and the fungus then passes to the living root.

In another paper¶ the author describes a branch and stem disease of *Hevea* caused by *Corticium Zimmermanni*; it checks the flow of latex and causes the early fall of the leaves.

E. S. Salmon** reports on Economic Mycology—work connected with fungoid plant diseases that has been undertaken at Wye during 1908. Diseases of various fruit trees, flowering plants and vegetables were

* Atti Reale Accad. Lincei, xviii. (1909) pp. 635–42 (4 figs.).

† Zeitschr. Land. Versuch. Oesterr. Wien, 1909, pp. 453–6. See also Hedwigia, Beibl., xlix. (1909) p. 72.

‡ Arb. k. Biol. Anst. Berlin, 1909, pp. 193–351 (1 pl. and figs.). See also Hedwigia, Beibl., xlix. (1909) pp. 72–3.

§ Tharandt. Forstl. Jahrb. Leipzig, lx. (1909) pp. 222–52 (figs.). See also Hedwigia, Beibl., xlix. (1909) pp. 73–5.

¶ Dept. Agric. Federated Malay States, Bull. No. 2 (1909) 13 pp.

** Op. cit., No. 6 (6 pp.). See also Ann. Mycol., vii. (1909) pp. 562–3.

** South East Agric. Coll. Wye (London, 1909).

treated. Experiments were undertaken to test the resistance of *Chryso-phlyctis* sporangia to frost; their germinating power was not destroyed after an exposure to temperatures varying from 5° to 8° C. for four hours.

Mycorhiza of *Sempervivum*.*—Franz Zach describes the formation of fascicles of short roots in *Sempervivum* which recall the appearance of witches' brooms. He found in the cells of these roots the slender hyphæ of an endophytic mycorhiza, and he found also the stouter mycelium of a Hyphomycete. Whether the short roots are caused by the mycorhiza or whether they are an adaptation to xerophytic conditions the author does not say, as experimental research would be necessary to determine this.

ALMEIDA, JOSÉ VERISSIMO D' & MANOEL DE SOUZA DA CAMARA—**Contribuições ad Mycofloram Lusitanæ.** (Contributions to the fungus-flora of Lusitania.)

[Several new species are published in the list, which numbers 500 specimens.]
Bol. Soc. Brot., xxiv. (1908-9) pp. 150-213.

BITTMAN, OTTO—**Die holzstörenden und holzersetzenden parasitaren, sowie saprophytischen Pilze unserer Laubhölzer im Wald und auf den Lagerplätzen.** (Wood-destroying parasites, and the saprophytic fungi in forest and timber-yards.) *Oesterr. Forst. und Jagd.-Zeit.*, xxvii. (1909) pp. 74-6, 84-5, 95-6, and 135-6 (5 figs.). See also *Hedwigia*, Beibl., xlix. (1909) p. 26.

BLOOMFIELD, E. M., & E. W. SWANTON—**Sussex Fungi: Preliminary List.** [A list of Hymenomycetes and Gasteromycetes found in the county.]
Hastings and Sussex Naturalist, i. (1909) pp. 131-52 (4 pls.).

BURLINGHAM, G. S.—**Lactariæ of North America. Fasc. i.-ii.** [Habitat and distribution in America are given.]
Mycologia, ii. (1910) pp. 27-36.

CRUCHET, DENIS—**Micromycetes nouveaux.** (New Micromycetes.) [Several new species from Valais.]
Bull. Soc. Vaud. Sci. Nat., xlv. (1909) pp. 469-75 (3 figs.).

FISCHER, HUGO—**Ueber *Coremium arbuscula* sp. n.** [Diagnosis and description of the new species, with notes on the genus.]
Ber. Deutsch. Bot. Gesell., xxvii. (1909) pp. 502-4 (2 figs.).

KNISCHEWSKY, O.—**Tagessringe bei *Penicillium luteum*.** [Culture experiments which proved that ring-formation in fungal cultures were due to effects of light.]
Landw. Jahrbücher, xxxviii. (1909) p. 341.
See also *Bot. Centralbl.*, cxliii. (1910) pp. 120-1.

KNOLL, F.—**Eine neue Art der Gattung *Coprinus*.** (A new species of the genus *Coprinus*.) [The fungus *Coprinus stiriacus* sp. n. grew in hot-houses and in the open; it is allied to *C. pseudoplicatilis*.]
Oesterr. Bot. Zeitschr. Wien, lix. (1909) pp. 129-33 (2 figs.).
See also *Hedwigia*, Beibl., xlix. (1909) p. 64.

KORPATCHEWSKA, IRÈNE—**Sur le Dimorphisme physiologique de quelques Mucorinées Hétérothalliques.** (Physiological dimorphism of some heterothallic Mucorini.) [The difference between the two sexes is apparent in their chemical behaviour (chimisme) and in their growth.]
Bull. Soc. Bot. Genève, sér. 2, i. pp. 317-51 (1 pl. and 4 figs.).

* SB. Akad. Wiss. Math.-Nat. Kl., cxviii. (1909) pp. 185-200 (3 pls. and 4 figs.).

- KRIEGER, W.—**Zwei neue sächsische Pilze.** (Two new Saxon fungi.)
[Two species of microfungi are described.] *Ann. Mycol.*, vii. (1909) p. 542.
- LINDNER, P.—**Catenularia fuliginea (Saito) ein Schulbeispiel zur Demonstration der Sporenkettenbildung.** *Catenularia fuliginea*, a school example for demonstration of spore-chain formation.)
[Photographic figures, and notes as to the formation of the spores.]
Ber. Deutsch. Bot. Gesell., xxvii. (1909) pp. 530-6 (1 pl.).
- MAESTRO, CÉSAR SOBRADO—**Datos para la Flora Micologica gallega.**
[A list of fungi collected in November, mostly in Cataluna.]
Bol. Hist. Nat., ix. (1909) pp. 491-4.
- MAGNUS, P.—**Beitrag zur Kenntnis der parasitischen Pilze Ägyptens.** (Contribution to the knowledge of the parasitic fungi of Egypt.)
[The species described are chiefly Uredineæ; there are no new species.]
Hedwigia, xlix. (1909) pp. 93-9 (1 pl.).
- MASSE, G.—**Fungi exotici. IX.**
[Sixteen new species of *Boletus* are described, and *Strobilomyces paradoxus* sp. n., from Singapore.] *Bull. Roy. Bot. Gard. Kew*, 1909, pp. 204-9.
- MOESZ, G.—**Gombák Budapestről és környékéről. (I. Közleménig.)** (Fungi from Budapest and the neighbourhood (first contribution).)
[140 species are listed; a number are new to science.]
Beibl. Bot. Közlemenyek, 1909, heft 4-5, 31 pp. (1 pl.).
See also *Ann. Mycol.*, vii. (1909) p. 560.
- MOFFATT, W. S.—**The Higher Fungi of the Chicago Region. Part I. The Hy-menomycetes.**
[A large number of known species were collected.]
Chicago Acad. Sci. Nat. Hist. Survey, Bull. No. vii. (1909) pp. 1-156 (24 pls.) See also *Ann. Mycol.*, vii. (1909) p. 560.
- NOELLI, A.—**Alcuni micromiceti dell' Ossola.** (Some Micromycetes from Ossola.)
[A list of species, with notes on the development of many of the forms; there is one new species, *Mollisia fagicola*.]
Malpighia, xxiii. (1909) pp. 171-84 (1 fig.).
- PATOUILLARD, N.—**Additions au catalogue des Champignons de la Tunisie.**
[Fungi observed or collected in Tunis and Algiers, including many rare and some new species.]
C.R. Congr. Soc. Sav., 1908 (Paris, 1909) pp. 242-56.
See also *Ann. Mycol.*, vii. (1909) pp. 560-1.
- PETCH, T.—**New Ceylon Fungi.**
[A number of new fungi and two new Mycetozoa are described.]
Ann. Roy. Bot. Gard. Peradeniya, Colombo, iv. (1909) pp. 299-307.
See also *Bot. Centralbl.*, cxliii. (1910) p. 19.
- REHM, H.—**Ascomycetes exs. Fasc. 45.**
[Nos. 1851 to 1875 are listed; several of them are new to science.]
Ann. Mycol., vii. (1909) pp. 524-30.
- „ **Ascomycetes novi.**
[Fifteen new species are described from North America; from South America there are nineteen, with one new genus, *Phæofabræa*.]
Tom. cit., pp. 531-42.
- RITTER, G.—**Ammoniak und Nitrate als Stickstoffquelle für Schimmelpilze.** (Ammonia and nitrates as a source of nitrogen for filamentous fungi.)
[Culture experiments were made with a series of fungi, and results given.]
Ber. Deutsch. Bot. Gesell., xxvii. (1910) pp. 582-88.
- SCHROEDER, E. C. AUG.—**Ueber die Craterellus-Arten im allgemeinen und den Craterellus nucleatus sp. n. im besonderen.** (On *Craterellus* species generally and on *C. nucleatus* in particular.)
[The new species is good for eating; it has been carefully described.]
Centralbl. Ges. Forstw., xxxiv. (1908) pp. 396-404 (1 fig.).
See also *Hedwigia*, *Beibl.* xlix. (1909) p. 64.

SYDOW, H. & P.—**Fungi Paraënses.**

[The list includes a large proportion of new species.]

Hedwigia, xlix. (1909) pp. 78–84.

„ „

Einige neue resp. bemerkenswerte Pilze aus Südafrika. (Some new and noteworthy fungi from South Africa.)

[Six new species are described and others recorded, with notes.]

Ann. Mycol., vii. (1909) pp. 543–7.

Lichens.

(By A. LORRAIN SMITH.)

Lichen Flora of the Saal Valley.*—H. Zsacke has published a list of lichens he has collected, and along with it a short geological sketch of the neighbourhood. The calcareous rocks vary greatly in the amount of calcium contained in them, and this variation tells at once on the lichen flora. Where the two types of rock with much or little calcium are closely associated, the species of lichen may pass over from one rock to the other, but they become untypical and show differences both in thallus and size of spores.

Russian Lichens.†—In his report on the vegetation of the Sseliger Lake (Gouv Twer, Ostaschkow), Elenkin gives an account of the moss and lichen formations in the neighbourhood of the lake, more especially on the sandy soil. The most characteristic species were *Stereocaulon condensatum*, *Cladonia verticillata*, *Bacomyces roseus*, *B. byssoides*, and a new and interesting form, *Placynthiella arenicola* g. et sp. n. Some rare crustaceous Lichens were also found on stones, e.g. *Rhizocarpon postumum* and *Acarospora oligospora*.

Lichens from Brazil.‡—A Zahlbruckner has had charge of the lichens collected by the Austrian Botanical Expedition of 1901 to South Brazil. He has determined 297 species, many of them new to science. He gives notes and new diagnoses of many species already known, especially in Graphideæ, in which family the apothecia have often been imperfectly described. The different groups are all fairly well represented, though the more noticeable foliose and fruticulose forms are the most numerous. The *Parmeliæ* are specially abundant, and Zahlbruckner gives a synoptic key to enable the students to determine these and other specimens with greater ease. The paper is illustrated by five plates of coloured photographs.

Italian Lichens.§—In the present issue A. Jatta commences the study of Heterolichenes. These he divides into (1) Epiconiaceæ, (2) Discocarpaceæ, and (3) Pyrenocarpaceæ. The first includes only the coniocarps, a comparatively small group. The second is the largest, and consists of nearly all the foliose and fruticulose lichens as well as the

* Zeitschr. Naturw., lxxx. (1908) pp. 231–53. See also Bot. Centralbl., cxxii. (1910) pp. 91–2.

† Bull. Jard. Imp. Bot. St. Petersburg, ix. (1909) pp. 15–21. See also Hedwigia, Beibl., xlix. (1909) p. 54.

‡ Denkschr. k. Akad. Wiss. Math.-Nat. Kl., lxxxiii. 2 (1909) 125 pp. (5 pls.).

§ Flora Italica Cryptogama. Lichenes, i. fasc. 2 (1909) pp. 113–264.

crustaceous Lecanoreæ, Lecideæ, and Graphidaceæ. The last group is not yet touched on. With each family he gives a figure of the outstanding characters of the genera, and a bibliography of important works bearing on the special group. Diagnoses are written in Latin. A synoptic key to the species is given at the head of each genus.

Primitive Lichen.*—Elizabeth Acton has examined *Botrydina vulgaris*, and finds that it is not, as is sometimes supposed, a green alga, but is a composite plant consisting of a central group of algal cells imbedded in mucilage, which is traversed by fungal hyphæ, both plants growing symbiotically together. The fungal hyphæ formed an envelope of considerable thickness. She concludes that it should be regarded as a lichen, possibly one of the most primitive of existing lichens. Alga and fungus are able to live separately. *B. vulgaris* occurs in damp situations among mosses on rocks or on the ground.

Useful Plants among Lichens.—V. Schiffner divides such plants into three categories.

1. Edible lichens for men or animals.—The gastronomic quality depends on their content of lichenin and isolichenin (lichen-starch). Lichenin is always associated with a bitter principle, but it can be removed by frequent washing, and the plants made serviceable to man. Such lichens are *Cetraria islandica*, *Cladonia rangiferina*, *Everniæ*, *Sticta pulmonacea*, *Gyrophora proboscidea*, *G. cylindrica*, *G. esculenta*, *Alectoria sulcata*, and *Lecanora esculenta*.

2. Lichens as medicine.—*Cetraria islandica* is the only one of service. *Chlorea vulpina* is used by peasants in Norway to poison foxes, and Alpine dwellers employ *Thamnolia vermicularis* in lung disease of pigs.

3. Lichens in the Arts.—The following dyes are obtained: orchil, cudbear, orchil-extract, French purple, and litmus. These are extracted from *Roccellæ*, *Dendrographa leucophæa*, *Pertusaria dealbata* var. *violaria*, *Lecanora tartarea*, and *Umbilicaria frustulata*. *Sticta pulmonaria* is a substitute for hops in the brewing of beer; *Physcia ciliaris* and *Evernia prunastri* are used in perfumery; *Cetraria islandica* and *Cladonia rangiferina* are occasionally used in the preparation of alcohol.

Absorption of Water by Lichens.†—F. Sievers confirms Zukal's observations on this subject, viz. that crustaceous lichens absorb water from the upper surface only; foliose lichens on both surfaces. Among crustaceous lichens there are modifications of this rule; in some species there are no cracks on the surface, and in that case the water penetrates by injured places, or in others at the edge of the thallus. *Parmeliæ*, with black, impenetrable under surface, absorb water from above; where rhizinae are well developed, they serve to hold water. In shrubby lichens the hygroscopic nature of the thallus provides for absorption from the moisture of the atmosphere; thus *Cladonia retipora*

* Ann. Bot., xxiii. (1909) pp. 578-85 (1 pl.).

† Naturw. Wochenschr., xxiv. (1909) pp. 65-72 (25 figs.). See also Bot. Centralbl., cxiii. (1910) p. 22.

‡ Wiss. Beil. 33 Jahresber. Ber. Landw. Schule Marienberg, Ostern. (Helmstadt, 1908). See also Hedwigia, Beibl., xlix. (1910) p. 108.

almost equals *Sphagnum* in its absorptive capacity. Mucilaginous lichens have great power of swelling up, and so of absorbing and retaining water.

BACHMANN, E.—*Die Flechten des Vogtlandes*. (Lichens of Vogtland.)

[Of 278 species only 185 were crustaceous forms, owing to the lack of limestone and old trees.]

Abh. Nat. Ges. Isis, Dresden, 1909, pp. 23-42.

See also *Hedwigia*, Beibl., xlix. (1910) p. 107.

HARMAND—*Notes relatives à la Lichenologie du Portugal*.

[431 species are listed, collected chiefly by R. P. Cordeiro in the neighbourhood of Seterbal.]

Bull. Soc. Bot. France, lvi. (1909).

HAVAAS, JOHAN—*Beiträge zur Kenntnis der westnorwegischen Flechtenflora*. (Contributions to the study of the West Norwegian lichen-flora.)

[The list includes some species and varieties new to science.]

Bergens Museums, Aarborg, i. (1909) pp. 1-36.

See also *Bot. Zeit.*, lxxviii. (1910) pp. 15-16.

HUE—*Le Mastoidea tessellata* Hook. fil. and Harv.

[A controversy as to the nature of the plant has been settled by the development of lichen fruits.]

Bull. Soc. Bot. France, lvi. (1909) 8 pp. (5 figs.).

See also *Bot. Centralbl.*, cxi. (1909) p. 622.

” **Lichens.**

[An account of some lichens collected at Tangiers, with a discussion of the systematic value of *Roccella portentosa*.]

Act. Soc. Linn. Bord., lxxiii. (1809) 4 pp.

See also *Bot. Centralbl.*, cxi. (1909) p. 623.

MAHEW, J.—*Notes relatives à la Cryptogamie de l'Espagne. Les Lichens du Montserrat*.

[Seventy-seven species of lichens from Montserrat, including an exotic species, *Polycauliona maheni*.]

Bull. Soc. Bot. France, lvi. (1909) 19 pp. (3 figs.).

MARC, F.—*Catalogue des Lichens recueillies dans le massif de l'Argoual et le bassin supérieur de la Dourbie*. (Lichens collected on the heights of Argoual and the upper basin of the Dourbie.)

Acad. Int. Bot., xviii. (1908) 98 pp.

See also *Bot. Centralbl.*, cxliii. (1910) pp. 20-1.

PETROW, J. P.—*Die Flechten des Moskauer Districts*. (The lichens of the Moscow district.)

[The author records twenty-two species, and a further list of fourteen.]

Bull. Jard. Imp. Bot. St. Pétersbourg, ix. (1909) pp. 73-90.

See also *Hedwigia*, Beibl., xlix. (1909) p. 64.

WAINIO, E. A.—*Lichenes insularum Philippinarum I*. (Lichens from the Philippine Islands.)

[A number of new species, shrubby and leafy lichens, are included in this list.]

Phil. Journ. Sci., iv. (1909) pp. 651-62.

Mycetozoa.

(By A. LORRAIN SMITH.)

Text-Book of Mycetozoa.*—C. Torrend tells us in his preface that his projected list of fifty-one species observed by him in Portugal gave place to a full account of all the known members of the group. Seeing there was no complete work on the Mycetozoa in French, he now publishes the complete account in the French language. He begins by

* *Flore des Myxomycetes*, S. Fiel (1909) 270 pp. (9 pls.).

giving a biological account of Mycetozoa, their growth and reproduction. Torrend concludes that they are related to fungi rather than to animals, and retains for them the title Myxomycetes. He gives directions to the student how to collect and how to preserve these minute organisms, and how to make microscopic preparations. He gives detailed keys to families, genera, and species, and publishes plates of genera and species.

Mycetozoon Parasites.—J. E. Blomfield* and E. J. Schwartz have studied the tumours of *Veronica chamædrys*, and of the organism causing them, a parasitic Mycetozoon, *Sorosphæra Veronicæ*. The tubercles vary in size from a pin's head to that of the last joint of the little finger. The parasite is largely local in its action, and does little damage to the host-plant. The Mycetozoon has no power to penetrate through the cell-walls, and spreads by the dividing of the host-cell containing it; primary infection takes place in the vicinity of the growing points of the stem. At the final stage the infected cells are mostly filled with the spherical zoospheres of wedge-shaped spores. Nuclear division was observed, and is carefully described.

E. J. Schwartz † publishes a preliminary note on another species of *Sorosphæra Junci*, which attacks the roots of various species of *Juncus*. The life-history is very similar to that of *S. Veronicæ*.

Schizophyta.

Schizomycetes.

New Bacillus in Cheese. ‡ — H. Huss describes *Pseudomonas cowardi*, a new bacillus isolated from a sample of Cleveland cheese sent to him from Yorkshire. This is a short, Gram-positive, motile, non-sporing organism, possessed of one flagellum. It grows well on ordinary media and ferments dextrose, but not lactose or mannite. Indol is formed. Gelatin is not liquefied, nor milk clotted. Associated with "rusty spots" in cheese, this bacillus also forms a reddish-yellow pigment in cultures, which is soluble in absolute alcohol, but not in water.

New Lactic-acid Streptothrix. § — From Dadhi, an Indian sour-milk preparation, G. C. Chatterjee has obtained an organism, which he assigns to the class Körnchen bacilli of Lehmann and Neumann, a group allied to the Streptothrices. It grows well on glucose-agar, forming convoluted chains. In specimens stained with methylen-blue, it is seen that while the bacillus stains blue, it contains pink granules placed at regular intervals. It has been thought that these are glycogen granules; they are certainly not spores, as they are not resistant to heat. In other respects, this organism resembles *B. bulgaricus* and its congeners. It coagulates casein in milk, and produces a large quantity of lactic acid. When inoculated with certain pathogenic bacilli into milk, it destroys them rapidly.

* Ann. Bot. xxiv. (1910) pp. 35-43 (1 pl.).

† Tom. cit., p. 236.

‡ Centralbl. Bakt., 2te Abt., xxv. (1909) pp. 401-6.

§ Op. cit., 1te Abt. Orig., liii. (1910) pp. 103-12.

Resistance of various Bacteria to Alterations in Osmotic Pressure.*—Alfred Guillemard added varying quantities of salts of alkalis and alkaline earths to broth, and observed the influence of the thus altered physical conditions of the culture medium upon the growth of different types of bacteria. In this preliminary notice of his researches he gives a few figures which show that *Bacillus megatherium* is, of the organisms submitted to experiment, the least tolerant of such changes, whereas *Staphylococcus pyogenes* possesses relatively high powers of resistance. The organisms of the so-called coli-typhoid group occupy an intermediate position. The author is of opinion that these variations in toleration of such physical conditions are sufficiently constant to afford a useful means of differential diagnosis between, for example, *B. Friedlanderi* and *B. lactis aerogenes*, organisms difficult to distinguish by the methods at present in use.

Comparative Study of Streptothrix pyogenes and Actinomyces hominis.†—R. Chiarolanza compares the morphological and cultural characters of these organisms, as well as the effects of their inoculation into experimental animals. As regards their cultural characters, he finds that there are many points of similarity between the two types. Both grow well upon agar, forming whitish adhesive colonies, the *Streptothrix* colonies being as a rule larger. On glycerin-agar, *Streptothrix* colonies appear dark yellow, sometimes black. Both liquefy gelatin. Neither form produces hæmolysis on blood-agar plates. As regards their morphological characters, both forms consist of threads of various lengths with true branching. Vacuoles appear in the threads in old cultures. Both forms are Gram-positive. *Streptothrix pyogenes* is acid-fast, *Actinomyces hominis* is not; but acid-fastness in the streptothrices is a variable character, susceptible of modification by passage and other means. So that the value of this as a diagnostic point must not be overestimated.

Cladothrix stereotropa.‡—G. Proca and P. Danila point out that this organism, which is found in syphilitic products, exists in four types: a bacillary form with pseudo-branching; a *Streptothrix* form; a diphtheroid form; and a coccobacillary form. Injected into animals (rabbits and mice) it gives rise to abscess or septicæmia.

Streptobacillus niger gangrænæ pulmonaris.§—G. Repaci isolated from a gangrenous lung a streptobacillus which has some morphological resemblance to *Streptococcus pneumoniae*. It is easily stained, and is Gram-positive. It is an essential anaerobe, and grows only at incubation temperatures. The growth on sugar-agar consists of small circular colonies, at first opaque, but becoming black in about a fortnight. Fluid media are rendered turbid; the growth is deposited as a whitish sediment. It does not form gas or indol. It does not attack sugars, but glucose is slightly fermented. The cultures exhale a strong putrefactive odour. It is extremely pathogenic to animals.

* C.R. Soc. Biol. Paris, lxxvii. (1909) pp. 538-40.

† Centralbl. Bakt., 1te Abt. Orig., liii. (1910) pp. 1-11.

‡ C.R. Soc. Biol. Paris, lxxviii. (1910) pp. 190-3 (6 figs.); and pp. 79-81.

§ Tom. cit., pp. 216-18.

Spores of *Bacillus perfringens*.*—B. L. Melikov found that the spores were best cultivated in white of egg broth (bouillon blanc d'œuf) and stained by Ziehl's method with a weak decoloriser (1 p.c. sulphuric acid). The vitality of the spores is great. In aerobic cultures, mixed with *B. coli* on agar slopes, they grow in about fifteen days, and in white of egg broth deprived of air for four or five years they may also give colonies. The spores are killed at 100° in a few minutes. The spores are large, oval, and usually central. When small and young the spores stain more deeply than when fully developed.

- BARBER, M. A.—**The Effect on Mice of Minute Doses of *B. anthracis*.**
Journ. Infect. Diseases, vi. 1909, pp. 634-61.
- KRUYFF, E. DE—**Les Bactéries thermophiles dans les Tropiques.**
Centralbl. Bakt., 2^{te} Abt., xxvi. (1910) pp. 65-74.
- RANKIN, A. C.—**Germicidal Action of Metals and its Relation to the Production of Peroxide of Hydrogen.** *Proc. Roy. Soc.*, Ser. B, lxxxii. (1910) pp. 78-87.
- SAVAGE, W. G.—**Differentiation of Streptococci by means of the "Goat Test."**
Rep. Local Govt. Board, 1909, Appendix B 3, pp. 294-315.
- „ „ **Etiology of Paratyphoid Fever and the Relationship of Paratyphoid Bacilli to other members of the Gaertner Group.**
Op. cit., Appendix B 4, pp. 316-40.
- WIDAL, F., P. ABRAMI, E. JOLTRAIN, E. BRISSAUD, & A. WEIL—**Serodiagnostic Mycosique. Applications au diagnostic de la Sporotrichose et de l'Actinomyose. Les coagglutinations et cofixations mycosiques.**
Ann. Inst. Pasteur, xxiv. (1910) pp. 1-33.

* C.R. Soc. Biol. Paris, lxxvii. (1909) pp. 806-7.



MICROSCOPY.

A. Instruments, Accessories, &c.*

(1) Stands.

Watson's Naturalist's Microscope.†—This instrument (figs. 18 and 19) is an inexpensive Microscope, and is intended for students and for

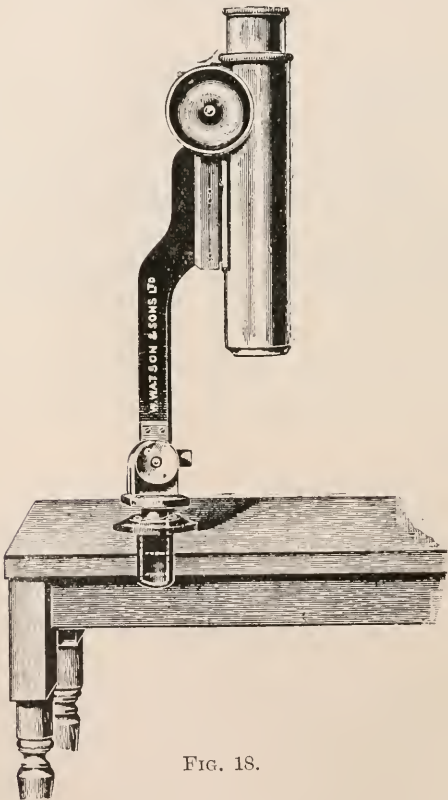

FIG. 18.

biological class work. The base for the Microscope is formed either by the case, or by the bench on which it is to be used. The illustrations show the instrument (1) with stage and mirror removed, fitted in

* This subdivision contains (1) Stands; (2) Eye-pieces and Objectives; (3) Illuminating and other Apparatus; (4) Photomicrography; (5) Microscopical Optics and Manipulation; (6) Miscellaneous.

† Watson and Sons' Special Catalogue.

socket and fixed to bench or table (fig. 18) ; and (2) when mounted in socket on side of containing case (fig. 19).

Binocular Loups of Weak and Medium Magnification.*—O. Henker and M. von Rohr discuss the principles which must underlie stereoscopic vision, with especial reference to the image in space. If an object-point be selected, the principal rays proceeding from it must

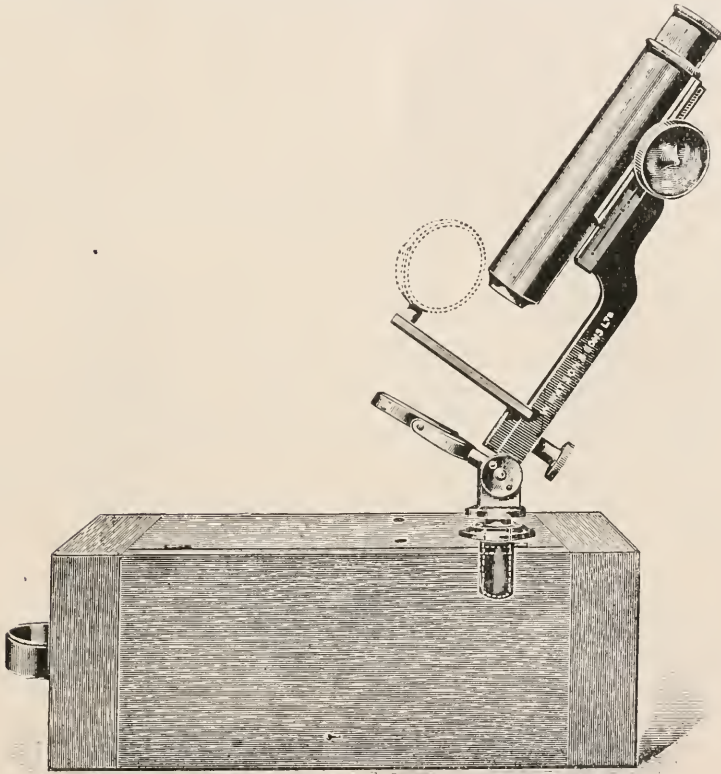

FIG. 19.

first be determined. These principal rays are those which diverge from the object to the centres of the entrance-pupils of the right and of the left instrument. After their passage through the instrument, these rays generally leave the exit-pupils at an increased refraction-angle to their corresponding axes. A space-image, in the sense of geometrical optics, occurs when the directions, produced backwards, of the principal rays pertaining to a selected object-point, intersect in a point of the space-image. The combination of all such space-points will give the true space-image of the whole object. If such a condition, incontestable as a proposition in geometrical optics, be satisfied, it is, furthermore,

* *Zeit. f. Instrumentenk.*, xxi A (1909) pp. 280-6 (7 figs.).

possible to discuss the conditions of the allied subject—viz. the change whereby the perspective arising in the space-object is presented to the eye. That change is closely connected with the above condition. It must at the same time be supposed that the observer's eyes remain accommodated for infinity. Yet it cannot be asserted that these conditions as to accommodation-adaptability of the eyes are ever completely satisfied. But it will be difficult to deny the authors this simplifying assumption if the similar condition be conceded without hesitation in the clearer case of monocular instruments. In any case the conditions should be plainly and clearly laid down on which the consequent explanation depends.

In many instruments intended for binocular use there is no space-image, in the sense of geometrical optics, owing to the fact that in many cases the rays do not intersect, but merely cross one another. But since the observer, even in such instances, not infrequently receives a uniform impression, the explanations must be sought for in physiological rather than in geometrical optics. The result of the authors' view, therefore, is to very much narrow down the ground on which binocular instruments should be treated, and to lay a sure foundation for explaining the construction of selected forms. The space-image, in the strict sense, will only arise when the axes-directions of the system serving both eyes are parallel in both the space-object and in the space-image, and when there is also exact and similar correspondence between the planes of the object and the planes of the images.

Moreover, it is possible to consider systems with a common objective—under these circumstances the space-object possesses only a single position-plane—or with both systems completely separated, and set up parallel to each other.

The authors then discuss the application of their principles to double loupes.

(2) Eye-pieces and Objectives.

Watson's 1/6 and 1/12 Objectives.*—The essential features claimed for these lenses (figs. 20, 21) are the capability of bearing high eye-pieces without breaking down; the capability of utilising a large solid cone of

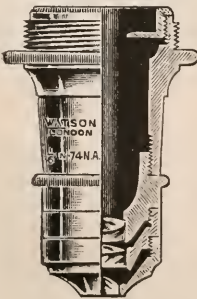

FIG. 20.

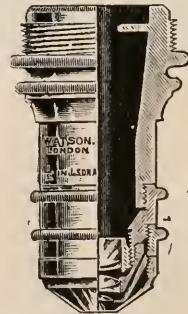

FIG. 21.

illumination; perfect centring; a definition which leaves no doubt as to the structure examined.

* Watson and Sons' Special Catalogue.

(3) Illuminating and other Apparatus.

Zehnder's New Half-shadow Polarimeter.*—L. Zehnder reports that this half-shadow polarimeter has proved itself very useful for the examination of elliptically polarised light. The chief parts are shown in fig. 22. The goniometer used in its construction was von Lang's. The parallelised rays, proceeding from the objective *O* of the slit-tube *C*, pass through the polariser *P*. They then traverse the Soleil-Babinet compensator *K*, and the new half-shadow analysing arrangement *A*. All these parts are in front of the telescope objective. The polariser *P* is rotatory about the slit-tube axis, and a finely divided circle *T*₁ is closely connected with it. This circle is coarsely adjustable, and also, by means of the screw *S*₁, finely adjustable; the rotation is read off in degrees and minutes by a vernier. The compensator *K* is intended to convert into a directly polarised beam the light reflected at the surface under examination, and more or less elliptically polarised, of the body set on the goniometer. The compensator consists (i.) of a plane-parallel

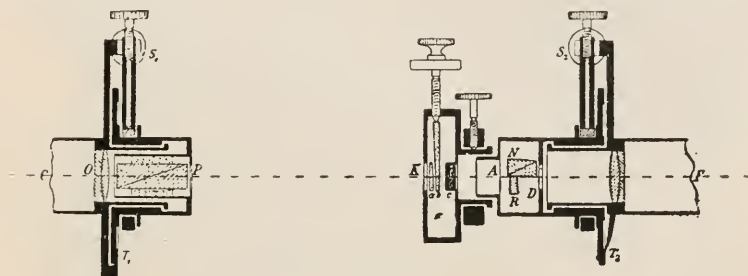

FIG. 22.

quartz plate *c* of uniform thickness, and (ii.) of two quartz wedges *a* and *b*, which together form a plane-parallel plate of variable thickness. The optical axes of *a* and *b*, on the one hand, and of *c* on the other, are orientated in the well-known manner, perpendicular to each other. The half-shadow analysing arrangement *A* consists of the half-prism *N* and of the plane-parallel dark glass *R*, which together half cover up the field of view defined by the circular diaphragm *D*. The divided circle *T*₂ is closely connected with this analysing arrangement, and can be rotated about the telescope axis; the movement is partly coarse and partly, by means of the screw *S*₂, fine; the vernier reads to degrees and minutes. The opacity of the dark glass plate is so selected that the diaphragm *D* under the light used is perfectly visible, and for this reason the ocular lens of the telescope *F* is made of variable width by means of an ocular slit. The well-known conditions of the Lippich half-shadow polarising apparatus are made use of in adjusting the half-prism and the dark glass. As the dark glass in each rotation of the analyser about the telescope axis transmits a uniform quantity of light, there occurs on each side of every dark adjustment of the half-prism an adjustment for half-shadow equality—that is, for uniform brightness

* Ann. d. Physik., xxvi. (1908) p. 985. See also Zeit. f. Instrumentenk., xxix. (1909) pp. 296-8 (1 fig.).

of the whole field; between these positions the position of maximum darkness of the half-prism lies midway. As the adjustment for uniform illumination admits of greater precision than that for maximum darkness, this analysing arrangement is more accurate than a single nicol. It is, moreover, especially advantageous to have two positions of adjustment, and to take their mean.

The reflecting plane of the glass body is, by means of an auto-

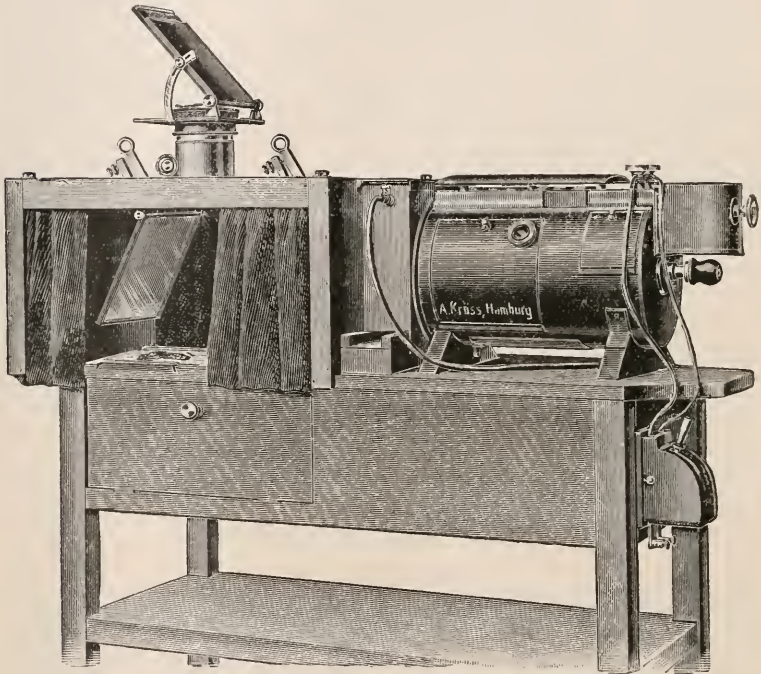

FIG. 23.

collimation ocular, provided with cross-threads, set parallel to the rotation axis of the goniometer, whereby the polarising planes of the analyser and polariser are parallelised with great accuracy, being perpendicular to the goniometer rotation axis. Consequently, it is likewise possible, with great accuracy, to calibrate the drum divisions of the compensator, and to so adjust the rotatory compensator about the telescope axis that the optical axes of its quartz plates lie parallel, being both perpendicular to the goniometer axis.

In adjustments with the compensator, the movable quartz wedge is first pushed far enough to make the half-prism show dark; it is then further pushed, first in one, afterwards in the other direction, until the field shows equal illumination. The mean of these two adjustments of the wedge gives the position of dark adjustment more accurately than if one attempted to get it by one position of the nicol.

Krüss Epidiascope.*—This instrument, which was described in this Journal,† and was invented rather more than a year ago, has lately been improved in certain details and adapted by A. Krüss to a greater range of purposes. Figs. 57 and 58 of the former abstract illustrate the principle, while the accompanying figs., 23, 24, show the new applications. Fig. 23 shows the epidiascope in normal adjustment. A self-regulating lamp for 30–50 amperes acts as the light-source. Transition from diascopic to epidiascopic projection is effected by pressure on one of

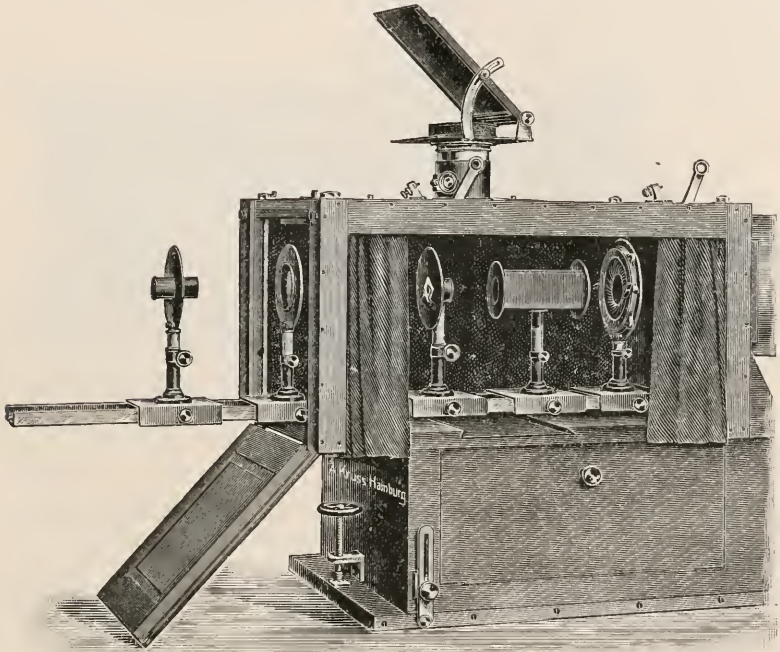

FIG. 24.

the levers seen in the figure. If both mirrors (S_1 S_4 original fig. 57) are thus put out of action and the front wall let down (fig. 24), the light-rays may then pass axially through the apparatus, and an optical bench may be inserted. Fig. 24 also shows the optical bench adapted for polarisation demonstrations. Suitable arrangements may be similarly made for exhibition of spectral, interference, and diffractive phenomena. A projection Microscope can be applied to the bench. Sometimes this Microscope objective would be equally suitable for the projection of opaque objects or of diapositives. But when considerable magnification is required, and increased distance from the screen is unattainable, the

* *Deutsch Mech.-Zeit.*, 1909, pp. 230–2 (3 figs.).

† See this Journal, 1909 p. 251.

arrangement shown in fig. 25 may be used with diapositives. This arrangement may, moreover, be used for the simultaneous projection of two diapositives, the front part being fitted with a specially large illuminating lens, which equally illuminates two adjacent diapositives adjustable in two mutually perpendicular directions. The diapositives may be independently exchanged.

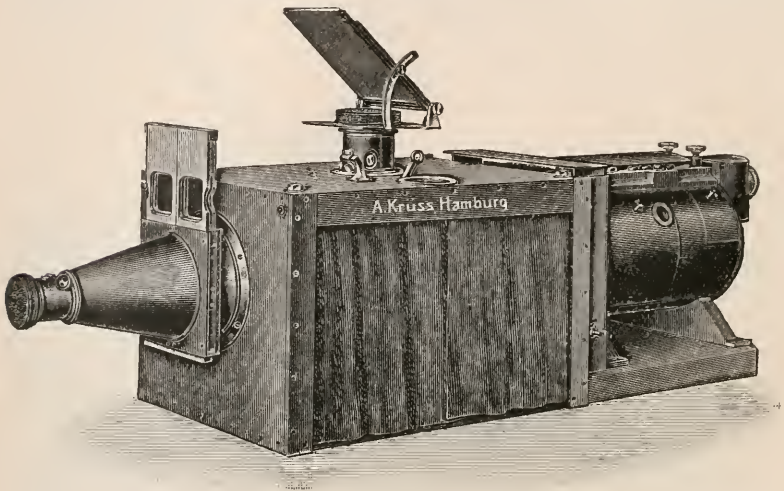

FIG. 25.

Application of Edinger's Drawing and Projection Apparatus to Macroscopic Photography.*—P. Martin has devised a stand which very much increases the usefulness of Edinger's apparatus.† The stand is manufactured by the firm of Leitz, and consists of a convenient framework in which a camera can be placed and clamped at any angle. This camera replaces the usual optical parts, and is capable, when adjusted at a suitable distance, of projecting into the ordinary photographic part images of very large objects. By this means the author has secured photographs of the pelvis of a horse, or even of an entire horse carcass. In the latter case the carcass was on the floor of a hall, and the frame was conveniently arranged in a gallery over. The frame is mounted on castors, and is therefore easily transferred to any desired spot, e.g. a patient's bedside. With an horizontal adjustment, an object on a wall, or vertical screen may be photographed.

Ocular Micrometer with Interior Vernier.‡—The firm of Nacet, under the instruction of F. Vlès, has manufactured an ocular micrometer which is intended to possess a precision equal to that of the best divided drum-micrometers, but with a less complicated mechanism. The read-

* Zeitschr. wiss. Mikrosk., xxvi. (1909) pp. 219-22 (2 figs.).

† See this Journal, 1905, p. 650, and 1891, p. 811.

‡ C.R. Soc. Biol. Paris, lxxvii. (1909) pp. 537-8.

ing, moreover, is within the Microscope, and therefore the time and inconvenience usually spent in reading an external graduation will be saved. The ocular has in its focal plane a scale divided on glass similar to ordinary micrometric oculars. In contact with this scale, and also in the ocular field, is a vernier divided into tenths, on the lower face of another glass slip gliding on that of the fixed scale. A simple metallic slide, a push-screw, and a back-spring suffice to move the vernier. The process of measurement will be easily understood, and takes place in the field of view. There are no special precautions to be taken, such as are usually necessary, with regard to errors of screw, of springs, or of carriers, in the case of external scales. Moreover, the measurement is made without taking one's eye from the ocular, and it is possible, in case of need, to dictate the readings to an assistant without the observer abandoning the observation of a fugitive phenomenon.

Watson and Sons' Holos Immersion Paraboloid.*—This apparatus (fig. 26) gives an intensely black background, with a brilliantly illuminated object, with high-power objectives up to 0.95 N.A., and is specially suited for showing unstained living bacteria. The makers supply full directions for the successful working of the apparatus.



FIG. 26.

Enumeration of Blood-corpuses.†—R. Samut advocates the use of the following simplified methods for counting blood-corpuses.

The enumeration of the formed elements of the blood, although admittedly of paramount importance in the diagnosis of disease, is not as frequently carried out as its value would call for. This is undoubtedly due to the fact that, in enumerating blood-corpuses by means of Gowers's or the Thoma-Zeiss haemocytometer, the chief difficulty encountered is the necessity of counting the large number of corpuses in each of the sixteen small squares which make up one of the large squares, since at least eight sets of sixteen small squares should be counted before a fairly accurate result can be expected. Moreover, corpuses often overlap the lines which form the squares, and great care is required and time lost to avoid counting them twice over.

By means of the Blenden ocular "Ehrlich" these difficulties are avoided. The construction of the ocular is as follows. An ordinary No. 2 ocular is provided with a screen which cuts out a square from the field of vision of the ocular. By means of the little knob (fig. 27) this square can be narrowed, and by means of notches, which divide one side of the square into four equal parts, the reduction may be effected in exact proportion (fig. 28).

Enumeration.—With this instrument enumeration of corpuses is done as follows. The drop of blood is obtained and diluted in the Thoma-Zeiss pipette and blown out on to the Thoma-Zeiss ruled slide in the usual way. When this has been placed on the Microscope, allow 5 minutes to elapse. Use a No. 9 Leitz objective and a Blenden ocular,

* Watson and Sons' Special Catalogue, 1910.

† Lancet (1909) ii. pp. 1424 (2 figs.).

the slit being so adjusted by means of the little knob that four squares of the central platform of the counting chamber just coincide with it. The number of red corpuscles are counted, and the preparation may now be shifted as many times as desired, each count representing the number of corpuscles in four squares, since the slit corresponds exactly to four of the squares. The total number obtained after several such counts being divided by the number of counts, gives the number of red corpuscles per

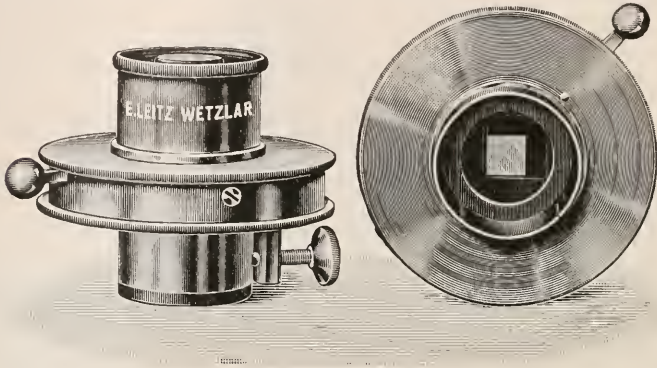

FIG. 27.

field of four squares; hence division by four gives the number per square. This number multiplied by 4000 would represent the number of corpuscles per cubic millimetre were it not that the dilution has to be taken into account, and accordingly the result must be multiplied by 100 or 200.

Example : Average number of red corpuscles per square = 10. Then $10 \times 4000 \times 100 = 4,000,000$ per cubic millimetre.

The method is quicker and more accurate than that usually employed,

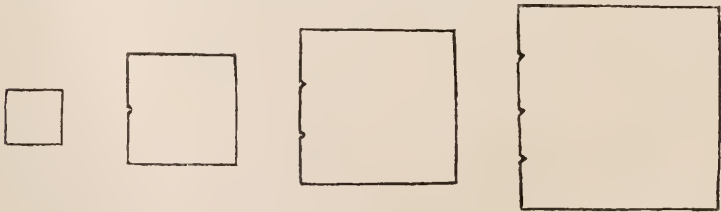

FIG. 28.

since it enables a much larger number of squares to be counted irrespective of the lines of the counting chamber, which constitute an element of confusion in the process of counting.

Again, the Blenden ocular may be used for the purpose of counting the leucocytes in the following manner. A dry-film preparation of the blood to be examined is fixed and stained by Leishman's or Jenner's stain. Using a No. 9 Leitz objective and a Blenden ocular, the number of red

and white corpuscles are counted, the shutter of the ocular being at one-half or one-quarter of the total field of vision. The count is made several times through the same slit, and an average of corpuscles per field is obtained.

$$\text{Now} \quad L : R :: l : r \quad \therefore L = \frac{Rl}{r}$$

where L represents the unknown number of leucocytes, R the known number of red corpuscles per cubic millimetre, and l and r represent the average of leucocytes and red corpuscles respectively per field of vision.

Pulfrich's Stereo-Komparator.—C. Pulfrich* has introduced an improvement into the above instrument, designed a few years ago,† which not only makes it better fitted for its original purpose, but also adapts it for photometric and spectrographic measurements, as well as for estimation of star magnitudes. In the earlier design the ray of light impinged on an inclined and semi-opaque film of silver (fig. 29),

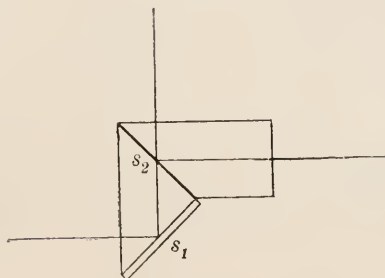

FIG. 29.

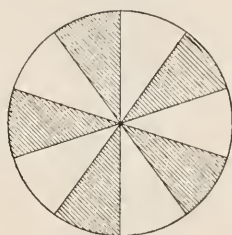

FIG. 30.

and was thus partly reflected and partly transmitted. It was found that the two images thus obtained, differed in intensity, thereby causing difficulties in experiments of comparison. The author has now replaced this silver film by a disk divided into ten sectors (fig. 30), five of which are opaque and five are transparent. He gives full details of the application of his design, which seems to have been highly successful.

ULBRICHT, R.—Zur Anwendung des Kugelphotometers und Zur Lichtschwerpunkt-Bestimmung. *Electrotech. Zeitschr.*, xxviii. (1907) p. 777; *Op. cit.*, xxx. (1909) p. 322.
See also *Zeit. f. Instrumentenk.*, xxix. (1909) pp. 353-6 (3 figs.).

(4) Photomicrography.

Method of Preparing Stereo-photomicrographs.‡—A. C. Banfield describes a method by which he has met with considerable success.

* *Zeit. f. Instrumentenk.*, xxx. (1910) pp. 1-6 (8 figs.).

† *Tom. cit.*, xxiv. (1904) pp. 161-6. See also this *Journal* (1904) p. 578.

‡ *Journ. Quekett Micr. Club*, 1909, pp. 459-64 (4 pls.).

The mathematical principle involved is that the interocular distance, normally 62 mm., has to be divided by the required magnification in order to give the angular separation through which the objective must be moved. Thus, for 32 diameters, the separation would be 2 mm.; and for 1000 diameters, 62 micra. In practice the photographic objective is kept still, and the object moved. The author uses two of Zeiss' optical benches, mounted on trestles. For very low magnifications (to about $\times 10$) one only is used; for higher magnifications they are placed end to end. At one end of the bench, fig. 31 (pl. III.), is fixed the lamp casing, the bench itself carrying the condensers, object-stage, lens and camera, all of them adjustable in any position on the bench. The camera itself is a very simple affair, adapted for the English standard stereoscopic size, $6\frac{3}{4} \times 34$ inches. The formula regarding objective separation resolves itself in practice into two parallel lines drawn on the focusing-screen, 62 mm. apart, by means of the stage. The object is moved until one of the lines cuts the image centrally: the first exposure is then made; the object is next transferred to the other line, when a second exposure will give the truly stereoscopic pair. The author uses Zeiss' "planar" photo-objectives, their very flat field making them especially suitable for this work; their aperture is, however, too low for high magnifications. Incident light seems to be more satisfactory than transmitted light. The Nernst electric lamp, with a one-ampere filament, makes an excellent light-source. Incandescent gas is also good, but requires long exposures. It is essential that each picture should have identical exposure. Arc-light involves a risk of burning a specimen, but only requires short exposures; it is a great help when dealing with autochromes, which have, however, special difficulties.

In the figure, B parallelises the rays; D is a long-focus lens for converging the parallel rays, after reflexion from mirror H, on the object O; E is a short-focus lens; F a plano-concave lens to parallelise the converging rays from E (this gives a parallel beam of small diameter, but of great intensity); G, object-stage, laterally adjustable by means of

EXPLANATION OF PLATE III.

- A. Lamp casing containing hand-feed arc lamp.
- B. Lens to parallelise rays from arc.
- C. Water-cooling chamber.
- D. Long-focus lens, converging the parallel rays, after reflecting from mirror H, on the object O.
- E. Short-focus lens.
- F. Plano-concave lens to parallelise the converging rays from E. This gives a parallel beam of small diameter, but of great intensity.
- G. Object stage laterally adjustable by means of the vertical pinion.
- H. Small mirror universally adjustable.
- I. 35 mm. lens (Zeiss Planar).
- J. Focusing pinion.
- K. Camera.
- L. Optical bench, on which the whole of the above is adjustable. The optical axis of the condensing system is 52 mm. above that of the camera. The horizontal line shows the course of the central ray of light. The condensers D and E are mounted on a hinged fitting, the one not in use being folded down out of the path of the rays.

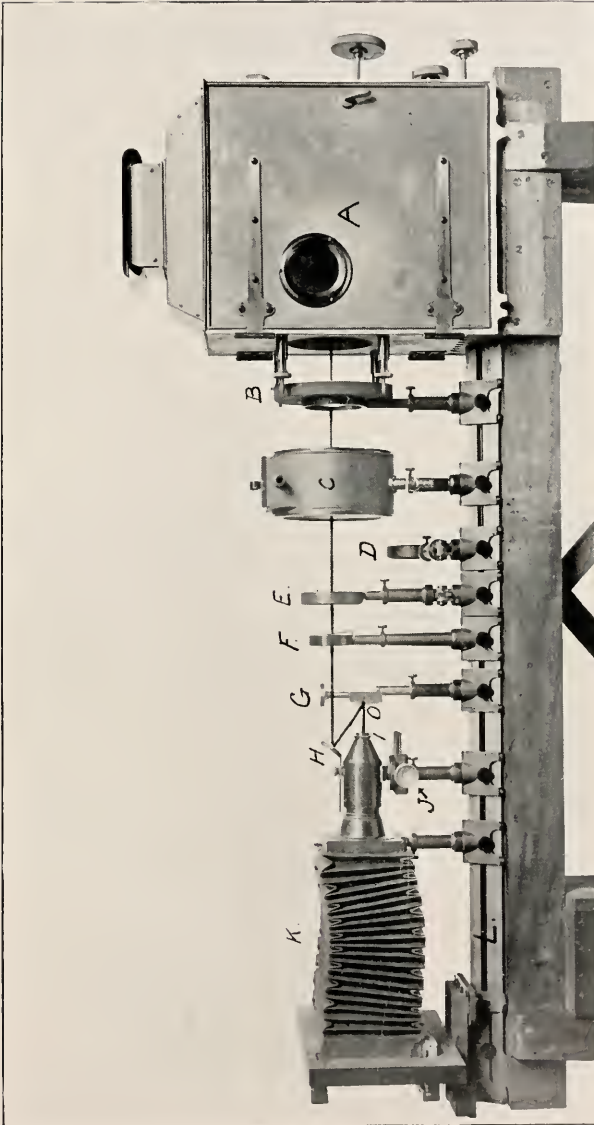

FIG. 31.—APPARATUS FOR STEREO-PHOTOMICROGRAPHY.

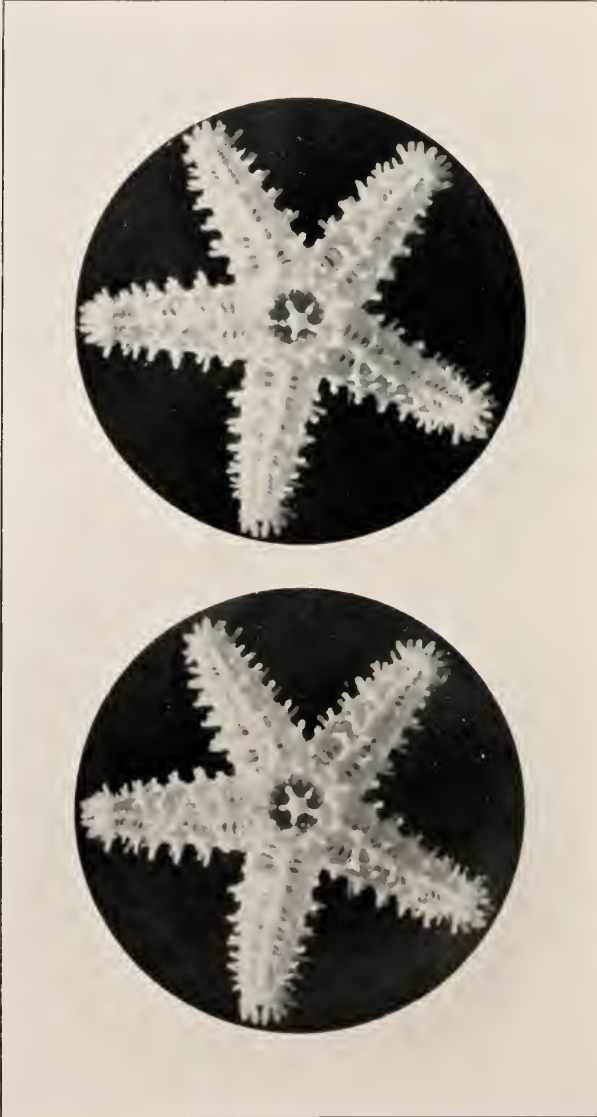

FIG. 32.—SKELETON OF YOUNG STARFISH (*Asterias glacialis*), $\times 7$.

the vertical pinion ; H, small mirror, universally adjustable ; I, 35 mm. lens (Zeiss planar).

The author gives several examples of his results, one of which is shown in fig. 32 (pl. IV.).

(5) **Microscopical Optics and Manipulation.**

Standard Measurement in Wave-lengths of Light.* — The principles underlying A. E. Tutton's method of interference measurements were described in the February number of this Journal, and a later description of the apparatus was promised.†

A general view of the interferometer and one of the duplicate Microscopes of the comparator, together with sufficient of the bar-carriage to enable some idea of the whole apparatus to be gained, is now given in the accompanying illustration (fig. 33), together with the author's description.

The whole instrument is mounted on a large stone block, resting on isolated concrete foundations. On a small stone pedestal, similarly isolated, in front of the large block, rests the pedestal of the auto-collimating telescope and attached Geissler tube of the interferometer. In the common focal plane of the telescope objective and eye-piece, opposite the junction of this main optical tube with the rectangularly attached side-tube carrying the Geissler tube, a small totally reflecting prism is arranged, half covering the focal aperture. A still smaller rectangular stop or opening in a plate in front of, and almost touching, that one of the perpendicular prism faces which is directed towards the objective, and lies in the focal plane very close to the edge, dividing the closed half from the open half, is the effective source of the interfering light ; the rays from the Geissler tube, received on the other face of the right-angled prism, are arranged to fill this stop after reflection from the hypotenuse of the prism. The rays proceed from the stop to the objective, which they are arranged to fill with light, and thence pass out of the telescope as parallel rays, in the path of which the dispersion and interference apparatus is placed. The rays return to the telescope from the latter along practically the same path, but after re-entering the telescope, instead of returning to the little rectangular stop, their origin, they are deflected just sufficiently to one side to form an image of the stop, the same size as the original, in the open semicircular aperture of the focal plane, within a couple of millimetres of the real stop. This closeness to identity of path of the outgoing and incoming rays, and consequently normal incidence on the reflecting glass surfaces of the interference apparatus, is largely responsible for the magnificent field of parallel straight-lined interference bands which the author's interferometer affords, for it fulfils an essential condition for perfect interference.

With the ordinary eye-piece in position, the images of the stop reflected from the various surfaces of the interference apparatus can be focused, adequately magnified, and viewed during their adjustment to

* See this Journal, 1910, pp. 107-8.

† Tom. cit., p. 107 ; Phil. Trans. A, ccx. (1910) p. 1 ; Nature, lxxxii. (1910) pp. 338-41 (1 fig.).

the theoretically ideal positions. But when this eye-piece is replaced by a special one consisting of a Ramsden micrometer, combined with an

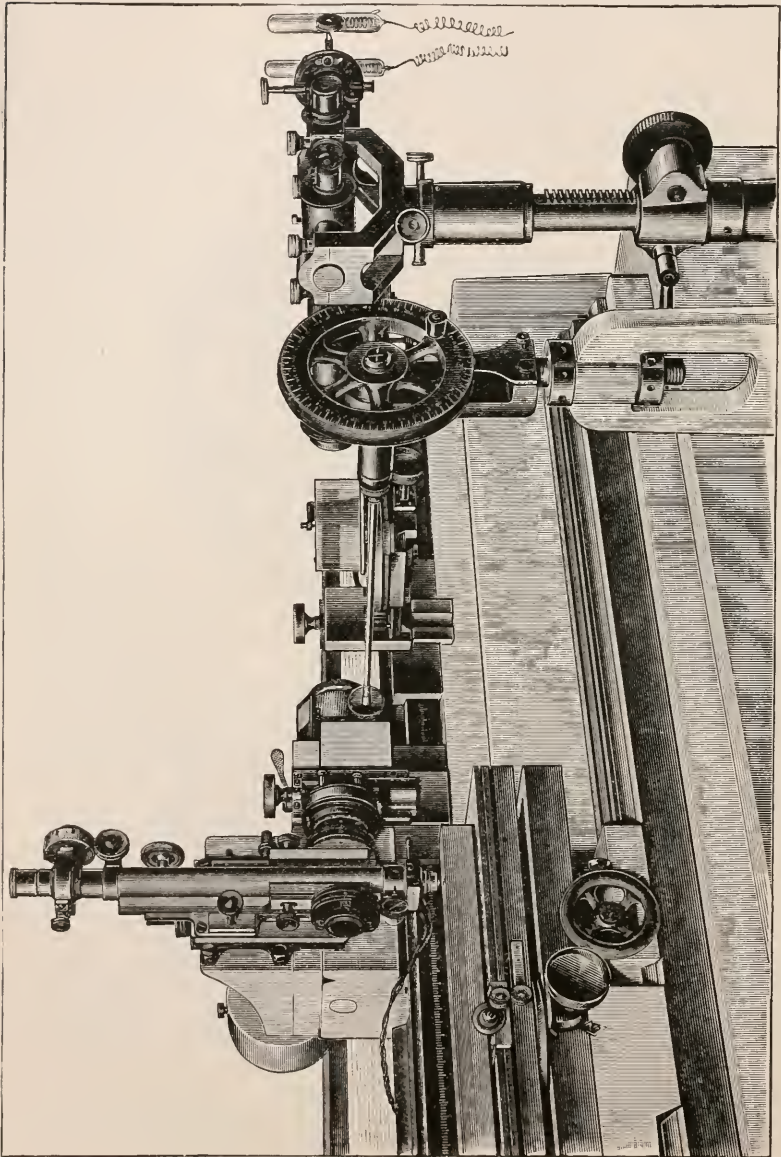

FIG. 33.

additional lens between the latter and the focal plane, the telescope is converted into a low-power Microscope, which focuses simultaneously

the interference bands, a little silvered reference ring in the centre of one of the two surfaces reflecting the interfering light, and the micrometer spider-lines. There are two parallel vertical spider-lines; one is adjustable by the left drum-head of the micrometer, so as to be able to set it at any convenient distance from the other in order to include a single band and most of the reference ring between them; and both are moved together by the other (right) measuring drum, in order to be able to determine the band-width and any fraction of a band which may have passed the reference centre.

The dispersion apparatus consists of a Hilger constant-deviation prism, which enables the desired spectrum ray to be isolated from all others, and that alone delivered to the interference apparatus. The rays are deviated exactly at right angles by this prism towards the interference apparatus, the surfaces of which they strike at normal incidence, after which they return through the constant-deviation prism (thus securing double dispersion) to the telescope. The prism is mounted on a divided circle, so that it may be calibrated for the delivery of light of any desired wave-length, if desired, and has numerous adjustments. Such calibration is not essential, however, as the particular image of the origin-stop in the colour corresponding to the spectrum bright line of cadmium or hydrogen can be adjusted visually on removal of the front lenses of the Ramsden eye-piece.

The interference apparatus consists of three circular and thick glass disks, the third of which is of black glass polished an absolutely true plane on its outer surface, which is one of the two important surfaces concerned in the production of the interfering light. It is ground on the back surface, by which it is attached in an adjustable manner to the right Microscope of the comparator, the movement of which it is to record. The outer two are larger disks of colourless glass, identically similar, the two truly plane surfaces of each disk not being strictly parallel, but inclined at the minute angle of $35'$. The left surface of that one nearest to the black glass disk is the second surface concerned in the interference, and approaches the black glass within a millimetre; the second is a duplicate one, merely introduced on the right of it to correct for the slight dispersion produced by the $35'$ of inclination, the two being set oppositely as regards the direction of the wedge. The $35'$ inclination is just adequate to deflect out of the field of the telescope the reflection from the other (right) surface of the left colourless disk, and both images from the countervailing disk are got rid of by a slight tilt in the rectangular direction. All the many adjustments required are provided for in the mounting of the two colourless disks on a separate carrier sliding along the face of the upper V-and-plane bed of the comparator.

The apparatus, as described up to this point, is the interferometer.

The comparator consists of two V-and-plane beds, nearly 7 ft. long, of specially homogeneous cast-iron, and worked truly plane with consummate care, together with their contents; they are arranged step-wise, one on the top of the stone block, and the other $7\frac{1}{2}$ in. below and in front. On the upper one slide the two duplicate Microscopes, and on the lower one the standard-bar carriage and accessory fine-adjustment fittings. The carriage is given a longitudinal motion, a transverse

motion adequate to bring either of the two bars to be compared under the Microscopes, as well as fine-adjustments for azimuth, height, and level, thus enabling the defining marks on the bars to be readily focused without touching the Microscopes if it is so desired.

Each Microscope is carried on a solidly constructed slider on the V-and-plane bed, by which its coarse-adjustment for position is effected. The microscope-bearing bracket is not, however, fixed directly to this slider, but to a second one sliding over the first, also with V-and-plane contact, and with the further control of the movement of a cylinder within a cylindrical boring. The fine-sliding is effected by means of a most carefully made screw of fifty threads to the inch, on which the success of the instrument depends, and which carries at its outer end a large milled head for hand rotation, and a worm-wheel of 100 teeth gearing with an endless screw, which can either be rotated by hand by means of a milled head or by means of a shaft and a large wheel, seen in front in the illustration. One complete rotation of the latter corresponds to the movement of the Microscope and the black glass interference disk to an extent which causes the passage of fifteen interference bands past the reference centre. More than an inch of movement of the circumference of the wheel is necessary to effect the passage of a single band. Two-thirds of the dead-weight of the Microscope and slider are taken up by four spring pistons, and the movement of the slider by the screw is only a push in either direction against the walls of a recess in the free slider, there being absolutely no strain anywhere. Hence this movement of the Microscope is not only an excessively fine one, but also so steady that the bands pass with a precision which leaves nothing to be desired, and each band may be held for any length of time for counting purposes.

Each Microscope is provided with a micrometer eye-piece, with spider-lines arranged as in the interferometer. The fine-adjustment is made exceptionally steady and regular. Two sets of objectives are provided, one pair for observing the defining lines in the countersunk wells near the ends of standard bars, with a magnification of 150 diameters, and without penetration of the well by the objective, and the other set for use with the wave-length rulings.

The defining lines, of whatever character, are illuminated (with "critical illumination") by the brilliant image of a distant Nernst lamp, with the aid in each case of a little reflecting prism, a collimating lens, an iris diaphragm, and a glass-plate mirror above the objective, all provided with fine-adjustments. This avoids all heating effect on the bars, and the last traces of heat rays are filtered out by a thick water-jacket in front of the lamp and its beam-parallelising lenses. The illumination of the wave-length rulings $\frac{1}{40000}$ in. apart is excellent with the $\frac{1}{2}$ in. dry objectives employed, and the definition truly surprising.

The temperature of the whole comparator room is maintained at the official temperature, 62° F., entirely electrically, both as regards artificial heating and the thermostat, which is original. So sensitive is the latter that the entrance of a person into the room is immediately followed by the extinction of one of the heating lamps to compensate for the extra warmth introduced.

The finest defining lines yet employed on any line-measure bars are

those on the platinum-iridium copy of the imperial standard yard. Yet even each of these has a thickness equivalent to fifteen interference bands. The defining lines on the imperial yard itself are three times as coarse. Hence we have now arrived at that stage in the competition between defining lines and refinement of measurement when the latter has far surpassed the former. It was for this reason that the author took up the investigation of wave-length rulings, with the idea of their possible use as defining lines commensurable with the increased refinement of measurement. Mr. H. J. Grayson, of Melbourne, whose wonderfully fine rulings have recently been much discussed in microscopic circles, has kindly made a number of rulings of $\frac{1}{40000}$ in. fineness, which preliminary experiments indicated as feasible for the required purpose, on polished speculum-metal and platinum-iridium, which appear, particularly the former, perfectly satisfactory. The $\frac{1}{40000}$ in. being the wave-length of red hydrogen or cadmium light, the distance between two lines ruled at this interval corresponds to only two interference bands. With the $\frac{1}{2}$ in. dry objectives, the lines, moreover, are as cleanly cut as spider-lines, and the thickness of a line is less than half a wave-length. Five such lines are ruled in succession, the central one being considered as *the* defining line. A strong finder-line is ruled on each side of the five, and two other strong ones at right angles in order to localise a central part of such a system. It appears perfectly feasible to carry out a stepping-off process for the counting of the total number of wave-lengths of cadmium red light in the British yard, in which such rulings would take the place of the glass plates of the Michelson or Fabry and Perot *étalons*, a base line of the thirty-second part of an inch being first actually counted in bands with the aid of the interferometer, between limits defined by two such systems of rulings. The final fraction of every stage in such a process could be absolutely checked by the interferometer in all cases where Michelson found it possible to do so, that is, so far as interference bands are still visible, about 4 in.; and, as it has already been proved that the accuracy with the rulings is almost as great as with interference bands, this checking ceases to be as imperative as when only the coarse existing defining lines are available. Hence, the future before these rulings appears likely to be both interesting and important.

On the Production of Micrometric and Diffraction Rulings.*

Henry J. Grayson says: Some years ago I had occasion to use some finely-ruled glass plates, not exceeding 0.01 in. thickness, the lines upon them ranging from 0.02 in. to 0.004 in. apart. These, I found, were not readily obtainable commercially, so that I had to devise some method of producing them for myself. After a few experiments, I soon found I had no difficulty in ruling lines greatly exceeding in fineness and accuracy any of the kind I had hitherto seen, and, as the matter was interesting to me from a microscopical standpoint, I pursued it apart from my immediate requirements.

The apparatus I first devised and used was exceedingly simple in principle, and consisted essentially of a fine steel screw and wedge of glass, the incline of the latter bearing some definite ratio to the pitch of

* The Microscope, i. (1909) pp. 4-11.

the former. This glass wedge travelled along a bed, or base-plate, also of glass, being kept in position by means of a slot cut along its surface. As the wedge was propelled forward by the screw it raised a vertical plate, accurately adjusted at right angles to the base-plate, and as free as possible from movement other than that imparted to it by the wedge. To this vertical plate, the slide, or disk to be ruled upon, was attached by means of a suitable cement. A platform, for the support of a sliding diamond carriage, bridged the base-plate and wedge at a suitable height, being, of course, arranged transversely to and in front of the vertical slide.

With this roughly constructed apparatus I was able to produce ruled bands, or groups of lines, ranging from 5000 up to 50,000 lines per inch. The apparatus has since been completely rebuilt, being variously modified and altered in accordance with experience gained, and the greater precision demanded by the class of work subsequently undertaken.

My work has tended mainly in the direction of perfecting rulings for micrometric measurements, and for test purposes. To accomplish this, I have had so to modify and improve the apparatus with which I first commenced work, as to render it capable of precise and accurate movements much less than 0.00001 in.; also to select and mount diamonds with knife edges of a fineness or keenness equal to the grouping together of lines less than 0.00001 in. apart, and yet of such strength and durability as to be capable of producing many thousands of such lines without material alteration in character; and, last, but by no means least, so to mount these rulings as to exhibit them in the best possible manner, while at the same time insuring their permanence as microscopical preparations.

The selection, setting and cutting action of the diamond are of the utmost importance. Nearly all the stones I have used have been obtained from Bingara, N.S.W.

I have tried Brazilian and West Indian diamonds, also the black diamond or carbonado, none of which appear to possess any advantage over those obtained from New South Wales. Some little time ago I received from Dr. van Heurck, of Antwerp, two stones which had been specially prepared after the method of Nobert, by one of the most skilful diamond workers in that city, neither of which was of any value, the cutting edges being much too blunt for fine work. My own method of preparation is to carefully break the stones so as to insure fracture parallel with some of the numerous cleavage planes. The fragments so obtained are examined under the Microscope as to the perfection or otherwise of the angles or edges and faces forming them, the promising pieces being put aside for trial. Good results have also been obtained with stones upon which large facets had been ground on the outer or natural face and afterwards broken so that one face of the knife edge was artificially formed, while the other followed the line of cleavage. Excellent cutting angles have been obtained, too, in the case of stones one face of which forms the outer coating, or skin as it is termed, of the uncut gem.

I always set or mount the diamond so that its cutting edge is perfectly parallel with the line to be cut, and slightly raised in the

direction in which it is to travel. This is contrary to what one would expect, comparing the action of a diamond with a steel graver or other cutting instrument for like purposes, but when it is remembered that the faces, the junction of which form the cutting edge, wear more rapidly than the edge itself, one sees the analogy no longer holds good. In the setting and adjustment of the diamonds it is important to remember that, in the case of test rulings at any rate, the lines after being ruled must on no account be rubbed or polished, consequently, the material removed must be deposited on one side or the other of the groove formed, and this involves the utmost nicety of adjustment of the cutting edge, and not infrequently is a considerable tax upon one's time and patience. The finer the ruling, the greater is the importance to be attached to this particular feature. The length of the cutting edge is also of moment. The longer the edge within certain limits, soon ascertained by experience, and providing it is perfectly straight, the longer will it endure, but as depth and breadth of line are important factors, too long an edge implies too great a pressure strain to produce a line of given depth and width. The pressure upon the diamond to produce a line of a certain depth and breadth, I apply, in the case of micrometric rulings, by means of a spring controlled by a screw; this gives good results up to a rate of 20,000 lines per inch, but beyond this the friction involved is detrimental. The variation of pressure requisite in test plate ruling is obtained by means of a series of weights ranging from 20 grm. or more down to a fraction of 1 grm.

In the matter of spacing, it is of the utmost importance that a correct standard should be obtained as a basis for all micrometric measurements. At the outset, I obtained copies of portions of the standards in use at the Melbourne Observatory, both metrical and English inch values. On carefully examining these I found a slight discrepancy between the inch scale, as copied directly from the standard, and the same values obtained by computation and ruling from the metrical standard. As I had no means of determining which of the two scales was more likely to be correct, I adopted the metrical scale as it stood as my standard for metrical values, and the inch values, as copied from the standard inch scale, as a standard for fractional values of an inch. At a later date I submitted several micrometer rulings to Mr. E. M. Nelson, a recognised authority upon all matters connected with measurements of this character, with the result that it was found that the ratio of inch to millimetre was, in the case of my inch rulings, 25.3821 instead of 25.39997; but as the metrical values proved to be correct, in comparison with the best standards, I have since adopted this scale as a basis for both systems. It may be of interest to know how I determine that lines stated to be ruled, say, at the rate of 90,000 per inch, are really of that value. For this it is only necessary to adjust the relationship of the wedge to the screw once for all, so that forty revolutions of the latter give a movement equal to 0.02 in., in which case one revolution will equal 0.0005 in. As the error in forty revolutions can easily be brought within $\frac{1}{50000}$ in., the error in $\frac{1}{40}$ of this is a negligible quantity. The screw-head being divided into 360 degrees reading by a vernier to $\frac{1}{10}$ of a degree, 8 degrees of movement of the screw-head advance the plate being ruled the $\frac{1}{50000}$ part of an inch,

and so, proportionately, for other values up to 120,000 lines per inch, the finest I have ruled which have so far been resolved. In passing, I may state that the finest lines it has been possible to resolve or separate, by means of the most perfect microscopical appliances hitherto constructed by the best makers, have not exceeded 120,000 per inch.

I have yet said nothing concerning the glass most suitable for ruling upon. Ordinarily the outer crust or surface of the glass as it leaves the makers' hands is much too hard and brittle for the purpose, and speedily ruins the hardest diamonds. This is especially so in the case of thin unannealed microscopical cover-glass, which it is essential to use for many purposes. Hence it occurred to me that it might be possible to so modify and alter the surface of this glass by a process of annealing that better results would be obtained. After some few trials I found that by inclosing a carefully cleaned cover-glass in a metal capsule, and slowly heating to a certain point, short of actual softening, and allowing the cooling process to extend over as long a period as possible, the glass proved to be both softer and tougher, and at the same time far less liable to any alteration due to changes in temperature, or the relief of certain surface strains inherent to the glass in its unannealed condition.

I pass on now to a matter of equal importance with any hitherto dealt with, viz., the preservation of the completed rulings. Ordinarily in the case of micrometer rulings varying from 1 mm. to 0.01 mm. all that is necessary is to fill the lines with graphite, and mount the cover on a slip with Canada balsam. But this method is not suited to the finer rulings, or where it is desirable to preserve the lines without the graphite filling, as in the case of test plates. Nor is it possible to preserve them by attaching the cover-glass to a cell wall or ring of cement or wax, as is frequently done with other microscopical preparations. I myself tried every, or almost every, known cement and wax cell at all suited to the purpose, and in every instance it was only a question of time, probably a year or more, and the cover-glass became coated or covered with minute crystals in some instances, or microscopical beads of moisture in others, to such an extent as to detract greatly from the beauty and perfection of the lines, and in some cases to partially obliterate the finer bands altogether. It therefore remained for me to endeavour to mount the ruled plates in a medium possessing a refractive index differing from glass by an amount equal to the difference between glass and air. Several such media existed, and had been used for other purposes, but with only partial success. These were phosphorus, sulphur, and realgar, or arsenic disulphide. The latter appeared to me the most promising substance to work with, seeing it possesses a refractive index equal to 2.549, but its use is attended with many difficulties, and I worked with it for nearly a year with only partial success. I soon abandoned all attempts to use it in a liquid form dissolved in the usual solvent, bromine, which I found both uncertain and dangerous to use, and turned my attention to the production of thin films, by sublimation. With these I was more successful, and after a time was able to produce exceedingly thin films, which have so far proved quite permanent. Some of the films here shown have been mounted over two years, while those sent to London some little time ago withstood all the

changes of temperature to which they were subjected on the journey without showing any signs of depreciation.

Measurement of the Refraction Index of Liquids by the Microscope.*—M. L. Décombe's method is based on that of Brewster, but is much more precise. The method requires a glass plate with parallel faces L, and a plano-convex lens resting on the plate (fig. 34). A drop of the liquid to be studied is placed at O, between the plate and the lens. A is a luminous point. By the help of a Microscope, the positions of the images O' and A' are determined, being (1) the distance from O the point of contact of plate and lens; and (2), the distance from the luminous point A. If Δ be the displacement of the Microscope, and ν the index of the liquid, it follows that

$$\nu = A - \frac{B}{\Delta}$$

where A and B are two positive constants which, in the special case when A is at infinity, have for their respective values $A = N$, $B = R$; N and R expressing respectively the index and the curvature-radii of the lens. The coefficient $A = N$ must be previously determined by goniometric methods; then B can be calculated, if ν for a known liquid be taken.

The point O', being independent of the imperfections of the plate L, of the aberrations of the curved surface and of the nature and opacity of the liquid, can be determined with great accuracy, and can be ascertained, once for all, at the outset of each series of observations. Precision depends particularly on B; but the author's experiments show that in monochromatic light the error can be easily rendered less than 0.001.

To get the second point as accurately as possible, a liquid biconcave meniscus should be employed—i.e. the liquid should be interposed between two convex glasses in contact at their summits, the radii of curvature being chosen in such a manner as to reduce to a minimum the mean spherical aberrations.

In the author's experiments a cross lightly traced with a diamond on the plate L served as a net for the first point. Various precautions had to be taken, and these are described in the treatise. A Monpillard screen giving green light sensibly monochromatic, was used. When the adjustments have been made, and the constants obtained, it will be noticed that the method requires only a single drop of the liquid; and that also the extreme tenuity of the layer is serviceable for translucent fluids; and that the small volume removes difficulties as to temperature.

Pleochroic Halos.†—F. P. Mennell draws attention to the special interest attaching to this subject, since Professor Joly's suggestion that they are due to the radio-activity of the inclusions round which they

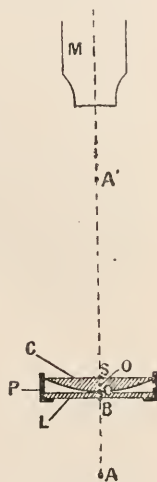

FIG. 34.

* Comptes Rendus, cl. (1910) pp. 389-91 (1 fig.).

† Geolog. Mag., vii. (1910) pp. 15-19 (1 pl.).

occur. The usual type of halo, as seen in rock sections, is a dark spot of roughly circular outline surrounding a small centrally situated inclusion in another mineral which itself may, or may not, also be pleochroic. The author has found that the following minerals usually show halos:—Beotite, augite, hornblende, muscovite, chlorite, tourmaline, cordierite, staurolite, and andalusite. There is sometimes a difficulty in the identification of the mineral producing the halo, but the author has detected zircon, sphene, apatite, orthite (allanite), and epidote. All these latter minerals (except, perhaps, epidote) are well known to be, comparatively speaking, strongly radio-active. As far as the rocks are concerned, halos are far more common in those of igneous origin than in the other classes, and are especially noticeable in the plutonic types, particularly the granites. The halos are usually spherical in shape, but irregular grains, or granular aggregates, produce halos of corresponding shape, the coloured margins being, however, of uniform width. This uniformity of width is a remarkable feature, the measurement of a large number of cases giving few variations from 0.03 mm. Professor Joly has pointed out that the penetration of the α rays emitted by radium compounds is about 0.04 mm. in the case of aluminium, and, having regard to the slightly greater density of the minerals examined, the results are in close agreement with the theory that the halos are due to the alteration of the surrounding minerals by these rays.

(6) Miscellaneous.

Homogeneity of Optical Glass.*—W. Zschokke points out the difficulties in producing homogeneous glass. The importance of the subject needs no demonstration, but the attainment of homogeneity seems impossible. Even the best compounded and cooled glass-meltings vary considerably in their refractive index. The variation would be less important if the manufacturer had only to make a single lens, but his task is more frequently the manufacture of compound lenses and of reproductions. As a means of testing want of homogeneity, the author suggests the cutting of a right-angled prism from a given slab. By telescopic observations on an “infinitely” distant object seen through the prism, the refractive index can be calculated for different parts of the prism. The knowledge thus obtained may be useful in selecting a suitable part for lens manufacture.

Spiers’ “Nature through the Microscope.” †—This work, the subtitle of which is “The Rambles and Studies of a Microscopist,” is a popular account of some of the better-known “Marvels of the Microscope.” It is written in language as simple as the subject-matter permits, and the descriptions convey as much information as a quite uninstructed observer may be expected to assimilate. It is designed primarily to interest such an observer in the Microscope and its revelations, and also to assist a beginner in the choice and use of an instrument. The volume is copiously and satisfactorily illustrated.

* Zeit. f. Instrumentenk., xxix. (1909) pp. 286-9 (1 fig.).

† London: Culley (undated) 335 pp. (10 col. pls. and about 300 drawings).

Quekett Microscopical Club.—The 461st Ordinary Meeting of the Club was held on December 28, 1909, the President, Professor E. A. Minchin, M.A. F.Z.S., in the Chair. Mr. R. T. Lewis, F.R.M.S., gave an interesting account of "The Pollination of the Asclepiads." His attention had been drawn to the subject by the finding of dried pollen-sacs of one of this genus firmly attached to the feet of some insect specimens received from Lindley, O.R.C. A reference to Kerner and Oliver's "Vegetable Kingdom, ii. pp. 257-9, was given.

The 462nd Ordinary Meeting was held on January 25, 1910, the President in the Chair. Mr. James Murray, one of the scientific staff on board the 'Nimrod,' gave an interesting account of the aquatic organisms taken in the Antarctic by Lieut. Shackleton's expedition. Preparations by Mr. Rousselet from material brought home by the expedition were shown of *Philodina gregaria*, which occurred in great abundance; *P. alata*, remarkable for its large lateral processes; *Adinetu grandis* sp. n., from Ross Island; and *Hydatina senta*.

At the 44th Annual General Meeting, held on February 22, the President, Professor E. A. Minchin, M.A. F.Z.S., delivered the annual address, taking for his subject, "Some Considerations on the Phenomena of Parasitism amongst Protozoa." In the sense under discussion a Protozoan is a parasite when it lives at the expense of another animal, called its "host." Such parasites may live on the host (epizoic) or in it (entozoic). Both these classes may be further divided into non-lethal (harmless) and lethal, or disease-producing, species. The lethal powers of the latter class are most probably due to specific toxic effects produced by them. Lethal species may be regarded as exceptional and aberrant forms, the majority of Protozoan parasites being harmless. After dealing briefly with the few known cases of active migration of parasites to infect a new host, the special methods of dissemination, of which at least six are known, where the escape of the parasite by anatomical channels is not possible, were described at some length. Sir E. Ray Lankester had suggested that the extinction of animals seen in past geological periods may have been due, in some cases, to their extirpation by some species of parasite new to them, and consequently very deadly. In proposing a vote of thanks to the President, the Chairman, Mr. C. F. Rousselet, F.R.M.S., said that when recently in Canada he had heard it suggested that the extinction of the vast herds of buffalo was caused by some peculiar parasitic malady.

B. Technique.*

(1) Collecting Objects, including Culture Processes.

Cultivation of Leishmania Donovanii in Fluid Media. † — A. Laveran and A. Pettit use a peptone-salt medium, which is distributed in Roux's flasks and then sterilised. Into each is poured an equal quantity of defibrinated rabbit-blood. As the cultures are only successful when there is a thin layer of liquid, the flasks are laid flat in the incubator, which is regulated for 21-22° C. The quantity of

* This subdivision contains (1) Collecting Objects, including Culture Processes; (2) Preparing Objects; (3) Cutting, including Imbedding and Microtomes; (4) Staining and Injecting; (5) Mounting, including slides, preservative fluids, etc.; (6) Miscellaneous.

† C.R. Soc. Biol. Paris, lxxviii. (1910) pp. 114-15.

liquid should not exceed one-tenth of the total capacity of the flask. In three or four days growth is evident; in a week the colonies are visible to the naked eye.

Use of Magnesium in Stupefying Marine Animals.*—A. G. Mayer finds that marine animals can be anaesthetized much more rapidly if placed in an aqueous solution of $MgSO_4$ or $MgCl_2$ of three-eighths molecular concentration. They then subside into complete relaxation, and after an hour or two may be killed in any way without becoming distorted through contraction. The method has been tried with marked success, and seems specially suitable for stupefying highly sensitive and contractile animals.

Method of Examining Embryos from the Maternal Tissues of the Rat.†—V. Widakowich, in a contribution to the study of the embryology of the rat, gives an account of his method of obtaining embryos and ova from the uterus and Fallopian tubes of the female rat. In some cases he examined specimens extracted from the maternal organs; in other cases, he prepared specimens of the tubes or the uterus with the contained embryo and examined the tissues by means of serial sections. Zenker's fluid and Schaffer's formalin-alcohol were the most satisfactory fixing fluids. Sublimate-alcohol was tried, but made the specimens very brittle.

For imbedding such objects as Fallopian tubes containing ova, or the uterus containing an embryo, the ordinary celloidin and paraffin-methods were unsatisfactory. A combined celloidin-paraffin method gave good results. The material was soaked in 4 p.c. celloidin and then exposed to chloroform vapour. When the celloidin became solid, the block was immersed in benzol and then imbedded in paraffin with a melting-point of $58^\circ C$.

Studying New Sporozoon in Rat-fever.‡—From the blood and lymphatic glands of two individuals suffering from rat-fever—rat-bite disease—M. Ogata has obtained sporozoa, to which he has given the name *Sporozoa Muris*. They appear to belong to the Neosporidia. Inoculation of material from the ulcers, blood, or lymphatic glands of the patient into rabbits and guinea-pigs causes the death of these animals in from one to three months. From their blood, sporozoa in various stages of development may be recovered.

New Hot-water Funnel.§—Many of the present funnels for filtering agar and other fluids at a high temperature, prove unsatisfactory in use. V. Brudny describes an improved apparatus (fig. 35), free from the disadvantages of the older types. It consists of a copper vessel in the shape of an hour-glass. The lower truncated cone contains water, maintained at a constant level by means of the small side-chamber provided with supply and overflow tubes. The water is heated by means of a Bunsen ring, which is fixed to one leg of the tripod stand

* Biol. Bull., xvii. (1909) pp. 341-2.

† Zeitschr. wiss. Zool., xciv. (1909) pp. 242-7.

‡ Mitt. Med. Fakul. K.-Jap. Univ., viii. 3 (1909) pp. 287-318.

§ Zeitschr. wiss. Mikrosk., xxvi. (1909) pp. 418-21.

on which the apparatus rests. The steam rises into the upper inverted cone, in the hollow of which rests the glass filter funnel. The inner wall of this hollow cone is perforated to permit of the escape of the steam and its access to the outside of the glass funnel. Any condensation water trickles down into the receptacle below, seen in the hollow of the Bunsen ring.

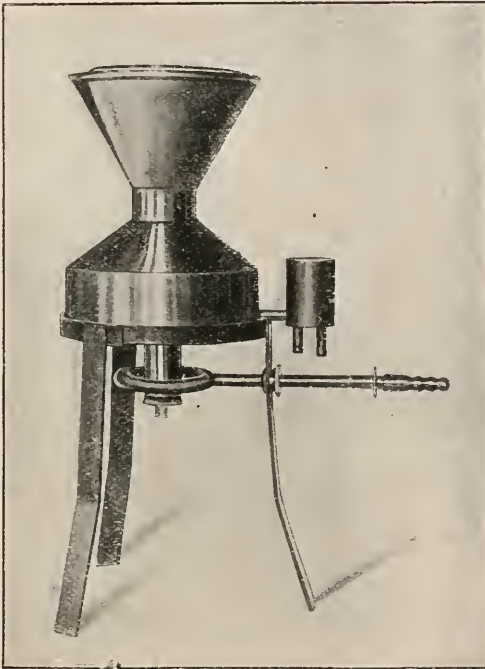

FIG. 35.

Examination of the Blood for Trypanosomes, etc.*—C. Levaditi and V. Stanesco have utilised the hæmagglutinating property of ricin to facilitate searching in the blood for trypanosomes, spirilla, and the like. They take small centrifuge tubes and place 4 c.cm. of the solution of ricin in each tube. The tubes are then sealed and sterilised. When required for use, a tube is opened and 20–30 drops of blood introduced. Agglutination begins at once, and is completed in a few minutes. When all the globules have fallen to the bottom, the supernatant fluid is decanted and centrifuged. The supernatant fluid is again centrifuged, leaving a drop to dilute the sediment. This is then pipetted off, and may be examined fresh or stained with Giemsa. In the

* C.R. Soc. Biol. Paris, lxxvii. (1909) (1909) pp. 594–6.

authors' hands this method has greatly simplified the detection of these parasites.

Glycerin-agar in Fifty Minutes.*—R. G. Perkins describes the following method for the easy and rapid making of glycerin-agar. The materials used are agar 12 gm., peptone 10 gm., salt 5 gm., and Liebig's extract $2\frac{1}{2}$ gm. Witte's peptone and Liebig's extract appear to be necessary, as the results are less good with others.

Weigh an enamelled pan, preferably one with a double copper bottom, as this reduces the chances of burning, with 1200 c.cm. of distilled water, and record the weight. Place on the gas stove while weighing the other materials, with about 150 c.cm. of additional water to allow for evaporation. This is an important part of the process, as it makes a greater dilution for the first solution of the materials. Add all the materials at once and boil till the whole is in solution, which should be in less than 15 minutes. Cool to 60° C. by the addition of enough cold distilled water to keep the total weight up to about 150 gm. over the sum of the pan, 1200 c.cm. water and the agar, etc. Make faintly alkaline to litmus, and add the whites only of two *absolutely fresh* eggs, beaten up in a little water. Boil, not too vigorously, until the medium boils up clear, and the egg is completely coagulated. The weight at this point should be the sum of the pan, the 1200 c.cm. of water, and about 50 gm. for the added materials. Skim and pour into wire funnels with filters of Schleicher and Schull No. 580, which have just had boiling water poured over them. The funnels are of the type which can be bought with a rubber ring at the top for compression, but I have found them more satisfactory when the top ring is of wire with the rays soldered to it. The filter paper need not be creased, nor an outside funnel used, accidents being very rare. If the room is moderately warm, filtration takes place in a few minutes, usually not requiring more than one sheet of paper divided into fourths. As soon as the filtration becomes slow repeat with a fresh piece of paper, the residual medium being reheated to the boiling point, and boiling water being poured into the paper before the introduction of the agar. As soon as the first 500 c.cm. have come through, it is the custom for the students to add the glycerin or dextrose, etc., and to tube the media while the rest is coming through. From the time that the first weighing is begun until the time when the filled tubes are placed in the sterilizer need not be over 50 minutes, and the students, even the first time, accomplish it in an hour and a half.

The resultant medium is transparent, almost colourless, unless it has been burnt, when it will have a yellow colour. No difficulty has been found in growing the ordinary strains of streptococcus, diphtheria or tuberculosis, and a large proportion of pneumococcus cultures show good development. The medium is firm enough for satisfactory plating, and has adequate water of condensation.

The use of distilled water is important, as also the special grade of filter paper, but the most essential points are the excess of water during the process, the absolute freshness of the eggs, and the preservation of filter paper and media at the boiling point until they meet.

* Johns Hopkins Hosp. Bull. xx. pp, 324-5.

(2) Preparing Objects.

Improved Method of Dehydration.*—B. Suzuki considers that the ordinary method of dehydration, by which objects are placed successively in 50, 70, and 90 p.c. alcohols, is unsuitable for delicate objects, and describes an apparatus (fig. 36) by which the concentration of alcohol is increased gradually. G_1 and G_2 are filled with distilled water; the inverted flask K is filled with 50 p.c. alcohol. The material M is placed in G_2 , resting on washed sand S. The junction tube W is filled with glass-wool. As water trickles away through the capillary tube A, alteration of level in G_1 causes alcohol to enter slowly from the inverted flask, and so the concentration process proceeds automatically. It is only necessary to re-fill the flask, when it become empty, first with 70 p.c., then with 90 p.c., and finally with absolute alcohol. The same apparatus, with slight modifications, may be used for hardening and washing processes.

New Methods of Investigating the Central Nervous Systems of Vertebrates.†—Under this title B. Rawitz describes new methods of fixing and staining portions of brain and spinal cord. Material, which has been preserved in 10 p.c. formalin, is transferred to a 10 p.c. solution of tincture of iodine in 95 p.c. alcohol. After 5 days the material is removed to a saturated watery solution of potassium bichromate. This solution is changed after 24 hours, and in this second bichromate bath the tissues remain for 7 to 10 days, according to the size of the pieces. They are then removed, dried with filter paper, and put into 95 p.c. alcohol for 3 days, absolute alcohol for 2 days, and chloroform for 2 days. Then after 24 hours in chloroform-paraffin, the material is imbedded in paraffin.

The author gives accounts of a number of new stains, namely indulin, indamin-blue, and azo-acid-blue. The last-named stain, made up in the following combination—azo acid-blue B (Höchst), 2 grm. ; tartar emetic, 1 grm. ; oxalic acid, 4 grm. ; distilled water, 200 c.cm.—gave good results. The ganglion-cells and neuroglia are coloured purple, the axis-cylinders light blue. With this stain made up in some other combinations, the author could not obtain this amphichromatic effect. He ends his paper with illustrations of the application of his methods.

* Zeitschr. wiss. Mikrosk., xxvi. (1909) pp. 211-19.

† *Torn. cit.*, pp. 337-52.

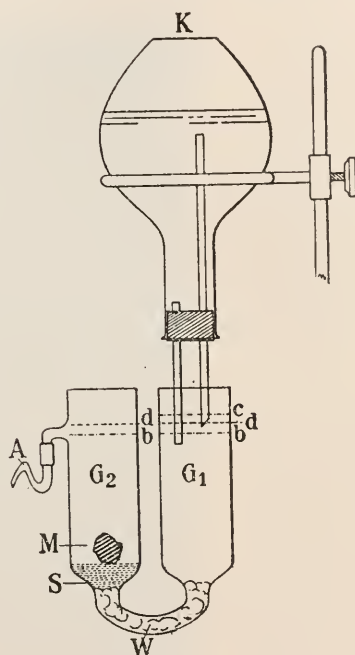

FIG. 36.

Washing Apparatus for Fixed Material.*—R. Kowler describes an apparatus (figs. 37, 38) by means of which tissues can with safety be washed in a stream of water. The apparatus is made of glass, of the form shown in the diagram. The rubber tube is connected with a water supply. The expanded chamber is at each end separated from the narrow part of the glass tube by a sieve of glass (Glassieb). The material is introduced into the chamber, which is then closed, and the water is turned on slowly at first, until the air is driven out. Then the current of water

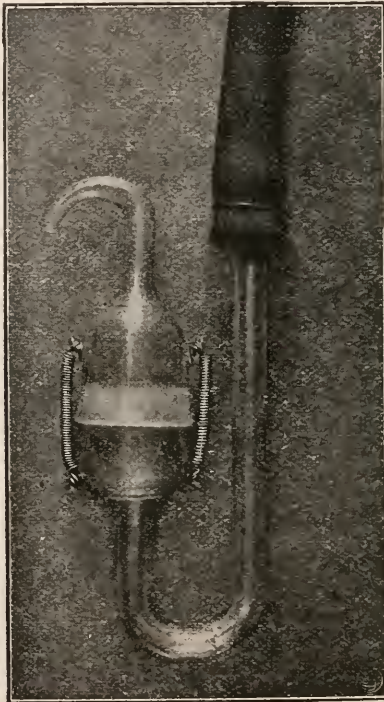

FIG. 37.

is so adjusted that the material remains on or near the bottom of the chamber.

Methylated Spirits for Histological Purposes.†—In the German Empire spirits of wine for commercial purposes consists of 90 p.c. ethyl-alcohol, to which have been added small quantities of methyl-alcohol, acetone and pyridine bases. C. Kittsteiner finds that, as a fixing reagent, this fluid is for ordinary purposes almost as good as ethyl-alcohol. Material must, however, only remain in it for three days, and must then

* Zeitschr. wiss. Mikrosk., xxvi. (1910) pp. 259-60.

† Tom. cit., pp. 191-203.

be removed to uncontaminated alcohol. Treatment of nervous tissues with methylated spirits gives extremely bad results, and with unstriated muscle also the results are most unsatisfactory. For hardening and staining purposes, this reagent is quite as good as the ordinary 90 p.c. alcohol.

Preparing Delicate Embryonic Tissues for Histological Examination.*—For cytological and histogenetic investigations of Vertebrate



FIG. 38.

embryos, A. Maximow has devised modified methods of fixation and imbedding suitable for such easily damaged material. As fixing re-agent, he uses a modified Zenker's fluid of the following composition:—Formalin 10 c.cm., sodium sulphate 10 gm., potassium bichromate 25 gm., corrosive sublimate 50 gm., distilled water 1000 c.cm. For some purposes he adds 10 c.cm. of 2 p.c. osmic acid to this solution. In the case of larger embryos the specimen must be so prepared by incision, or otherwise, that the fixing fluid can readily gain access to all parts. After careful dehydration the specimens are imbedded in celloidin and cut by

* Zeitschr. wiss. Mikrosk., xxvi. (1909) pp. 177-90.

means of a sliding microtome. The block is kept moistened with 65 p.c. alcohol. Each section, as it is cut, is transferred to a slide, cleared with oil of cloves, and washed free of celloidin with absolute alcohol and mixed alcohol and ether. Maximow uses a large number of staining methods, of which he recommends particularly the iron-alum-hæmatoxylin method, Giemsa stain and Dominici's eosin-orange-toluidin-blue process.

Examining the Structure of Human Heart-muscle.*—Irene von Palschewska fixed the material mostly in a mixture of absolute alcohol 90, and pure 25 p.c. nitric acid 10. The pieces used, about 8 mm. thick, were left in the fluid for about 24 hours, and when removed were transferred to faintly alkaline 94 p.c. alcohol, and this was renewed daily. After a few days, ammonia-free alcohol was used. The alcohol was afterwards downgraded to water for staining purposes, and the staining was effected with hæmalum.

Marie Werner † fixed her material in the 10 p.c. nitric acid and absolute alcohol 90 p.c. mixture, and then washed out with 94 p.c. alcohol, until litmus paper was no longer reddened. She found that neutralisation with ammoniated alcohol impaired the picture. The preparations were stained with hæmalum (1 part to 5–10 water). The pieces remained in the stain for 8 days.

New Methods for Examining Sputum.‡—P. Uhlenhuth recommends his antiformin method for demonstrating the presence of tubercle bacilli. By means of a 20–25 p.c. solution, the sputum is rendered quite homogeneous. It is then centrifuged, and the deposit washed with saline. As the antiformin kills off the associated bacteria, it may be used for obtaining pure cultures of human tubercle bacilli.

H. Haserodt is of opinion that the foregoing antiformin method has a great disadvantage: the film does not fix well to the slide; and recommends the following modification. The sputum should first be rendered homogeneous by means of caustic potash, and then shaken up with ligroin. A combination of the antiformin and ligroin methods gives good results.

G. Bernhardt proceeds as follows: About 5 c.cm. of sputum and 20 c.cm. of a 20 p.c. solution of commercial antiformin are placed in a stoppered bottle. When quite homogeneous, ligroin, to form a layer 3–5 mm. thick, is poured in. The bottle is then vigorously shaken, until a thick suspension forms; it is then left at room temperature for about half an hour, and afterwards loopfuls of the layer immediately underneath the ligroin are removed. Films are fixed and stored in the usual way.

H. Hammerl uses a solution composed of 99 parts ammonia and 1 part caustic potash. A mixture of 5 parts of the solution to 1 of sputum is then vigorously shaken. In a few minutes it is quite homogeneous. To 15 c.cm. of the mixture are added 5 c.cm. acetone. This

* Arch. Mikr. Anat. u. Entwickl., lxxv. (1910) pp. 41–100 (18 figs.).

† Tom. cit., pp. 101–48 (53 figs.).

‡ Centralbl. Bakt., 1te Abt. Ref., xlv. (1909) pp. 282–4.

is centrifuged for half an hour. Films are made from the deposit, and stained in the usual way.

GLAESER, K.—*Untersuchungen über die Herkunft des Knorpels an regenerierenden Amphibienextremitäten.*

Arch. f. Mikr. Anat. u. Entwickl., lxxv. (1910) pp. 1–39 (1 pl. and 16 figs.).

(3) Cutting, including Imbedding and Microtomes.

Cutting Thin Parallel Slices of Brain Substance.*—K. Berliner describes an apparatus (fig. 39) which has been in use at the hospital in Giessen for a number of years. The material to be cut is fixed on a sliding base (Sch) which moves along grooves in the bars L, L, one of which is provided with a scale. The vertical rods, F, F, guide the

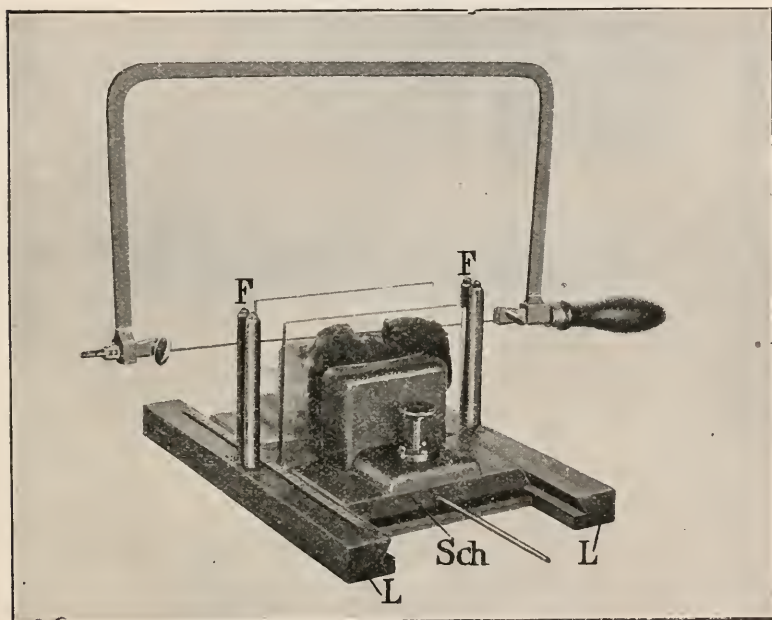

FIG. 39.

movements of the knife or fretsaw, and so vertical slides of equal thickness can be made. For fresh material a knife is used, but in the case of brains hardened in Müller's fluid or in bichromate it is found that a fine fretsaw is more suitable.

Apparatus for Whetting a Microtome Knife.—J. Lendvai has found Apáthy's method of whetting the best. This consists in the application of emery, Vienna chalk, iron-oxide, or diamantin powder, on three mirror-glass plates. For this purpose the author has devised a special apparatus, which has been constructed for him by the firm of C. Reichert. The three plates are necessary because the materials are of

* *Zeitschr. wiss. Mikrosk.*, xxvi. (1909) pp. 382–4.

† *Tom. cit.*, pp. 203–5 (5 figs.).

different degrees of hardness. One plate is for emery, the second for Vienna chalk, and the third for iron oxide or diamentin. These three

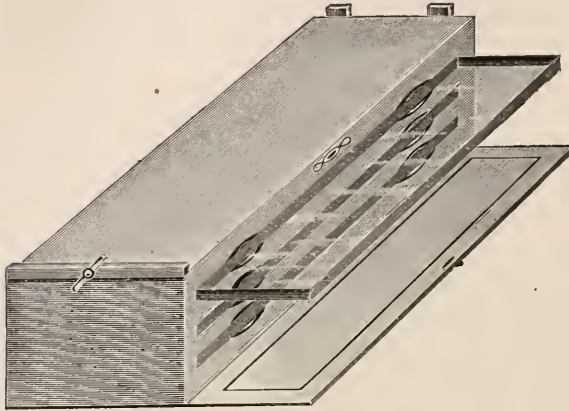

FIG. 40.



FIG. 41.



FIG. 42.

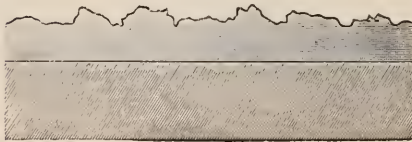

FIG. 43.

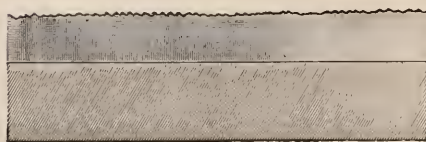

FIG. 44.

glass plates are kept in a wooden block, each in a separate compartment, the compartments being lined with cloth (fig. 40); the intention being to prevent soiling the plates with dust or with foreign material, which

might possibly notch the knife. When in use, the glass plate is laid on the upper face of the block and is fastened down with screws. It is then smeared with a fine emery paper moistened with distilled water; or with Vienna chalk paper moistened with distilled water; or with iron oxide. The knife is then drawn rather frequently over the plate (60 or 70 times), and the edge is held forward, in such a position that it is perpendicular to the direction of movement. The knife-edge as it appears under a magnification of 100 diameters is shown in fig. 43. A special facet of 20° to 25° is ground on the knife by placing the back of the knife in a laterally-open iron tube, and clamping it with screws (fig. 41). From the diameter d of the tube and the breadth a of the knife the angle ($\alpha_1 + \alpha_2$) can be calculated. Thus

$$\frac{d}{2a} = \tan \alpha_1 \pm \tan \alpha_2$$

(fig. 41). The facet, which has been roughly fashioned with emery, is perfected with Vienna chalk, the teeth on the edge now becoming very fine (fig. 44) under the same magnification as before. The iron-oxide is only used for whetting that side of the facet which glides, when in action, on the paraffin or celloidin.

Rotatory Method in Microscopy.*—H. Lebrun, after three years' experience of his method of diskal arrangement,† sees his way to several improvements, the first of which is concerned with the microtome. It was found that in cutting very thin sections tremor of the machine caused much irregularity in the sections themselves. This difficulty the author remedies by attaching the knife-carrier to parts of the microtome not liable to agitation. The paraffin block, instead of being truly rectangular, is now made with sloping slides according to the size of the disk on which the serial sections are to be received. Full directions are given for accurately obtaining the proper shape of block. There are several other improvements in the mechanism and manipulation of the microtome. As above-mentioned, the object-carrier is disc-shaped, the rectangular form being abandoned. An ingenious combination of hand and screw-work brings every part of the object, in spiral fashion, successively under the objective. This arrangement is also particularly convenient in the case of such an object as a tapeworm. The author recommends his method as tending to great economy both in materials and in time. His ideas have been satisfactorily worked out for him by the firm of Seibert, of Wetzlar.

Simple Method of Paraffin Imbedding in Vacuo.‡—W. Berg describes a method which is applicable to any ordinary paraffin oven. The paraffin is contained in a glass flask, firmly stoppered, which communicates by means of stout rubber tubing with an ordinary water suction apparatus. The rubber tube passes through the hole in the top of the oven, which normally holds a thermometer. It is advisable that the paraffin should fill only the lowest portion of the flask, as it foams somewhat, when the exhausting process is commenced. This procedure does not interfere with the ordinary use of the oven.

* Zeitschr. wiss. Mikrosk., xxvi. (1909) pp. 223-41 (13 figs.).

† See this Journal, 1906, p. 725.

‡ Zeitschr. wiss. Mikrosk., xxvi. (1909) pp. 209-10.

(4) Staining and Injecting.

Method of Staining Peripheral Nerves.*—T. Maruyama discusses the method devised by Yamagiwa and its applicability to pathological tissues, more particularly in connection with the study of beri-beri. The process is as follows:—After hardening in Müller's fluid in the ordinary way and imbedding in celloidin, sections are cut. They are stained in concentrated alcoholic eosin for a period of from 1 to 12 hours. Next, after prolonged staining with concentrated watery anilin-blue, they are placed in a differentiating fluid—weak alcohol made slightly alkaline by the addition of liquor potassæ—and washed in distilled water. The sections are then put into weak alcohol to remove excess of anilin-blue, dehydrated in absolute alcohol, cleared in oil, and mounted in balsam. In sections stained thus, the axis-cylinders appear deep blue, medullary sheaths red, connective-tissues and cell-nuclei bright blue, red blood-cells pink, and unstriated muscle pale violet. The preparations lose their stain usually in a few months.

Fluoride of Silver in Golgi's Method.†—E. Saragnone describes a new procedure for demonstrating the intracellular network. It is really a modification of Golgi's method, fluoride of silver being substituted for the nitrate. The preparation used is known as "tachiolo Paternó," and is a 10 p.c. solution of silver fluoride, which is not reduced by the action of light. The full procedure is as follows: 1. The pieces are fixed in a solution consisting of formalin (20 p.c.) 30 gm.; saturated solution of arsenious acid, 30 gm.; alcohol (96 p.c.) 30 gm. Time, 10 to 12 hours. 2. The pieces are then transferred to tachiolo Paternó, 30 c.cm.; distilled water, 100 c.cm., for one or two hours. 3. They are next washed quickly in distilled water, after which they are immersed for a few minutes to an hour in hydroquinone, 30 gm.; sulphite of soda, 5 gm.; formalin, 50 gm.; water, 1000 c.cm. 4. After washing in distilled water the pieces are passed through up-graded alcohols to xylol and imbedding. 5. The sections are treated with the following solutions mixed immediately before use: (a) hypo-sulphite, 30 gm.; sulphocyanide of ammonium, 30 gm.; water, 1000 gm.; (b) chloride of gold, 1 gm.; water, 100 gm. The reaction is watched and suspended when the sections have assumed a definite grey tint. 6. Wash in distilled water and pass rapidly through permanganate of potassium, 0.5 gm.; sulphuric acid, 1 gm.; distilled water, 1000 gm. 7. Wash rapidly in 1 p.c. solution of oxalic acid, and afterwards in distilled water. 8. Stain with carmalum. Wash again. 9. Pass through alcohol and mount in balsam.

Studying the Development of Crucifera.‡—R. Vandendries fixed the material for a day or so in Bouin's fluid, then washed it till it was white in one-third alcohol, and afterwards preserved it in 80 p.c. alcohol. Sections, 8–12 μ , were stained preferably by Heidenhain's method. As the slow method was found not to be particularly suitable for

* Mitt. Med. Fakul. K.-Jap. Univ., viii. 3 (1909) pp. 368–70.

† Pathologica, i. (1909) pp. 536–8.

‡ Zeitschr. wiss. Mikrosk., xxvi. (1909) pp. 422–4.

studying the phenomena of fertilisation, a more rapid procedure was adopted. In this the alum mordant was used for 15 to 30 minutes; this was followed by hæmatoxylin staining for 1 to 3 hours. Differentiation was effected with great care and constant inspection under the Microscope. Congo-red was used in contrast stain and gave excellent results.

Device for Protecting Mounted Sections during Dehydration.*—

It is a common experience that when a number of slides bearing sections are put in a flask of alcohol, or other fluid, specimens may be spoiled by movements of the slides against each other. C. Funck suggests a simple plan for remedying this (fig. 45). A grid, preferably of nickel-plated brass, of the form shown in the figure, is placed inside the flask, resting on the bottom. The lower ends of the slides rest in the

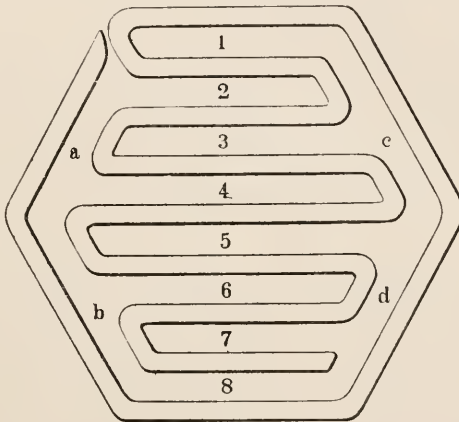

FIG. 45.

numbered spaces. The slides thus remain, touching only at the top edges. The portion of the slide which bears the section is kept free from all contact with its neighbours.

Injection Methods applied to certain Mollusca. †— B. Možejko describes a method of gelatin injection for the anatomical investigation of *Anodon*, *Mytilus edulis*, and some other Mollusca. For the greater part of his work, the author used a 4–6 p.c. solution of gelatin. By the use of finely powdered insoluble mineral dyes, he was able to tint the gelatin variously, and thus differentiate the separate systems or vessels injected. For example, in the case of *Anodon*, it is possible to inject the arteries, veins, intestine, genital ducts, and the cavities of the organs of Bojanus separately, and thus get a specimen injected in five colours. Specimens so injected can be fixed in formalin, and imbedded in paraffin for the purpose of cutting sections.

* La Cellule, xxv. (1909) pp. 415–60 (1 pl. and 54 figs).

† Zeitschr. wiss. Mikrosk., xxvi. (1909) pp. 353–77.

Different Methods of Staining Tubercle Bacilli.*—Karl Bergen gives a critical review of the literature of this subject, describing the staining methods employed by various authorities, and dwelling particularly upon the granules (sc. spores) which are brought out by some methods. For his own research, he selected Much's modification of Gram, Ziehl-Neelsen, and Gasis' methods as the three most promising. Gasis' plan is a reversal of the Ziehl-Neelsen procedure. After staining in an acid stain, the film is decolorised by alkali. Gasis maintained that the alkali-fast property of tubercle bacilli is possessed by organisms in very young and very old cultures, organisms not often acid-fast, as well as by bacilli of the average period.

Bergen found that the advantage of the Ziehl-Neelsen method lay in its ease and certainty. On the other hand, the granular form of the tubercle bacillus was hardly stained at all, and some young forms did not retain the stain. Modified Gram staining is not suitable for differential diagnosis, and in preparations from pure cultures a clear picture is not obtained. The method of Gasis is peculiarly suitable for investigation of minute structure. It gives beautiful films. On the other hand, the technique is difficult, and the results therefore may be inconclusive in cases of differential diagnosis. This method is perhaps the most suitable for making permanent preparations.

Further, Bergen gives an interesting account of the effects obtained by him as a result of combinations of these methods.

Studying the Development of Dentine in Mammalia.†—For the histological investigations in this research, G. Heinrich used a variety of reagents such as formalin, alcohol, Zenker's fluid, osmic acid, and others for fixing his material. Formalin gave the best results, especially when used in connection with the silver-staining process.

By staining sections successively with iron-alum-hæmatoxylin, dilute rubin S and Heidenhain's connective-tissue stain, good contrasts were obtained. Connective-tissue fibres and the uncalcified ground substance were stained deep red, calcified areas black, and tooth-fibres pale grey. The odontoblasts are stained more deeply than the connective-tissue cells.

In the silver process, the paraffin sections, after prolonged soaking in 2 p.c. silver nitrate, are treated with an ammoniacal silver solution. The stain is developed in a formalin bath, and treatment with gold chloride, followed by hyposulphite, completes the silver staining. The sections are then mounted on slides and washed with xylol to remove paraffin, and then with alcohol. Alcoholic solution of light-green is used as counterstain, and the section is then dehydrated and mounted in Canada balsam. These preparations are well adapted for microphotographic purposes.

(6) Miscellaneous.

Experimental Study of Development during the past decade.‡
The advances in this branch of investigation are surveyed by O. Levy.

* Centralbl. Bakt., 1te Abt., liii. (1910) pp. 174-208.

† Arch. Mikr. Anat., lxxiv. (1909) pp. 783-8.

‡ Zeitschr. wiss. Mikrosk., xxvi. (1909) pp. 426-73.

He deals first with artificial parthenogenesis. J. Loeb's experiments upon the ova of Echinoderms showed that it was possible by the use of saline solutions of various strengths to initiate developmental changes. The most successful and suggestive chemical excitant was a dilute cyanide solution, in which 90 p.c. of unfertilised ova developed into larvæ.

Roux, Herbst, and others have directed their attention to the medium in which development takes place, and to the importance of its constituents. By altering the quantities of oxygen, water, and salts in this medium, development was variously influenced.

Injury to the ovum in its earliest stages, deprivation of chromatin, shaking apart of blastomeres, amputation of blastomeres, artificial fusion of ova, and the effects of such mechanical interferences, form the subject of the next series of researches here reviewed. Others have studied the abnormalities of development caused by interference at a later stage with the primitive layers and organ-rudiments by mechanical and other means.

In the remainder of the paper the recent work upon regeneration, transplantation, and functional correlation are reviewed. Full references are given throughout, rendering the article a valuable guide to the subject.

Simple Method of Counting Leucocytes.*—This method, devised by V. T. Carruthers, depends upon the fact that when equal-sized drops of diluted blood are placed on a clean slide, they should cover equal areas and contain equal numbers of cells. Drops of blood, well diluted, are placed on a grease-free slide by means of a grease-free glass rod, and allowed to dry. The blood-pigment is washed off with water and the slide is stained with watery methylene-blue. A number of fields in each film are counted. By means of an obturator inserted in the eye-piece of the Microscope, the author has simplified the enumeration process. By comparing a few counts with the numbers obtained with a Thoma-Zeiss hæmatocytometer, a standard is obtained, so that from the average number of leucocytes in a field, the degree of leucocytosis can be calculated. For all counts, the degree of dilution must, of course, be the same, and the same glass rod and obturator must be used. The successful application of this method depends upon careful observation of a number of trivial details, for an account of which the original paper should be consulted.

Method of Estimating the Hardness of Minerals.†—B. Halle claims that this method of estimating hardness by grinding, devised by him, is superior to the scratching methods. By the latter method it is difficult to get constant results owing to variations in the quality of the diamond point used, and to the difficulty of maintaining even pressure during the scratching process. In Halle's method the mineral is ground on a revolving brass plate for a definite time, and the loss of weight is observed. The specific weight of the mineral is known. All the other factors—time, pace and pressure of grinding, grinding material—are constant, and therefore the only variable, proportional loss of weight, gives the relative hardness. By this method very fine differences in degree of hardness can be estimated.

* Brit. Med. Journ., (1909) ii. p. 1749.

† Zeitschr. wiss. Mikrosk., xxvi. (1909) pp. 424-5.

Metallography, etc.

Microstructure of Copper.*—W. Stahl gives photomicrographs of samples of copper taken from the molten bath at different stages in the final refining operation. At the beginning the copper contained 0.8–0.9 p.c. oxygen; the photomicrograph shows crystallites of cuprous oxide in a ground mass of eutectic. There is a continuous diminution in amount of oxide present till in the refined copper a thin network of eutectic surrounds the grains of copper.

Physical Properties of Alloys.†—E. Pannain finds that the specific gravity of coinage alloys (bronze and silver-copper alloy) is raised considerably by the mechanical treatment involved in the manufacture of the coins. Most of the increase in density occurs in the first rolling.

Some Zinc Alloys.‡—B. E. Curry has determined the equilibrium diagram of the antimony-zinc system by taking heating curves of 27 previously annealed alloys. The diagram thus obtained differs in important respects from that given by Mönkemeyer, and to a smaller extent from that given by Zemczuzny. Six solid phases occur in the diagram: pure antimony, pure zinc, the compound ZnSb, and three series of solid solutions, α , β , and γ . The α and β phases are instable below 437° and 405° C. respectively. The γ phase is stable only below the solidus. The results demonstrate the inadequacy of cooling curve determinations. The two phases in the zinc-tin diagram are pure zinc and a solution of zinc in tin, having a maximum concentration of about 7 p.c. at 180° C. In the zinc-cadmium diagram the two phases are two solid solutions, zinc in cadmium (maximum concentration 4 p.c. at 217° C.), cadmium in zinc (maximum concentration 5 p.c. at 217° C.). The liquid melt separates into two layers in the zinc-lead and zinc-bismuth systems. Particulars of suitable etching reagents are given.

Alloys of Silver with Zinc.§—N. A. Pushin and M. S. Maximenko have determined the specific resistances, the temperature-coefficients of the specific resistances, and the thermo-electric forces of alloys of silver and zinc. The existence of the following compounds is inferred: Zn₆Ag, Zn₄Ag, Zn₃Ag₂, ZnAg, ZnAg₂ (?), Zn₂Ag (?) and Zn₁₀Ag (?). Several series of solid solutions are formed.

Alloys of Tin and Lead.||—The linear relation between composition and electrical conductivity of tin-lead alloys appears to indicate that neither compounds nor mixed crystals are formed. On the other hand, the thermal evidence points to the existence of mixed crystals at both

* Metallurgie, vi. (1909) pp. 609–10 (8 figs.).

† Atti R. Accad. Lincei, xviii. (1909) pp. 700–1, through Journ. Soc. Chem. Ind., xxviii. (1909) p. 1089.

‡ Journ. Phys. Chem., xiii. (1909) pp. 589–605 (7 figs.).

§ Journ. Russ. Phys. Chem. Soc., xli. (1909) pp. 500–24, through Journ. Chem. Soc., xcvi. (1909) pp. 539–40.

|| Zeitschr. Elektrochem., xv. (1909) pp. 125–9, through Journ. Chem. Soc., xcvi. (1909) p. 319.

ends of the diagram. W. Guertler suggests as an explanation of this discrepancy that the mixed crystals formed during solidification decompose at lower temperatures into tin and lead.

Alloys of Lead with Indium and Thallium.*—N. S. Kurnakow and S. Zemczuzny have determined the electrical conductivity curve of the lead-indium and lead-thallium systems. The plasticity of the alloys was also studied by determining the pressure required to produce flow through an aperture of given size. The flow-pressure curve was found to follow closely the Brinell hardness curve, and was the reverse of the conductivity curve. The authors conclude that lead and indium form a continuous series of mixed crystals. Lead and thallium form three series of mixed crystals. No compounds occur in either system.

Aurides of Magnesium.†—G. G. Urasow has made a careful determination of the equilibrium diagram of the gold-magnesium system. The cooling curves of 109 alloys were taken. In some regions of the diagram inoculation was necessary to prevent supercooling. The compounds occurring and their melting points (dystectic points or maxima in the diagram) are Mg_3Au $818^\circ C.$, Mg_2Au $788^\circ C.$, $MgAu$ $1150^\circ C.$; the compound Mg_5Au_2 is formed at $796^\circ C.$ by a reaction taking place between Mg_3Au and the liquid. Mg_5Au_2 exists in two forms, the transformation temperature being $721^\circ C.$ The microstructure of alloys rich in magnesium was sufficiently developed by polishing on wet chamois leather. Sections of the other alloys were etched with hydrochloric acid and bromine.

Phosphorus Compounds of Cobalt.‡—S. Zemczuzny and J. Schepelew have studied the range 0–33.7 atomic p.c. phosphorus of the cobalt-phosphorus system by thermal and microscopical methods. A dystectic point at 33.33 atomic p.c. phosphorus indicates the compound Co_2P , melting at $1386^\circ C.$; this compound has a transformation point at $920^\circ C.$ The eutectic contains 19.85 atomic p.c. phosphorus and melts at $1022^\circ C.$ The hardness of the alloy was measured. Co_2P was observed as well-defined crystals in sections polished and etched with ferric chloride solution in hydrochloric acid.

Systems: Tin-sulphur, Tin-selenium, Tin-tellurium.§—W. Biltz and W. Mecklenburg have determined the equilibrium diagrams. The volatility of sulphur restricted the range of the tin-sulphur system investigated to 0–23.4 p.c. sulphur. The compounds occurring and their melting points are SnS , $882^\circ C.$; $SnSe$, $861^\circ C.$; Sn_2Se_3 or $SnSe_2$, about $650^\circ C.$; $SnTe$, $800^\circ C.$ The compounds SnS , $SnSe$, and $SnTe$ were observed microscopically in sections of the alloys.

The System $Cu_2S-FeS.$ ||—K. Bornemann and F. Schreyer have determined the equilibrium diagram by thermal methods and confirmed it by microscopical examination of the melts after solidification. The

* Zeitschr. Anorg. Chem., lxiv. (1909) pp. 149–83 (5 figs.).

† Tom. cit., pp. 375–96 (16 figs.).

‡ Tom. cit., pp. 245–57 (7 figs.).

§ Tom. cit., pp. 226–35 (7 figs.).

|| Metallurgie, vi. (1909) pp. 619–30 (22 figs.).

diagram is too complex for brief summarising, and in some regions is insufficiently established. The compounds $(\text{Cu}_2\text{S})_2(\text{FeS})$, $(\text{Cu}_2\text{S})_3(\text{FeS})_2$ and probably $(\text{Cu}_2\text{S})_2(\text{FeS})_3$, or $(\text{Cu}_2\text{S})(\text{FeS})_3$, are indicated by the diagram. Concentrated nitric acid was used for etching those sections which required etching.

Mixed Crystals of Sulphur and Tellurium.*—G. Pellini finds that sulphur and tellurium do not form a compound, but form a series of mixed crystals. A solid amorphous solution of tellurium and sulphur was also obtained.

Influence of Arsenic and Tin upon Iron.†—C. F. Burgess and J. Aston have studied the magnetic properties of alloys prepared from electrolytic iron, one series containing 0.29–4.14 p.c. arsenic, the other series containing 0.29–2.06 p.c. tin. Compared with approximately pure iron, the alloys give materially lower hysteresis losses and have a higher permeability.

Phosphides of Iron.‡—H. le Chatelier and S. Wologdine point out that many metallic compounds, which have been described from time to time, are imaginary. Until these supposed compounds are eliminated, by the application of modern metallographic methods of investigation, it is not possible to arrive at any laws governing the formulæ of metallic compounds. An examination of the compounds of iron and phosphorus reduces their number from nine to four. The existence of Fe_3P and Fe_2P is undoubted, that of FeP and Fe_3P_3 is very probable, but their formulæ are not so well established as those of Fe_3P and Fe_2P .

Alloys of Iron.§—P. Oberhoffer briefly summarises published work on the binary and ternary alloys of iron. Our knowledge of the equilibrium diagrams is incomplete for the binary systems, and is still less advanced for the ternary systems.

Heat-treatment of Iron and Steel.||—Methods of heat-treatment suitable for various descriptions of carbon steel are specified. The position of A_c3 , in steels containing not more than 0.90 p.c. carbon, may be calculated approximately from the formula

$$A_c3 = (900 - 200c)^\circ\text{C},$$

c being the percentage of carbon in the steel.

W. Campbell† has made further experiments on the removal of "ingotism" by annealing. In a previous investigation he had found that in a steel casting containing 0.43 p.c. carbon, the coarse ferrite network was not completely removed at 1180°C ., but could not be detected after heating to 1195°C . The present work was done on two pieces of steel castings (a) and (b) containing 0.35 and 0.5 p.c. carbon

* Atti R. Accad. Lincei, xviii. (1909) pp. 19–24, through Journ. Chem. Soc., xcvi. (1909) p. 805.

† Electrochem. and Met. Ind., vii. (1909) pp. 403–5 (3 figs.).

‡ Comptes Rendus, cxlix. (1909) pp. 709–14.

§ Metallurgie, vi. (1909) pp. 612–18.

|| Amer. Soc. for Testing Materials, Proc. ix. (1909) pp. 214–18. (Report of Committee on heat-treatment of steel) † Tom. cit., pp. 370–7 (12 figs.).

respectively. The manganese sulphide and slag occurred as strings or veins in (*b*), but were evenly distributed as small globules in (*a*). Heating a little above $Ac\ 2-3$ completely refined the structure of (*a*), but did not altogether remove the ferrite network of (*b*). A network of manganese sulphide or slag appears to prevent complete refining by acting as nuclei on which the ferrite precipitates.

Defects in Steel Rails.—H. Fay and R. W. G. Wint* describe the various ways in which the presence of slag (manganese sulphide, manganese silicate, and possibly other substances) may cause the failure of rails. In many sections examined the sulphide was seen to be broken at right angles to its length, its extreme brittleness causing it to break during preparation for microscopic examination. Cracks invariably begin in and follow from one slag area to another. Flow of metal in many cases appears to be due to the presence of internal cracks originating in slag inclusions. Hard spots in rails are due to (1) imperfect solution of ferro-manganese; (2) surface hardening through friction of the wheels; (3) segregation. The authors believe that some hard areas containing martensite and troostite, found in a nickel steel rail, were caused by segregation of nickel.

R. Job† has investigated some defective open-hearth steel rails, and has found that failure was the result of segregation, piping, and unsoundness.

P. H. Dudley‡ has found that in numerous cases of splitting of heads of rails, etched sections of the rail show dark streaks, found to be harder and to have a higher carbon content than the rest of the rail. The presence of these dark streaks is ascribed to the inclusion in the steel of metal washed away from the cast-iron base of the ingot mould, by the impinging of the stream of molten metal when the ingot was cast.

Tests of Ingots.§—J. E. Howard has examined with the unaided eye and microscopically, sections of ingots, and of the various forms derived from them during their manufacture into rails. In this way the effect of reduction by rolling upon size and shape of grain, gas or shrinkage cavities, and slag inclusions, was followed step by step.

Closing of Blowholes in Steel Ingots.||—H. M. Howe found that, while comparatively great variations in density occurred in a steel ingot due to the presence of blowholes, the plates rolled from the same ingot were of uniformly high density. Contrary to the generally accepted view, it would appear that the gas is driven out of the blowholes during rolling. It should, therefore, be possible to close and weld up blowholes by rolling.

Structure of Cast Iron.¶—F. J. Cook and G. Hailstone explain variations occurring in the mechanical properties of a series of cast irons of identical chemical composition, by differences which they found in

* Amer. Soc. for Testing Materials, Proc. ix. (1909) pp. 77-89 (14 figs.).

† Tom. cit., pp. 90-97 (12 figs.).

‡ Tom. cit., pp. 98-105 (9 figs.).

§ Tom. cit., pp. 319-26 (10 figs.).

|| Tom. cit., pp. 327-47 (7 figs.).

¶ Foundry, xxxv. (1909) pp. 21-3 (13 figs.).

microstructure. High tensile strength appeared to be associated with a comparatively fine state of division of the graphite, and a net-like formation of the phosphorus eutectic.

Magnetic Properties of Alloys of Ferro-magnetic Metals.*—G. Tammann deduces some general rules from the experimental data previously published by himself and others, relating to the magnetic properties of alloys containing iron, cobalt, and nickel. A solid solution of a non-magnetic in a ferro-magnetic metal is magnetic, while a solid solution of a ferro-magnetic in a non-magnetic metal is non-magnetic. Chemical compounds are practically non-magnetic. The depression of the temperature at which magnetic properties disappear on heating, by the presence of other elements, is discussed.

Magnetic Character of Compounds of Non-magnetic Elements.† E. Wedekind has studied the magnetic properties of the compounds MnB, MnSb, Mn₂Sb, and MnP. The greatest temporary magnetism was shown by MnSb, the least by MnP.

Metallographic Observations at High Temperatures.‡—P. Oberhoffer has attacked the problem of direct microscopic examination of easily oxidised metals at temperatures up to 1000° C. The le Chatelier stand with horizontal stage above the Microscope tube is used. The section is held, polished face down, at the lower end of a vertical quartz tube on which a heating coil of platinum wire is wound. The quartz tube is contained within a glass vessel with flat bottom, through which the specimen is observed, surrounded by a brass cooling vessel, through which water circulates. A vacuum is maintained in the glass vessel by means of an air-pump. Gases can be introduced for etching the hot specimen; chlorine and hydrogen were tried. A diaphragm of sheet platinum resting on the flat bottom of the glass vessel, reflects upwards heat which would otherwise be radiated downwards to the Microscope objective, but permits observation through a central opening. A thermocouple in contact with the specimen enables its temperature to be followed. During the heating the specimen was observed, usually with a 16 mm. objective and Zeiss No. 18 compensating eye-piece, till the beginning of a change was noted. The heating current was cut off, and the specimen, when cool, was photographed without being disturbed. Heating was then resumed, and when the change had proceeded further, the specimen was cooled and photographed again. These operations were repeated as required. In this way the transformation from austenite to pearlite was followed, but more definite results were secured in the observation of the formation of temper carbon in cast iron. The results obtained are of value chiefly as indicating the possibilities of the method.

Determination of Melting-points.§—W. P. White discusses methods of determining melting and freezing points, and the sources of error in the results obtained. The prime cause of obliquity in melting curves is the presence of impurities, which cause the melting to occupy a certain temperature interval.

* Zeitschr. Phys. Chem., l xv, (1908) pp. 73-83.

† Op. cit., l xvi, (1909) pp. 614-32 (4 figs.).

‡ Metallurgie, vi, (1909) pp. 554-67 (41 figs.).

§ Amer. Journ. Sci., xxviii, (1909) pp. 453-73, 474-89, through Journ. Chem. Soc., xcvi, (1909) pp. 970-1.

Nitrogen Thermometer.*—A. L. Day and R. B. Sosman have completed the work of extending the gas scale of absolute temperature to 1550° C. The errors in temperature measurement with the nitrogen thermometer have been reduced to about one-fourth of their former magnitude. Much information is given as to the use of melting and freezing points of metals as fixed points. 1755° C. is arrived at by an indirect method as the melting-point of platinum. A table of melting-points of metals, etc., is given.

- BAUER, O.—**Appearance of Fractures and Quality of Materials.**
Stahl und Eisen, xxix. (1909) pp. 1338-40 (3 figs.).
- BELLOC, G.—**Emission of Gas by Heated Metals.**
Comptes Rendus, cxlix. (1909) pp. 672-3.
- BENEDICKS, C.—**A New Form of Pearlite.**
Metallurgie, vi. (1909) pp. 567-8 (4 figs.).
See also this Journal 1909, p. 407.
- COSTE, M.—**Transformations of Selenium.**
Comptes Rendus, cxlix. (1909) pp. 674-6.
- FROITZHEIM, C.—**Influence of Light on the Texture of Iron and Steel.**
Stahl und Eisen, xxix. (1909) p. 2022.
- GULLIVER, G. H.—**A New Experimental Method of Investigating certain Systems of Stress.**
Proc. Roy. Soc. Edin., xxx. (1909) pp. 38-45 (1 fig.).
- JÄNECKE, E.—**Isomorphous Ternary Mixtures.**
Zeitschr. Phys. Chem., lxvii. (1909) pp. 641-88 (70 figs.).
- HEYN, E. & OTHERS.—**Copper-ammonium Chloride Etching Method of Macroscopic Testing.**
[The practical application of the method is discussed by E. Heyn, A. v. Dormus, L. Kruff and M. Widemann.]
Stahl und Eisen, xxviii. (1908) p. 1827;
xxix. (1909) pp. 356-8, 517-8, 907-8, 1823-4.
- NEUMANN, O.—**Diamonds in Iron.**
Zeitschr. Elektrochem., xv. (1909) pp. 817-20.
- PAWLOW, P.—**Dependence of Melting-point on the Surface-energy of a Solid Body.**
Zeitschr. Phys. Chem., lxv. (1908) pp. 1-35, 545-8 (11 figs.).
- PÉLABON, H.—**Mixtures of Sulphur, Selenium, and Tellurium with Metals.**
Ann. Chim. Phys., xvii. (1909) pp. 526-66.
- ROSS, A. D. & R. C. GRAY AND F. HEUSLER & F. RICHARZ.—**Magnetic Properties of Alloys of Manganese, Aluminium, and Copper.**
Zeitschr. Anorg. Chem., lxiii. (1909) pp. 349-52; lxv. (1909) pp. 110-12.
- RUER, R.—**Ternary Systems.**
Zeitschr. Phys. Chem., lxviii. (1909) pp. 1-31 (4 figs.).
- SCHENCK, R.—**Departure from Wiedemann-Franz Law in Solid Metal Solutions.**
Metallurgie, vi. (1909) pp. 550-3 (3 figs.).
- STERN, E.—**Microstructure of Portland Cement.**
Zeitschr. Anorg. Chem., lxiii. (1909) pp. 160-7 (17 figs.).
- TAMMANN, G.—**Chemical Relationship of Metals and the Constitution of Alloys.**
Stahl und Eisen, xxix. (1909) pp. 1084-5 (1 fig.).

* Amer. Journ. Sci., xxix. (1910) pp. 93-161 (6 figs.).

PROCEEDINGS OF THE SOCIETY.

MEETING

HELD ON THE 16TH OF FEBRUARY, 1910, AT 20 HANOVER SQUARE, W.
 PROFESSOR J. ARTHUR THOMSON, M.A., ETC., PRESIDENT, IN THE
 CHAIR.

The Minutes of the Meeting of January 19, 1910, were read and confirmed, and were signed by the President.

The List of Donations to the Society, exclusive of exchanges and reprints, was read, and the thanks of the Society were voted to the donors.

Eug. Warming, Dansk Plantevækst, part 2	From The Author.
24 Micro-slides from the Collection of the late Mr. Fredk. Fitch	Miss Fitch.
An Old Microscope by Trécourt and Georges Oberhaeuser ..	The Council.
An Old Microscope by Browning.. .. .	
Eight Lieberkühn Microscopes in cases	Mr. A. N. Disney.
A Withering's Botanical Microscope	
Two Grayson's Rulings. A complete inch divided into hundredths of an inch, and 25 mm. divided into 0.25 mm. ..	Mr. Conrad Beck.

Mr. C. F. Rousselet described the Old Microscopes mentioned in the foregoing list, the instruments being severally exhibited to the Meeting.

The President said that before proceeding to read his paper, he wished to be allowed to thank the Fellows of the Society for the honour which they done to him by electing him as their President; he need hardly say that he appreciated the compliment very highly indeed. It was exactly twenty-five years since he began to work for the Journal of the Society, and he felt it a great honour to be added to the distinguished list of their Presidents, and particularly that he should be the immediate successor of their last President, Sir E. Ray Lankester—than whom since Huxley no Zoologist had made a deeper mark on British biological science. It would be his aim to do all in his power to advance the interests of the Society; they must not, however, expect too much of him, since he lived at such a great distance from London, and on that account might not be able to be present as often as he wished.

The President then read his paper, entitled "Notes on *Dendrobrachia fallax*, a Rare and Divergent Antipatharian," the subject being illustrated by specimens and by a number of preparations exhibited under Microscopes in the room. The difficulty of making satisfactory use of

the dried specimens on account of their extreme brittleness was mentioned at the conclusion of the paper, and the President asked if any Fellow knew any device by which anything could be made of a desiccated specimen such as that before him.

Mr. Wesché suggested a mixture of xylol and phenol, which he said would clear most structures, thick or thin—2 parts of xylol to 1 of phenol.

The President said he had tried in various ways to cut the polyps and to mount them whole, but always with the result that the whole thing crumbled to dust.

Dr. Hebb thought something might be done by imbedding the objects in celloidin, and retaining the celloidin with the sections so as to keep them from coming to pieces. The celloidin would not at all interfere with the examination of the object, for though the usual practice was to dissolve it out, this was not at all necessary.

Mr. A. A. C. E. Merlin's paper, "On the Measurement of the First Nine Groups of Grayson's finest Twelve-band Plate," was read by Dr. Hebb.

Mr. F. H. Collins' paper, "On the Labelling of Microscope Slides," was read by Dr. Hebb. In it the author complained of the inconvenience arising through no uniform system having hitherto been adopted, the general practice being for the name of the object to be written parallel to the short ends of the slide, in which position it was impossible to read it when placed upon the stage—whereas if written parallel to the slides it could be easily read when in that position. The communication was accompanied by drawings of slides as, in the opinion of the author, they should, and should not, be labelled.

Dr. Spitta thought the reason slides were marked in the usual manner was not far to seek: it was simply because they could be read in the cabinet far easier than if they were written in the manner just suggested.

Mr. A. D. Michael said he rose to repair an omission on their part—it was obvious that the President could not propose a vote of thanks to himself for what had been an extremely interesting communication, and he was sure the Society was very much obliged to him for bringing the specimens and for describing them in such a lucid manner. He had, therefore, very great pleasure in moving that the best thanks of the Society be given to the President for the very interesting paper he had given them in opening their proceedings that evening.

The proposal having been seconded by Mr. C. F. Rousselet, was put to the Meeting and carried unanimously.

The President, in thanking the Meeting for the vote of thanks which they had so cordially passed, said he wished to offer his own thanks to Messrs. Angus and Co., for the loan of the Microscopes under which the specimens had been shown in illustration of his paper.

A letter was read from Mr. Shearsby, in which he said he had sent to the Society a small bottle of diatoms gathered from the Yass River, in Australia, and asked if anyone would tell him the names of the species included. He further offered to collect more specimens, if desired, when out on his geological excursions.

Dr. Hebb intimated that any Fellow of the Society wishing to take up the matter, or desiring to have any of the material, should communicate with Mr. Parsons.

Mr. C. F. Rousselet said that he was exhibiting in the room, under six Microscopes, four of the six known species of fresh-water Medusæ, and two of the hydroid polyps producing them, of which he gave a short account.

The President said that Mr. Rousselet had made a very interesting communication, and he was sure they must admire the manner in which he had followed up the quest of these important types, bringing together so many representatives. He would also take the opportunity of mentioning that when Mr. Rousselet and he were delegates to the International Congress held at Boston in 1907, the beautiful microscopic preparations which Mr. Rousselet there exhibited were the subject of very strong and warm commendation.

The following Instruments, Objects, etc., were exhibited:—

The Society:—An Old Microscope by Trécourt and Georges Oberhaeuser; a Microscope by Browning, and Lieberkühn Microscopes in cases, presented by the Council; a Withering's Botanical Microscope, presented by Mr. Disney.

The President:—Various specimens and the following slides: Axis of *Dendrobrachia*; typical Antipatharian, axis; ditto, polyps—in illustration of his paper.

Mr. C. F. Rousselet:—*Limnocodium Sowerbyi*, from Regent's Park; Hydroid polyp of ditto; *Limnocyda tanganyikæ*, from Lake Tanganyika; Medusa from Hunyani River, Rhodesia (undescribed); *Marisia Lyonsi*, Hydroid stage, and ditto Medusa stage, from Lake Qarun, Egypt.

New Fellows:—The following gentlemen were balloted for and duly elected Fellows of the Society:—C. E. Mannall Fretwell and Alfred Reid.

MEETING

HELD ON THE 16TH OF MARCH, 1910, AT 20 HANOVER SQUARE, W.,
 PROFESSOR J. ARTHUR THOMSON, M.A. F.R.S.E., PRESIDENT, IN
 THE CHAIR.

The Minutes of the Meeting of February 16, 1910, were read and confirmed, and were signed by the President.

The List of Donations to the Society received since the last Meeting was read as follows, and the thanks of the Society were voted to the donors :—

	From
M. Auerbach, Die Cnidosporidien. (Svo, Leipzig, 1910,) Dr. Werner Klinkhardt)	<i>The Publisher.</i>
N. Gaidukov, Dunkelfeldbeleuchtung und Ultramikro- skopie in der Biologie und in der Medizin. (Svo,) Jena, 1910, Gustav Fischer)	<i>The Publisher.</i>
Live-box with Micrometer Scale engraved on the lower glass tablet, by Andrew Pritchard	<i>Mr. John Cooper Webb.</i>

Mr. C. F. Rousselet said that the live-box presented to the Society that evening was one made by Andrew Pritchard about 1846. It had a micrometer scale engraved on the bottom glass tablet, the idea being to enable an object placed in it to be measured, or at least its size estimated when observed, though he thought this would not be very easy to accomplish in the case of an object which kept moving about. The live-box would be a valuable addition to their collection of instruments and apparatus.

The President, in introducing a paper by Miss S. L. M. Summers, M.A., B.Sc., "On Antipatharians from the Indian Ocean," said that it was a coincidence that led him again to ask the attention of the Society to the group of animals that he had discussed at the last Meeting—the Antipatharians, or "Black Corals." The paper he had to submit was by one of his assistants, and described a collection made by two of his students, Mr. R. N. Rudmose-Brown, D.Sc., and Mr. J. J. Simpson, M.A., B.Sc., in the Mergui Archipelago and off Ibo in Portuguese East Africa. It included fourteen species of which three were new, and it threw some light on a number of species which had been previously described from axes without polyps. After referring to the variety of form among Antipatharian colonies, to the characteristic spinose axis of which fourteen examples—very similar at first sight—were shown under Microscopes on the table, to the structure of the polyps, which was illustrated by coloured diagrams and by cross-sections under the Microscopes, and to the affinities of the group, which are apparently with the sea-anemones, but must remain somewhat uncertain until the embryonic development is discovered, the President read a portion of the paper, and complimented the author on her terse and precise descriptions of species.

The paper described a collection made by two of his students, mainly in the Indian Ocean, containing fourteen species, three of which were new. The Antipatharians were popularly known as Black Corals, and were colonies of grey arborescent growths, sometimes attaining a length of 6 ft. The polyps were remotely related to sea anemones, but their life-history had not been traced, no one having yet seen a young one, so that their embryonic stages were unknown. The individual polyps had each six tentacles—except in the case of the species described by him at the last Meeting of the Society—and these were not retractile. The general structure of these organisms was then further explained by reference to coloured diagrams exhibited in the room.

A portion of the paper was then read to the Meeting—in illustration of which some specimens in bottles were exhibited and a number of mounted examples were shown under Microscopes in the room. These, the President remarked, were apparently very much alike until they were carefully looked into.

Mr. D. J. Scourfield said he was sure all present would agree that their best thanks were due to Miss Summers for submitting to the Society the paper which had just been read, and also to their President, not only for reading it, but also for the very interesting preliminary remarks on Antipatharians in general. Personally he should take a much greater interest in the group than he had ever done before, and he believed many other Fellows would do the same. He would like to mention that Miss Summers' paper was not the first they had had by a lady, and he certainly hoped it would not be the last. On the contrary it was sincerely to be hoped that the Society would receive many further papers from ladies in the future.

Mr. E. M. Nelson's paper "On the Visibility of the Tertiaries of *Coccinodiscus asteromphalus* in a Balsam Mount" was read by Dr. Hebb.

Mr. E. J. Spitta, in reply to the President, said that as they had no illustrations before them giving the details of what Mr. Nelson had seen, it was difficult to say anything on the subject. It would be interesting if Mr. Nelson would photograph or draw these so that the Fellows might know about what he was talking.

Dr. Hebb mentioned that a paper "On Critical Microscopy," by Mr. E. M. Nelson, had been received. The author suggested that it might be taken as read, but on consideration was deferred till the next Meeting.

Mr. A. A. C. Merlin's paper "On the Measurement of the Flagellum of the Cholera Bacillus" was read by Dr. Hebb.

Mr. E. J. Spitta said it would always be a very difficult matter to say what was really the diameter of these flagella, because it was never a constant quantity, seeing it appeared quite different according to the kind of stain with which the specimen had been treated. Not much attention had been paid to the subject as it was not of the slightest importance either to the Microscopist or the Bacteriologist.

Dr. Hebb thought that the ordinary Bacteriologist did not trouble himself very much about the measurement of flagella, or whether they

could be seen at all in non-motile organisms. He remembered on one occasion being invited to see the flagella of tubercle bacilli, but was quite unable to do so, though others who were present recognised them easily. All these points were quite caviare to him, but then he did not profess to be a critical Microscopist.

Mr. F. Shillington Scales thought that some of these measurements were of such a nature and made such exaggerated claims to minute accuracy of measurement as rather to bring the subject of micrometry into discredit amongst practical workers in laboratories. Their old friend the tubercle bacillus had been a source of considerable controversy, and the very existence of its flagella was denied by bacteriologists, yet the subject was constantly reverted to with the same result, and here claims were made as to actual measurements of the flagella. He thought it was a pity that so much attention should be given to the subject.

Mr. Rheinberg thought the extinction method of measurement was interesting, but had Mr. Merlin been present he would have liked to ask him whether precautions were taken as to the strength of the illumination, which he thought was a factor of importance for any comparative measurements of this description. The apparent size of a flagellum was greatly determined by the strength of the illumination, as this determined the apparent size of the diffraction disks which overlapped the flagellum, and the degree of opacity of the flagellum would also affect the result.

Mr. Conrad Beck, while expressing great interest in the extinction method of measurement, did not think it could be used except by the most expert microscopist who had perfect command of the illumination, and even then did not consider the results obtained could be accepted without complete confirmation from some other method, as too little was known as to the limits of resolution under different conditions of illumination. The limits of resolution of double stars had even been called in question of late, although Mr. Nelson's work on this subject had not been confirmed by Professor Porter.

Mr. Conrady said the great objection to the extinction method of measurement was that it required a knowledge of the degree of opacity of the object. It was an easy matter to compute the width required for an absolutely opaque object to be just visible with a given numerical aperture, but a semi-transparent object would have to be broader, nearly in proportion to the light which it transmitted, in order to become visible under similar conditions. For this reason such a method seemed to him illusory.

Mr. J. E. Barnard said that, looked at from a practical point of view, microbes, even of the same species in any one culture, varied very considerably in size, and it might, therefore, be inferred that the flagella would vary also; the actual benefit of exact determinations in such cases therefore seems doubtful. As to the point raised by Mr. Conrady, by the silver deposition method of staining an absolutely opaque object, could be produced by this means, although, of course, the thickness of the silver film was unknown.

Mr. Conrady begged leave to say that the silver would have to be deposited in a very appreciable thickness in order to be quite opaque.

Moreover, silver films usually became highly reflective as their thickness increased, and there would, therefore, be false light from that source.

Dr. Hebb said that Mr. F. H. Baker, of New South Wales, had written to ask if any Fellows would like to exchange for microslides of Polyzoa, of which he had a fine collection, English slides or shells. Anyone wishing to accept the offer should apply for particulars to Mr. Parsons.

The President proposed a vote of thanks to Messrs. Baker for the loan of fourteen low-power Microscopes, under which the specimens of Antipatharians were shown that evening. Carried unanimously.

It was announced that the Society had held its last Meeting in their present room, but that the next Meeting would take place on April 20th in the North Room.

The following Instruments, Objects, etc., were exhibited:—

The Society:—Live-box with Micrometer Scale engraved on the lower glass tablet, by Andrew Pritchard.

The President, in illustration of Miss Summers' paper:—Specimens in bottles, and the following slides: *Antipathes abies*, Axis, Main stem: ditto, Axis, Tip of branch; *A. gracilis*, Axis; *A. lentipinna*, Axis; *A. salicoides*, Polyps; *A. tristis*, Axis; *Cirripathes propinqua*, Axis; *C. spiralis*, Axis; *Pteropathes simpsoni*, Axis; *Stichopathes bispinosa*, Axis; *S. diversa*, Axis; *S. echinulata*, Polyps; ditto, Polyps V. S. showing ovary; ditto, Polyps L. S.; *S. gracilis*, Axis; ditto, V. S.; series of sections showing growth of ovary.

New Fellows:—The following were elected *Ordinary* Fellows of the Society: Geoffrey Alfred Bracewell, Kate M. Hall, John Craig Hatley, William Llewellyn Jones, Ethel Sargant.

Family ANTIPATHIDÆ Verrill.

Sub-family ANTIPATHINÆ Brook.

Section 1. **Indivisæ.**Genus *Cirripathes* Blainville.*Cirripathes indica* sp. n.*C. propinqua* Brook.*C. spiralis* Linn.Genus *Stichopathes* Brook.*Stichopathes diversa* (Brook) = *Cirripathes* (?) *diversa* Brook
= (?) *S. alcocki* Cooper.*S. bispinosa* nom. n. = *Cirripathes* (?) *flagellum* Brook ; n.
= *Stichopathes flagellum* Roule.*S. echinulata* Brook.*S. gracilis* Gray.Section 2. **Ramosæ.**Genus *Antipathes* Pallas.*Antipathes salicoides* sp. n.*A. furcata* Gray.*A. tristis* Duchassaing.*A. lentipinna* Brook.*A. gracilis* Gray.*A. abies* Brook.Genus *Pteropathes* Brook.*Pteropathes simpsoni* sp. n.*Cirripathes indica* sp. n. Plate V. fig. 9.See *Cirripathes* (?) Thomson and Simpson, Ceylon Pearl Oyster Report, 1905,
Supplementary Report 30, p. 95, fig. 8.

A simple colony wound in a large circle, whose circumference is 77 cm. and diameter 18 cm. The polyps are badly preserved, but are distributed all round. In some parts they are crowded together. The axis is black, 2 mm. in diameter, with a canal of 0·5 mm.; it is covered with minute spines, distinctly papillose, all alike and equal. They are arranged in no definite order, and from twenty-four to thirty can be seen from one aspect. The specimen agrees with the specimen which Thomson and Simpson described but did not name.

Locality.—Portuguese East Africa. Previously recorded from Ceylon.

Cirripathes propinqua Brook.

See Brook, Report on the Antipatharia of the 'Challenger' Expedition, 1889. p. 82, pl. x. figs. 9-13; pl. xii. fig. 14; pl. xiv. fig. 7.

Of the several broken specimens one is 32·5 cm. in length, and is very stout and straight, difficult to bend or break. It is thickly covered with cœnenchyma, and the polyps are arranged all round the axis. They are not all of the same size, the largest being about 2 mm. in diameter. They stand out prominently, about 2 mm. high. The tentacles are long and tapering, and the mouth is prominent. The axis is thickly covered with spines and is 5 mm. in diameter; the central canal is only 1 mm. in diameter. The spines are short and thick, and are longer on one side of the stem than on the other. They stand out at right angles to the axis, but are not arranged in any definite order.

Locality.—Portuguese East Africa. Previously recorded from New Guinea.

Cirripathes spiralis Linn.

See Brook, Report on the Antipatharia of the 'Challenger' Expedition, p. 85, pl. xii. fig. 10.

Of the two specimens, one is spirally coiled, 33·3 cm. round the spiral, and 8·5 cm. high; the other is twisted irregularly, 33·4 cm. in length. On the spiral specimen there are only a few polyps left; the other has numerous polyps, but badly preserved. They are crowded together and are arranged all round the axis. They are circular, 2 mm. in diameter; the tentacles are long. The cœnenchyma is very thin. The axis, which is not very stout, is black in colour. Its diameter is 1 mm., while that of the central canal is 0·5 mm. The spines are short and conical, and are longer on the outer side of the spiral than on the inner. They are arranged in spirals and longitudinal rows, eleven of which can be seen from one aspect. The members of a row are about one length apart.

Locality.—Portuguese East Africa. Previously recorded from the Indian Ocean, Molucca, Norway, Mediterranean, Ceylon, Kurrachee, and the East Indies.

Stichopathes diversa (Brook).

See *Cirripathes* (?) *diversa* Brook, Report on the Antipatharia of the 'Challenger' Expedition, p. 87, pl. 12, fig. 12.

A stout spiral, 15 cm. high. The polyps are arranged on the outer side, while the inner is left bare. They are straw-coloured in spirit, and are very flat, with long tentacles and prominent mouth. There are two types of spines, large ones with small ones between

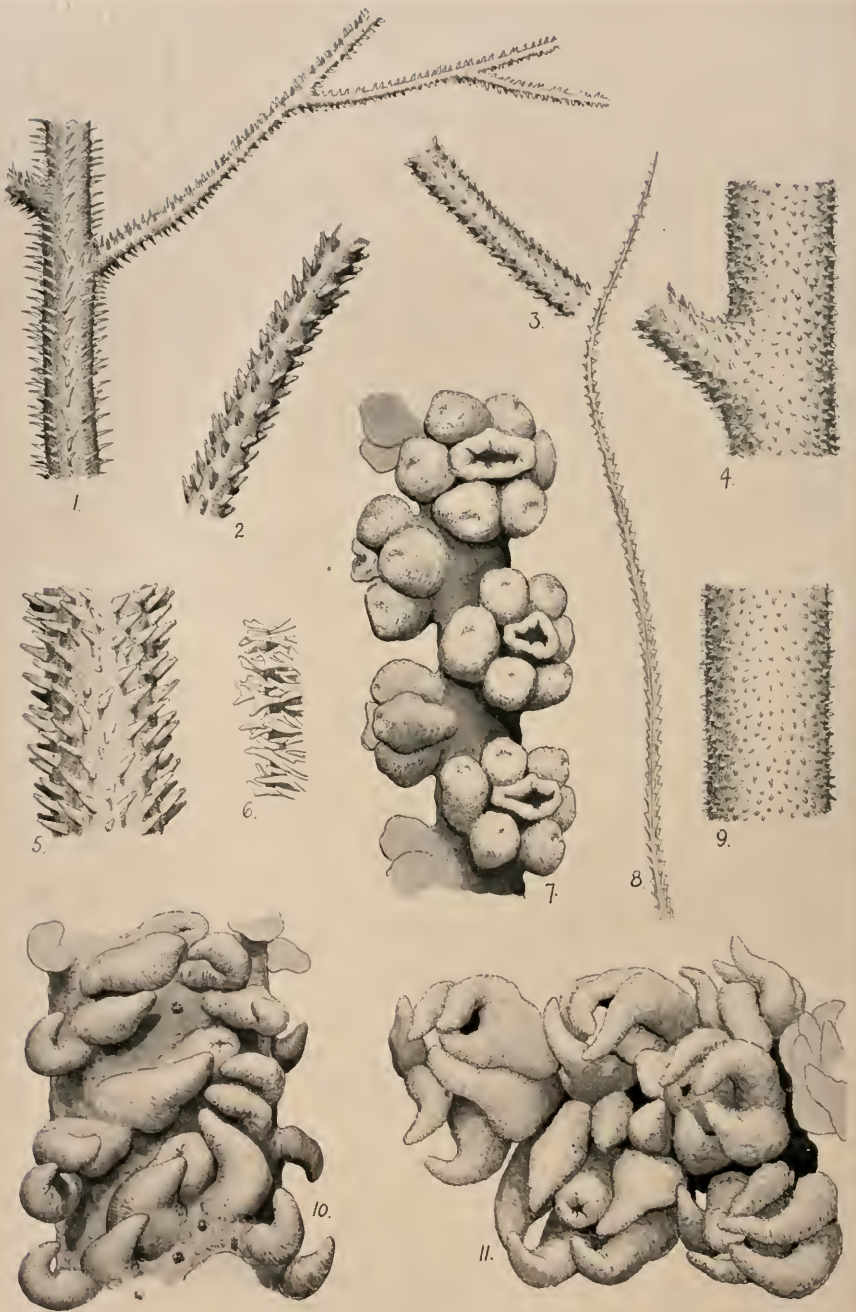

JOURNAL

OF THE

ROYAL MICROSCOPICAL SOCIETY

JUNE, 1910.

TRANSACTIONS OF THE SOCIETY.

VIII.—*Antipatharians from the Indian Ocean.*

By SOPHIA L. M. SUMMERS, M.A. B.Sc.

(Natural History Department, University of Aberdeen.)

(Read March 16, 1910.)

(PLATE V.)

THE Antipatharians here reported on were collected for the most part at Ibo, in Portuguese East Africa, by Mr. Jas. Simpson, M.A. B.Sc., Carnegie Fellow, University of Aberdeen. A few were collected in the Mergui Archipelago by Mr. R. N. Rudmose-Brown, B.Sc., and Mr. Simpson.

The collection includes fourteen species, of which three are new. The list is as follows.

EXPLANATION OF PLATE V.

- Fig. 1.—*Antipathes abies* Gray. Arrangement of spines, main axis.
,, 2.—*A. salicoides* sp. n. Arrangement of spines near the tip of the axis.
,, 3.—*Pteropathes simpsoni* sp. n. Arrangement of spines.
,, 4.—*Antipathes salicoides* sp. n. Arrangement of spines, main stem.
,, 5.—*Stichopathes bispinosa* nom. n. Arrangement of spines.
,, 6.—*Antipathes abies* Gray. Showing forked spines.
,, 7.—*A. salicoides* sp. n. Polyps on main branches.
,, 8.—*A. tristis* Duchassaing. Arrangement of spines.
,, 9.—*Cirripathes indica* sp. n. Arrangement of spines.
,, 10.—*Stichopathes bispinosa*. Polyps.
,, 11.—*S. echinulata*. Polyps.

June 15th, 1910

U

them. The large ones are blunt and rough, and those on the outer side of the spiral are much longer than those on the inner. The small or secondary spines are short, sharp, and triangular. Cooper has described (1909) a new species, *Stichopathes alcocki*, but his description of it corresponds with Brook's description of *Cirripathes diversa*, e.g. in the arrangement and form of the spines. Brook could not decide whether his specimen belonged to *Cirripathes* or *Stichopathes*, as it was quite devoid of polyps. Cooper remarks on the large size of the central canal. It is probable that *S. alcocki* Cooper should be united with *S. diversa* (Brook). The canal is well seen in this specimen, the wall of the corallum being comparatively thin.

Locality.—Portuguese East Africa. Previously recorded from Galle, Ceylon.

Stichopathes bispinosa nom. n. Plate V. figs. 5, 10.

= *Cirripathes* (?) *flagellum* Brook non = *Stichopathes flagellum* Roule.
See Brook, Report on the Antipatharia of the 'Challenger' Expedition,
p. 87, pl. xii fig. 13.

The longer of the two specimens is 130 cm. in length, and is twisted into large spirals with a diameter of 21 cm. The axis is stout and sinuous, and tapers gradually. The diameter at the base is 7 mm. It is covered with thin coenenchyma, through which the spines project. The polyps are confined to one side of the stem, and are quite different from those of other species. They are flat, with a small mouth overlapped by two of the tentacles. A little to the side are two other tentacles, and pushed down the side of the axis is a third pair. At first sight one would believe the polyps to have eight tentacles. So closely are the mouths situated, that it is difficult to discover to which polyp the tentacles belong. The tentacles are short and thick. The spines are arranged in longitudinal rows, nine of which can be seen from one aspect. They are very large (about 0.5 mm.), and they gradually decrease until exactly opposite the longest spines are the shortest (about 0.1 mm.). There are secondary spines scattered between the rows. The spines are distinctly papillose at the tip. Members of a row are about a length apart. The central canal is very large, having a diameter of 1.5 mm. The arrangement of the spines and the general characters of the specimen correspond exactly with Brook's description of *Cirripathes* (?) *flagellum*. As Brook's specimen had no polyps, he could not decide whether it should be referred to *Stichopathes* or to *Cirripathes*.

Locality.—Portuguese East Africa. Previously recorded from Ceylon.

Stichopathes echinulata Brook. Plate V. fig. 11.

See Brook, Report on the Antipatharia of the 'Challenger' Expedition, p. 92, pl. xii. fig. 9.

Of several specimens, the longest is 95 cm. It is twisted in irregular spirals. The axis gradually tapers to a fine point. The diameter at the base is 1 mm., and of the central canal 0.5 mm. The polyps are large and crowded on one side of the axis. In some of the specimens they show a peculiar mode of growth, being bunched together at intervals in a sort of hummock. The longest diameter of the polyp is 3 mm. The mouth is raised on a prominence 1 mm. in height. The tentacles are long and thin. The spines are numerous, and are arranged in steep spirals. Of the vertical longitudinal rows of the spiral, nine can be seen from one aspect. In one part of the stem the spines are short, triangular, and much compressed; at another part they are much longer. Members of a row are about three lengths apart.

Locality.—Portuguese East Africa. Previously recorded from Mauritius.

Stichopathes gracilis Gray.

See Brook, Report on the Antipatharia of the 'Challenger' Expedition, p. 90, pl. xii. figs. 17-19.

Two fragments, one 26.5 cm., the other 8 cm. The larger specimen is somewhat spirally coiled. The axis is black and tapering. At the base it is 2 mm. in diameter, at the tip 1 mm. The polyps are on one side of the axis, and are large and circular (2 mm. in diameter); the tentacles are short and thick; the mouth is prominent. The spines vary very much in different portions of the axis. In slender portions of the stem the spines are arranged spirally and in longitudinal rows. They are triangular and compressed and stand at right angles to the axis. In thicker portions the arrangement is less regular. Most are simple and have a sharp apex, but a few are forked at the tip.

Locality.—Portuguese East Africa. Previously recorded from Fiji, Red Sea, Seychelles, Ceylon.

Antipathes salicoides sp. n. Plate V. figs. 2, 4, 7.

The whole colony is like a miniature weeping-willow. The main stem, which seems to be broken, is only 10.5 cm. high. It is 2 mm. in diameter at the base, and gives off long tapering branches from one side, the first of which reaches a length of 32.5 cm. Some of these branches remain undivided, while others give off long slender twigs. The whole specimen is densely

covered with polyps, which are arranged alternately on the branches. They are large and circular; the mouth is prominent; the tentacles are short and thick—the two transverse ones lying a little below the level of the others. The diameter of the largest polyp is about 2 mm. The spines on the main stem are crowded, and do not all point in one direction—an unusual feature. They are arranged neither in rows nor in spirals. On the branches the spines are short, sharp, and triangular. They are arranged in longitudinal rows, seven of which can be counted from one aspect. The members of a row are about one length apart.

Locality.—Portuguese East Africa.

Antipathes furcata Gray.

See *Antipathes* (?) *furcata* Brook, in Report on the Antipatharia of the 'Challenger' Expedition, p. 104, pl. xi. fig. 2.

The main stem is broken, and is only 5 cm. in length. It gives rise to a branch which reaches the length of 8 cm., and is then broken. It in turn gives rise to a branch 23 cm. in length. The axis of this branch tapers very markedly, and gives off delicate branches on all sides and in no definite order. These are mostly directed upwards. The polyps, which are badly preserved, are elongated in the direction of the longitudinal diameter of the axis, and are twice as long as they are broad. They are about 1 mm. in length. They lie close together, but are not crowded. The tentacles are short. The spines are short, triangular, and compressed, and are far apart. They are arranged in longitudinal rows, six of which can be seen from one aspect.

Locality.—Portuguese East Africa. Previously recorded from Madeira.

Antipathes tristis Duchassaing. Plate V. fig. 8.

See *Antipathella* (?) *tristis* Brook, Report on the Antipatharia of the 'Challenger' Expedition, p. 111.

A small delicate colony 5 cm. high. The stem is slender, and gives off delicate branches irregularly at right angles to the stem. Anastomoses occur, but are not frequent. The polyps are situated on one side of the axis. They are small, and have short digitiform tentacles. The polyps are about 1 mm. apart. The spines are sharp and triangular, and are arranged in irregular longitudinal rows, six of which can be seen from one aspect. Members of a row are about two lengths apart.

Locality.—Portuguese East Africa. Previously recorded from Guadeloupe, Santa Cruz, Montserrat, Martinique, St. Lucia, and Barbadoes.

Antipathes lentipinna Brook.

See *Antipathes* (?) *lentipinna* Brook, Report on the Antipatharia of the 'Challenger' Expedition, p. 103, pl. xi. fig. 19.

A shrub-like colony 28 cm. high, densely branched. The main axis is black and hard, 7 mm. in diameter. In the branches and pinnules the axis is light brown. The polyps are arranged on one side of the axis, and are large (2 mm. in diameter) and crowded together. Here and there small polyps are crowded in between the large ones. Branches are given off, usually from one side only. On the main stem the arrangement of spines is very irregular. The axis is flattened out, and the spines are scattered all over it, but on the branches they are arranged in regular spirals and longitudinal rows, five of which can be seen from one aspect. The spines are long and triangular, and are very close together.

Locality.—Portuguese East Africa. Previously recorded from the Red Sea.

Antipathes gracilis Gray.

See *Antipathella* (?) *gracilis* Brook, Report on the Antipatharia of the 'Challenger' Expedition, p. 113, pl. xi. fig. 8.

Two specimens, one 8.5 cm. in height, and the other a little over 9 cm. The latter is a delicate colony, with no regular mode of branching. The branches are thin and short, and are given off at right angles. Anastomoses are frequent, but the terminal fronds are free. The polyps are crowded together on one side of the axis. They are circular, 1.5 mm. in diameter. The tentacles are short and thick, one pair lying slightly below the level of the other two pairs. The spines are long and numerous, and are arranged in spirals and longitudinal rows, five of which can be seen from one aspect. Members of a row are from two to three lengths apart.

Locality.—Portuguese East Africa. Previously recorded from West Indies and Madeira.

Antipathes abies Gray. Plate V. figs. 1, 6.

See *Antipathes abies* Brook, Report on the Antipatharia of the 'Challenger' Expedition, p. 70, pl. xi. fig. 21.

The four specimens show a remarkable difference in the mode of growth. The first specimen, from Five Islands, consists of two fragments, much-branched and bearing many polyps. Some of the polyps are very well preserved, and show a prominent mouth raised

on a cone, and long tentacles. The polyps are arranged close together on one side of the stem, and are relatively large. The cœnenchyma is thin, and the spines can be seen projecting through it. The spines are very numerous. On the lower part of the stem they are sharp and needle-like, and stand out at right angles to the axis, but on the branches they are small and blunt, and lean towards the axis. The second specimen is 16 cm. in length. The mode of branching is the same as in the first case. The branches are given off all round. The main axis is thick. The polyps are situated on one side of the axis, and are crowded. They are 0·5 mm. in the longest diameter. The mouth is slit-like and prominent. The tentacles are much contracted, and are placed in three pairs round the mouth. The spines are exactly of the same type as those of the first specimen.

Locality.—Portuguese East Africa.

The third specimen branches in one plane and is fan-like. The main axis is thick and flattened out at the base, and gives off alternate branches. The polyps are similar to those of the second specimen, but are far apart, being separated on some parts of the axis by intervals of fully 0·5 mm. The spines are of the same type as in the previous specimens, but are not so long on the stem.

Locality.—Portuguese East Africa.

The fourth specimen is from Bentiuck Island, Mergui. It is similar to the last specimen in being fan-like, but the branches are smaller and more delicate. It is 12·5 cm. high. The polyps are crowded together on the branches, and the largest have a diameter of 0·5 mm. The cœnenchyma is very thin. The spines agree with those of the other specimens, but the needle-like spines on the axis are very numerous. It seems that *Antipathes abies* is a very variable species.

Pteropathes simpsoni sp. n. Plate V. fig. 3.

A small colony, 10·5 cm. in length. The branching is irregular, and there seems to be no main axis. The whole specimen is clothed on one side with whitish polyps, which give it the appearance of being covered with a mould. These polyps are unfortunately so badly preserved that their structure cannot be made out, though in some parts long tentacles are seen. The spines, which are large and numerous, are triangular with a broad base. They are arranged in very steep spirals; seven or eight can be seen from one aspect. Towards the tip of the axis the spirals become irregular. The spines also form longitudinal vertical rows, the members of which are about a length apart, and in some places even less.

Locality.—Mergui Archipelago.

LITERATURE REFERRED TO—IN ADDITION TO THAT NOTED BY
BROOK (1889) AND ROULE (1904).‡

1889. BROOK, G.—Antipatharia. 'Challenger' Report, xxxii. 222 pp., 15 pls.
1903. COOPER, C.—Antipatharia. In Gardiner's Fauna and Geography of the Maldive and Laccadive Archipelagoes, ii. pp. 791-6, 1 pl.
1903. ROULE, L.—La distribution bathymétrique des Antipathaires. C.R. Ass. Franc., 31 Sess., p. 236.
1904. ROULE, L.—Resultats Comp. Sci., par Albert I. de Monaco, Fasc. 30, pp. 6-99, 10 pls.
1905. THOMSON, J. ARTHUR—Scotia Collections, Scottish Antarctic Expedition. Report on the Antipatharians. Proc. Roy. Phys. Soc. Edinburgh, xvi. pp. 76-9.
1905. THOMSON, J. ARTHUR, & J. J. SIMPSON—Report on the Antipatharia, in Herdman's Ceylon Pearl Oyster Fishery Reports, Royal Society, iv. pp. 93-106, 1 pl.
1907. ROULE, L.—Sur la valeur morphologique des épines du polypier des Antipathaires. Comptes Rendus, 1907, pp. 1533-4.
1907. THOMSON, J. ARTHUR—Note on a large Antipatharian from the Faroes. Proc. Roy. Phys. Soc. Edinburgh, xvii., 1 pl.
1907. HICKSON, S. J.—Alcyonaria, Antipatharia, and Madreporaria collected by the 'Huxley' from the north side of the Bay of Biscay, in August 1906. Journ. Marine Biol. Assoc., viii. No. 1.
1909. COOPER, C.—Antipatharia of the Percy Sladen Trust Expedition to the Indian Ocean. Trans. Linn. Soc. London (Zool.) vii. pt. 4, pp. 301-21, 1 pl.
1909. SILBERFELD, E.—Japanische Antipatharien. Abhandl. der Math.-Phys. Kl. der k. Bayer. Akad. Wiss., i. Supp. 1, Bd. 7, Abhandlg. pp. 4-30, 2 pls.

IX.—*Critical Microscopy.*

By EDWARD M. NELSON.

(Read April 20, 1910.)

FROM time to time requests are received for information as to the method of procedure for obtaining a critical image. As the publications upon this subject are much scattered—e.g. some being in back numbers of the *English Mechanic*,* not always accessible, and some in this and the *Quekett Microscopical Club Journals*, while some are included in papers upon other microscopical subjects—it is therefore not always easy to give correspondents suitable references which they can find. Several times I have been requested to publish a description of the whole method, so that it may be readily available in a single reference; to this I now accede, the more readily as the method is so simple that it can be explained in a few words, by which much future trouble will be saved both to correspondents and myself.

When, in the early seventies, I began microscopical work, the leading Microscope makers supplied in the box with the Microscope a whole drawer full of various illuminating apparatus, which at that time was considered necessary in order to obtain the best results. I well remember going through all these various appliances and practising so as to be proficient in the manipulation of each of them; but when in 1875 the advantage of the large axial cone was perceived, all this apparatus was abandoned, with the exception of the achromatic condenser, a silver side reflector, and a few *lieberkühns*.

It is now difficult for us to realise the position of "Microscopy" at that date. Student's Microscopes, for example, hardly ever had a substage-condenser; it was considered right that they should have at least a wheel of diaphragms, but some did not have even that. An examination of twenty-three Student's Microscopes of that time showed that only one was fitted with a substage-condenser (Webster's); another, a Ross No. 3, had a fitting to carry a substage. The better class of those instruments were capable of having a substage fitted, but a substage together with a substage-condenser was always looked upon as an accessory, much in the same way as we to-day regard a polarising prism, or a revolving selenite holder. An authority of that time writes:—"The stage

* *English Mechanic*, xxxviii., xxxix., xl. (1883) No. 977 (1884) Nos. 980, 986, 1017, 1021, 1027.

should be fitted with a diaphragm, and there should be a substage or tube for receiving the accessory apparatus, condenser, etc., which may afterwards be added." This shows that in the writer's opinion a substage-condenser is not regarded as a necessity, but rather that it falls under the category of a polariscope, spot-lens, or paraboloid.

In those days no one ever thought of tackling diatom structure without oblique light, and Grubb and Sollitt's methods* of a swinging substage were revived. Microscopes were constantly appearing with some new variety of swinging substage, but by that time my mind with regard to the large axial cone was fully made up, and a swinging substage, however well designed or beautifully made, never became an allurements to me.

The *Amphipleura pellucida* had just been resolved, and the true number of the striæ both seen and counted for the first time by Messrs. Powell and Lealand with their new superstage oblique illuminator,† a piece of apparatus still kept in my cabinet as a curiosity (a device which has lately again come into notice in the form of Dr. Siedentopf's method‡ of side illumination).

There were also the beautiful photographs by Colonel Woodward both of *Amphipleura* and Nobert's bands taken by sunlight passed through a blue screen and used oblique.§ Just at this time too there began to be published in the microscopical literature of this country Professor Abbe's spectrum theory of microscopic vision,|| which showed that the resolution of periodic structures depended upon the manufacture of a spectrum at one side of an object glass by an oblique beam at the other. It was no wonder then that with all this evidence in favour of oblique light, brought forward by the leaders of microscopical science, I and my large axial cone had a bad time of it. But repeated exhibitions of objects shown by means of the large axial cone at the meetings both of this Society and of the Quekett Microscopical Club bore fruit, so by degrees less and less was seen of swinging substages and oblique light illuminators, and gradually critical illumination was adopted by those doing the highest class of microscopical work. When the controversy was at its height in 1888 a photograph of *Pleurosigma angulatum* taken by means of a small axial cone was published ¶ by Messrs. Zeiss, and in the next year Professor Abbe

* Quart. Journ. Micr. Sci., iii. (1855) p. 87. See also this Journ., iii. (1880) pp. 1055-80. (In the list on p. 1055 Sollitt's Microscope is omitted.)

† Monthly Micr. Journ., i. (April 1869) pp. 315, 319.

‡ See this Journal, 1903, p. 573.

§ Monthly Micr. Journ., xviii. (1877) p. 61; Op. cit., i. (1878), p. 246, and ii. (1879) p. 769, figs. 5, 6.

|| First notice, Monthly Micr. Journ., xii. (1874) p. 29. Full account, see this Journal, 1881, pp. 303-60. (For Bibliography see 1879, p. 651.)

¶ Published as a leaflet, and widely distributed; also in Catalog für Mikro-photographie, by Dr. Roderich Zeiss, 1888.

published a paper condemning the wide-angled cone.* This photograph, afterwards withdrawn, was taken with one of the new oil-immersion apochromatic $\frac{1}{2}$ and an electric arc lamp, and with all the resources of the Zeiss factory at the operator's hands, yet it showed not an iota of advance upon results obtained thirty years previously with dry achromatic objectives.† In brief it was, as I said at the time, a repetition of Reade's "plate of marbles."‡ When a wide-angled axial cone is used the hemispherules or marbles disappear and in their place is seen the true structure, which is a piece of siliceous sieve or net. Under the large cone so sensitive does the object-glass become that it is possible to cut optical sections, and visually separate the upper net from the lower net. Those who in this manner have studied this diatom are able to tell you from a slight difference in appearance whether you are looking at the outside or inside net. With the narrower cone there is indeed "a plate of marbles," but no one would have the slightest suspicion that there were two plates, each capable of holding their own marbles; and as for recognising any minute difference between the two nets, it is quite impossible with a small cone to see any net at all with any lens, however perfect. With a small-angled cone the benefits both of apochromatism and of large aperture are entirely thrown away, and a really fine objective is degraded to one of common place. This example of *P. angulatum* has been selected for illustration, as it was a well-known case, and will be remembered by some. Mr. T. F. Smith, who was then working on the *Pleurosigma*, exhibited before this Society some very beautiful photomicrographs in illustration of his theories as to the structure of this genus. His system of illumination differed from mine, as he used a bullseye in conjunction with a dry achromatic condenser, which gives what may be called annular illumination, the back of the object glass having the appearance shown in K (fig. 46), which is not a large solid axial cone such as mine shown in B. His method, by whatever name it is known, was the very antithesis of the Abbe small cone, and, like mine, was adversely criticised at that time by those who upheld Professor Abbe's views upon the subject. Of the photomicrographs which have been produced, and of the objects which have been exhibited under small cone illumination, none may be said to present structures minute enough to be considered difficult microscopical images. The work which would be suited to low-power lenses of medium capacity under large cone illumination requires under small cone illumination high-power lenses of the greatest capacity. Nearly a quarter of a century has now elapsed, and we are still

* See this Journal, 1839, p. 721.

† See Hogg on the Microscope, 2nd ed., 1855, p. 152, fig. 99.

‡ Rev. J. B. Reade, F.R.S., President R.M.S., Monthly Micr. Journ., ii. (1869), p. 5.

waiting to see some results worthy of that theoretically perfect method of microscopical illumination.

Critical Image.—The image of an object is critical when it is obtained by means of an objective of fine quality which has been

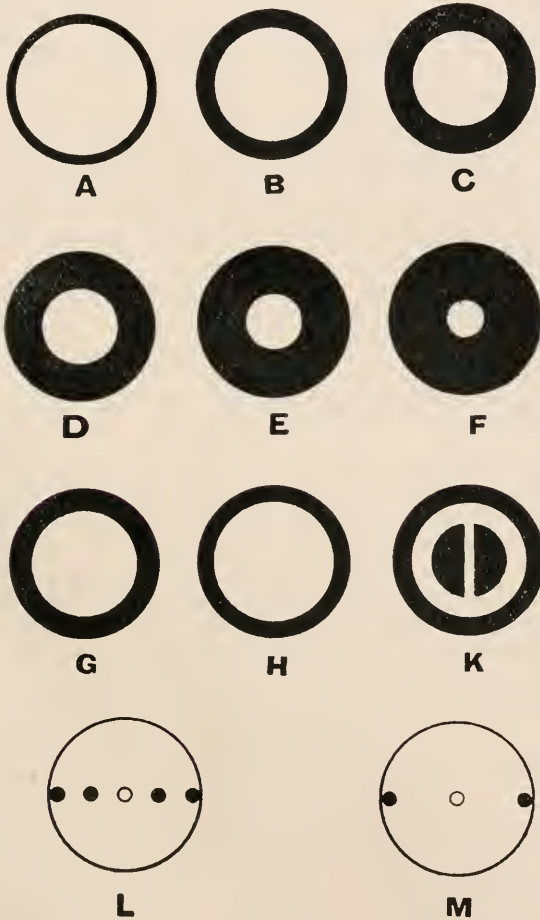

FIG. 46.

placed in correct adjustment for that object by its screw collar, or by the alteration of the tube length, and when the illumination is critical.

Critical Illumination.—An object is said to be illuminated critically when it is placed at the apex of a solid axial cone, the

aperture of which is not less than three-quarters of the N.A. of the observing objective (B).

To arrange a Microscope for Critical Illumination.—1. Place a low power, say a 1-in., $\frac{2}{3}$ -in. or $\frac{1}{2}$ -in., upon the nose-piece, an object upon the stage, and a condenser in the substage. Incline the Microscope and point it directly at the source of light, which should be the edge of the flame from a $\frac{1}{2}$ -in. wick of a paraffin lamp. Fill the field with any kind of light by racking down the condenser, and bring the object, or a well-marked part of the object, to the centre of the field.

2. Close the iris-diaphragm, or if there is not one place a diaphragm with a small hole in it beneath the substage condenser, and rack the condenser so that the image of this hole is focused upon the plane of the object on the stage, and by means of the substage centring screws bring the image of this hole central with the centring object.

3. Rack up the condenser further until the source of light comes into focus in the plane of the centring object. If the source of light does not happen to be central with the centring object, the lamp must be moved so that the image of the source of light shall be superimposed on the centring object. (On no account must the centring screws of the substage condenser be used for this purpose, only the lamp must be moved.)

4. Remove the low power used for centring and place the object glass which is going to be used on the nose-piece. If the object and the image of the source of light are not central to the new field, first place the centring object central to the new field, and then by means of the substage centring screws bring the image of the source of light central to it. (On no account must the source of light be moved for this purpose.)

5. The eye-piece is now removed, and the back lens of the objective is examined by looking down the Microscope body. Open the iris, or other diaphragm, until it is seen that three-quarters of the back lens of the object glass is full of light, as in B. *Note.*—A disk of light as in B cannot be obtained unless the aperture of the substage condenser is aplanatic to that extent.

6. It is usual to go over Nos. 2 and 3 a second time; thus, when in (3) the lamp has been moved so that the image of the edge of the flame is central with the centring object, rack down the substage condenser until the diaphragm hole comes into focus, and note if it is still central to the centring object, if not re-centre it by means of the substage centring screws. Next rack up the substage condenser until the image of the edge of the flame is in focus, and if necessary re-centre it to the centring object by moving the lamp.

If it is necessary to use a Microscope in a vertical position, the above procedure should be gone through with the image of the

edge of the flame reflected from the plane-mirror; it is, whenever possible, far simpler and more satisfactory to work with the lamp direct.

All this centring operation may be performed in less than 30 seconds, and a practised manipulator will not require to use a low-power objective, but will employ for this purpose the objective he is going to use for observation.

Anyone wishing to become acquainted with the elementary practice of critical illumination must learn by heart the appearance of the figures A, B, C, D, E and F. These figures represent the back lens of a Microscope objective when the illumination is central, as seen either when the eye-piece is removed or by an inspection with a magnifying lens of the Ramsden disk, which appears as a spot of light just above the eye lens. This Ramsden disk is a diminished image of the back lens of the objective. The higher the power of the eye-piece the greater is this diminution. The following table explains the figures:—

Figure.. .. .	A	B	C	D	E	F	G	H
Cone	$\frac{7}{8}$	$\frac{3}{4}$	$\frac{5}{8}$	$\frac{1}{2}$	$\frac{3}{8}$	$\frac{1}{4}$	$\frac{1}{1.41}$	$\frac{1}{5}$
W.A. (working aperture) is N.A. of objective multiplied by875	.75	.625	.5	.375	.25	.707	.8
Illuminating power is that of the whole objective multiplied by766	.562	.391	.25	.141	.0625	.5	.64

Example.—*P. angulatum* is placed underneath an apochromatic $\frac{1}{2}$ in. of N.A. 0.65. With a cone as at D a false resolution of the diatom is seen, the image being lines crossing one another at an angle of 60°. When the W.A. is increased to H a true image, so far as it goes, is obtained. It consists of isolated black dots, each hole in the network being represented by a black dot.* The $\frac{1}{2}$ in. must be a good lens to give a sharp picture of this view of the object under these conditions.

A novice will probably call the figures A, B and H hair-splitting, but if he tries them he will find a much greater difference in the quality of the image than he imagined. Now, G shows an objective divided into equal areas, the area of the annulus being precisely equal to that of the central disk, therefore half the illuminating power of the whole objective resides in that narrow black annulus; then as the black annulus in A represents less than one quarter of the illuminating power of the whole objective, it follows that

* The following measurements very carefully performed with a long-tube oil-immersion $\frac{1}{2}$ in. may be of interest. Transversely the rows of dots count 45,260 per in., diagonally in both directions 45,720 per in. The mean of the three directions being 45,490 per in. or 1791.5 in mm.

the difference between the annulus in A and that in G amounts to more than 25 per cent. of the illuminating power of the whole objective.

If any black dots should appear in the disk, as at K, the learner must understand that either his substage condenser is racked up within its focus, or if in focus there must be spherical aberration somewhere in his illuminating beam. It may be that his substage condenser is defective, or a bullseye has been placed between the source of light and the substage condenser and not properly focused so as to give parallel rays.

It was mentioned above that Mr. Smith's annular illumination, K, differed from mine. This kind of illumination is very likely to double periodic structures. The following test should be applied when this kind of illumination is used.* Illuminate the periodic structure by means of a very narrow axial cone, an objective of wide angle being used. *Example.*—Let the objective have an aperture of N.A. 1.0, and let its back lens appear as in L, where we see that the four diffraction beams are 0.25 N.A. apart; consequently we know that the structure under this objective must have a periodicity of about 24,000 per inch. Now, if by manipulating the illumination, or by introducing spherical aberration into the objective by means of an improperly adjusted tube-length, a structure of 48,000 per inch is resolved, it should be recognised at once that this resolution must be false; for if the structure had had a periodicity of 48,000 per inch the back lens of the objective would have presented an appearance as in M, and certainly not as in L.

This test consists, then, in roughly measuring in terms of the estimated N.A. the angular divergence of beams diffracted by periodic structures; then by means of the table, printed on the fly-leaf of this Journal, the periodicity of the structure will be found. It is obvious that the scheme of this test may be extended by making the narrow illuminating beam so oblique that it touches the edge of the back lens; then if there are two spectra their distance apart will be 0.5 N.A., and the structure will be 48,000, but if only one, then it will be 96,000; if the separation is equal to about two-thirds of the back lens, then the structure would be 60,000, and so on. Of course, if the objective used for the test has some N.A. other than 1.0 N.A., its N.A. must be multiplied by the fraction, whatever it may be, as in the W.A. in the above table. This test has obviously nothing whatever to do with the Abbe theory, because the physical fact that light in passing through a minute grating is bent off at a certain angle, which depends on the fineness of that grating, was known before Professor Abbe was born; therefore any one could have employed the aperture of an

* Bristol Naturalists' Society, viii. pt. 2 (1897) p. 163.

object-glass as a rough means of determining this angle of deflection, and hence the fineness of the grating (apart from any resolution of it) before the Abbe theory had been published. This test may be applied not only to rulings, but also to diatoms, such as *Naviculaceæ*, *Pleurosigma*, *Nitzschia*, *Schizonema*, etc., but of course not to *Aulacodisci*, *Eupodisci*, *Aulisci*, *Coscinodisci*, *Isthmia*, *Triceratia*, etc., for in these latter examples the whole of the back lens is flooded with light, and that is the reason why they are more suitable than any other objects for testing objectives.

The examination of bacteria upon a dark ground is a plan now much used; this I advocated in 1884 at the Quekett Microscopical Club for the purpose of "saving the eyes from the woful glare of the direct light, and to enable the objects to be much more easily detected." With this kind of illumination the whole area of the objective is utilised, and those who have selected their lenses by a bacterial test and a small cone now find that their lenses break down with this dark-ground illumination, so they are having stops made to cut off the fluffy margins of their lenses so that they may use them with reduced apertures.

X.—On the Measurement of the Diameter of the Flagella of the Cholera Bacillus prepared by Löffler's Method.

By A. A. C. ELIOT MERLIN.

(Read March 16, 1910.)

SLIDES of bacteria intended to render the flagella demonstrable even under the highest powers of the modern Microscope are almost invariably prepared by Löffler's, or some similar method, which greatly distends the organism and its appendages, thus rendering them comparatively coarse objects. It has been said that the reason why flagella are (supposedly) invisible in the ordinary balsam-stained preparations is because these appendages then fall alongside the microbes. As a matter of fact, it has long been known that flagella are readily observable in such slides under proper optical conditions.

Little or nothing seems to have been attempted as regards the measurement of the diameter of these delicate appendages since the late Dr. Dallinger read his famous paper "On the Measurement of the Diameter of the Flagella of *Bacterium termo*: a Contribution to the Question of the 'Ultimate Limit of Vision' with our present Lenses."* Dr. Dallinger made four sets of fifty separate drawings and measurements with each of four lenses ($\frac{1}{12}$, $\frac{1}{14}$, $\frac{1}{25}$, and $\frac{1}{35}$ in.), and taking the mean of these two hundred measurements found 0.00000488526, or nearly $\frac{1}{204700}$ in., to be the value of the diameter of the flagellum of *B. termo*. We now know that this value requires antipoint correction, which makes the true diameter of the flagellum 0.00000993 ($\frac{1}{100700}$ in.), assuming that the W.A. was 0.8.† In truth, a flagellum possessing such a thickness should prove readily visible with a N.A. of 0.5, and thus be well within the grasp of an ordinary good $\frac{1}{4}$ in. of the period (my Powell $\frac{1}{4}$ in., made in 1850, has N.A. 0.72, and will stand a large W.A.). Nevertheless, we can imagine the incredulity that would have found open expression had anyone calmly stated at the time that the flagella of *B. termo* could be readily perceived with such an objective!

At the present day lenses of N.A. 1.3 and 1.4, in the hands of trained professional bacteriologists, are apparently insufficient to demonstrate the existence of the flagella of *B. tuberculosis* and *M. melitensis*, although both are visible under proper optical conditions with a dry objective in ordinary balsam well-stained slides.

* See this Journal, 1878, p. 169.

† Op. cit., 1903, p. 581.

Under these circumstances it has been thought that a measurement of the diameters of the cholera bacillus flagella, prepared by Löffler's method, may be of service if only to render manifest the real dimensions of appendages commonly considered delicate objects entailing the employment of the highest powers for their successful demonstration. Recent advances in practical microscopy render it easy to ascertain the true diameter of flagella with great precision and little labour; a suitable objective, with a Royston-Pigott * iris diaphragm above it, and an Abbe apertometer being needed for the purpose. In the present instance extinction measurements † were effected with an apochromatic $\frac{1}{2}$ in. of 20.2 I.M.P. and N.A. 0.70, and an apochromatic nominal $\frac{2}{3}$ in. of 18.6 I.M.P. and N.A. 0.35. With both these lenses it was found that the very finest flagella in the Löffler slide were extinguished with a clear N.A. of 0.25 and the coarser at N.A. 0.24, a full illuminating cone and Gifford F line screen being employed. It is thus apparent by the table on p. 550 of the Journal (1909) that the finest flagella possess a diameter of 0.00001545 ($\frac{1}{64725}$) in., the coarser equalling 0.00001606 ($\frac{1}{62266}$) in. Some few of the coarsest appendages even slightly exceed the latter diameter. All the flagella are beautifully shown under a semi-apochromatic 1 in. of 12.1 I.M.P. and N.A. 0.28, used critically with a screen.

An excessively slight closing of the Pigott diaphragm produces invisibility of the flagella when the critical point is reached. It is necessary that the clear N.A. should be very exactly ascertained by means of the Abbe apertometer preferably used on a revolving divided stage as described in "Carpenter" (eighth edition, p. 395), and fully explained in this Journal (1896, p. 592). For the definite extinction of most structures it will be found necessary to reduce the N.A. in the manner described, i.e. by employing a full illuminating cone and cutting down the objective's aperture by means of a diaphragm placed immediately above it. The proper extinction point cannot be exactly ascertained with an objective of large N.A. by merely closing the condenser diaphragm and thus reducing its W.A., it having been found in practice that the presence of flagella is indicated, when this method is employed, by vague diffraction effects long after the true extinction point is passed. It is, therefore, necessary or advisable to always substitute clear N.A. for W.A. in effecting extinction measurements by the table given in this Journal (1909, p. 550). I am able to state that Mr. Nelson fully concurs in this view.

Addendum.

As a check on the accuracy of the above described extinction measurements, it was thought desirable to ascertain, if possible, at

* Monthly Micr. Journ., xiii. (1875) p. 56.

† See this Journal, 1909, p. 549.

least approximately, the diameter of these flagella by means of the filar micrometer, and in consequence of the comparatively very considerable thickness of such distended filaments it proved feasible to do so, and to obtain results closely confirming those yielded by extinction. A bacillus having a long and clean flagellum was selected for the purpose, a Powell $\frac{1}{2}$ -in. objective being employed with amplifier (thus practically converting it into a $\frac{1}{30}$ of N.A. 1.27) together with a special Nelson-Powell micrometer having a traversing screw-setting frame and 10-compensating ocular. With this combination the selected flagellum (one of the finest on the slide) appeared broad and coarse, the spider lines being in comparison extremely fine. It was found that when the upper edge of the "fixed" wire was accurately adjusted by screw to just touch the lower edge of the flagellum, it required a revolution of the drum through twenty-one divisions to bring the top edge of the moving wire in contact with the upper edge of the flagellum, one drum division being equal to $\frac{1}{194} \frac{1}{7166}$ in. This gives a value of 0.00001079 in. for the flagellum in question, which, however, requires antipoint augmentation* of 0.00000425 in. for the W.A. 0.875, thus making the true diameter 0.00001504, or $\frac{1}{66489}$ in., as against the extinction $\frac{1}{64725}$ in. for flagella of approximately similar fineness. In consequence of these results I venture to submit there can be no reasonable doubt regarding the practical efficiency of the extinction method when dealing with smaller objects so minute as to absolutely defy accurate measurement in any other manner, even with the most refined appliances.

* See this Journal, 1904, p. 271.

SUMMARY OF CURRENT RESEARCHES

RELATING TO

ZOOLOGY AND BOTANY

(PRINCIPALLY INVERTEBRATA AND CRYPTOGAMIA),

MICROSCOPY, ETC.*

ZOOLOGY.

VERTEBRATA.

a. Embryology.†

Alleged Influence of Electric Discharges in Inducing Parthenogenesis.‡—Yves Delage has come to the conclusion that electric discharges do not in themselves induce parthenogenetic development. Apart from electrolytic effects, an electric current has no influence in this connection. Electrolysis has a feeble influence as a factor in parthenogenesis, through the acids and alkalis formed at the electrodes. Minimal quantities of metallic salts very injurious in slightly larger doses, e.g. sulphate of copper and chloride of zinc, are active agents in parthenogenesis. Their activity is notably increased by a slight acidification. Various substances without acid or alkaline reaction, in particular formol and alum, are active parthenogenetic agents, and acidification helps. The same is true of almost infinitesimally small doses of colloidal hydrate of iron. Delage adheres to his view that the artificial inducing of the formation of a vitelline membrane, and the dissolution of the nuclear membrane, sets the egg developing parthenogenetically.

Vitelline Membrane in Egg of Birds.§—A. Lécaillon has studied the egg of the blackbird in this connection. He finds that the so-called vitelline membrane has three layers. The innermost shows no cellular structure; the middle one is an epithelium in process of degeneration; the outermost one consists of fibrillar connective-tissue. In the advanced ovarian ovum there is a follicle with these three layers just as in the laid egg. Thus what is called the vitelline membrane consists of part of the follicular theca, and would be better called vitelline capsule.

In another paper|| he gives minute data in regard to the structure

* The Society are not intended to be denoted by the editorial "we," and they do not hold themselves responsible for the views of the authors of the papers noted, nor for any claim to novelty or otherwise made by them. The object of this part of the Journal is to present a summary of the papers *as actually published*, and to describe and illustrate Instruments, Apparatus, etc., which are either new or have not been previously described in this country.

† This section includes not only papers relating to Embryology properly so called, but also those dealing with Evolution, Development, Reproduction, and allied subjects.

‡ Comptes Rendus, cxlix. (1909) pp. 890-6.

§ Op. cit., cl. (1910) pp. 240-2.

|| C.R. Soc. Biol. Paris, lxxviii. (1910) pp. 218-19.

of the vitelline capsule, which includes (1) an internal layer, the vitelline membrane of the ovarian ovum; (2) a median layer, the remains of the granulosa of the ovarian follicle; and (3) an external layer, the most internal part of the theca of the ovarian follicle.

Polynuclear Ovum in Bat.*—A. Guieysse-Pellissier describes in *Vesperugo abramus* a strange kind of abortive ovum, which has become polynuclear through the immigration of adjacent cells derived from the granulosa and of leucocytes.

Double Egg in Porbeagle Shark.†—A. Vayssière describes a double egg in the left oviduct of *Lamna cornubica*. The separate developing ova were enclosed in a single shell, which was too large to be expelled.

Egg of Rhinophis.‡—L. Baumeister describes the egg and embryo in *Rhinophis trevelyanus*. The number of eggs that develop at one time is reduced to two (in adaptation to subterranean life and viviparous birth at an advanced stage); they occur only in the left oviduct; the egg-envelopes are extremely delicate and without calcareous encrustation; the shape of the eggs is an elongated cylinder.

Mitochondrial Elements of Germ-cells and Chondriosomes of Embryonic Cells.§—J. Duesberg has succeeded in the rabbit in demonstrating the continuity of the mitochondrial elements of the ovum and the chondriosomes of the somatic cells of the young embryo, thus showing the maternal origin of at least some of them.

Development of Autonomic Nervous Mechanism of Birds' Alimentary Canal.||—Williamina Abel finds that the whole sympathetic system is secondary in formation to, and directly derived from, the central nervous system. The abdominal sympathetic is produced by the migration of cells from the spinal cord and intervertebral ganglia downwards through the mesentery to the gut. From these cells are formed the various divisions and synapses of the autonomic system. That these cells are not the sheath-cells described by Harrison as growing from the posterior root in the tadpole is indicated by some of their number subsequently forming the cells from which the two plexuses in the intestinal wall develop.

Development of Lymphatic Ganglia of Duck.¶—J. Jolly finds that, while the typical lymphatic ganglia of Mammals are formed by the growth of a mesenchymatous nodule between the lymphatics crowded at the periphery and forming the marginal sinus, those of the duck develop by the progressive partitioning of a lymphatic vessel, mesenchymatous buds growing in on the cavity at short intervals. Associated with this, there is an invasion of adjacent adipose lobules by the lymphoid tissue, an extension of the spongy substance and of the sinus network by accessory lymphatics and by budding of sinuses.

* C.R. Soc. Biol. Paris, lxxvii. (1909) pp. 692-4.

† Tom. cit., pp. 872-3.

‡ Zool. Jahrb., xxviii. (1910) pp. 603-10 (6 figs.).

§ Anat. Anzeig., xxxv. (1910) pp. 548-53 (4 figs.).

|| Proc. Roy. Soc. Edinburgh, xxx., pp. 327-47 (4 pls.).

¶ C.R. Soc. Biol. Paris, lxxvii. (1909) pp. 684-6.

Role of Vagi in Development of Sympathetic Nervous System.*

Albert Kuntz has made observations on embryos of the pig which lead him to conclude that the primordia of the myenteric and submucous plexuses, the pulmonary plexuses, and the cardiac plexus, have their origin in nervous elements which migrate from the vagus ganglia and the walls of the hind brain along the paths of the vagus nerves.

Cranial Nerves of Pike.†—B. A. Panschin comes to the following conclusions. The olfactory is a visceral-sensory nerve, whose segmental nature is obscure. The optic presents no peculiarity. The oculomotor is a somatic-motor nerve, except as regards a new ciliary ramus of unknown nature. The trochlear and abducens are purely somatic-motor and present no peculiarity. The trigeminus i. is an incomplete segmental nerve, somatic-sensory in nature, probably associated with the first post-oral gill-cleft. It is to be distinguished from the complete segmental nerve trigeminus ii., associated with the præ-spiracular cleft. In spite of the disappearance of the spiracle in Teleosteans, the facial is its complete segmental nerve. The glossopharyngeal is an incomplete segmental nerve of the first gill-cleft: it has lost two branches. In the vagus group are included two non-segmental and at least three segmental nerves. The acustico-lateralis complex has three ganglia.

Development of Alimentary Canal in Lepidosiren and Protopterus.‡—J. Graham Kerr gives the following summary of the results of his investigation. The fore-gut first becomes folded off from the main mass of yolk-cells. The pyloric valve arises by the hind end of the fore-gut being pushed back into the cavity of the mid-gut. The main mass of yolk-cells becomes gradually "modelled" into a spirally coiled intestinal rudiment. The main part of the buccal lining is developed in situ from large yolk-cells.

The part of the ventral side of the head, on which are the olfactory rudiments, becomes enclosed in the buccal cavity by the development of the upper lips and by the forward growth of the lower jaw. The olfactory opening becomes divided into anterior and posterior nares by the apposition and fusion of the intermediate portion of its lips.

The thyroid arises as a solid downgrowth from the bucco-pharyngeal floor, which gradually becomes cut off from behind forwards. The tongue is a primary tongue like that of Urodeles, but without gland-field. The pancreas arises from a dorsal and two ventral rudiments.

The lung arises from a solid mid-ventral rudiment. When the lung becomes bilobed, the (actual) right lobe is for a time small in size as compared with its fellow. Complicated torsional processes take place during the development of the lung. Through the dorsal mesentery becoming partially merged in the splanchnocœle roof, the lungs come to be outside the splanchnocœle. The general facts of lung development go to support the view that the lung of *Polypterus* shows a persistence of the condition ancestral to that of Dipnoi and Actinopterygii.

* Anat. Anzeig., xxxv. (1909) pp. 381-90 (4 figs.).

† Tom. cit., pp. 443-67 (7 figs.).

‡ Journ. Quart. Micr. Sci., liv. (1910) pp. 483-518 (13 figs.).

Hermaphroditism in Toads.*—O. Fuhrmann examined 91 male toads in the month of April, and found that 11 were in some degree hermaphrodite. There may be slight hermaphroditism in the gonads or in the ducts, or there may be potentially, if not also effectively, functional autogamy.

Reproductive Organs of Free-martin.†—D. Berry Hart discusses the nature of a free-martin, which is an apparent sterile twin cow, usually co-twin with a potent bull. It has, in this case, the lower part of its genital tract to the naked eye like that of a cow, the upper part defective, and it is usually considered as a cow sterile from incomplete development of its upper vaginal and uterine tract. The author dealt with thirty recorded cases and with John Hunter's specimens, and finds that the free-martin, when the co-twin is a potent male, is a sterile male, and not a sterile female, i.e. they are identical male twins, except in their genital tract and secondary sexual characters. There is no trace of ova, the gonads are testes, and an epididymis is present. The potent and sterile twins arise from one zygote; "the somatic determinants are equally divided, the genital determinants unequally divided, the potent going to the one twin, the potent bull, the non-potent genital determinants to the free-martin." The potent organs are dominant, the non-potent recessive, and a Mendelian interpretation is possible. The free-martin is a pure or extracted recessive *quâ* its genital determinants, and the potent twin a pure or extracted dominant.

Leuco-reaction in Pregnancy.‡—Ch. Achard, Henri Bénard, and Ch. Gagneux find that during pregnancy the leucocytes react in a specific way to placental extract. A study of the leuco-reactions makes it possible to determine the stage of pregnancy. There is also a placental reaction in the new-born (but not after a few days) and in sexually mature males.

Influence of Male Parent in Heredity.§—Gustave Loisel has experimented for five years on rabbits (288), carefully measuring all the organs in each generation. His general conclusion is that the male parent not only determines the characters of a proportion of the progeny, but modifies, in a degree which seems to be measurable, the hereditary transmission of the recessive characters of the grandparents.

Use of Selection Index Numbers in Breeding.||—Raymond Pearl and Frank M. Surface call attention to the usefulness of "selection index numbers" in breeding operations. The idea of such index numbers is to combine in a single numerical expression the values of a series of variable characters with regard to all of which the breeder wishes to practise selection at the same time. The analytical expression of this idea is discussed, and its adaptability and usefulness are illustrated by examples drawn from poultry and maize breeding. It is shown that selection index numbers form a valuable adjunct to the score card in stock judging.

* Arch. Sci. Phys. Nat., xxviii. (1909) pp. 499-500.

† Proc. Roy. Soc. Edinburgh, xxx. (1910) pp. 230-41 (2 pls.).

‡ C.R. Soc. Biol. Paris., lxxviii. (1910) pp. 159-61 (1 fig.).

§ Tom. cit., pp. 153-6.

|| Amer. Nat., xliii. (1909) pp. 385-400 (1 fig.).

b. **Histology.**

Mammalian Red Blood Corpuscles.*—E. Retterer and A. Lelièvre find that the first-formed red blood corpuscles are large nucleated cells. They disintegrate rapidly, their fragments circulate in the blood, and their liberated nucleus degenerates. The definitive non-nucleated red blood corpuscles are formed from the nuclei of somewhat older embryonic cells. This nucleus is transformed within the connective-tissue into a small mass with hæmoglobin, and the shape may be spherical, hemispherical, oval, or lenticular. The first-formed are cells, the others are transformed nuclei, and the first set does not give origin to the second set.

Integument of *Voeltzkowia mira*.†—W. J. Schmidt has made a thorough study of the general and minute structure of the skin in this lizard, discussing scales and scutes, epidermic sense-organs, pigment, peripheral nerves, and the development of the integument in the regenerated tail.

Nerve-Endings in Frog's Skin.‡—R. Hulanicka describes (1) two kinds of free nerve-endings in the frog's skin; (2) the diffuse occurrence of tactile cells; and (3) the innervation of the tactile prominences (Tastflecken of Merkel).

Cartilage of Regenerated Amphibian Extremities.§—K. Glaeser finds that parts of the persisting tissue change into fresh cartilage, and the greater part of the new skeleton is formed by a recapitulation of the ontogenetic process in a cartilaginous strand. There is no production of cartilage from similar tissue.

In newts a protochondral acidophilous substance arises from periosteum-fibrils and connective-tissue fibrils (axial regeneration). A basophilous cartilage, rich in cells, arises from the cells of the periosteum (peripheral regeneration). A basophilous cartilage, rich in cells, arises from fresh embryonic regeneration-tissue as in ordinary development (embryonic regeneration). Cartilage may also arise from the medulla of the bone.

The embryonic regeneration is independent of the place of amputation. Axial regeneration occurs after amputation of a small part of the extremity. Peripheral regeneration occurs after amputation of a large part of the extremity.

Structure of Heart Muscle.—K. W. Zimmermann,|| Irene von Palczewska,¶ and Marie Werner,** bring forward evidence, from a study of the heart in Man and Mammals, in support of the old view that the musculature consists of well-defined cells, in opposition to M. Heidenhain's view that the musculature in the adult heart is a reticulate syncytium with scattered nuclei.

* C.R. Soc. Biol. Paris, lxxviii. (1910) pp. 32-5.

† Zeitschr. wiss. Zool., xciv. (1910) pp. 605-720 (3 pls. and 24 figs.).

‡ Bull. Internat. Acad. Sci. Cracovie, 1909, pp. 687-9 (1 pl.).

§ Arch. Mikr. Anat., lxxv. (1910) pp. 1-39 (1 pl. and 16 figs.).

|| Tom. cit., p. 40.

¶ Tom. cit., pp. 41-100 (18 figs.).

** Tom. cit., pp. 101-48 (53 figs.).

Structure of Embryonic Supporting Tissue and Origin of Connective-tissue Fibrils.*—F. Meves has studied the chondriosomes which he finds in all the cells of the supporting tissue of the embryo, and he brings forward evidence that they form the material for connective-tissue fibrils. He describes the development of tendons, and shows that the fibrils, after they are once formed, increase independently both in length and thickness.

c. General.

Relation between Ciliary and Muscular Movements.†—A. G. Mayer has found that in Scyphomedusæ the nervous stimulus which produces each pulsation is caused by the constant formation of a uric oxalate of sodium in the marginal sense-clubs. This sodium oxalate precipitates the calcium which constantly enters the sense-club from the surrounding sea-water, and forms crystals of calcium oxalate, while sodium chloride is set free. Thus the stimulus which produces pulsation is due to ionic sodium.

The sodium of the sea-water is in many cases (Annelids, barnacles, Ctenophores, medusæ) a strong neuro-muscular stimulant, while the magnesium, calcium and potassium are inhibitors, and exactly counter-balance the stimulating effect of the sodium, thus permitting weak internal stimuli to produce movements.

It is remarkable, however, that the effects of the ions, sodium, magnesium, potassium, and calcium, upon the movements of cilia of Infusoria, vertebrate spermatozoa, marine larvæ, and Ctenophores, is always the exact opposite of their effect on the neuro-muscular system. In ciliary movement the depressant effect of sodium is offset by the stimulating influence of magnesium, potassium, and calcium. A *Spirillum* living in fresh-water reacted as do the cilia of animals, and it is suggested that the ciliary movements of animals may have been taken over from motile plant-like ancestors and maintained unchanged, whereas their neuro-muscular movements have been developed later and are controlled by the ions of the blood salts in a manner the exact reverse of cilia.

Distribution of Chitin.‡—D. H. Wester discusses the occurrence of chitin in Arthropods (even in the mid-gut in some cases); in Molluscs (e.g. in cuttlefish jaws, snail's radula, some bivalve shells and siphons, as in *Mya*; operculum of *Buccinum*); in Chaetopods (setæ, tentacles, intestine of earthworm and Aphrodite); in Brachiopods (shell, stalk and bristles of *Lingula*); in cuticle of Bryozoa; in Hydroids; in the gemmules of a fresh-water sponge. There is no chitin in silk or in byssus. None was found in the egg-shells of Invertebrates. There is no evidence of chitin in Protozoa, Echinoderma, or Vertebrates.

Supplementary Function of Foot in Yellow Races.§—Lannelongue brings together a number of interesting cases among yellow races in

* Arch. Mikr. Anat., lxxv. (1910) pp. 149-208 (2 pls.).

† Proc. Soc. Exp. Biol. and Med., vii. (1909) pp. 19-20.

‡ Zool. Jahrb., xxviii. (1910) pp. 531-68 (1 pl. and 1 fig.).

§ Comptes Rendus, cl. (1910) pp. 503-7.

which the foot retains considerable prehensile powers, e.g. in rowing, or in lifting objects from the ground. Some can even catch mice with their feet.

Os Penis and Os Clitoris in Apes.*—Ulrich Gerhardt describes the os penis in *Hylobates leuciscus*, *Siamanga syndactylus*, *Simia satyrus*, *Troglodytes niger*, etc., and the os clitoris in orang and siamang.

Nails of Primates.†—Fanny Bruhns gives a detailed account of the structure and disposition of the nails in lemurs and monkeys, with special reference to the phylogeny of the nails in man.

Restoration of Ancient British Race of Horses.‡—J. Cossar Ewart has tried by crossing ponies of different breeds, e.g. Connemara, Shetland, and Arab, to reconstruct or re-create the Celtic pony of pre-historic times. Of some forty crosses eventually produced, some belong to the robust "forest" type, some are a blend of the "forest" and "plateau" types, in others there is a suggestion of the Prjevalsky ("steppe") type, while several in their limbs, teeth, and skull, closely agree with the 12·2 bands pony found at the Roman fort of Newstead. The results strongly suggest that the ponies of north-western Europe are mainly a blend of a coarse-limbed, broad-browed, short-faced race of the "elephant bed" or Solutré type, and a fine-limbed race characterised by a fine muzzle and short-pillared molars, a race (like asses and zebras) without hind chestnuts and (unlike asses and zebras and the wild horse of Mongolia) without fetlock callosities or ergots.

Asymmetry of Cetacean Skull.§—Frederick Houssay expounds an ingenious theory, similar to one of Kükenthal's, as to the origin of the asymmetry in the Cetacean skull. The primitive Cetacean is supposed to have had a tendency to roll round on its own axis: the flippers counteract this: the result is dissymmetrical pressure on the head, and this brings about a deformation of the skull. This general idea is developed in detail. Direct adaptation appears to be postulated.

Macroscelidæ.||—Albertina Carlsson discusses the characters and position of these interesting Insectivores, contrasting the three genera—*Rhynchocyon*, *Petrodromus*, and *Macroscelides*. The affinities are closest with the Erinaceidæ, from the old stock of which the Macroscelids have probably arisen, but there are also marked affinities with the Tupaiidæ. A very instructive tabular contrast of the three families is given.

Significance of Milk Dentition.¶—W. Leche discusses the very interesting dentition of the badger and of *Proteles*, and finds additional evidence that the milk dentition represents a phylogenetically older state of affairs, being less differentiated than the permanent dentition, and without some of its specialised adaptations.

* Anat. Anzeig., xxxv. (1909) pp. 353-8 (6 figs.).

† Morphol. Jahrb., xl. (1910) pp. 501-609 (131 figs.).

‡ Proc. Roy. Soc. Edinburgh, xxx. (1910) pp. 291-311 (27 figs.).

§ Anat. Anzeig., xxvi. (1910) pp. 12-17 (1 fig.).

|| Zool. Jahrb., xxviii. (1909) pp. 349-400 (11 figs.).

¶ Tom. cit., pp. 449-56 (1 pl.).

Birds of Illinois and Wisconsin.*—Charles B. Cory has published an illustrated key to the 398 known birds of Illinois and Wisconsin, with descriptions of their various plumages, nests and eggs, and geographical distribution.

Reptiles of Mexiana.†—G. Hagemann gives an interesting account of the reptiles of this alluvial island in the Amazon estuary, which stands only a few feet out of the water, and is completely flooded every March. He discusses, among others, the beautiful tree-snake *Trypanurgos compressus*, the anaconda *Eunectes murinus*, the large turtle *Podocnemis expansa*, the caimans *Caiman sclerops* and *C. niger*. There are many interesting details given with regard to habits, e.g. the diet of snails in the case of *Dipsas bucephala* and other Amblycephalidæ, as also of *Dracæna guianensis*, which Goeldi regarded as a fish-eater. There is an extraordinary photograph showing the abundance of caimans in their "summer residence."

Habits of American Toad.‡—Newton Miller gives the following summary of his study of *Bufo lentiginosus americanus* Leconte.

Bufo lentiginosus americanus spawns from the latter part of April to the first of July. This species lays in small ponds, and only a portion of each is used as a spawning ground. The males are the first to reach the water in the spring; 88.8 p.c. of all the toads in a pond at any given time are males; males are in proportion to females as 80.7:100. Trilling in full vigorous voice is heard only during the mating season. Females respond to the call of the males. Males will not hold other males. Spawn may be deposited at a depth of 18 in. or more. This depth does not materially affect the hatching. Fertilisation takes place in an improvised basket formed by the hind feet of the male and the body and hind legs of the female. About 85 p.c. of the eggs laid in natural ponds are fertile. Oviposition requires 6 to 18 hours. The laying of two or four strands of eggs at a time cannot be considered of specific importance. Toads lay 3,900 to 15,800 eggs at one laying. The eggs hatch in 2 to 6 days, depending upon the temperature. Metamorphosis takes place in 32 to 200 days. On an average, the tadpoles double their weight seven times in 32 days. The tadpoles are omnivorous. Toads feed entirely on animal matter; no food is taken unless it shows signs of life. Toads refuse no insects, worms, or slugs which they can swallow. On an average, toads feed only once in a day and a half. The average amount eaten in a day by a toad is 1.12 gm. About 80 p.c. of the toad's food consists of harmful insects. Toads may be active from the latter part of March to the middle of November. Toads are chiefly nocturnal. Toads go into the ground to pass the winter. The greater percentage of those that do not get below the frost-line perish. In the strictest sense of the term, toads do not hibernate if kept in a warm place. Toads feed throughout the winter if kept warm, although eating comparatively little. No preparation is made for the winter other than burying to a depth below the frost-line. Some toads do not hibernate

* Field Mus. Nat. Hist. Chicago, ix. (1909) Publication 131, 764 pp. (many figs.).
 † Zool. Jahrb., xxviii. (1909) pp. 473-504 (1 pl.).

‡ Amer. Nat., xliii. (1909) pp. 730-45.

until after the middle of November. The eggs are seldom eaten by other animals. Great numbers of tadpoles are destroyed by insects and insect larvæ. Birds, fishes, and reptiles feed upon tadpoles. A large percentage of the eggs and larvæ are killed by the lowering of the water. Toads are destroyed, chiefly, by all classes of Vertebrates, by drought and winter, and by the sewer systems of towns.

Transformation of Palatal Region in Axolotl.*—P. Wintrebert finds that the larval vomer and palatine disappear during the metamorphosis. They undergo progressive decalcification. The so-called pterygoid bone, the "queue pterygoidienne" of the palatine, does not exhibit more than a partial involution. There is an autonomous formation of a new vomer, in which the palatine does not share. A new perichondrial ossification around the cartilaginous pterygoid is added to the partially retrogressive ossified part mentioned above.

Palatine and Pterygoid in Axolotl.†—P. Wintrebert finds that in a normal axolotl these two bones form one piece. An axolotl in bad condition absorbs more or less of its vomerine-palatal-ptyerygoid apparatus according to its degree of emaciation. A branchiate "Amblystoma" shows no palatine, a pterygoid as in the adult, and a well-ossified but incomplete vomer.

Rostral Teeth of Pristis.‡—H. Engel finds that these teeth are in structure and development allied to placoid scales. There is an epidermic enamel organ and a mesodermic tooth-germ. The primordium sinks into the mesoderm. There is pulp and a vascular reticulum in the young stages and the blood-vessels persist. The superficial layers of the point are vitrodentine and dentine. These are soon worn off and vasodentine is left. There is no replacement.

Suctorial Disc of Echeneis.§—Reinhard Honey gives an account of this extraordinary structure, discussing its musculature and sensory apparatus, and its innervation from the first five spinal nerves and a branch of the vagus. He goes into the evidence, showing that the organ has not arisen in its present position, but has passed from the trunk on to the head, apparently as a transformation of the anterior dorsal fin.

Notes from Millport Biological Station.||—R. Elmhirst notes that the hermit-crab which is usually associated with the sponge *Suberites domuncula* is *Eupagurus pubescens* (Kroyer), just as *E. prideauxii* is always found associated with the cloaklet anemone *Adamsia palliata*. But in three cases out of several thousands *E. bernhardus* was found with the sponge. Elmhirst has also some notes on the moulting and regeneration of *Galathea strigosa*, and on the lobster's aquarium habit of heaping up pebbles. He cites a case of a lobster burying its cast cuticle. The "spout-fish" (*Solen*) withdraws suddenly into its hole.

* C.R. Soc. Biol. Paris, lxviii. (1910) pp. 178-80. † Tom. cit., pp. 419-20.

‡ Zool. Jahrb., xxix. (1909) pp. 51-100 (4 pls. and 2 figs.).

§ Tom. cit., pp. 101-38 (4 pls. and 1 fig.).

|| Zoologist (Feb. 1910) 3 pp.

This is due in part to the expansion of the end of the foot into a disc like a mushroom-anchor, about two inches in diameter, and upturned edges. "Even a soft, fleshy mushroom anchor pressing into the sand would give an enormous hold." The spawn of *Oscanius* (*Pleurobranchus*) *membranaceus* is a soft gelatinous ribbon, about one inch thick and several feet long in an irregular coil. A spiral thread, containing the egg-capsules, runs through the ribbon. There seems to be one egg in each capsule; the diameter of an egg is about 0.1 mm. and that of a capsule 0.16 mm.

Period of Sexual Maturity in Marine Animals.*—Salvatore Lo Bianco supplements his previous collection of data (1888 and 1899) on the time of year at which the various animals in the Bay of Naples reach sexual maturity. His very valuable memoir refers to a large number of types, from Sponges to Fishes.

Former Land Bridge between Northern Europe and North America.†—R. F. Scharff states some of the evidences of this—partly geological, partly bathymetrical, partly distributional. Thus there are some animals which occur in Europe and North America, but not in Asia, such as the fresh-water sponges *Ephydatia crateriformis*, *Heteromeyenia ryderi*, *Tubella pennsylvanica*; the beetles *Carabus catenulatus*, *C. nemoralis*, *C. grænlandicus* and *C. chamissoni*; and a number of Collembola. Twelve species of Lepidoptera common to Europe and North America are absent from Asia, and the family of Percidæ are absent from Western North America and Eastern Asia. The distribution of *Helix hortensis* is interesting, for it occurs in Great Britain, Ireland, Greenland, and some localities in North America.

Tunicata.

Antarctic Tunicata.‡—W. A. Herdman reports on a collection of about twenty-two species from the sea area south of 60° S. Two species of *Styela*, one of *Halocynthia*, one of *Boltenia*, four of Molgulidæ and two compound Ascidiæ are new to science. The collection confirms the view which Professor Herdman has previously expressed, that the Ascidian fauna of the far South is characterised by the abundance and the large size of the individuals of a comparatively small number of species. In the present collection, made by the 'Discovery,' there are specimens of *Styela spectabilis* 18 cm. in length, of *Molgula holysoni* of 4 cm., of *Halocynthia setosa* of 10 cm., and so on.

INVERTEBRATA.

Mollusca.

a. Cephalopoda.

So-called Olfactory Organ in Cephalopods.§—Grace B. Watkinson has studied the olfactory organs in *Sepia*, *Loligo*, *Octopus*, and other forms.

* MT. Zool. Stat. Neapel, xix. (1909) pp. 513-761.

† Proc. R. Irish Acad., xxviii. (1909) No. 1, pp. 1-23 (1 fig. and 3 maps).

‡ National Antarctic Expedition, Nat. Hist., v. (1910) pp. 1-26 (7 pls.).

§ Jen. Zeitschr. f. Natur., xlv. (1909) pp. 353-414 (2 pls. and 47 figs.).

There are two types, papilla-like and pocket-like, with transitions. The pocket type is often changed in form by the contraction of the skin, and may be protruded.

The organ consists of a layer of thickened epithelium with nerve-endings. The olfactory epithelium consists of ciliated cells and sensory cells, the latter being deeply situated, probably amœboid, with a peculiar slightly pigmented body inside and a rounded or rod-like terminal process.

The "olfactory nerve" does not arise from the ganglion pedunculi ("olfactory ganglion"). Its fibres run in close association with the optic nerve, and are probably not exclusively of cerebral origin. The "olfactory organ" of Dibranchiata is in its innervation homologous with the rhinophores of *Nautilus*, but not with the osphradia of other molluscs. It is probably an organ of chemical sense for testing the water.

γ. Gastropoda.

Abnormalities in Genital Ducts of *Helix pomatia*.* — Gustav Polnszyński describes some variations, e.g. in the presence of a short diverticulum on the duct of the receptaculum, a trace of its connection with the oviduct during development. In five cases the duct of the receptaculum divided into two for a short distance and then became one again. The duct of the receptaculum is phylogenetically the youngest part, and it shows considerable variability, notably of a reversionary sort.

Spermatogenesis in *Helix*.† — Max Kleinert gives a detailed account of the stages of spermatogenesis in *Helix (Tachea) nemoralis* and *hortensis*. The spermatogonia have forty-eight chromosomes, among which are two particularly large and bent or horse-shoe shaped. The two large chromosomes divide longitudinally; in the small chromosomes the direction of the division was not clear. Full particulars are given of the reduction to twenty-four chromosomes, of the idiozome or "Nebenkern," and of the differentiation of the spermatozoon. There is in the spermatogenesis no difference between the 5-banded and 3-banded forms of *Helix nemoralis*, or between the unbanded and banded forms of *Helix hortensis*.

Noises made by Snail on Window-pane.‡ — Fred Vlès discusses this problem, in regard to which there is considerable difference of opinion. His observations lead him to conclude that the grating noise is due to the shell, not to the radula, and that there is another rarer noise of unknown origin, like that made by the bursting of a large bubble on the surface of water.

δ. Lamellibranchiata.

Commensal Lamellibranchs.§ — Paul Pelseeneer discusses *Montacuta* found on *Echinocardium* and *Spatangus*, *Entovalva* Voeltzkow in the gullet of Synaptids, *Scioberetia* Bernard on a sea-urchin (*Tripylus*), and

* Bull. Internat. Acad. Sci. Cracovie, 1910, pp. 17-20.

† Jen. Zeitschr. f. Natur., xlv. (1909) pp. 445-98 (4 pls. and 22 figs.).

‡ Bull. Soc. Zool. France, xxxiv. (1910) pp. 251-4.

§ Bull. Acad. Roy. Belg., Classe des Sciences, 1909, No. 12, pp. 1144-50.

Jousseamiella Bourne on a Sipunculid (*Aspidosiphon*). They form a series of increasing specialisation—from *Montacuta* to *Eutovalva*, and further to *Jousseamiella* and *Scioberetia*—and their origin must be found among the Lucinacea. They are related to one another, and are rightly referred to a special family, Montacutidæ, for which the following diagnosis is proposed: Commensal Lucinacea, opisthogyrous; the mantle with one posterior suture considerably elongated; the foot byssogenous, and provided with an anterior protractor; the gill formed of one lamella; hermaphrodite, retaining the young in an incubatory chamber (probable in *Jousseamiella*).

New Bivalves from Falkland Islands.*—J. E. Cooper and H. B. Preston describe a number of new species, additions to the somewhat meagre Molluscan fauna, as at present known, of the Falkland Islands. Two small species, apparently referable to the family Erycinidæ, require new genera, which are named *Malvinasia* and *Davisia*.

Mussels Settling in Gas-vesicle of Seaweed.†—Tobler describes how the larvæ of *Mytilus edulis* pass into injured gas-vesicles of *Ascophyllum nodosum*, settle down there, begin their shell-development, and gradually outgrow the vesicle, in which they induce a series of interesting modifications.

Byssus-apparatus of Lamellibranchs.‡—E. Seydel has made a comparative study of the byssus-apparatus in Arcinæ, Pectinidæ, Limidæ, Aviculidæ, Anomiidæ, Mytilidæ, and Dreissensiidæ, discussing the musculature, the acidophilous glands (which form the byssus), the basophilous glands (which are quite accessory), the epithelium lining the apparatus, and so on. The byssus is not a simple but a composite secretion.

Arthropoda.

a. Insecta.

Seed-gathering Ants.§—F. W. Neger has studied the ways of *Messor barbarus*, a common ant in Dalmatia, which is at once a leaf-cutter and a seed-gatherer. Most of the seeds (of Leguminosæ in particular) had already begun to germinate when the ants put them out to dry, and it is suggested that the advantage of the germination is to burst the seed-coats, for it does not go far enough to change the starch into maltose and dextrin. The shelled and desiccated seeds are taken back to the nest and chewed into a dough, which is exposed in the sun in crumbs, and baked into biscuit-hardness. Perhaps there is some sterilisation in this, but there is some mould left (*Aspergillus niger* is abundant), which may act as a ferment on the starch.

Habits of *Cecophylla smaragdina*.||—E. Bugnion gives some account of this common ant of hot countries, which nests on trees and uses the

* Ann. Nat. Hist., v. (1910) pp. 110-14 (1 pl.).

† SB. Nat. Ver. Preuss. Rheinlande, 1909, pp. 10-12.

‡ Zool. Jahrb., xxvii. (1909) pp. 465-532 (7 pls. and 16 figs.).

§ Biol. Centralbl., xxx. (1910) pp. 133-50 (3 figs.).

|| Arch. Sci. Phys. Nat., xxviii. (1909) pp. 511-13 (3 figs.).

silk-secreting larva as the source of supply for the thread with which the leaves are bound together into a nest. Bugnion describes the extraordinary device employed in drawing two distant leaves together. Several ants, up to five or six, form a chain to bridge the gap, one ant gripping the waist of another in its mandibles. Many such chains may co-operate for hours in drawing two leaves together.

Ants' Nests.*—A. Forel, in a report on ants from Barbary and from Ceylon, gives an account of the different kinds of nests made by various species of *Polyrhachis*:—A. Nests of pure silk: (1) a multilocular labyrinth of pure silk; (2) a unilocular web on a leaf; (3) a fine silken tissue lining a unilocular subterranean chamber. B. Nests of silk and debris, of two types. C. Nests of silk and paper, of two types. D. Some doubtful types.

Regeneration in Insects.†—Viktor Janda has made some remarkable experiments. The larvæ of *Aeschna* are able to re-grow excised antennæ, legs and wing-rudiments. The regeneration goes on slowly in the interval between two moults, beneath the old cuticle, without being externally noticeable. Total extirpation of antennæ and limbs is followed by their restitution. The size of the regenerated part is proportional to the time between the operation and the next moult.

The regenerative capacity in nymphs of *Libellula* is much less than in Aeschnids, but in favourable conditions antennæ and limbs may be re-grown. As Child and Young found, the limbs of Agrionid larvæ have a high regenerative capacity, and the regenerated tarsi have fewer joints than the normal.

Thoracic Glands in Caterpillars.‡—L. Bordas describes, in illustration of these glands, that found in the caterpillar of *Stauropus fagi*. It is 6-7 mm. in length, with delicate walls, between the nerve-cord below and the mid-gut above. It extends posteriorly into the abdomen, and narrows anteriorly, without a distinct duct, to open between the first pair of limbs on the first thoracic segment. Bordas also refers briefly to the similar gland in *Hadena monoglypha*.

Development of Eggs of Silk-moth.§—C. Vaney and A. Conte distinguish three periods in the development of the "univoltin" egg: (1) the period of the formation of the germinative "bandelette" and the vitelline elements (about five days); (2) the period of latent life without appreciable embryonic changes (nine months); and (3) the period of embryonic construction, in the course of which (about ten days) a caterpillar is formed. In the first period there is a percentage loss of weight of 2.67, in the second of 4.96, in the third of 7.84. The authors have also studied the changes in the content of glycogen and fat. During histogenesis there is a great consumption of glycogen. A contrast is drawn between the development of the "univoltin" and the "polyvoltin" eggs of silk-moths.

* Bull. Soc. Vaud. Sci. Nat., (1909) pp. 369-407.

† SB. k. Böhm. Ges. Wiss., xxi. (1909) pp. 1-36 (2 pls.).

‡ Bull. Soc. Zool. France, xxxiv. (1910) pp. 248-9.

§ Comptes Rendus, cl. (1910) pp. 553-5.

Assimilation of Carbon Dioxide by Pupæ.*—Marie von Linden brings forward fresh evidence in support of her conclusion that pupæ, e.g. of *Hylophila prasinana*, are able to assimilate carbon dioxide from the air.

Malpighian Tubes in Larval Lepidoptera.†—L. Bordas finds that the number of these in caterpillars is six, except in *Carpocapsa pomonella*, where there are four. They are usually varicose. Their wall consists of an external peritoneal membrane, a basilar membrane, and a secretory epithelium. The urinary reservoir has almost the same structure. The tubes contain crystals of uric acid, urates of sodium and ammonium, oxalate of lime, and, especially, crystalline concretions of carbonate of lime.

Histology of Metamorphosis.‡—Ch. Pérez distinguishes three general processes. 1. There is total atrophy and destruction of the most highly specialised organs of the larva. Except in the case of the epithelium of the mid-gut, which is exuviated, the mechanism of the atrophy is by phagocytosis. 2. The most highly specialised organs of the imago are constructed de novo from special embryonic histoblasts. 3. Some structures are gradually altered in situ, passing over from larva to imago after modification. There is a “de-differentiation” and a “re-differentiation,” sometimes associated with a curious cellular purgation. In Muscids there is an almost complete destruction and re-construction, but in many other types there is more of the third mode of transformation.

Metamorphosis of Malpighian Tubes in Muscids.§—Ch. Pérez finds that the four Malpighian tubes of the Muscid larvæ persist to form those of the adult, whereas in some other cases, e.g. ants, they disappear and are formed de novo. But it is interesting to observe that during the pupa period the Malpighian tubes exhibit a progressive loss of their larval differentiation. They cease for a period to be excretory, and are stores of fatty material. Gradually re-differentiation sets in.

Living Species of Diplonema.||—Nelson Annandale gives a diagnosis of a surviving species of this genus of Psychodid Diptera. Three specimens were captured in the Darjeeling district (altitude 5000 ft.). The genus *Diplonema* appears to have been known hitherto from three Tertiary species, which occur in Baltic amber, and from one quaternary form in fossil copal.

Empididæ.¶—M. Bezzi reports on a rich collection of these Dipterous insects made by W. Schnuse in South America, describing no fewer than ninety species. Many of these are new, and six new genera are established.

Alimentary Tract and Habits of Simulium columbacensis.** Jivoïn Georgevitch discusses this “Goloubatz” fly, which destroys numerous pigs, horses, and cattle in Servia. There is a suctorial pump

* SB. Nat. Ver. Preuss. Rheinlande, 1909, pp. 25-30.

† Comptes Rendus, cl. (1910) pp. 737-9.

‡ C.R. Soc. Biol. Paris, lxxviii. (1910) pp. 167-8. § Tom. cit., pp. 42-3.

|| Journ. Proc. Asiatic Soc. Bengal, iv. (1908, received 1910) pp. 353-4.

¶ Abhandl. k. Leopold. Carol. Akad. Nat., xci. (1909) pp. 293-408 (1 pl.).

** C.R. Soc. Biol. Paris, lxxvii. (1909) pp. 540-2 (1 fig.).

in the middle of the œsophagus—an unusual position. The wound is made in the same way as in the mosquito. A trypanosome, *Crithidia simuliæ*, was found in the intestine.

Rat Fleas at Marseilles.*—J. Const. Gauthier and A. Raybaud give statistics of the different kinds of fleas found on the brown rat (*Mus decumanus*), the black rat (*Mus rattus*), and the Alexandrine variety (*Mus alexandrinus*). The commonest is *Pulex cheopis*, the others are *Ceratophyllus fasciatus*, *Ctenopsylla musculi* and *Ctenocephalus serraticeps*. The human *Pulex irritans* was not found. The seasonal distribution is of interest. The months of August and September show the greatest prevalence of *P. cheopis* (on the brown rat), and these are the months in which there is most plague in temperate parts of the northern hemisphere.

Rat Flea capable of Biting Man.†—J. Const. Gauthier and A. Raybaud have put it beyond doubt that *Ceratophyllus fasciatus*, the habitual flea of the rat (*Mus decumanus*), is able to “bite” man, and thus to play a role in distributing plague and other diseases.

New Species of Rhipidius.‡—Abeille de Perrin has some notes on *Rhipidius boissyi* sp. n. from Provence, one of those strange and very rare little beetles which spend their larval life inside Orthoptera, as *Stylops* in Hymenoptera.

External Digestion in Carabus auratus.§—Hermann Jordan has observed how this beetle makes a depression in a piece of flesh that it is eating, exudes some digestive juice into this, works it up with its jaws, and goes on doing so until a genuine external digestion has occurred. The author has collected a number of other instances of this external digestion of the food.

Eyes of Pentamerous Beetles.||—Otto Kirchner has made a detailed study of the eyes of Staphylinidæ, Histeridæ, Silphidæ, Cleridæ, Elateridæ, etc. He finds that they have no crystalline cones. An apparent crystalline cone seen in many cases is merely a piece of the cornea. The retinula consists of eight visual cells, with seven distal nuclei, and one sunk deeply. The rhabdom is usually formed from only six of these visual cells. The cell whose nucleus is deeply sunk is in many cases the origin of a basal rhabdom, or basal organ. But we cannot do more than refer to a few of the conclusions of a very careful piece of work.

Reactions of Mealworms.¶—Max Morse has investigated the factors determining the reactions of the larva of *Tenebrio molitor*. The body surface as a whole is sensitive to light of great intensity. Nevertheless there is no orientation exhibited by virtue of this reaction. This was made evident by painting one side of the animal with lampblack mixture, leaving the head exposed. Orientation takes place by means of

* C.R. Soc. Biol. Paris, lxxviii. (1910) pp. 196-9.

† Op. cit., lxxvii. (1909) pp. 859-60.

‡ Tom. cit., pp. 854-8.

§ Biol. Centralbl., xxx. (1910) pp. 85-96.

|| Arch. Biontolog., ii. (1909) pp. 237-87 (7 pls.).

¶ Journ. Comp. Neurol. and Psychol., xix. (1909) pp. 721-9 (1 fig.).

the light receptors entirely—the eye-spots which lie on either side of the head, immediately posterior to the base of the antennæ. The larvæ are positively geotropic. The mealworm's random movements are discussed, and it is shown that the tropism theory, at least in its naive form, cannot be made to apply to its behaviour. Low in the scale as it is, the larva presents highly complex behaviour, the factors of which are but slightly known.

Development of *Agelastica alni*.*—Benedykt Fulinski finds that the so-called blastoderm is developed quite in the same way as in other Chrysomelidæ, but the ventral portion of the blastodermic epithelium—the germinal ectoderm—forms two lateral plates and a median plate, which are not sharply marked off from one another. The amnion-folds develop from the germinal ectoderm, and the amnion-cavity precedes gastrulation. In gastrulation there is a true invagination, the middle plate being inturned into the yolk and forming the primary endoderm, which subsequently differentiates into the secondary endoderm and the mesoderm.

Effect of Centrifugal Force upon Eggs of Chrysomelid Beetles.† R. W. Hegner has made some interesting experiments yielding the following results. 1. Eggs of Chrysomelid beetles, when oriented in a centrifugal machine, with either posterior or anterior ends toward the axis of rotation, and subjected to 1500–2000 revolutions per minute for from 1 to 12 hours, become stratified into three layers: (*a*) a light vesicular zone at the inner end, (*b*) a heavy granular grey cap at the outer end, and (*c*) a comparatively large intermediate mass of yolk, the larger globules lying at the outer end of this layer. 2. The grey cap is induced by a lesser amount of centrifugal force in an egg containing many cleavage nuclei than in a fresh egg. Either the grey-cap material is liberated during development, or else some condition of the yolk-mass in the older egg allows it to pass more rapidly toward the heavier end. The grey-cap material is not necessary for the normal development of the embryo. 3. The vesicular zone becomes visible after 15 minutes of centrifuging. It is composed of fat imbedded in cytoplasm. This zone disappears during development. 4. The yolk-globules are distributed throughout the intermediate region of the egg; the largest spheres are at the outer heavy end. It takes very little centrifugal force to cause this rearrangement. Restitution to the normal condition takes place soon after the egg is removed from the centrifugal machine. 5. The cytoplasm is lighter than the grey-cap material or the yolk, but heavier than the fat of the vesicular zone. The passage of the cytoplasm to the light end of the egg does not incapacitate it for the production of an embryo. 6. The nuclei are apparently equal in specific gravity to the cytoplasm. Cleavage nuclei and vitellophags rise to the inner end of the egg; the nuclei of the blastoderm of older eggs are not visibly influenced by centrifugal force. 7. The germ-cell determinations move en masse from their usual position at the posterior end towards the anterior end when the former is placed inward. The further history of these granules has not been

* Bull. Internat. Acad. Sci. Cracovie, 1910, pp. 12–16.

† Journ. Exper. Zool., vi. (1909) pp. 507–52 (24 figs.).

traced. 8. Restitution takes place very slowly. Those substances easily displaced are also the first to redistribute themselves. The cytoplasm seldom regains its normal position, but produces a dwarf embryo outside of the yolk at the light end of the egg. 9. The age of the egg determines the susceptibility to centrifugal force and the future growth of the embryo. In general, an egg in a late cleavage stage becomes stratified sooner than a fresh egg. Eggs centrifuged when in the blastoderm stage or older almost always produce normal embryos, and sometimes larvæ. 10. Centrifugal force has no influence upon the rate of development of eggs which produce normal embryos or larvæ. 11. The orientation of the embryos produced by centrifuged eggs is not affected by centrifugal force. Dwarf embryos, however, are frequently formed at the posterior ends of the eggs: these never produce larvæ. 12. In the majority of cases the eggs laid by centrifuged beetles produce normal larvæ. 13. The eggs of insects, although supposed by many embryologists to be the most highly organised of any animal eggs, may have their contents profoundly disturbed without preventing the production of a normal embryo. The cytoplasm and nuclei of centrifuged eggs are forced out of their usual positions, but often normal development takes place. This would indicate that a high degree of organisation does not prevent the egg from adapting itself to changed conditions.

Minute Structure of Gut in *Chrysopa perla*.*—James McDunnough gives a detailed histological account of the structure of the gut and its associated organs (Malpighian tubules, salivary glands, etc.), both in the larva and in the imago of *Chrysopa perla*. We shall do no more than quote one of his conclusions. "The epithelium of the mesenteron is formed of homomorphic cells, which have alternately the functions of secretion and of absorption; the 'Stäbchensaum' is no permanent structure, but appears mainly on resting cells; the peritrophic membrane is to be regarded as a product of the whole mid-gut epithelium, and has nothing in common with the intima of the stomodæum."

Genital Apparatus of Neuroptera.†—H. Stitz gives a careful account of this in *Sialis lutaria*, *Rhaphidia notata*, *Chrysopa perla*, *C. vulgaris*, *Hemerobius nervosus*, and *Myrmeleon*. The males always show paired testes, an ejaculatory duct, and a copulatory organ—the two last relatively simple. The vesicula seminalis may be very complicated. In *Sialis* the female parts are paired almost to the aperture, even the bursa copulatrix being divided. The author discusses the various forms of bursa, receptaculum, vestibulum, and so on. Characteristic structures are the "rosettes" on the anal valves of both sexes.

Revision of Order Strepsiptera.‡—W. Dwight Pierce has done good service in preparing a revision of this interesting order, which he regards as quite by itself, on a distinct line from that of Coleoptera and nearer the Hymenoptera and Diptera, and as highly specialised as the highest insects in any of the orders. He discusses the remarkable life-history,

* Arch. Natur., lxxv. (1909) pp. 313-60 (5 pls.).

† Zool. Jahrb., xxvii. (1909) pp. 377-448 (5 pls. and 26 figs.).

‡ U.S. Nat. Mus., Bull. 66 (1909) pp. 1-232 (15 pls.).

the effect of the parasitism on the host, the sexual dimorphism and the internal structure, and takes a systematic survey of all the known forms.

New Strepsipteron.*—K. Hofeneder describes *Mengenilla chobartii* g. et sp. n., from North Africa, a Strepsipteron allied to *Mengea* from Baltic amber, notably in having a 5-jointed clawed tarsus. The 6-jointed antennæ have joints 3 to 5 prolonged into lateral processes.

New Species of Fossil Cockroach.†—H. Bolton describes an Orthopteron wing from the South Wales coal-field, and refers it to *Archimylaeris* (*Etblattina*) *woodwardi* sp. n.

β. Myriopoda.

New Millipedes.‡—F. Silvestri describes a number of new forms from Uganda, establishing the following new genera: *Eviulisoma*, *Rhapidostreptus*, *Analocostreptus* and *Metriostreptus*. He also gives § preliminary descriptions of ten new genera of Diplopoda from Mexico, South America, and other countries.

Structure of Polydesmus.||—W. Effenberger has done a useful piece of work in giving a clear account of *Polydesmus complanatus*—especially of its external characters, respiratory system, alimentary tracts, glands, and reproductive organs. He also discusses this millipede's habits.

δ. Arachnida.

Fragmenta Arachnologica.¶—Vl. Kulczynski describes some new Mediterranean species of *Palpimanus*, and submits additions to or corrections of previous descriptions of various species of *Araneus*, *Xysticus*, and *Lycosa*.

New Cteniform Spiders from South America.**—Embrik Strand reports on a number of interesting forms with a general resemblance (in the disposition of their eyes) to the genus *Ctenus*, e.g. new species of *Acanthoctenus*, *Ctenus*, *Enoploctenus*, *Cupiennius*.

Development and Origin of Respiratory Organs in Araneæ.††—W. F. Purcell has studied the development of the lung-books, of the tracheæ, of the abdominal longitudinal muscles and their tendons, of the entapophyses (ectodermal tendons) of the pulmonary segment, and other associated structures. Forty-one species of spiders were used for anatomical purposes. The development was studied chiefly in *Sitticus* (*Attus*) *floricola* C.K. We shall state some of his general conclusions.

The medial trunks of the tracheæ must be regarded as equivalent in their entirety to metamorphosed entapophyses.

The pair of lateral branches of the tracheæ of the ninth somite in

* Ber. Nat. Med. Ver. Innsbruck, xxxi. (1910) pp. 33-53 (1 pl.).

† Geol. Mag., vii. (1910) pp. 147-51 (1 pl.).

‡ Ann. Mus. Civico Storia Nat. Genova, iv. (1910) pp. 457-78 (9 figs.).

§ Zool. Anzeig., xxxv. (1910) pp. 357-64 (10 figs.).

|| Jen. Zeitschr. Natur., xlv. (1909) pp. 527-86 (4 pls. and 13 figs.).

¶ Bull. Internat. Acad. Sci. Cracovie, 1909, pp. 667-87 (1 pl.).

** Zool. Jahrb., xxviii. (1909) pp. 401-28.

†† Quart. Journ. Micr. Sci., liv. (1909) pp. 1-110 (7 pls. and 7 figs.).

Dipneumonous spiders must have been derived from the pulmonary sac, and not the reverse.

The secondary tracheal tubes may arise anywhere on a tracheal trunk, when required, and quite independently of the pulmonary saccules.

The arguments in favour of the branchial origin of the lung-saccules (from sunken-in gill-lamellæ) appears overwhelming. The lung-books of scorpions and spiders have arisen independently.

Tracheæ in Araneæ have a diphyletic origin, from entapophyses and from lung-saccules. There is no evidence of any sort to indicate that the spinnerets of spiders were derived from sunken-in lung-books.

Phylogeny of Tracheæ in Araneæ.*—W. F. Purcell suggests that the saccules (hollow air-containing leaves) of the second pair of lung-books have been converted into tracheal tubules in the common ancestor of the Dysderidæ, Oonopidæ, and Caponiidæ. The resulting tracheæ then increased in size, and, as the number of the leaves of the anterior lung-books decreased in inverse ratio, the former became the principal organs of respiration.

The second pair of spiracles retained their position, or may even have moved slightly forwards, and the conversion of the entapophyses into tracheæ could not take place here, and would, moreover, be quite unnecessary.

In the Caponiidæ the anterior pair of lung-books were converted into tracheæ in a similar manner, but at a later period, and independently of the conversion of the posterior pair; but as the latter already provided almost the entire body with tracheæ, the anterior pair did not further increase in size. In the second place, in the progenitor, or progenitors, of the remaining tracheate spiders, the posterior lung-books became reduced in size and effectiveness by the disappearance of their saccules, accompanied by an increase in the number of the leaves of the anterior lung-books. Further, the posterior spiracles became approximated and united to a single spiracle and moved towards the hinder end of the body, thereby causing the entapophyses of the tracheal segment to elongate. In this condition the Filistatidæ, Sicariidæ and Palpimanidæ have remained, with slight modifications, such as the division of the tracheal ante-chambers into branches in some forms.

In the great majority of the families, however, the elongated entapophyses became transformed into a pair of medial tracheal trunks, thus producing a tracheal system consisting of four simple unbranched trunks, which is still found in some genera at least, in nearly all the families.

A new factor having been introduced, viz. the presence of the respiratory entapophyses lying in the large ventral sinus containing venous blood requiring aeration, we accordingly find the second respiratory segment again taking a prominent part in the respiration in many forms, owing to the increase in size and the branching of the medial trunks, accompanied ultimately by a corresponding reduction in the size of the anterior lung-books, e.g. in the Attidæ. This method of origin of the tracheæ is independent of that of the Dysderidæ and their allies, and the tracheal tubules, when present, would here not be derived from saccules, but would be new formations.

* Quart. Journ. Micr. Sci., liv. (1910) pp. 519-64 (1 pl. and 21 figs.).

Development of Lung-books and Tracheæ in Spiders.*—Reinold Janeck has studied this, especially in *Lycosa amentata*, with some other forms for comparison. The foldings on the under surface of the primordium of the abdominal appendage are quite distinct from the foldings which give rise to the lung-book, and the author is against the view which derives lung-books from branchial organs.

The lung-book arises from a compact cell-mass, of ectodermic origin, and from an associated invagination of the ectoderm; the tracheæ arise from invaginations of ectoderm, and there is often a solid proliferation which subsequently gets a cavity. The author is therefore strongly in favour of the view which derives lung-books from tracheæ.

Spinnerets, Cribellum and Respiratory Organs of Spiders.†—Thomas H. Montgomery, jun., has studied *Theridium*, *Loxosceles*, *Eva-grus* and *Filistata*. He confirms the interpretation of the cribellum as a modified and fused pair of spinnerets. The colulus or hypopygium is an integumentary extension with a large axial blood cavity, and may be a supplementary respiratory organ. The anterior spinnerets and colulus or cribellum develop from the fourth abdominal segment, the median and posterior spinnerets from the fifth. The colulus and cribellum arise as elongate thickenings mesial from the appendages of these segments, the appendages becoming the anterior and posterior spinnerets. Colulus and cribellum are in their development homodynamous with the median spinnerets of the segment behind them.

Each lung-book arises in the region of the appendage of the second abdominal segment. An ectoblastic invagination forms the stigma and chamber, and into this the appendage invaginates, forming both operculum and secondary lamellæ. There are no radical anatomical differences between tracheæ and lung-books, but the developmental differences are considerable, and there is no complete homodynamy between the two sets of organs. There is no embryological ground for deriving the lung-books from gills.

Structure of *Ixodes reduvius*.‡—Erik Nordenskiöld continues his account of this tick, and describes the circulatory, respiratory, and reproductive systems.

6. Crustacea.

Sex-recognition in Crawfishes.§—A. S. Pearse has studied the copulating reactions of three species of *Cambarus*. Males which had recently been in active copulation were not necessarily induced to copulate again by the immediate presence of an active female. The readiness with which copulation takes place depends largely on the "chance" coming in contact of two individuals which are in the proper physiological state. The temperature of the water has some influence; conditions of light-stimulation are apparently of little consequence; experiments with pieces of ovary and the like lend no support to the view that there is any

* Jen. Zeitschr. f. Natur., xlv. (1909) pp. 587-646 (1 pl. and 67 figs.).

† Proc. Acad. Nat. Sci. Philadelphia, lxi. (1909) pp. 299-320 (4 pls.).

‡ Zool. Jahrb., xxvii. (1909) pp. 449-64 (1 pl.).

§ Amer. Nat., xliii. (1909) pp. 747-53.

stimulating secretion given off by the female. Sexual union seems more or less a matter of chance. There is little or no power of sex-discrimination. During the mating season the male "tries" every crawfish which he meets, and the instinct of the female is to remain passive, while another male seeks to escape.

Distribution of *Palinurus vulgaris* in British Waters.*—James Ritchie finds that the thorny lobster has been recorded from various localities along all the coasts of the British Isles, except from that portion of the east coast which lies to the north of Flamborough Head. It is most abundant in the south-west, becoming scarcer northwards, although the apparent scarcity may, in part, be due to its long and unyielding antennæ, which frequently hinder it from entering crab-pots.

Jurassic and Modern Eryonidæ.†—Walther von Knebel has given a precise diagnosis of the family Eryonidæ and a reconstruction of the Jurassic forms, even the moulting process being recorded in the fine stone. There seem to have been ancient attempts at establishing new adaptations on the part of the Jurassic Eryonids, but without achievement. In the section Eryonidæ angustiformes there is persistence of highly evolved features from the Jurassic times till now.

Variability of *Palæmonetes varians*.‡—Artur Brozek has made a statistical study of this common prawn at Trieste, and compares his results with those obtained at Plymouth and elsewhere.

Blind Prawn from Galilee.§—W. T. Calman describes *Typhlocaris galilea* g. et sp. n., from a small pond communicating with the Sea of Galilee. It probably came from subterranean waters. Though referable to the Palæmonidæ, it is quite different from *Palæmonetes antrorum* Benedict and *P. eigenmanni* Hay from Central Africa, and requires a new genus. The list of subterranean Decapods now includes nine forms, viz. two Atyidæ (*Troglocaris schmidti* Dorm. and *Palæmonias gauteri* Hay), four species of *Cambarus*, and the three forms referred to above.

Eyes of Gammarids.||—E. Strauss gives a careful description of the structure of the normal eye in Gammarids and of various stages of degeneration. The crystalline cones may become small discs, or may wholly disappear. The reticulæ and rhabdoms may be affected, and the point of this fine study is that stage after stage of degeneration is depicted in a succession of types, until finally even the optic nerves disappear.

Agglutination of Blood Corpuscles in Gammarus.¶—John Tait finds that the antennæ of *Gammarus marinus* afford a very convenient object for the study of the agglutination of the blood corpuscles. If the end is cut off the blood pours out into the surrounding water and the formation of the clot is very readily observed.

* Proc. Roy. Phys. Soc. Edinburgh, xxiii. (1910) pp. 68-71.

† Arch. f. Biontolog., ii. (1909) pp. 195-233 (4 pls.).

‡ SB. k. Böhm. Ges. Wiss., 1909, No. 2, pp. 1-11 (1 pl.).

§ Trans. Linn. Soc. Zool., xi. (1909) pp. 93-7 (1 pl.).

|| Wiss. Ergebnisse Deutsch. Tiefsee Exped., xx. Lief. 1, pp. 1-84 (6 pls. and 47 figs.).

¶ Quart. Journ. Exp. Physiol., i. (1903) pp. 247-9.

Studies on Isopods.*—K. W. Verhoeff establishes four new genera of Oniscinae, several new species of *Porcellio*, and a new genus of Trichoniscidae. He discusses some morphological points connected with the appendages. In referring to the stridulating apparatus in *Ligia* and *Syspastus*, he notes that he has had the pleasure of listening to the sounds made by *Armadillo officinalis*. This is made by both sexes when rolled up, and it is due to a kind of rotating movement of the fourth and fifth pairs of legs.

Crustaceans living in Ascidians.†—E. Chatton and E. Brément describe *Enterocola pterophora* sp. n., a sluggish eruciform Copepod living in *Leptoclinum commune*. It is readily distinguished from other species of the genus by the presence of aliform dorsal plates.

The authors also describe ‡ *Mycophilus curvatus* sp. n., another ascidicolous Copepod, from *Polycyclus renieri* and various species of *Botryllus*. It is pointed out that the genera *Mycophilus* and *Enteropsis* are very closely alike, and may simply be two stages in parasitic adaptation.

Crustacea in Gizzard of Deep-sea Cuttlefish.§—Thomas Scott reports on "a carcinological collection" obtained in the stomach of *Staurotenthes hippocrepium*, from a depth of 2425 fathoms. The most interesting item was *Pontostratiotes abyssicola* Brady, a curious species which does not seem to have been met with since Brady's discovery of it in the 'Challenger' collection. The author supplements Brady's description.

Wood-boring Crustacea from Christmas Island.||—W. T. Calman describes *Chelura insulæ* sp. n., and *Limnoria andreusi* sp. n. The aberrant Amphipod family Cheluridae has hitherto comprised only a single species, the well-known *Chelura terebrans* of the North Atlantic and adjoining seas, and the discovery of a second species in the Indian Ocean is therefore of interest. Of the Isopod genus *Limnoria* five species have been already described; of these the only one known from tropical seas (from the island of Minikoi) is *L. pfefferi* Stebbing; it appears to be very different from that now described from Christmas Island.

Fresh-water Lernæopodidæ.¶—E. Neresheimer discusses such forms as *Tracheliastes*, *Achtheres percarum*, *Basanistes huchonis*, *B. coregoni*, *Lernæopoda carpionis*, and *L. heintzi* sp. n., and shows that for the determination of genera and species reliance may be placed on the structure of the attaching apparatus of the second maxillipede.

Autumnal Iridescence of Lakes.**—Oscar Wyss has studied the "Herbststiris," a rainbow-like appearance seen on the calm surface of the

* Arch. Biontolog., ii. (1909) pp. 339-87 (3 pls.).

† Bull. Soc. Zool. France, xxxiv. (1910) pp. 223-9 (5 figs.).

‡ Tom. cit., pp. 234-40 (4 figs.).

§ Ann. Nat. Hist., v. (1910) pp. 51-4 (2 pls.). || Tom. cit., pp. 181-6 (1 pl.).

¶ Ber. Bayer. Biol. Versuch. München, ii. (1909) pp. 1-8 (1 pl. and 1 fig.). See also Zool. Zentralbl., xvii. (1910) p. 93.

** Rev. Suisse Zool., xvii. (1909) pp. 441-7 (1 pl.).

Lake of Zurich and elsewhere towards the end of October, and finds that it is due to the extraordinary abundance of the prism-shaped winter ova of *Daphnia longispina*.

New Fossil Barnacles.*—Thomas H. Withers observes that little has been done to British Cretaceous Cirripedes since the publication of Darwin's monograph, and he describes five new species from the British Museum collection.

Annulata.

Regeneration in Lumbricidæ.†—Janina Zielinska has studied the regeneration of the posterior end in species of *Lumbricus*, *Helodrilus*, and *Eisenia*. In general, what happens in the long thin regenerating bud is precisely like the process of embryonic development. There is, however, a mode of regeneration by a short, thick bud, which is probably divergent.

Young forms regenerate more rapidly than mature forms. Those cut far back regenerate more rapidly than those cut further forward.

A scar is formed which leaves the anus open. It consists at first of lymphocytes and subsequently of spindle-shaped cells from the longitudinal musculature which degenerates locally. There is abundant phagocytosis.

Cells migrate inwards from the epidermis and play an important regenerative role. It remains uncertain whether the mesoderm bands arise from mesoderm or from ectoderm. The reconstruction of musculature and blood-vessels is followed in detail.

Earthworms of Ruwenzori.‡—L. Cognetti de Martiis reports on a collection of twenty species, of which fifteen are new. The region seems to be exceedingly rich even at high elevations. The genera include *Alma*, *Dichogaster*, *Gordiodrilus*, *Pareudrilus*, etc.

American Polychætes.§—J. Percy Moore continues his laborious investigation of American Polychætes. He deals with a collection from Monterey Bay and San Diego, California—64 species, 21 new; and with the 'Albatross' || collection of Syllidæ, Sphaerodoridæ, Hesionidæ, and Phyllodocidæ from off the coast of Southern California.

Fossil Annelid Burrows.¶—F. A. Bather discusses fossil burrows referable to the work of *Polydora*, and brings together a number of instances. He also has notes on tubes referred to *Tigillites*, *Taonurus*, etc. "It seems probable that a large number of forms previously placed by geologists in a convenient receptacle labelled 'Fucoids' may now be safely regarded as due to burrowing Annelids."

B. S. Lyman ** records a burrow of *Scolithus linearis* with orifice

* Geol. Mag., vii. (1910) pp. 151-9 (14 figs.).

† Jen. Zeitschr. Naturw., xlv. (1909) pp. 467-526 (5 pls. and 3 figs.).

‡ Il Ruwenzori. Relazione Scientifiche, i. (1909) pp. 1-56 (4 pls.). See also Zool. Zentralbl., xvii. (1910) p. 81.

§ Proc. Acad. Nat. Sci. Philadelphia, lxi. (1909) pp. 235-95 (3 pls.).

|| Tom. cit., pp. 321-51 (2 pls.).

¶ Geol. Mag., vii. (1910) pp. 114-16.

** Proc. Acad. Nat. Sci. Philadelphia, lxi. (1909) p. 297.

complete in Cambrian rock. Crater-like orifices were seen precisely like those of the burrows of littoral Polychaetes. A form with a larger tube in Siluro-Cambrian limestone was referred by Torell to his genus *Monocraterion*.

Phascolosoma minutum.*—Georg Paul gives an account of *Petalostoma minutum* Keferstein, *Phascolosoma sabellarix* Théel, and *P. improvisum* Théel, and shows that they must be merged in *P. minutum* Keferstein. Perhaps *P. anceps* will have to follow. It is pointed out that *P. minutum* is hermaphrodite, the only certain case among Sipunculids. The author has also some notes on the structure of *Onchosoma steenstrupi*.

Parthenogenesis in *Dinophilus conklini*.†—Paul de Beauchamp finds that the nanism of the males is associated in this species with indubitable parthenogenesis. But this can only go on for several generations in the absence of males, and leads to a degeneration of the stock. This is very interesting in itself, and also in connection with the probable relationship between *Dinophilus* and Rotifers.

Nephridia of *Dinophilus* and of Larvæ of *Polygordius*, *Echiurus*, and *Phoronis*.‡—E. S. Goodrich describes in *Dinophilus* a new type of solenocyte formation, representing perhaps an intermediate step between the Platyhelminth "flame-cell" and the more typical Polychaete solenocyte, in which each tube, with its flagellum, has its own nucleus. This latter state might be reached by a multiplication of the nuclei until they came to correspond in number with the tubes. That *Dinophilus* is related to *Polygordius* has long been suspected; and it is interesting to note that in the larval nephridium of *Polygordius* there is a similar multiplicity of tubes. In *P. neapolitanus* a single nucleus, at the tip of each branch of the nephridial canal, controls a set of from six to seven solenocyte tubes. "The canal and solenocytes of the Annelid nephridium form a whole, a single organ derived from one rudiment, strictly comparable to the canal and flame-cells of the platyhelminth excretory organ." The author also discusses the solenocytes seen in the larvæ of *Echiurus* and *Phoronis*.

Oogenesis of *Sagitta*.§—Paul Buchner gives an account of the oogenesis in *Sagitta*, with some notes on maturation and fertilisation. The unequivocal persistence of the ovum chromosomes throughout the whole oogenesis is emphasized.

Australian Hirudinea.||—E. J. Goddard continues his studies on Australian Hirudinea, describing *Glossiphonia intermedia* sp. n., *G. heteroclita* (?), and *Limnobdella australis*. It is pointed out that the structure of the genital apparatus in *Glossiphonia* strengthens the view that the members do not copulate. Whitman has shown that hypodermic impregnation obtains in *G. parasitica*. It is interesting that all members

* Zool. Jahrb., xxix. (1909) pp. 1-50 (2 pls.).

† Comptes Rendus, cl. (1910) pp. 739-41.

‡ Quart. Journ. Micr. Sci., liv. (1909) pp. 111-18 (1 pl.).

§ Anat. Anzeig., xxxv. (1910) pp. 433-43 (17 figs.).

|| Proc. Linn. Soc. N.S.W., xxxiv. (1909) pp. 467-86 (2 pls.).

of any genus of Hirudinea from any part of the world fall into two groups, one of which has the genital apertures separated by one annulus, the other being characterised by the presence of two annuli between the pores. The author thinks that the primitive stock from which the Glossiphonid forms were derived was originally provided with a penial structure, and that the genital apertures were separated by a number of annuli, the pores being situated probably in successive somites.

Nematohelminthes.

Nematodes of the Eye.*—A. Railliet and A. Henry discusses the genus *Thelazia*, established by Bosc in 1819 for a Nematode from the eye of an ox. The parasite in question was afterwards called by Gurlt *Filaria lachrymalis*, but the male has a large number of pre-anal papillæ, the female has an anterior vulva (a short distance behind the end of the œsophagus), the buccal capsule opens directly into the œsophagus without a pharynx, and so on. The authors re-establish the genus *Thelazia*, and point out that its affinities are with *Ceratospira* (Schneider) and *Oxyspirura* (Drasche). They recognise five species: *T. rhodesi* (Desmarest) the type; *T. lachrymalis* Gurlt; and three new ones, *T. gulosa*, *T. alfortensis*, and *T. leesei*.

Filarix in Ixodes.†—Vincenzo Baldasseroni reports an interesting case of embryos of *Filaria quadrispina* (Diesing) occurring in the intestine of *Ixodes ricinus* parasitic on the beech-marten (*Mustela foina*). There were also many of the worms below the skin of the marten.

Genus Onchocerca.‡—A. Railliet and A. Henry propose to re-establish Diesing's genus *Onchocerca* for certain Filariidæ with thick cuticle found in the connective-tissue of Mammals. In addition to the type species, *O. reticulata* Diesing, the authors recognise *O. cervicalis* sp. n. in the ligamentum nuchæ of the horse, *O. armillata* Raill. and Henry in the wall of the aorta in cattle, *O. fasciata* sp. n. from a dromedary, and *O. volvulus* (Leuckart) from man.

Structure of Gordius.§—Jan Svábénik has made a minute study of many species of *Gordius*. From a study of some young stages in beetles and in an earwig he is convinced that the Gordiidæ must live several years in insects before they become sexual. A full account is given of the nervous system, with its ventral cord, cerebral ganglion, and anal ganglion. The cerebral ganglion of Gordiidæ cannot be compared with that of Annulates, for it develops late and probably by a differentiation of the ventral cord. Of considerable interest is the segmental evagination of the germinal epithelium in the females, for it is a suggestion of Annulate segmentation. The presence of a primary and a secondary body-cavity is also significant, and the author supports Vejdovsky's view that the Gordiidæ form an order (Nematomorpha) between Nematohelminthes and Annulata.

* C.R. Soc. Biol. Paris, lxxviii. (1910) pp. 213-16.

† Bull. Soc. Entomol. Ital., xl. (1909) pp. 171-4.

‡ C.R. Soc. Biol. Paris, lxxviii. (1910) pp. 248-51.

§ S.B. k. Böhm. Ges. Wiss., vii. (1909) pp. 1-64 (1 pl.).

Platyhelminthes.

Australian Triclad.*—Annie Weiss gives a detailed account of six new species of *Planaria* from Australian fresh water, paying particular attention to the epithelium, musculature, alimentary system, nervous system and sense-organs, and the reproductive organs.

New Type of Turbellarian.†—Paul Hallez describes an interesting new type, *Bothriomolus constrictus* g. et sp. n., which he found on the shore at Portel, in half-brackish water, at the level where *Procerodes ulvæ* is abundant. It is one of the Alloiocœla in the family Bothrioplanidæ, beside *Bothrioplana* and *Otoplana*. There is a sacciform gut much lobed and branched in the adult. Two ovaries lie in front of the pharynx. The copulatory organ has five lobes supported by spicules, the anterior lobe perforated by the ejaculatory duct. Eosinophilous glands open into the unpaired oviduct; cyanophilous glands open into a cavity homologous with the uterus of Tricladæ. There is an anterior and ventral ciliated pit, connected with a frontal sensory organ; there are no lateral ciliated pits. The animal creeps about without swimming. It is 5–6 mm. long by 0·5 mm. broad, constricted in front and behind the pharynx, opaque white in colour. Vibratile cilia are absent in the adult from the dorsal surface and on the median ventral line behind the pharynx. There are some filiform rhabdites in the caudal cells. The front and sides of the head bear stiff cilia. Numerous adhesive papillæ occur on the ventral surface, the margins, and the posterior end.

Turbellarians of the Gulf of Trieste.‡—H. Micoletzky gives a list: 12 Acœla in 5 genera; 25 Rhabdocœla in 17 genera; 19 Allœocœla in 8 genera, and about a dozen Polycladæ. He obtained most of his material among the *Zostera*.

Peculiar Trematode of the Mole.§—Richard Gonder describes *Itygonimus lorum* (Dujardin), an elongated cylindrical Trematode which occurs occasionally in the intestine of the mole. It has some points in common with *Harmostomum*, but stands markedly by itself.

Cuticula and Subcuticula of Trematodes and Cestodes.||—Henry S. Pratt has studied this much-discussed subject, and reached the following conclusions. 1. The cuticula of Trematodes and Cestodes is not homologous to that of other worms and of Arthropods. 2. The cuticula of Trematodes and Cestodes is the peripheral portion of the parenchyma, being composed mainly of secretions of it. 3. The subcuticula is not an epithelium or a hypodermis, but belongs genetically to the parenchyma. 4. The subcuticular cells are not present in the monogenetic Trematodes, in most of the Aspidobothridæ, and in many digenetic Trematodes, or in any Trematodes or Cestodes during the earliest larval stages, when the cuticula first forms. 5. The function of these cells is not known, and

* Zeitschr. wiss. Zool., xciv. (1910) pp. 541–604 (4 pls. and 1 fig.).

† Arch. Zool. Expér., xliii. (1910) pp. 611–64 (3 pls.).

‡ Arbeit. Zool. Inst. Univ. Wien, xviii. (1910) pp. 167–82.

§ Centralbl. Bakt. Parasitenk., liii. (1910) pp. 169–74 (1 pl. and 3 figs.).

|| Amer. Nat., xliii. (1909) pp. 705–29 (12 figs.).

although most authors have ascribed a glandular or secretory function to them, it seems likely that they form an indifferent embryonic tissue which develops into specialised tissues as the worm increases in size.

Tapeworms of North American Birds.*—B. H. Ransom deals with about 140 species of Tænioid Cestodes which have been reported from North American birds. These represent nearly forty genera, such as *Davainea*, *Liga*, *Rhabdometra*, *Hymenolepis*, and *Diorchis*. A key for identification is given, and the parasites are arranged not only systematically, but also according to their hosts. It may be noted that the Tænioid Cestodes are characterised primarily by the presence of four cup-shaped suckers upon the head, and form a natural group, classed by some authorities as a superfamily, Tænioidea, by others as an order, Cyclophyllidea.

Entozoa of Monotremes and Marsupials.†—T. Harvey Johnston gives a list of parasites, chiefly Cestodes, in various Monotreme and Marsupial hosts. Platypus yields a species of *Distomum*; the Echidna yields *Linstowia echidnæ* (Thompson); the kangaroo, *Macropus giganteus*, yields *Moniezia festiva* (Rud.), *Echinococcus polymorphus* Dies., *Distomum hepaticum*, and *Filaria websteri*; and so on.

Regeneration in Nemerteans.‡—J. Nusbaum and M. Oxner have studied this in *Lineus ruber*, and find that anterior parts can re-grow all the posterior organs. Posterior parts of the broader form of the species show little power of regenerating the head, while in the narrower form complete regeneration (ganglia included) is common. In the regeneration of the gut, the old gut plays no part; the new growth is due to de-differentiation of the elements of the wall of the rhynchocoelom. Old portions of the body are disrupted, and migrant cells supply material for the new histogenesis.

Nemerteans from Eastern Indian Ocean.§—R. C. Punnett and C. Forster Cooper report on twenty species, e.g. the following new species, *Drepanophorus indicus*, *Baseodiscus insignis*, *B. sordidus*, *B. longissimus*, *Lineus mascarensis*, *L. hancocki*, *L. indicus*, *L. crosslandi*, *L. orientalis*, *Cerebratulus multiporatus*, and *C. zebra*. A useful aid to the determination of species of *Lineus* and *Cerebratulus* is given in a table. The collection is remarkable for the presence of a species of *Tubulanus*—a genus not hitherto represented among any of the collections from the Indian Ocean. It is shown that the highly specialised *Diplopleura*—undoubtedly one of the most recent productions of the Lineid family—extends right across the Indian Ocean, finding its way eastwards to Japan and New Florida, and pushing up on the west into the Red Sea and the Mediterranean.

Protective Encystation of Fresh-water Nemertean.||—Paul Hallez describes how *Prostoma lumbricoideum* Dugès behaves when the water

* U.S. Nat. Museum, Bull. 60 (1909) pp. 1-141 (42 figs.).

† Proc. Linn. Soc. N.S.W., xxxiv. (1909) pp. 514-23.

‡ Bull. Internat. Acad. Sci. Cracovie, 1910, pp. 1-11 (1 pl.).

§ Trans. Linn. Soc. Zool., xiii. (1909) pp. 1-15 (2 pls. and 1 map).

|| Comptes Rendus, cl. (1910) pp. 481-2.

becomes foul or the temperature too low. It first bends on itself and remains quiescent for several days. If the unfavourable conditions continue, it surrounds itself loosely with mucus, which hardens in the water. Turning slowly round and round, secreting threads of mucus as it does so, it generally makes a cyst of concentric layers enormously bigger than itself. Within this it may remain absolutely quiescent for a month. The author also notes that *Tetrastemma dorsale* often encysts along the outside of the tube of *Tubularia indivisa*. The tubular cyst thus formed has the same structure as that of *Prostoma*, but the retreat is of short duration.

Summer and Winter Spawning in a Fresh-water Nemertean.*
Paul Hallez observed *Prostoma lumbricoideum* Dugès, spawning in an aquarium in October, November, and February. It deposited on the glass 10 to 15 eggs united by a mucous substance. The eggs developed quickly, hatching in 10 to 12 days. In December he also observed spawn, but very different. The worms formed a protective spherical cyst and filled them with eggs, about seventy in all. There was nutritive material around the eggs, and the development was very slow.

Ookinesis in *Cerebratulus lacteus*.†—Nashide Yatsu describes the maturation and fertilisation of the eggs of this Nemertean. We quote his general conclusions. The nuclear fluid is similar to hyaloplasm. It is usually neither alveolar nor reticular, but homogeneous. Diminution of chromatin (basichromatin) does not take place at the dissolution of the germinal vesicle. The centrosome is a temporary accumulation of cytoplasm around the centriole, which is a centre for the formation of rays. Its size is proportional to that of the cell. The spermatozoon carries a centriole in its middle piece into the egg at fertilisation. This gives rise to the cleavage centrioles, whose position is determined by the egg-organisation. Rays may be formed in homogeneous as well as in alveolar plasm. In fixed material fibrous and non-fibrous rays can be distinguished.

Incertæ Sedis.

Australian Fresh-water Polyzoa.‡—E. J. Goddard has taken up the study of these forms, to which little attention has been paid for over twenty years. He describes *Fredericella australiensis* sp. n., and gives a list of recorded species.

Indian Ocean Pterobranchia.—A. Schepotieff describes two interesting forms, *Rhabdopleura striata* sp. n., *Cephalodiscus indicus* sp. n. and its larva. In the new *Rhabdopleura* the raised tubes are built of plates arranged in regular circles; the stolon is hollow so that the trunk-cavities of the individuals are all in communication; there is a close general resemblance to *R. normanii* Allman. In the new *Cephalodiscus* the ccenocœcium has numerous separated cavities, each with a single aperture.

* Comptes Rendus, cl. (1910) pp. 556-7.

† Journ. Morphol., xx. (1909) pp. 353-401 (4 pls.).

‡ Proc. Linn. Soc. N.S.W., xxxiv. (1909) pp. 487-96 (1 pl.).

§ Zool. Jahrb., xxviii. (1909) pp. 429-48 (2 pls.).

Each cavity is occupied by a zooid and its buds. There are no terminal swellings on the lophophore arms. The sexes are separate, but occur on one cœnoecium. The head shield is very large, with little pigmentation. There are numerous pairs of buds. The eggs are unstaked. The new species belongs to the *Idiothecia* sub-genus. It is maintained inter alia that, as Allman suggested in 1876, Graptolites are related to Pterobranchia.

Echinoderma.

New Starfishes.*—W. K. Fisher describes some new species of *Pteraster* and *Hymenaster* from the North Pacific, and gives a synoptic table of the species in the first genus. He also defines *Thrissacanthias* g.n. (an Astropectinid near *Persephonaster* Alcock), *Gephyreaster* g.n. (near *Mimaster* Sladen), *Sphæroidiscus* g.n. (near *Pentagonaster*), and *Heterozonias* g.n., a Solasterid.

Echinoids and Asteroids from Mergui and Burma.†—R. N. Rudmose Brown reports on 15 species of Echinoids, including *Asthenosoma grubei* A. Ag., *Salmacis globator* (Bell), from the Mergui Archipelago and Moskos Island, Lower Burma. He also reports 19 species of Asteroids, three of which constitute new records for the Indian Ocean, namely, *Craspidaster hesperus* (M. and T.) Sladen, a Pacific species, and *Anthenea flavescens* (Gray) Perr., and *Pentaceros granulatus* Gray, both Australian forms.

Echinoids from Portuguese East Africa.‡—R. N. Rudmose Brown reports on a collection made by J. J. Simpson in the Kerimba Archipelago, Portuguese East Africa (Mozambique). The collection includes twenty-one species, among them a number of Pacific forms, such as *Lovenia subcarinata* and *Brissoisopsis luzonica*.

Asteroids from Portuguese East Africa.§—J. J. Simpson and R. N. Rudmose Brown report on fourteen species of Asteroids from the Mozambique coast. They make some interesting notes on colour variation, e.g. in *Pentaceros lincki* de Blainville. In the stomach of this species Simpson found Fierasfers, and saw the fishes passing in and out.

Reactions of Echinoderms.||—E. Mangold has made many experiments, especially on reactions to light and shade. He finds, for instance, a strong shade-reflex in *Arbacia pustulosa*, marked by movements of the spines. In Ophiuroids the light-sense has its seat in the whole skin, but the stimulus travels by the radial nerve. In *Ophioderma* the retreat of the animal is induced by illumining even the outermost two centimetres of one arm. In contrast to previous observers, Mangold found that the excision of the ocelli in starfishes made no difference to the light-reactions. In *Asterina gibbosa* and *A. pancerii* there is sensitiveness to the intensity of the light, the animals avoiding

* Ann. Nat. Hist., v. (1910) pp. 167-73.

† Proc. Roy. Phys. Soc. Edinburgh, xviii. (1910) pp. 21-35.

‡ Tom. cit., pp. 36-44.

§ Tom. cit., pp. 45-60 (4 figs.).

|| Zeitschr. Allgemein-Physiol., ix. (1909) 33 pp. See also Zool. Zentralbl., xvi. (1909) pp. 770-2.

both direct sunlight and darkness. The use of the eye-spot in starfishes is doubtful. There is a curiously prompt heliotactic reaction in *Pentagonaster placenta*, from deep water. There is marked negative-geotaxis in *Asterina* which disappears in foul water, and reappears when this is remedied. The sense is independent of the tip of the arm and of the central body.

Affinities of Echinoidea.*—Austin Hobart Clark gives reasons for his conclusion that the Crinoids and the Echinoids have much in common. They are much more closely related to each other than either group is to the Asteroids or the Ophiuroids. He proposes the following classification:—

Phylum—Echinodermata.

- I. Subphylum Echinodermata, Heteroradiata.
 - A. Pelmatozoa: Crinoidea, Cystidea, Blastoidea.
 - B. Ovozoa: Echinoidea.
 - C. Vermiformes: Holothuroidea (Bohadschoidea).
- II. Subphylum Echinodermata, Astroradiata.
 - A. Ophiobrachiata: Ophiuroidea.
 - B. Stellarides: Asteroidea.

Cœlentera.

Studies on Actinians.†—F. Pax has studied what seems to be *Polyparium ambulans*, which has been variously interpreted as an Anthozoon colony, a bilateral Actinian, or a fragment of a sea-anemone. Pax regards his specimen as the constricted off oral disk of *Stoichactis kenti* Haddon and Shackleton.

The author also reports on a collection of sea-anemones made by W. May at Gomera in the Canary Islands. Ten species occur, and there is closest affinity with the Actinian fauna of the Atlantic coast of Europe and the Western Mediterranean. But three species are peculiar to the Canaries—*Phellia vestita*, *Euphellia cinclidifera*, and *Palythoa canariensis*. Pax also describes *Bolocera norvegica* sp. n. from the west coast of Norway.

New Species of Cerianthus.‡—H. B. Torrey and F. L. Kleeberger describe from Southern California—*Cerianthus æstuari* sp. n. well marked by the small number of tentacles (never more than 34 of each kind); *C. benedeni* sp. n., resembling externally *C. americanus* and *C. membranaceus*, but differing from these and all other adult Cerianthids, so far as known, in possessing structures like the “botruenides” (aggregates of cnidoblasts) which van Beneden found in three pelagic Cerianthid larvæ; and *C. johnsoni* sp. n., very closely resembling *C. membranaceus*, but differing in the arrangement of the mesenteries in the region of the siphonoglyph.

Rhythm in Sea-anemones.§—Georges Bohn finds that when the perturbations due to the tides are eliminated, *Actinia equina* always

* Amer. Nat., xliii. (1909) pp. 682-6.

† Jen. Zeitschr. Naturw., xlv. (1909) pp. 325-44 (1 pl. and 3 figs.).

‡ Univ. California Publications (Zool.) vi. (1909) pp. 115-25 (4 figs.).

§ C.R. Soc. Biol. Paris, lxxviii. (1910) pp. 253-5.

shows a marked "nycthemeral" rhythm. This is more marked in the Mediterranean than in the Channel, for in the former the sensitiveness to variations in illumination is very acute. The rhythm persists even after a period of continuous darkness. Light is the determining factor in the rhythm, which the chemical changes only perturb.

New Species of Cactogorgia.*—J. J. Simpson describes *Cactogorgia agariciformis* sp. n., a rather striking Alcyonarian (of unknown origin) in the collection of the Royal Scottish Museum, Edinburgh. The other species, four in number, have been recorded from the Indian Ocean. The author contrasts the new species with the others.

New Pseudaxonid Genus Dendrogorgia.†—J. J. Simpson describes a *Juncella*-like Alcyonarian, *Dendrogorgia capensis* g. et sp. n., from the Cape, which turns out to be a Pseudaxonid. There is a sclerogorgic axis, without solenia, built up of spicules embedded longitudinally in a horny matrix. The thick cœnenchyma is packed with double and triple stars. The canal system consists of an inner longitudinal series separating the axis from the cœnenchyma, and an outer longitudinal series near the periphery, the two being connected by a network of small transverse solenia. The polyps occur all over, and are completely retractile. Hickson's *Juncella elongata* var. *capensis* must be included in this type.

Medusæ of the Gulf of Trieste.‡—Valeria Neppi discusses in particular the form without cirri known as *Irene pellucida* Will. (which is shown to be the same as *Geryonia pellucida* Will.), and the related form without cirri for which the new name *Tima plana* is suggested.

Life-cycle of Eleutheria.§—Du Plessis has succeeded by the method of isolation in observing, what has hitherto baffled observers, the complete alternation of generations in this hydroid—in other words, the *Eleutheria* and the *Clavutella* stages. He also points out that the common *Eleutheria* of the Mediterranean is different from *E. dichotoma*, and proposes *E. gemmipara* as its name.

New Gymnoblasic Hydroid Epizoic on a Pennatulid.||—Winifred E. Coward describes *Ptilocodium repens* g. et sp. n., growing on the tips of the pinnules of *Ptilosarcus sinuosus*. It is a very remarkable form, seeming to have some affinities with *Hydractinia*, *Podocoryne*, and *Millepora*, as shown by the sheet-like, encrusting basal cœnosarc, from which the zooids arise independently; but even in this character it stands alone in having no chitinous or calcareous skeleton to support it.

Moreover, it is peculiarly dimorphic. The gastrozooids are short, sessile, sac-like structures without tentacles. The dactylozooids are short and broad, with four characteristic capitate tentacles. There are adelocodonic gonophores arising from the base of the ordinary gastrozooids. In fact, this new type stands quite apart, and requires a family for itself.

* Proc. Roy. Soc. Edinburgh, xxx. (1910) pp. 324-6 (1 pl.).

† Proc. Roy. Phys. Soc. Edinburgh, xviii. (1910) pp. 62-7 (4 figs.).

‡ Arbeit. Zool. Inst. Wien, xviii. (1910) pp. 157-66 (5 figs.).

§ Rev. Zool. Suisse, xvii. (1909) pp. 371-7.

|| Proc. Section of Sciences Akad. Amsterdam, xi. (1909) pp. 635-41 (1 pl.).

Hydrocoralline from Rockall.*—J. Arthur Thomson records the occurrence of *Stylaster gemmascens* from Rockall in the North Atlantic.

Fossil Corals from Ceram.†—H. Gerth discusses an interesting Hydrozoon fossil from East Ceram which turns out to be a species of *Herastridium*. He also discusses what Tornquist called *Neostroma*, and shows that it is neither a Hydrozoon (Stromatoporoid) nor a Spongimorphid, but a kind of *Actinacis*.

Porifera.

New Monaxonids.‡—E. Topsent discusses the species of the peculiar Monaxonid sponges belonging to the genus *Cladorhiza*, and describes a well-defined new species *C. grimaldii* from near Madeira and *C. thomsoni* dredged by the 'Scotia' (W. S. Bruce) between Gough Island and the Cape. He also establishes a new genus *Euchelipluma*, closely allied to *Asbestopluma*.

Hexactinellid Sponge Spicules and their Names.§—R. Kirkpatrick points out that there are two main groups—one ("holactine") in which all the rays have an axial canal, the other ("astral") in which the central end is hollow and the rest solid. The part of the ray with the axial canal is here termed the "actine," the solid part or parts of the so-called ray or ray-system being termed end-spines or "distal appendages." Holactine spicules have only actines. Astral spicules have end spines or distal appendages at the ends of the actines. The author works out a detailed classification of the forms of hexactinellid spicule belonging to these two groups.

Merlia normani.||—R. Kirkpatrick has come to the conclusion that this remarkable sponge has both a calcareous and a siliceous skeleton. It is not a parasite growing over and into a calcareous organism; it is now beyond doubt seen to be a sponge, and nothing but a sponge. It is of unique interest, not only in itself, but also on account of the resemblance, in some respects, of its calcareous skeleton to certain of the Monticuliporas.

Affinities of *Astrosclera willeyana*.¶—R. Kirkpatrick refers to this interesting form, which J. J. Lister regarded as an aberrant calcareous sponge. Further investigation has led Kirkpatrick to conclude that it is a siliceous Ectyonine sponge related to *Hymenaphia*. It does not secrete aragonite, as was supposed, but has a supplementary skeleton formed of foreign particles of aragonite, at first discrete, and afterwards welded into concrete walls and blocks.

Development of *Sycon raphanus*.**—Ernst Hammer describes the ova and their growth, e.g. how the young amœboid cells ingest and

* Proc. Roy. Phys. Soc. Edinburgh, xviii. (1910) p. 61.

† SB. Nat. Ver. Preuss. Rheinlande, 1909, pp. 17-25 (8 figs.).

‡ Bull. Inst. Océanographique, No. 151 (1909) pp. 1-23 (2 pls.).

§ Ann. Nat. Hist., v. (1910) pp. 203-13 (1 pl.).

|| Tom. cit., pp. 288-91.

¶ Tom. cit., pp. 380-3 (1 pl.).

** Arch. Biontolog., ii. (1909) pp. 291-334 (6 pls.).

assimilate their neighbours. He discusses the maturation and fertilisation, the free-swimming amphiblastula stage, the process of invagination (forming a cavity which does not seem to be continuous with the subsequent gastral cavity), the fixation, and so forth. The difficulties in interpreting the gastrulation are dealt with.

Protozoa.

Treatise on Protozoa.*—F. Doflein has expanded his book on "Protozoa as Parasites" into a large treatise on Protozoa. He discusses in the introductory portion the structure, functions, behaviour, reproduction, and relationships of the Protozoa, and then passes to a systematic survey in which special attention is devoted to the pathogenic forms, such as Trypanosomes and Spirochaets.

Shaking Experiments with Protozoa.†—Max Morse has tried whether Protozoa are like Protophytes in being killed or made quiescent by prolonged shaking. He worked with *Paramecium*, *Euglena*, and *Stylonichia*, and found that shaking for an hour had little effect, except that *Paramecium* became somewhat less active. After horizontal shaking for six hours *Paramecium* and *Euglena* became sluggish. Twenty-four hour periods gave decided results, the two species just mentioned being either killed or rendered very sluggish. In all cases a few individuals were nearly normal. Experiments with *Stylonichia* showed no change. Shaking does not seem to affect the division rate in *Paramecium*. The sluggishness is not due to lack of food nor to tetanus. It is possibly due to destruction of enzymes.

Parasitic and Commensal Marine Infusorians.‡—Emile André describes *Eurychilum actiniæ* g. et sp. n., a holotrichous Ciliate in the family Chilifera, from the cavity of *Sagartia*; *Orthochona anilocræ*, g. et sp. n., a peritrichous form from *Anilocra* (parasitic on Labridæ); *Conchophthirus antedonis* sp. n., in the food-canal of Comatula; and has notes on a number of other forms.

Notes on Choanoflagellata.§—J. S. Dunkerley makes some notes on the division of *Salpingoeca vaginicola*, which is very common at Plymouth, and on *Polyoeca dichotoma*, which does not seem to have been observed since Saville Kent described it more than twenty years ago. The main interest of this form lies in its faculty for colony formation, and in the daughter-individual erecting its lorica on the mouth of the mother-individual's lorica.

Trichomonad with Four Anterior Flagella.||—A. Alexieff found in the rectum of salamander, newt and obstetric frog a new species of *Trichomonas*, which he names *T. prowazeki*, distinguished by having four unequal flagella.

* Lehrbuch der Protozoenkunde. Jena: 1909, 914 pp., 825 figs.

† Proc. Soc. Exper. Biol. and Medicine, vii. (1910) pp. 58-60.

‡ Rev. Suisse Zool., xviii. (1910) pp. 173-87 (1 pl.).

§ Ann. Nat. Hist., v. (1910) pp. 168-91 (2 pls. and 4 figs.).

|| C.R. Soc. Biol. Paris, lxxvii. (1909) pp. 712-14.

New Suctorina.*—B. Collin gives preliminary diagnoses of four new species of *Acineta*, of *Acinetopsis campanuliformis* sp. n., *Ophryodendron reversum* sp. n., and of two new genera *Rhynchophrya* on *Hydrophilus* and *Dactylophrya* on marine hydroids.

Studies on Trypanosomes.†—A. Laveran discusses *Trypanosoma congolense* Broden from domestic animals in the Congo area, relating experiments as to its pathogenic effect on various Mammals, and distinguishing it from *T. dimorphon* and other species. A. Carini‡ describes the endoglobular stages of various species of Trypanosome, e.g. in the blood of *Leptodactylus ocellatus*, and points out that during the first stages it is impossible to differentiate them from Hemocytosoa in the strict sense, for there is no trace of the characteristic locomotor apparatus (blepharoplast, flagellum and undulating membrane).

New Trypanosome in a Vole.§—A. Laveran and A. Pettit describe *Trypanosoma microti* sp. n., which they found in a vole, *Microtus arvalis*, where it seems to have no pathogenic influence. Attempts to inoculate mice and wood-mice with this new form were unsuccessful. The authors distinguish it from *Trypanosoma lewisi*, *T. duttoni*, *T. grosi*, and other species.

Trypanosome of a Gecko.||—G. Catouillard describes *Trypanosoma platydactyli* sp. n., from the common gecko of Tunisia (*Platydactylus muralis*), and distinguishes it from other species recorded from other geckos.

Trypanosome in Alimentary Tract of Pontobdella muricata.¶ Muriel Robertson brings forward strong evidence that the trypanosome in the leech *Pontobdella* is *Trypanosome raiaæ*, from the skate. She gives an account of the trypanosome phase as found in the intestine of the leech and of its development from the resting-form.

Transmission of Trypanosoma lewisi by Rat-flea.**—E. A. Minchin and D. Thomson find from their experiments that the rat-flea (*Ceratophyllus fasciatus*) can transmit *Trypanosoma lewisi* from infected to non-infected rats. The transmission takes place by the cyclical method. Transmission by the direct method has not been proved. The incubation-period of the flea, that is to say, the period occupied by the developmental cycle of the trypanosome, has a minimum length of six or seven days, but may be longer. The multiplication-period of the trypanosome in the rat has a length of about twelve days. In the developmental cycle the establishment of the trypanosome in the flea begins with multiplication of *Crithidia*-like forms in the rectum.

Amakebe and East Coast Fever.††—David Bruce, A. E. Hamerton, H. R. Bateman, F. P. Mackie have reached the following conclusions:—

* Comptes Rendus, cxlix. (1909) pp. 1094-5.

† Ann. Inst. Pasteur, xxiv. (1910) pp. 81-95. ‡ Tom. cit., pp. 143-51 (1 pl.).

§ C.R. Soc. Biol. Paris, lxxvii. (1909) pp. 793-800.

¶ Tom. cit., pp. 804-5 (6 figs.).

¶¶ Quart. Journ. Micr. Sci., liv. (1909) pp. 119-39 (1 pl. and 5 figs.)

** Proc. Roy. Soc., Series B, lxxxii. (1910) pp. 273-85.

†† Tom. cit., pp. 256-72 (1 pl.).

1. The blood of cattle in Uganda almost always contains *Piroplasma bigeminum* and *P. mutans*, and the cattle are, therefore, immune to these two diseases. 2. The disease of calves called Amakebe is the East Coast Fever discovered by Koch, so that very many of the cattle in Uganda are almost immune to this disease. 3. Owing to the nature of East Coast Fever, inasmuch as animals recovered from the disease are no longer infective, some calves may escape attack of Amakebe, and so remain susceptible. 4. Thus the calves of the Sesse Islands escape Amakebe, and when as grown-up cattle they are transferred to the mainland, they mostly die of the East Coast Fever. 5. The carriers of East Coast Fever—*Rhipicephalus appendiculatus*, or brown tick; *R. evertsi*, or red-legged tick; and *R. simus*—are all common in Uganda.

Mastigamœbæ.*—E. Penard gives an account of some of these interesting forms which have amœboid characters combined with the possession of a genuine flagellum. It may be rudimentary and it is often useless, but it is a true flagellum, with the characteristic basal granule. Penard deals with forms which occur in the vicinity of Geneva—*Mastigamœba aspera* F. E. Schulze (= *Dinamœba mirabilis* Leidy), two new species of *Mastigamœba*, two of *Mastigina*, and one of *Mastigella*.

New Parasitic Amœba.†—E. Chatton describes *Amœba mucicola* sp. n., which he found as a parasite on the gills of a Labrid fish (*Symphodus tinca*), and associated with an Infusorian belonging to the genus *Trichodina* among the Ciliata. The fishes die with all the signs of asphyxiation, but it is not proved that *Amœba mucicola* is an habitual parasite. Some minute amœboid forms, perhaps young stages of the amœba, were seen inside some specimens of *Trichodina* and developing there.

Leucocytozoon of the Fowl.‡—C. Mathis and M. Leger find that there is a certain periodicity in the appearance of the sexual forms of *Leucocytozoon caulleryi* in the peripheral circulation of the fowl. They may be absent for forty days or for twenty-one. It is not known what organs are the seat of schizogony and of the development of the adult forms. Nor is the invertebrate host known in which the sexual multiplication occurs.

Notes on Parasitic Protozoa.§—T. Harvey Johnston has notes on *Leucocytozoon (Hæmogregarina) muris* Balfour from *Mus alexandrinus* and *M. decumanus*, *Halteridium nettionis* sp. n. from a teal (*Nettion (Anas) castaneum*), *Plasmodium passeris* sp. n. from the common sparrow, and a number of other forms.

Hæmogregarines in Australian Reptiles.||—T. Harvey Johnston describes three new species: *Hæmogregarina morellæ*, from a carpet-snake (*Python*), *H. pseudochis*, from a black snake (*Pseudochis*), and *H. clelandi*, from a tortoise (*Chelodina*).

* Rev. Suisse Zool., xvii. (1909) pp. 405-39 (2 pls.).

† C.R. Soc. Biol. Paris, lxxvii. (1909) pp. 690-2. ‡ Tom. cit., pp. 688-90.

§ Proc. Linn. Soc. N.S.W., xxxiv. (1909) pp. 501-13 (1 pl.).

|| Tom. cit., pp. 400-10 (2 pls.).

Coccidian in Bile-ducts of Agama.* — A. Laveran and A. Pettit give a short account of *Coccidium agamæ* sp. n., from the epithelial cells of the gall-bladder and bile-ducts of *Agama colonorum*. Very few Coccidians have been recorded from reptiles, and the seat of the infection is peculiar.

Nuclear Hypertrophy induced by Microsporidia.† — A. Schuberg describes the abundant occurrence of *Plistophora longifilis* sp. n. in the testis of the barbel, and calls attention to the very striking hypertrophy of the nuclei in the testicular tissue. This may have some significance in connection with the pathological interpretation of tumours.

* C.R. Soc. Biol. Paris, lxxviii. (1910) pp. 161-3.

† Arbeit. k. Gesundh. Berlin, xxxiii. (1910) pp. 401-34 (4 pls.).



BOTANY.

GENERAL,

Including the Anatomy and Physiology of Seed Plants.

Cytology,

including Cell-Contents.

Connecting Threads between Nucleus and Chromatophores.*—B. Lidfors has examined *Ranunculus Lingua*, *Bellis perennis*, *Pyrola minor*, *Sempervivum arboreum*, *Solanum tuberosum*, *Hyacinthus orientalis*, *Asplenium decussatum*, and other vascular plants. The author finds that in the epidermal cells, assimilatory tissue of leaves and cortical parenchyma of the stem of all the plants examined, the cell-nucleus is surrounded by a kinoplasmic sheath which passes out into slender threads connected on the one hand with the nucleus itself, and on the other, either directly or indirectly, with the chloroplasts and hyaloplasm. Elioplasts have similar connecting threads, as have also the leucoplasts of starch-storing rhizomes and bulbs. These threads occur in plants widely separated in systematic position and manner of growth, and the writer is of the opinion that the phenomenon is general throughout the higher plants, although the structure of the kinoplasmic sheath and threads may differ somewhat according to age, temperature, and other conditions. No attempt has at present been made to discover whether such threads are found in the Thallophytes, although analogy makes it probable. The chemical nature of the threads has not been ascertained, and neither is it yet possible to be sure as to their physiological function, but it seems probable that they serve for exchange of material between the nucleus and cytoplasm, and also that they are channels of communication of the influence of the nucleus over other parts of the protoplast.

Form and Change of Position of Chromatophores.†—G. Senn has made further experiments with respect to chromatophores, chiefly with regard to their position during winter and their behaviour in connection with cell-division. The author finds that the crowding together of the chloroplasts at the bottom of the palisade-cells during winter is the result of a local action of frost, which causes the protoplasm and its contained chloroplasts to have a negatively thermotactic movement. This movement is confined to those cells which are adjacent to the upper epidermis, and is thus different from that caused by varying intensity of light. If, however, the leaf is inverted, a similar movement occurs in cells of the spongy parenchyma. The movement can only take place either just before the cells of the leaf are frozen or just after they have begun to thaw. The movement of one of the two daughter-chromatophores formed in connection with cell-division, as observed in

* Acta Univ. Lund., n.s. iv. (1908-9) pp. 3-40 (4 pls.).

† Ber. Bot. Gesell., xxvii. (1909) pp. 12-27 (7 figs.).

Synedra Ulna, is a special case, and unlike other such movements is not shared by all the chromatophores at the same time, but successively according to age. The tendency of the daughter-chromatophores to separate as far as possible from one another is probably connected with their need to obtain the requisite amount of light and nourishment.

Chromosomes in *Osmunda*.*—S. Yamanouchi has studied the chromosomes in *Osmunda cinnamomea* during both homotypic and heterotypic mitoses, and finds that the reticulum of the young nucleus consists mainly of chromatin material, and arises from the chromosomes of the previous division. There is no indication of pairing of knots or strands in the chromatin network during the resting stage. Although it is difficult to trace the limits of the chromosomes during the resting stage, they appear to retain their individuality. Pairing of chromatin material occurs only during the prophase of heterotypic mitosis. The pairs are in closest association during synapsis, but no actual fusion occurs. No splitting takes place during heterotypic mitosis, but the bivalent chromosomes result from the association of two independent chromosomes. Separation of each pair gives an appearance of longitudinal splitting.

Structure and Development.

Vegetative.

Physiological "Separating-Layers" in Gymnosperms, Equisetaceæ, and the Bryophytes.†—M. Plant publishes the results of extensive observations made upon Gymnosperms, *Equisetum* and Bryophytes as to the presence and significance of the endodermal layer. The Gymnosperms examined include members of the Cycadaceæ, Coniferae, Ginkgoaceæ, and Gnetales. The Cycadaceæ have a specially characteristic endodermal layer. All the Cycads and most of the Taxaceæ, Cupressineæ, and Taxodeæ have an "intercutis" in their roots, but this is absent in all the Gnetales and usually in the Abietineæ. The development of the endodermis is alike in all Gymnosperms, and there is always a primary and a secondary endodermis. In the hypocotyl the endodermis varies much in all Gymnosperms, but a primary endodermal layer is usually present. The aerial axis has neither endodermis nor starch-layer, and this is also true of the leaves. The latter possess semi-cutinised cells, the function of which is still unknown. Some new and interesting facts concerning *Equisetum* have been brought to light. The cuticle of the epidermis of the aerial stem is normal, but that of the rhizome is variable. Lignin is only present in the vascular bundles and in the spiral thickenings of the sporophylls. This latter fact appears to be of phylogenetic importance in connection with this group. Suberised and cutinised cell-lamellæ are not present, neither is there any "intercutis" or cork-formation. A primary endodermis is always present. The Bryophytes cannot be shown to possess any endodermal layer.

Saxifragaceæ.‡—E. Warming has studied the arctic species of Saxifragaceæ with the following results. There are five types of stem-structure, viz., the *Primula* type with a vertical, sympodial rhizome and

* Bot. Gaz., xlix. (1910) pp. 1-12 (1 pl.).

† Jahrb. wiss. Bot., xlvi. (Leipzig, 1910) pp. 121-85 (3 pls. and 1 fig.).

‡ Structure and Biology of Flowering Plants, i. (1909) pp. 168-236 (40 figs.). (Reprint from Meddel. om Grönland, xxxvi.)

leaves in a rosette; a second type similar to the first but less pronounced and accompanied by bulbils or runners with scale-leaves and adventitious roots; the third type, resembling that of *Sempervivum*, has a vertical stem and a rosette of foliage-leaves: it dies away entirely after flowering, and growth is continued by lateral shoots; the fourth type is a "many-headed rhizome," the primary root of which lives a long time; the fifth type is that of the creeping-herb with prostrate shoots and elongated internodes. The leaves of the vegetative shoots are true foliage-leaves; scale leaves only occur in connection with bulbils and runners. The flowers are fully developed in the year previous to that in which they open, but both pollen and ovules are immature until the year of opening. Staminate flowers are rare, but pistillate flowers are common, being usually terminal and smaller than the hermaphrodite flowers. The terminal flowers also vary somewhat in their number of parts, being sometimes hexamerous and pentamerous. Pollination is usually performed by insects. Protandry is common, but is not to be regarded as a generic character. Protogyny occurs in some cases. Self-pollination is common, and the staminal movements are the same as are usually found in the Saxifragaceæ. Fruit-setting and seed-formation are common except in those plants which have bulbils or other methods of vegetative propagation.

Histology of Giant and Ordinary *Primula sinensis*.*—R. P. Gregory contributes a note upon *Primula sinensis*, in which he gives the results of numerous observations mostly bearing upon the histology of the two forms. The seeds of the giant varieties are usually larger and flatter than those of the ordinary form. Microscopic examination of various epithelial layers, e.g. those of the young stigma, also of the nuclei of the pollen-mother-cells, shows that the two forms have the same number and form of chromosomes, but that there is a difference in size. There is a corresponding difference in the size of the resting nuclei and in the cells.

Classification of the Aloes by Leaf-structure.†—F. Lange publishes an account of a long series of observations upon the leaf-structure of the aloes. The author has studied the genera *Aloe*, *Gasteria*, *Haworthia*, *Apicra*, and *Lomatophyllum*, and is of the opinion that they may be classified by means of the anatomical structure of the leaf, and publishes a scheme whereby the relationship of the above genera is clearly shown. The limits of the present classification do not always correspond with those of existing classification, but close examination shows that the differences are immaterial. The structures that form the basis of the present system of arrangement are the general external form of the leaf, the formation of the epidermis, more especially of the cuticle, the structure of the vascular bundles, and, lastly, the nature of the crystals accompanying the raphides.

Reproductive.

Embryology of *Encephalartos*.‡—W. T. Saxton has studied the development of the embryo of *Encephalartos*, and shows that the sus-

* Proc. Camb. Philos. Soc., xv. 3 (1909) pp. 239-46.

† Bot. Zeit., lxxviii. (1910) pp. 1-47 (33 figs.).

‡ Bot. Gaz., xlix. (1910) pp. 13-18, 1 pl. (1 fig.).

ensor originates in a group of cells at the proximal end of the embryo. This same group of cells at a later stage forms the root-meristem. In one instance branching of the embryo gave rise to two approximately equal embryos. The rapid growth of two groups of apical meristematic cells initiates the cotyledons. Lysigenous canals, containing both tannin and mucilage, arise before the foliage leaves are differentiated. The fused cotyledons are very intimately connected. Morphologically the suspensor is a root-cap. There is a close resemblance between the embryology of *Encephalartos* and that of *Ginkgo*.

Pollination-mechanism in Ricinus.*—C. Steinbrinck has examined the anthers of *Ricinus* in order to test the statements made by Ludwig and Delpino as to the distribution of the pollen. The author finds that not only are these statements correct, but that we have here a phenomenon analogous to that found in the sporangia of Ferns and Selaginellas. The splitting of the anthers is due to a cohesion-mechanism, but the right-sided splitting is not so certain as in the ferns, and the means by which it is brought about is less well marked. As in the ferns, the anther-walls, at the time of pollen-ripening, consist of only a single layer of cells, and the outer epidermis is entirely absent. The reason for this behaviour of the anthers is not at present evident.

Germination of Seeds of Parasitic Plants.†—M. E. Heinricher summarises the results of his investigations into the seed-germination of parasites, especially of the Rhinanthææ. The following aspects of the germination processes are considered:—1. The seeds of some species will not germinate unless placed in contact with the roots of a suitable host. Such are the seeds of *Lathræa* (*L. squamaria* and *L. clandestina*) and of *Tozzia* (*T. alpina*). In other cases,—e.g. *Euphrasia* (sens. lat.), *Alectorolophus*, *Bartschia*—germination occurred by planting in a pot containing soil free from all host-tissues. 2. Conservation of germinating power by dried seeds. In some cases—e.g. *Melampyrum pratense*—the seed will not germinate if dried for a short time. The same applies to *Thesium*, *Lathræa*, and *Tozzia*. The seeds of the latter germinate entirely enclosed in the nut-like fruit, the radicle and plumule ultimately bursting the fruit-wall. Cotyledons are never produced above ground: development for the first two or three years is holoparasitic and subterranean; a subaerial leafy shoot appears ultimately, and the plant flowers, fruits, and dies, the whole of its subaerial existence occupying but a few weeks. The seeds of *Thesium*, and of *Santalum album*, would not germinate unless planted in the soil enclosed in the fruit. Others of the Santalaceæ were, however, found to be less sensitive; seeds of *Osyris* and *Commandra*, sent in a dried state from Calcutta, were made to germinate successfully. In disagreement with Gautier, the author finds that drying does not destroy the power of germination in the Rhinanthææ generally, nor in *Pedicularis*. He agrees with Gautier in concluding that sensitiveness to drying depends upon the degree of development of the embryo. 3. The season of germination is very irregular. In the case of *Lathræa*, germination may occur in the autumn

* Ber. Bot. Gesell., xxviii. (1910) pp. 2-7.

† Rev. Gén. Bot., xxi. (1909) pp. 329-34.

following maturity; but the seed may remain buried for some years before it germinates. In *Euphrasia* (sens. lat.) and *Alectorocephalus*, germination never occurs before the spring following maturity.

The paper contains other interesting matter respecting flowering parasites or hemiparasites. The author concludes from his observations upon *Lathræa* and *Odontites verna* that the production of root-suckers (haustoria) is the result of chemical attraction exerted by nutritive host-tissue. Summarising his conclusions from *Euphrasia* and *Alectorocephalus*:— 1. These so-called hemiparasites are not very selective in their choice of a host. 2. The degree of parasitical dependence varies with the species. 3. The greater the degree of dependence, the less active the formation of root-hairs. 4. The actual parasitism consists in the absorption of nutritive salts (*Paliment primitif*) from the host-roots. The leaves of green parasites are usually highly differentiated morphologically and anatomically, and these plants need ample illumination, being highly active in photosynthesis. In the case of the ephemeral *Tozzia alpina*, however, the assimilatory tissue is very imperfectly differentiated, and photosynthetic power much reduced in consequence.

Change in Direct Sunlight during its Passage through Foliage.*

J. Wiesner has made further investigations concerning the relations between plants and sunlight, with interesting results. The author finds that while diffused light is of the highest importance to plants, and direct sunlight never reaches the leaves as such, there are various adaptations for protection against direct light, and for making the best possible use of it. The latter is especially noticeable during cold seasons and in cold climates. The present work shows that plants reduce the strength of direct sunlight so as to obtain full benefit from it, in two different ways: first, through the formation of sun-pictures, and secondly, through a dispersing of the light in the leaves themselves. Sun-pictures are formed by the passage of the light through the spaces in the leaves, and the intensity of the light is in inverse ratio to the square of the distance penetrated. Sun-pictures produced by small gaps are equally illuminated over their whole surface, while those produced by larger gaps have a greater intensity of light at the centre and less towards the outer limits of their surface. When the large leaves of trees overlap so as to shut off the light from the lower leaves, this disadvantage is overcome by the formation of pinnate leaves which allow of the formation of sun-pictures on the lower leaves. When the leaves are most numerous and diffused light is thus largely cut off from the lower leaves, then is the conversion of direct sunlight into diffused light through the formation of sun-pictures most in evidence. The above only applies to plants with numerous leaves. Plants having only few leaves rely upon the surrounding trees and shrubs for regulation of their light-supply. The cell-contents themselves play an important part in converting direct sunlight into diffused light.

Respiration of Vegetative Organs of Vascular Plants.†—G. Nicolas has studied the normal respiration of the vegetative organs of a large

* SB. k. Akad. wiss Wien, cxviii. (1909) pp. 759–812 (11 figs.).

† Ann. Sci. Nat. Bot., x. (1909) pp. 1–113.

number of vascular plants, including many Phanerogams, a Fern, and one species of *Equisetum*. The author finds that by obstructing a part or the whole number of the stomata by smearing the surface of the leaf with vaseline or any similar substance, the normal respiratory intensity is more or less diminished, the respiratory quotient is increased, the ratio $\frac{1}{N}$ is increased, but there is no apparent effect upon the amount of anaerobic CO₂ set free. A similar experiment in connection with transpiration shows that obstruction of the stomata decreases transpiration. The results tend to show that gaseous exchange takes place chiefly through the cuticle, while water-vapour passes mainly through the stomata. A few experiments have also been made in order to discover whether there is any connection between the amount of chlorophyll present and the respiration. It would appear that an abundance of chlorophyll augments the respiratory intensity, and vice versâ. The author regards the results obtained as favourable to the "Zymastic Theory."

Physiology.

Irritability.

Influence of Gravity on Growth of *Amanita*.*—S. G. Streeter has studied the influence of gravity on the direction of the growth of *Amanita phalloides* and *A. crenulata*, with the object of determining the reaction of common toadstools to the stimulus of gravity. As the forms used were positively heliotropic, the experiments were performed in a moist dark chamber. When young and strong specimens were placed with the stipe in a horizontal position, the latter bent so as to place the pileus in a horizontal position. Supra-curvature sometimes occurred, but was neutralised unless the growth ceased too soon. The responsive zone is in the tip of the stipe, and not in the pileus. Elongation takes place throughout the length of the stipe, but is ultimately confined to the short zone just below the pileus. The duration of the necessary stimulus is less than one minute. The latent period was from 40 to 60 minutes, but younger specimens responded more quickly than older ones.

Chemical Reagents in Relation to Wheat-seedlings.†—H. S. Reed has investigated the transpiration in relation to the growth of wheat-seedlings when under the influence of certain chemical reagents. Phosphates of lime and sodium increase transpiration, while salts of potassium decrease it. Inorganic acids retard transpiration, while variable results were obtained with organic acids. Pyrogallol and tannic acid increase transpiration. All the effects produced by the different chemicals appear to be due to the activity of the ions, e.g. ions of potassium always produce an inhibiting action, irrespective of the acid ions present. Substances such as oxalic acid, pyrogallol, etc., which occur naturally in plants appear to influence transpiration independently of other factors. Further investigations on the lines of the present work would probably result in practical advantages in agricultural operations.

* Bot. Gaz., xlviii. (1909) pp. 414-26 (13 figs.).

† Op. cit., xlix. (1910) pp. 81-109 (9 figs.).

Chemical Changes.

Blackening of Green Leaves.*—L. Maquenne and Demoussy contribute a further note upon the causes of the blackening of leaves. The plants used for experiment were the fig and privet, which are very sensitive to electric light, and the ivy and *Aucuba*, which are less so. The experiments included the plunging of a portion of the leaf into hot or boiling water for a short time, or treatment in an atmosphere of chloroform vapour. In both these cases blackening of the portion of leaf thus treated took place slowly when exposed to electric light. Although it appears probable that the phenomenon is of diastatic origin, it cannot be proved that any oxydase takes part in the reaction. If the leaves are completely immersed in the hot water, so as to destroy all diastases contained in the leaf, no blackening results under the influence of electric light. The present experiments confirm the previous conclusions of the author, viz., that blackening of the leaf is not a specific result of the ultra-violet rays but is also brought about by heat, action of chloroform, and mechanical bruising, all of which kill the protoplasm, and bring about a mingling of the cell-sap. The phenomenon is the result of diastatic action.

General.

Williamsonias of Mixteca alta.†—G. R. Wieland has examined the fossils of the Rhät-Liassic beds of the plateau and mountain region of the Mixteca alta in Mexico. These beds are about 2000 feet in thickness and contain abundant fossils, of which the most noteworthy are the imprints and moulds of numerous fruits of *Williamsonia*, together with fronds and seeds of *Zamites*, *Otozamites*, *Podozamites*, *Pterozamites*, *Ptilophyllum*, and *Dictyozamites*. One *Williamsonia* strobilus with ovulate fruit resembles Buckland's *Podocarya*. A number of buds inclosed in ramentum-covered bracts have also been found. Other important discoveries include small fruits on slender stems, fruits with broad, thin, blade-like bracts, and a staminate disc with small mono-pinnate rachises bearing two lateral rows of synangia. The author believes that we are approaching the solution of the evolution of the Angiosperms. "The primitive semi-Cycadean ancestor, with its crown of reduced, mono-pinnate, spirally inserted microsporophylls," of Arber and Parkin may be supposed to have given rise to the flowers of *Cycadeoïtea*. The present type may be one of several intermediate stages culminating in the gamopetalous Angiosperms. The carpels may be supposed to have evolved in a similar way. The author inclines to the opinion that the petals result from more or less completely sterilised sporophylls. After brief allusions to cruciferous flowers, etc., in support of his theory, the author shows that the form of foliage, stem-structure, etc., offer no obstacles to the connection of the modern angiospermous types with primitive seed-bearing plants. The evidence appears to point to a polyphyletic origin.

Characters of Graft-hybrids.‡—E. Strasburger contributes a paper dealing with the question of graft-hybrids and the causes of the charac-

* Comptes Rendus, cxlix. (1909) pp. 957-61.

† Bot. Gaz., xlviii. (1909) pp. 427-41 (10 figs.).

‡ Ber. Bot. Gesell., xxvii. (1909) pp. 511-28.

ters which they exhibit. After reference to and comment upon the important work upon this subject done by Winkler and Baur, the author describes such a plant which he has had in his possession for some time, and draws conclusions from his observations. The plant in question is a graft-hybrid of an orange and a citron, and the characters of both plants are clearly distinguishable both externally in the foliage, flowers and fruit, and also in the internal structure of vegetative and reproductive tissue. Reference is also made to the graft-hybrid of *Laburnum vulgare* and *L. Adami*. The author has tested the theory enunciated by Beijerinck as to the presence of a specific substance capable of transmission from cell to cell, to which the special characters owe their origin. There appears to be nothing to confirm this theory, but the present work tends to show that the specific individual characters are due to the presence of different nuclei. As in bastards the mingling of characters is due to the mingling of the parental chromosomes in the same nucleus, so in graft-hybrids the distinct characters exhibited by different parts of the plant are due to the presence of different nuclei. According to the character of the nuclei in each individual part of the plant, so will that part develop. Nothing can as yet be stated as to the reason for the varied distribution of the nuclei, but the results of it are most apparent in the generative organs, where it may cause sterility, but on the other hand may be associated with normal fertility.

Hybridisation in *Mirabilis*.*—D. C. E. Marryat has experimented with hybrids of *Mirabilis Jalapa* with special reference to the flower-coloration. Three colour varieties were used, all of which bred true. The most important results of the experiments appear to be the following : A white form, when crossed by yellow, gave a pale-yellow hybrid, thus confirming a prediction made by Correns. This same white form when crossed by crimson had offspring coloured crimson, magenta, orange-red, yellow, or white ; this series of colour is the same as that obtained when any of the other white forms was crossed by yellow, but there is no "flaking" as in the latter case. This same white when crossed by other whites produced coloured forms. Heterozygous forms are always distinct in colour from homozygous forms, and therefore the scheme suggested by Correns needs considerable modification. It does not yet seem possible to regard "flaking" as represented by Mendelian factors.

Inheritance of Flower-colour in *Antirrhinum majus*.†—M. Wheldale has made further investigations as to the flower-colour in *Antirrhinum*, and finds her previous conclusions in respect to Mendelian factors amply verified. The final results are briefly as follows. The flowers of the wild plant are originally magenta, the colour being due to an anthocyanic pigment accompanied by ferments. The pigment itself is an oxidation product. Where the necessary oxydase is not formed the pigment is not produced, and ivory-white flowers are the result. By the loss of another constituent, probably a ferment, yellow is produced. The yellow pigment when oxidised produces crimson. Complete absence of chromogen results in pure white flowers. The absence or presence locally of either oxydase or ferment causes local variation in colour.

* Roy. Soc. Rep. Evol. Comm., v. (1909) pp. 32-50 (2 pls.).

† Tom. cit., pp. 1-25.

Physiological Interpretation of Flower-colour.*—M. Wheldale has tested many colour-varieties of Stocks and Sweet-Peas for oxidases, and finds that all such varieties give strong reaction, either direct or indirect. The results obtained can be explained by the assumption that production of flower-colour is due to the presence of an organic substance of the nature of a peroxide; when the latter is acted upon by peroxidase, nascent oxygen is produced. This nascent oxygen acts upon the chromogen present with the production of an anthocyanic pigment. A ferment is also necessary to reoxidise the original peroxide.

Inheritance of Sex in *Lychnis*.†—G. H. Shull has studied the question of sex in *Lychnis dioica*, and finds that pure-bred families have hermaphrodite mutants, the ratio of mutability being about 1:1000. These hermaphrodites were fully functional males and females and were not diseased; they were of two kinds, some behaving like normal males and others transmitting the hermaphrodite character to the male offspring. The hermaphrodites appear to be modified males, as shown by the offspring produced when they were used as pollen parents. The results agree with those obtained with *Bryonia*, showing the homozygous character of the females and the heterozygous character of the males. These results prove that Strassburger was incorrect in assuming that hermaphrodites were diseased females. The significance of the sex-ratios is not yet understood, and there appears to be a greater variability in sex-ratios than in colour-ratios.

Inheritance of Colour in *Lychnis*.‡—G. H. Shull has also studied colour-inheritance in *Lychnis dioica*, and finds that the purple colour is a compound similar to that found in *Lathyrus*, etc. Two types of colour prevail, one being more red and the other more blue, the former being an acid colour and the latter alkaline. The blue is hypostatic to the red, this being the reverse of what exists in most other plants. It is at present uncertain whether this condition results from positive acidity or alkalinity, or whether only one colour is positive and the other colour is produced when the positive colour is in the heterozygous state. Crosses of white flowered plants often result in progenies of purple-coloured flowers, or of purple and white in the ratios 1:1, 3:5, or 1:3.

CRYPTOGAMS.

Pteridophyta.

(By A. GEPP, M.A. F.L.S.)

Prothallia of *Aneimia* and *Lygodium*.§—E. M. Twiss gives an account of the prothallia of *Aneimia* and *Lygodium*. The spores in each case have three coats; the extine is formed first, and changes later from cellulose to suberin and pectin. The intine is the second coat formed; it remains as a delicate cellulose wall. Thirdly, the episore is formed, arising from the tapetal protoplasm. In the germinating spore the first wall divides the spore contents into two unequal cells, from the

* Roy. Soc. Rep. Evol. Comm., v. (1909) pp. 26-31.

† Bot. Gaz., xlix. (1910) pp. 110-25 (2 figs.).

‡ Amer. Nat., xlv. (1910) pp. 83-91.

§ Bot. Gaz., xlix. (1910) pp. 168-81 (2 pls.).

smaller of which the rhizoid is subsequently produced. In *Lygodium* the apical cell is terminal, appears early, and is persistent; in *Aneimia* it appears later, and is lateral. The lobes of the prothallium are at first unequal. The development of the sexual organs is as in Polypodiaceæ. The first wall of the antheridium is not always flat, but sometimes so concave as almost to touch the basal wall. The number of sperms is large. The archegonia have two neck-canal nuclei. The conclusions are that in the antheridium formation and in the unequal lobing of the prothallium there is nothing to be considered characteristic of the genera. But it may be peculiar to the Schizæaceæ that the rhizoid is not separated off by the first division of the spore. The large number of sperms, the occasional stalk of the antheridium, and the frequent occurrence of two prothallial filaments from the spores, connect the Schizæaceæ with the more primitive families of the Filicineæ.

Monœcious Prothallia in Onoclea.*—E. D. Wuist discusses the physiological conditions for the development of monœcious prothallia in *Onoclea struthiopteris* (said by Campbell to be regularly dioecious), and sums up her results as follows:—Monœcious prothallia, as well as dioecious prothallia, were observed in soil cultures; monœcious prothallia were obtained from "female" prothallia transferred at a ten-celled stage from distilled water to Knop's solution; monœcious prothallia were obtained by transferring "female" prothallia from the soil to a nutritive solution; they were also obtained by transferring prothallia from one nutritive solution to another.

Peculiar Habitat for Camptosorus.†—R. C. Benedict publishes a note on a peculiar habitat for *Camptosorus*, the fern having been found growing epiphytically on the moss-covered trunks of two gum-trees in Virginia, as shown in a photograph. The plant is known as the walking fern, and spreads itself by rooting and budding at the tips of its leaves. It must be very unusual for the plant to grow in such a situation as described.

Interesting Botrychium Habitat.‡—J. H. Schaffner gives a short but interesting account of the finding of a number of sporophytes and gametophytes at a spot in Ohio that has for years been well worked over by botanists. The chance finding of one *Botrychium* led to a careful search being made. Whereupon five species of *Botrychium* and an *Ophioglossum* were found within an area not over two rods square, though these species are supposed to be rare or very rare. Further, several gametophytes were dug up, being detected by means of the tiny juvenile sporophytes projecting above the surface of the ground. It might be expected that the little plantlets would put up a generalised type of first leaf. But as a matter of fact the first leaves were found to be each quite characteristic of its proper species.

New Variety of the Common Ophioglossum.§—E. Ulbrich gives an account of *Ophioglossum vulgatum* var. *Englerianum*, a remarkable new variety from the province of Brandenburg, found by him in a

* Bot. Gaz., xlix. (1910) pp. 216-19.

† Journ. New York Bot. Garden, x. (1909) pp. 13-15 (1 pl.).

‡ Ohio. Nat., x. (1909) pp. 8-9.

§ Fedde's Repertorium, viii. (1910) pp. 49-52.

meadow near Brodowin. It differs from the type by its longer and narrower lanceolate fronds, which do not exceed 2.5 cm. in breadth; the fronds also are cuneate at base and their venation is very narrowly reticulate. He could find no transitional forms to connect it with the type.

New Species of Ceterach.*—J. B. Kümmerle publishes a description of a new species of *Ceterach* (*C. Phillipsianum*) collected by Lort Phillips in Somaliland, and preserved in the British Museum and the Kew Herbarium. Other collectors have brought it from Socotra and Abyssinia. In its geographical distribution it lies between the northern *C. officinarum* and the southern *C. cordatum*. The differences of the three species and of *C. cordatum* var. *capense* are set out in parallel columns in a table.

Italian Ferns.†—M. Lojacono-Pojero gives an account of the Pteridophyta of Sicily—fifty-three species and several varieties with descriptions, synonymy and distribution. Four of the species and some of the varieties are new to science.

S. Sommer.‡ in his Flora of the island of Pianosa, gives a list of nine ferns, with notes on their habitats.

Ferns of New York Botanical Garden.§—G. V. Nash gives an account of the tropical fern collection growing in the New York Botanical Garden, and recently transferred to a new range of conservatories. The tree-ferns and larger species are kept in one house, and the remainder of the collection, arranged in botanical sequence in order to facilitate comparative study, occupies the other houses. Brief notes on the different groups are given.

North American Ferns.||—W. N. Clute writes an obituary notice of James Ansel Graves, one of the founders of the American Fern Society. He also discusses ¶ the climbing fronds of *Lygodium*, with reference to the question whether they should be regarded as leaves of unlimited growth or as branched secondary stem. He also figures and discusses ** an aberrant form of *Lycopodium*, the spikes of which are continued above as simple vegetative shoots. Under the title "Pteridographia" †† he gives a series of notes on such subjects as the gametophytes of *Botrychium*, the Lady Fern, *Botrychium dissectum*, *Asplenium ebenoides*.

E. W. Vickers †† describes some habitats of the inconspicuous *Asplenium pinnatifidum* in a park in Ohio.

S. F. Blake §§ gives a description of *Lycopodium tristachyum* Pursh var. *sharonense*, a new variety found in New Hampshire.

A. Prescott ||| writes of the Lady Fern and its folk-lore.

F. C. Green ¶¶ writes a short note on the ferns of the "bad lands" in Indiana. The only species to be found are *Woodsia obtusa*, *Cystopteris fragilis*, two species of *Equisetum*, and, in stagnant pools, *Marsilia vestita*.

* Bot. Közl., 1909, Heft vi. (1910) pp. 286-90; and Beibl., p. 75.

† Flora Sicula, iii. (1909) pp. 389-411 (1 fig.).

‡ Nuov. Giorn. Bot. Ital., xvii. (1910) pp. 138-40.

§ Journ. New York Bot. Garden, x. (1909) pp. 256-61 (2 pls.).

¶ Fern Bulletin, xviii. (1910) pp. 1-4.

¶¶ Op. cit., pp. 7-9.

†† Tom. cit., pp. 13-19.

** Op. cit., pp. 10-12.

‡‡ Tom. cit., pp. 4-7.

§§ Tom. cit., pp. 9-10.

||| Tom. cit., pp. 12-13.

¶¶ Tom. cit., pp. 16-17.

A. S. Foster* gives a short list of the ferns of Paradise Park, namely, seven species collected in Mount Rainier National Park, Washington.

E. W. Vickers† gives a list of twenty-eight Pteridophytes found in Mahoning County, Ohio, and indeed most of them in Mill Creek Park, which serves almost as an epitome of the county.

Pteridophytes of Ohio.‡—J. H. Schaffner publishes a catalogue of all the sixty-two Pteridophytes known to exist in Ohio, with carefully prepared keys so complete as to enable a student to refer any species to its proper systematic position. For the application of the key to the genera, the specimen must have perfect leaves and petioles and some sporangia; and the vascular bundles should be examined by section at or very near the base of the petiole. A glossary is appended.

Ferns of Costa Rica.§—H. Christ publishes descriptions of seven new species of ferns, and one variety from the collection made in Costa Rica by A. and C. Brade. Costa Rica is one of the richest of the tropical American sources of ferns.

Ferns of Corea and China.—H. Christ|| gives a list of one hundred Pteridophyta collected by Taquet in the Island of Quelpaert during 1908. Two species of *Dryopteris* are described as new to science. He also publishes ¶ a list of seventy-three species collected by Michel in the environs of Gan-Chouen in the province of Kouy-Tchéou. Among these are four new species.

Bryophyta.

(By A. GEPP.)

Development of Air-chambers in Ricciaceæ.**—P. E. Hirsh has studied the origin of the air-chambers in the Ricciaceæ, and gives her results. These confirm the view that there are two methods of origin for the air-chambers. 1. In *Ricciocarpus* and *Ricciella* they arise by internal cleavage of cell-walls, resulting in the formation of broad, polygonal spaces, separated from one another by unilamellate plates of green cells, and provided with stomata in *Ricciocarpus*, but not in *Ricciella*. 2. In *Riccia* proper they are formed by the upward growth of filaments at right angles to the surface of the thallus, and they alternate with them, being in fact long narrow pits.

Apospory and Sexuality in the Mosses.††—Él. and Ém. Marchal have shown in a previous paper that in dioicous mosses the aposporic protonema resulting from the regeneration of the sporophyte produces

* Muhlbergia, v. (1909) p. 144. † Ohio Nat., x. (1910) pp. 86-8.

‡ Proc. Ohio State Acad. Sci., v. (1910) pp. 263-306 (figs.).

§ Fedde's Repertorium, viii. (1910) pp. 17-20.

|| Bull. de l'Acad. Internat. de Géogr. Bot., xix. (1910) pp. 4-11.

¶ Tom. cit., pp. 12-16.

** Bull. Torrey Bot. Club, xxxvii. (1910) pp. 73-7 (figs.).

†† Acad. Roy. de Belg. Bull. Class. Sci., 1909, No. 12, pp. 1249-88. See also Abstract on pp. 1185-6.

plants which present hermaphrodite characters. In the present paper they show that these hermaphrodite products of apospory are absolutely sterile. The reason for this sterility is at present inexplicable. Histological research has given no clue. The authors have also experimented with monoicous mosses, and report that the gonophytes of aposporic origin (they are diploid) are fertile, and the resulting sporophyte is tetraploid. Further, in the tetraploid sporophytes thus formed, sporogenesis produces spores enclosing chromosomes twice as numerous as in normal generation. Finally, on comparing normal gonophytes with diploid and tetraploid gonophytes, it was found that the cells and nuclei of the latter are larger proportionally to the number of their chromosomes.

Proper Value of a Species.*—F. Renaud discusses at some length the notion of the species from the point of view of nomenclature. The species, being one of the bases of nomenclature, ought, so far as is possible, to have a fixed value. Much inconvenience is caused by the admission into systematic botany of species of such different values as emanate from the opposed camps of the “splitters” and “lumpers.” Renaud has himself long oscillated between the two camps during his prolonged study of the polymorphic forms of the European *Harpidia*; during a study of the variations of the North American mosses as compared with European; and when monographing the mosses of the East African islands. He discusses the merits of species in a large sense and in a narrow sense, and shows that in countries where the forms are well-known and can be studied in the living state, the most satisfactory solution is to be found in the employment of subspecies rather than of small species, but that for the flora of a remote region where little is known of the plants, it is better to adopt the system of making provisional species and to note carefully their nearest affinities.

Cohesion-mechanism of Moss-leaves.†—C. Steinbrinck continues his discussion with W. Lorch about the cohesion-mechanism of moss-leaves, and contends that cohesion-mechanism plays the principal part in the distortions which moss-leaves undergo when they become desiccated. He discusses three questions in connection with the cause and manner of these cell-distortions.

British Mosses.‡—The Moss Exchange Club issues its fifteenth annual report containing the customary long lists of exchange-specimens of mosses and hepatics, often with critical notes by one or more members of the Club. The Census Hepatic Catalogue being nearly exhausted, a new and more complete edition is contemplated.

Lancashire Mosses.§—J. A. Wheldon gives an account of a collection of mosses put together by the late F. P. Marrat about sixty years ago. Marrat collected round Liverpool. His specimens are of value as throwing light upon doubtful or obscure records of South Lancashire mosses.

J. A. Wheldon and A. Wilson || record the finding of *Grimmia*

* Journ. de Bot., xxii. (1909) pp. 135-46.

† Ber. Deutsch. Bot. Gesell., xxviii. (1910) pp. 19-30 (figs.).

‡ York: Coultas and Volans, 1910, pp. 329-60.

§ Journ. of Bot., xlviii. (1910) pp. 102-5.

|| Tom. cit., p. 111.

orbicularis Bruch and *Pottia bryooides* Mitt. in the Silverdale district, as new additions to the West Lancashire flora.

Yorkshire Mosses.*—C. A. Cheetham, in his bryological contribution to the forty-eighth annual report of the Yorkshire Naturalists' Union, gives some notes on the more interesting species of mosses and hepatics collected in the county during 1909.

George Stabler (1839-1910).†—A brief obituary notice of George Stabler of Levens, Westmorland, is given. Born at Welburn, near Malton, he became schoolmaster at Levens forty years ago, and is well known as a collector of rare Bryophytes. He became blind a few years before his death.

New Hybrid Moss in Sussex.‡—W. E. Nicholson describes a curious moss which he found fruiting on the coast of Sussex, namely, *Trichostomum flavovirens* fruiting with subcleistocarpons or imperfectly peristomate capsules. Intermixed in the tuft were several plants of *Weisia crispa*; and Nicholson is of opinion that the capsules were the result of hybridisation between the two species. He carefully describes the sporogonia, and points out that this is the third example from the Sussex downs, where the male plant of *Weisia crispa* has formed hybrid capsules with other mosses. In the other instances the female plants were *Weisia crispata* and *W. microstoma*.

Mosses found in Conservatories.§—E. G. Britton gives an account of a rare moss in the conservatories of the New York Botanical Garden, namely, a *Splachnobryum*, probably the same as the species described by H. N. Dixon in 1907. Three times previously have members of the same genus been found in greenhouses. The New York specimen was in fruit, and was growing on a pot of tropical orchids. In a cool palm-house was a fine growth of *Hypopterygium*, and in other houses were found the commoner species *Catharinaea angustata*, *Physcomitrium turbinatum*, *Leptobryum pyriforme*, and the ubiquitous *Marchantia*.

New European Frullania.||—V. Schiffner gives a careful description and figures of *Frullania cleistostoma*, a new species discovered by him on walls at Meran, in Tirol, in 1899, and found again in the same neighbourhood last year by W. Wollny. It belongs to the subgenus *Trachycolea*, and is remarkable as being autoicous. It is allied to *Frullania cesatiuna*, found in the same district. The principal distinctive character of *F. cleistostoma* is the mouth of the perianth, which is blocked by a lining of clavate papillae, which can be seen under the Microscope by transmitted light, and do not necessitate the cutting of sections.

New Species of Anastrophyllum.¶—V. Schiffner gives a descriptive account with figures of *Anastrophyllum Joergensenii*, a new species discovered by E. Jörgensen in Eikefjord, in Western Norway. It is related to *A. Donianum*, with which it is contrasted by the author.

* Naturalist, No. 636 (1910) pp. 62-4.

† Op. cit., No. 637 (1910) p. 97.

‡ Rev. Bryolog., xxxvii. (1910) pp. 23-4.

§ Journ. New York Bot. Garden, x. (1909) pp. 140-1.

|| Oesterr. Bot. Zeit., lix. (1909) pp. 467-72 (figs.).

¶ Hedwigia, xlix. (1910) pp. 396-9 (pl.).

Polytrichaceæ.*—W. Lorch gives a biological account of the Polytrichaceæ, dividing the work into three sections: (1) the gametophyte; (2) the sporophyte; (3) the system of classification and plant geography. He treats the matter in considerable detail. The Polytrichales are the most highly organised mosses, and are not to be separated from the Dawsoniaceæ.

Orthothecium strictum or **O. rubellum**.†—I. Hagen proves by a piece of careful reasoning that the binomial *Orthothecium strictum* has precedence over *O. rubellum*, since (as he shows) *Holmgrenia stricta* Lorentz must have been published at least a few days before *Stereodon rubellus* Mitt.

Notes on Fontinalis.‡—J. Cardot protests against a recent statement by N. C. Kindberg that *Fontinalis maritima* is allied to *F. mollis* and not to *F. neomexicana*. Cardot has examined the original specimens of Carl Müller, and is able to demonstrate that *F. maritima* belongs to a totally different section of the genus from that to which *F. mollis* belongs, and is extremely nearly allied to *F. neomexicana*, being perhaps only a maritime form of it, and found only on the western coast of North America.

Notes on Drepanocladus.§—F. Renauld publishes a second article on the species of *Drepanocladus* (*Harpidium*), based upon specimens contained in the Paris Museum, in F. Camus's herbarium, etc. As even the best descriptions without drawings are insufficient, he is preparing an album of plates showing the principal characters of all the forms described; and this album will be added to his herbarium of *Harpidia* which is already placed in the Paris Museum. In the present article he treats of the European and North American forms of *Drepanocladus aduncus*; ten varieties or forms in group *typicum*, and two in group *Kneiffii*.

Norwegian Mosses.||—H. Winter publishes a general report upon his six bryological journeys in Norway, together with notes on the rarer species collected by him in Germany, Austria, and Switzerland. After giving a geographical sketch of the districts visited, he furnishes a systematic account of the mosses, consisting largely of critical notes upon the various and numerous species. Interspersed are a few new species.

I. Hagen ¶ publishes another part of his preliminary studies of the Norwegian moss-flora, in which he treats of the Splachnaceæ, Oedipodiaceæ, Leucodontaceæ, Ceratodontaceæ, Encalyptaceæ, Seligeraceæ. The text is mainly in Norwegian, but the parts of general interest are in French.

Mosses of Hamburg.**—J. Schmidt publishes some new data about the Hamburg flora, bringing it up to the level of modern efficiency.

* Abh. k. Bayer. Akad. Wiss., 2 Kl., xxiii. (1909) Abt. 3 (65 figs.).

† Rev. Bryolog., xxxvii. (1910) p. 25.

‡ Tom. cit., pp. 45-6.

§ Tom. cit., pp. 29-34.

|| Hedwigia, xlix. (1910) pp. 268-391 (2 pls.).

¶ K. Norsk. Vid. Selsk. Skrift, 1910, No. 1, 1 s pp. (figs.).

** Allgem. Bot. Zeitschr., xvi. (1910) pp. 7-9, 23-5.

He enumerates twenty-six species and several varieties of *Sphagnum*, and eighty-two species and varieties of mosses.

Muscineæ of the Julian Alps.*—J. Glowacki publishes a complete list of the Muscineæ of the Julian Alps, in which he has gathered together all known records, with their exact localities and altitudes. The totals are 110 species of hepaticæ and 459 mosses, with numerous varieties. Two new mosses are described. He has himself made large and frequent collections in the district; and other noted workers have been Sendtner, Breidler, Safer, and, more recently, Loitlesberger.

Italian Muscineæ.†—S. Sommier, in his flora of the Island of Pianosa in the Tyrrhene Sea, gives a list of thirty-six mosses and sixteen hepaticæ determined by A. Bottini and C. Massalongo respectively. The hepaticæ are chiefly of a thalloid character, and among them is *Petalophyllum*.

French Mosses.—C. Meylan ‡ gives an account of *Weisia rutilans* var. *Hillieri* and *Fissidens Monguilloni*, the former a new variety, and the latter a very little known species collected near Besançon by Hillier. A careful description of *Fissidens Monguilloni* by its author and hitherto unpublished is supplied. It had previously been gathered in La Sarthe.

I. Thériot § publishes diagnoses of a new species and five new varieties of mosses from various parts of France.

T. Husnot || records the occurrence at Jurques (Calvados) of *Bryum Mildeanum* Jur. on siliceous ground, and of *Ceratodon purpureus* var. *longifolius*, a new variety.

Mosses of the Pyrenees.¶—G. Dismier gives the results of a few days moss-collecting in the Basque Pyrenees between the following places:—St. Etienne de Baïgorry, Banca, and Les Aldudes, close to the Spanish frontier, and about thirty miles from the Bay of Biscay. He enumerates 127 mosses, 47 hepatics, and 8 Sphagnaceæ; and supplies annotations about the more interesting species, their rarity, distribution, etc.

Muscineæ of Madeira.**—A. Luisier gives a list of eighty-three mosses and seventeen hepatics of Madeira, collected mostly by C. A. Menezes in 1907, and the rest at earlier dates by Johnson, Kny, and Moniz. The points of interests are as follows:—1. The description of three varieties new to science. 2. Records of three genera and eight species or varieties previously unknown in the Atlantic islands, also of five other species not previously known to occur in Madeira. The more critical mosses were submitted to J. Cardot for revision.

North American Bryophyta.—E. G. Britton †† publishes a plea for more and better local work in the mosses. It is lack of careful observation that has led to the long synonymy of such common mosses as *Ceratodon purpureus*, *Ditrichum tortile*, etc. It must be remembered

* Abh. k.k. Zool. Bot. Ges. Wien, v. 2 (1910) 48 pp.

† Nuov. Giorn. Bot. Ital., xvii. (1910) pp. 140-7.

‡ Rev. Bryolog., xxxvii. (1910) pp. 42-4.

§ Tom. cit., pp. 46-8.

|| Tom. cit., pp. 25-6.

¶ Tom. cit., pp. 16-23.

** Brotéria, viii. Bot. (1909) pp. 31-45.

†† Bryologist, xiii. (1910) pp. 30-2.

that some species, when cultivated in vessels in a laboratory, are liable to assume a very different habit, as the result of being confined in a closed damp atmosphere. Herbarium specimens are often old and worn. Yet in *Orthotrichum* and *Grimmia* it is essential that certain fugacious structures, such as peristome-cilia, annulus, calyptra, should be present and in the best condition of maturity.

A. J. Grout* publishes a correction, in which he changes the name *Amblystegium Holzingeri* to *A. americanum*.

A. W. Evans† begins a series of notes on North American hepaticæ, excluding the New England species already discussed in Rhodora. He treats of such species as are interesting by reason of their rarity, their critical character, or their distribution.

A. Lorenz‡ discusses some *Lophozias* of the *Ventricosa* group, viz., *L. longidens*, *L. longiflora*, and *L. confertifolia*, giving figures of their habit and structure, and notes on their distribution and systematic characters.

N. C. Kindberg§ publishes some bryological notes mostly relating to North American mosses, twenty-three collected in the United States by Nelson, and five in Canada by Macoun and Brinkman. A *Rhabdo-weisia*, new to Germany, is recorded for Eisenach; and a new species, *Trichostomum alpinum*, gathered in Colorado by Nelson, is described.

Mexican Mosses.||—J. Cardot continues the publication of his preliminary diagnoses of Mexican mosses, principally collected by Pringle. In the present article are described twenty-five species, six varieties, and the new genus *Platygyriella*, belonging to the family Entodontaceæ, and differing from *Platygyrium* in the structure of its outer peristome.

Moss-flora of the Isle of Pines.¶—E. G. Paris gives a preliminary list of the moss-flora of the Ile des Pins of the New Caledonia group. Madame Le Rat recently spent a month there collecting specimens, and with her husband intends to explore the much bigger neighbouring island with equal care. Paris gives an account of the physical geography of the islands, and enumerates in his list seventy mosses, twenty-one of which are new and will be published with descriptions in a forthcoming memoir by V. F. Brotherus. Eight out of the ten species which were recorded in the Flora Vitiensis as having been gathered in the Isle of Pines by Strange and Milne, are viewed with the strongest suspicion by Paris. Further, a list of twenty-one hepaticæ is furnished by Stephani, and nine of these are new to science.

Chinese Muscineæ.**—E. G. Paris publishes his eleventh article on the Muscineæ of Eastern Asia, and treats of further collections made by the French missionaries Courtois and Henry in the Chinese provinces of Kan Sou and Tche Kiang. He enumerates thirteen mosses, six of which are described as new to science, and two hepatics.

* Bryologist, xiii. (1910) p. 32. † Tom. cit. pp. 33-6.

‡ Tom. cit., pp. 36-45 (3 pls.). § Rev. Bryolog., xxxvi. (1910) pp. 13-15, 44-5.

|| Op. cit., xxxvii. (1910) pp. 4-13.

¶ Tom. cit., pp. 34-42.

** Tom. cit., pp. 1-4.

Thallophyta.

Algæ.

(By MRS. E. S. GEPP.)

British Algæ.*—E. M. Holmes has issued the twelfth fascicle of his *Algæ Britannicæ Rariores Exsiccatæ*, which is to be the concluding one of the series. He also publishes a list of the algæ contained therein, in which a few small errors are corrected, which had appeared in the original issue. Among the algæ represented are *Codium elongatum* from Clare Island, and *Myrionema reptans*, a new species, from Swanage.

Italian Algæ.†—S. Sommier, in his *Flora of the Island of Pianosa in the Tyrrhene Sea*, gives a list of 57 algæ, determined by A. Forti, A. Mazza and Formigginì. They are as follows: 1 Chara, 19 Florideæ, 11 Fucoideæ, 6 Chlorophyceæ, and 20 Heterocontæ and Acontæ.

Marine Algæ of Panama.‡—M. A. Howe publishes a report on a botanical visit to the Isthmus of Panama, in which he records a few interesting notes on the marine algæ which he collected there.

West Indian Marine Algæ.§—M. A. Howe publishes a short report of his work on marine algæ during an expedition to Jamaica, Cuba and the Florida Keys. He was able to enlarge his previous collections to 713 numbers, including about 4000 specimens. One of the most interesting finds was *Bryopsis Duchassaingii* J. Ag., a plant which was re-described by Montagne six years later under the name of *Trichosolen Antillarum*. Hitherto this species has only been known from Guadeloupe, but was found by the author at Port Antonio, Jamaica, as well as at Port Morant. Other interesting records were *Acetabulum polyphysoides* and *Petrosiphon* from Jamaica, *Sarcomenia filamentosa* from Cuba, *Neomeris mucosa*, and species of *Caulerpa*, *Halimeda*, *Acrainvillea*, etc.

Japanese Algæ.||—K. Okamura publishes a further part of his *Icones of Japanese Algæ*, including *Carpopeltis rigida* Schmitz, *C. angusta* Okam., *C. articulata* Okam., *C. elata* Okam., and *Prionitis patens* Okam. The plates are as usual explained in Japanese and English, and a few remarks are added.

Three new Chrysomonads.¶—A. Pascher describes and figures three new species of Chrysomonadeæ, belonging to the genera *Chrysococcus*, *Chromulina* and *Urogenopsis* respectively. All three were found in an old bed of a tributary of the Moldau, in the forest of South Bohemia, near Mugrau. The author considers it probable that the mildness of the climate is specially adapted to the growth of these organisms, and that those already known probably only represent a fraction of the existing species.

Volvocaceæ.**—H. C. Jacobsen has succeeded in cultivating certain of the Volvocaceæ, and describes his experiments in detail. He finds

* Journ. of Bot., xlviii. (1910) p. 109

† Nuov. Giorn. Bot. Ital., xvii. (1910) pp. 147-9.

‡ Journ. New York Bot. Garden, xi. (1910) pp. 20-44.

§ Op. cit., x. (1910) pp. 115-18.

|| Icones of Japanese Algæ, ii. No. 4 (1909) pls. 66-70.

¶ Oesterr. Bot. Zeitschr., lx. (1910) pp. 1-5 (1 pl.).

** Zeitschr. Bot., ii. (1910) pp. 145-88 (1 pl.).

that algal cultures which contain only certain of the Volvocaceæ can be obtained by inoculating decaying albuminous bodies with different materials. The species obtained are *Chlorogonium euchlorum*, certain Chlamydomonads, *Spondylomorom quarternarium*, and *Polytoma uvella*. If these experiments are carried out in the dark, *P. uvella* and sometimes *Chlorogonium euchlorum* are developed. The calcium salts of different organic acids, as well as the organic acids produced by the decomposition of cellulose and pectin, are very suitable for the accumulation of a certain green species of the Volvocaceæ, *Carteria ovata*, here described as a new species. The occurrence of these algæ must be a very common one. They are all very sensitive to acids, but less so to alkalis. By a slight deficiency of oxygen they produce through carbonic-acid assimilation a great quantity of oxygen, and by this means they promote powerfully the cleansing of dirty water. The cultivated Volvocaceæ show, with the exception of *Polytoma uvella*, a strong sensitiveness to light, and re-act positively as well as negatively phototactically, according to the intensity of light and to their reaction to light, this last being influenced by different factors. By means of this phototactic quality, and their different behaviour in drying, it is possible to divide the species from each other to a certain extent and to purify from bacteria. Pure cultures can be obtained of most of them by the usual bacteriological methods, since they form colonies on firm nutritive substrata. The decomposition products of albumen have the greatest significance for the organic nutrition of these organisms, through the action of trypsin; for *Carteria ovata* the organic calcium salts are sufficient. The above-mentioned algæ belong, with the exception of *Polytoma uvella*, which is purely saprophytic, to the decidedly myxotrophic organisms.

Serbian Desmids.*—P. Georgevitch gives a list of 199 species, belonging to nineteen genera, which were collected by himself and his brother in the months of June and August in moorland lakes above Wlasina in Serbia. These lakes lie on a plateau 1219 metres above sea-level, called the Wlasina-See. Up to the present time only ten genera with sixteen species had been recorded for Serbia, so the present list greatly enlarges the known desmid flora for that region. One new variety, *Cosmarium calatum* Ralfs var. *coronatum*, is described and figured.

Desmids from Macedonia.†—P. Georgevitch enumerates 123 species of desmids from the Prespasee in Macedonia. One or two short critical notes are added.

Catalogue of Portuguese Diatoms.‡—C. Zimmermann publishes a list of the species of Portuguese diatoms, which he issues in his second and third centuries, and adds localities to each record. Almost all the species enumerated are new to Portugal.

Diatoms of Madeira and Porto Santo.§—C. Zimmermann records 115 species of diatoms from Madeira and Porto Santo, from which localities only three species have as yet been made known. He gives a

* Beih. Bot. Centralbl., xxvi. (1910) pp. 189–204 (2 pls.).

† Tom. cit., pp. 237–46 (figs.).

‡ Brotéria, viii. (1909) pp. 89–103.

§ Tom. cit., pp. 114–27 (1 pl.).

new description of *Achnanthes inflata* Grun., and figures it; hitherto there has been no proper definition of its characteristics. A new variety, var. *madeiraensis*, is described for *Aulacodiscus amœnus* Grev.

Vaucheria synandra.*—P. E. Kaiser records for the first time an instance of *Vaucheria synandra* growing inland, far from the sea. It appears to flourish and fruit in a ditch near the brine baths at Elmen, near Magdeburg in Germany, together with *V. dichotoma*. *V. synandra* showed the characteristic antheridia and oogonia. The locality in which it was growing was saturated with brine and other well-known halophytic algae, and diatoms were found there. The author believes that *V. Thuretii* was also growing in the same place, but is unable to confirm absolutely the belief, since the actual spot where that species was found has since been interfered with.

Saccorhiza bulbosa.†—F. Tobler publishes a few remarks on this alga, of which he has studied many examples, both fresh and in herbaria. He draws up a comparative table of seventeen specimens, giving the length of the frond, development of the organ of attachment, length of stem, etc. He states that the length of the stem has no connection with the depth of the habitat, and that when the stem has reached a certain degree of development, the peculiar frilled growth is discontinued.

Zoning of Brown Seaweeds.‡—S. M. Baker has continued her investigations into the causes of the zoning of brown seaweeds on the sea-shore. The experiments described in the present paper were carried out with a view to determining the influence of periodic desiccation on the germination, and also on the dehiscence-mechanism of the four species under observation—namely, *Fucus platycarpus*, *Ascophyllum nodosum*, *Fucus vesiculosus*, and *F. serratus*. The four species grow in this order from the high-water line downwards. The author finds that those algae which grow in the upper zones are capable of resisting desiccation both during germination and vegetative growth. Also their receptacles are protected by being filled with mucilage, and this seems to make their dehiscence-mechanism most efficient when they are dry for a considerable length of time. Also, in both *F. spiralis* and *Ascophyllum nodosum* the paraphyses project considerably from the ostioles of the conceptacles; and this may be an adaptation to ensure the gametes being very rapidly expelled during the short time they are covered by water. Experiments with *F. spiralis* point to this conclusion.

The algae growing in the lower zones have become adapted to very rapid growth; they are thus able to supersede the more slow-growing and protected forms, in their own zones, but at the same time they have not the power of resisting desiccation, so that they cannot grow in the upper zones. Also their dehiscence-mechanism has become efficient for very short times of exposure; and they are able to choke out any stray member of a higher zone, growing lower down, which cannot compete with them in the number of reproductive bodies given off.

* Hedwigia, xlix. (1910) pp. 400-2.

† Kong. Norsk. Vidensk. Selsk. Skrift., No. 6 (1908) 9 pp. (1 pl.).

‡ New Phytologist, ix. (1910) pp. 54-67.

Tænioma.*—E. I. Thompson gives an account of the morphology of *Tænioma macrourum* Thuret. She describes shortly the external appearance, and then deals with the growth and development of the vegetative plant. So far, the only known organs of reproduction of this genus have been the tetraspores, but the author here describes the antheridia and cystocarps in detail. In her opinion, the structure of the cystocarps is such as to warrant the removal of the genus from Delesseriaceæ, where it has hitherto been placed, into Rhodomelaceæ.

Polymorphism of Algæ.†—R. Chodat publishes a book on this subject, which he calls "A Critical and Experimental Study on the Polymorphism of Algæ." In the first chapter he treats very fully of the meaning he attaches to the word polymorphism, and of the views held by other botanists. He then describes his methods of work, and in the second chapter deals with many instances of polymorphism proved by himself. Other points in connection with polymorphism are then discussed, and are followed by a short summary, in which the author states his conviction that there are certainly algæ which, by their extreme variability, merit the title of polymorphous, if by that term it be understood that a plant can present itself under several aspects without changing its nature. The polymorphism of algæ is of the same order as that of many other plants; some are more plastic than others. But in a general sense the author does not admit the thesis formulated by Hansgirg in his memoir, which is here criticised in detail. Experiments tend to show that while there are certain algæ which are polymorphous, there are others which show a remarkable stability. Finally, the author protests against the general use of the term "theory of polymorphism."

KLINGSTEDT, F. W.—Über den Einfluss farbigen Lichtes auf die Färbung lebender Oscillarien. (On the influence of coloured light on the coloration of living Oscillariæ.)

Öfv. Finsk. Vetensk.-Soc. Förrhandl., li. (1909) No. 1.
See also *Bot. Zeit.*, lxxviii. (1910) p. 51.

Fungi.

(BY A. LORRAIN SMITH, F.L.S.)

Experiments with Mucorini.‡—L. Raybaud tested the influence of sudden illumination on the mycelium of Mucorini, and found that a quick movement of the protoplasm followed the light; a change to the dark causes the protoplasm to retreat, and these changes are indicated by swellings and lines on the hyphæ. In a second experiment he tested the results of osmotic pressure; mycelium was grown in a concentrated drop of orange juice, surrounded by a circle of water tinted with methyl blue; as soon as the hyphæ reached the latter liquid, swellings were formed which often burst, especially in *Phycomyces nitens*.

He also applied atmospheric tests, and found that, whereas in a moist atmosphere all the spores were about equal, in a dry air they varied in size and form, and were sometimes covered with granulations.

* Bull. Torrey Bot. Club, xxxvii. (1910) pp. 97–106 (2 pls.).

† Étude critique et expérimentale sur le Polymorphisme des Algues. Genève: Georg et Cie. (1909) 167 pp. (21 pls.).

‡ C.R. Soc. Biol. Paris, lxxvi. (1909) pp. 887–9, 1118–21.

Urophlyctis Alfalfæ.*—Korff has written an account of this fungus, which lives on the roots of *Alfalfa*, and forms outgrowths very similar to those caused by *Chrysophlyctis endobiotica* on potatoes, and reaching the dimensions of a nut or of a fist. *Urophlyctis* is one of the Chytridinea, and was first described by Magnus. It does not seem to harm the *Alfalfa*, as the plants with swellings on their roots were always the biggest and healthiest-looking.

Development of *Helvella elastica*.†—W. A. McCubbin gives a sketch of work done on the group of Discomycetes to which *Helvella* belongs, and then describes his own material and methods. The mycelium of the fungus is subterranean: the young stages were taken from a bank of loose damp sand in High Park, Toronto. The author found in the mycelial tissues certain large irregular cells, which were apparently storage-cells. The ascogenous hyphæ arise as a subhymenial complex of filaments, and from this layer arise vertical hyphæ, of which the end cells contain two nuclei. Hooks are formed by these end cells, the penultimate cell being two-nucleate, and either forming the ascus or giving rise to a second hook (as many as six hooks may thus arise from successive penultimate hooked cells). The terminal and antepenultimate cells are uninucleate, but often they fuse and give rise to a filament which also forms a hook. No structure having the conventional form of an ascogonium was found.

Systematic Position of *Urnula Geaster*.‡—This species was named and described by Peck from dried material. F. D. Heald and F. A. Wolf have recently secured living specimens that enabled Peck to supplement and complete his previous diagnosis. It had, meanwhile, been made the type of a new genus, *Choriactis*, on account of the supposed parenchymatous wall of the apothecium. The authors show that the wall is made up of interlaced hyphæ with large intercellular spaces, and the species is a true *Urnula*.

***Xylaria Hypoxylon*.**§—E. Harder has studied the relation of *Xylaria Hypoxylon* to the wood on which it grows. He grew it on pine cultures, and gives his observations. *Xylaria* hyphæ never impart a dark colour to the wood: it is either white or clear brown; the dark colour so often present is due to some other fungus. The *Xylaria* hyphæ, which may be parasitic, are colourless, thin, and full of plasma at the early stages; later, they become thick-walled and empty. A second form of mycelium, which is brown coloured, may be considered a kind of resting form. *Xylaria* mycelium can resist drought, but for good development great humidity is necessary. Beech-wood is the best substratum for the fungus; pine-wood the least advantageous.

American *Hypocreales* iii.||—F. J. Seaver continues his monograph of this group. He divides Hypocreaceæ into two families, Hypocreæ

* Prakt. Bl. Pflanzensch. Pflanzenb., vii., No. 12 (1909). See also Centralbl. Bakt., xxvi. (1910) pp. 563-4.

† Bot. Gaz., xlix. (1910) pp. 195-206 (3 pls.).

‡ Tom. cit., pp. 182-8 (1 pl. and 3 figs.).

§ Oesterr. Bot. Zeitschr., lix. (1909) pp. 275-9, 299-302. See also Bot. Centralbl., cxiii. (1910) pp. 172-3.

|| Mycologia, ii. (1910) pp. 48-92 (2 pls.).

and Cordyceptæ. In the present issue he deals only with the first. To the genera already known he adds two: *Chromocrea*, with brown spores, each of which divides into two sub-globose cells, thus presenting a sixteen-spored ascus, and *Chromocreopsis*, also with dark-coloured spores, but, whether simple or septate, always persisting as eight spores in the ascus. For the genus *Epichloe* has been substituted the older generic name *Typhodium* of Link.

Study of Chætomium.*—G. Bainier has made a renewed examination of *Chætomium* and of some of the neighbouring genera. One of the species, *C. pineti* described by Fuckel, has a small globose fruit without any ostiole, which brings it within the definition of Perisporiaceæ. Bainier, therefore, classifies it under Zopf's genus *Chætomidium*. He also describes two new species, *Chætomidium magnum* found on dog's dung, and *C. phyllactineum* which grew on rotten paper. He re-describes and figures *Magnusia nitida*, and then passes on to *Chætomium*. He finds the hairs that grow on the exterior of the perithecium a distinguishing specific character. The genus has been somewhat imperfectly described hitherto; now Bainier has made a thorough study of it, and gives descriptions and figures of many new forms. A key to the species is added at the end of the paper.

Cytology of Yeasts.†—A. Guilliermond criticises a recent paper on this subject published by Peniston and Wager. These authors maintained that the vacuole of the yeast-cell and the small body adhering to it constitute the nucleus. Guilliermond denies the correctness of this view; the vacuole, he holds, is a secretory structure, since it is coloured while still living by neutral red; and the body, which Peniston and Wager call a nucleolus, he regards as a nucleus. He finds that this nucleus, when properly fixed and stained, shows a nuclear structure, nucleolus and membrane. After fusion to form the ascus, it is larger in size, and mitotic division can be observed in it.

Development of Lasiodiplodia Fiorii sp. n.‡—P. Baccarini describes this fungus which was found on a branch of *Modceca abyssinica*. It is a member of the Sphærospideæ, and forms a stroma or pseudostroma on which are developed the pycnidia. No other fruiting condition has been found, and it may be a reduced form with only one type of fructification. Baccarini made cultures of spores and mycelium, and he follows in great detail the germination of the spores, the anastomosing of the hyphæ, and the formation of the stroma and pycnidia. He found no trace of any fusion that might be considered of a sexual nature, and he did not consider that the anastomosis of the hyphæ had any connection with spore formation. He describes two forms of pycnidial growth, the one formed at the surface of the culture, the other formed deeper down: but there was substantial agreement between the two forms.

Classification of Hyphomycetes.§—P. Vuillemin does not find the accepted method of classification sufficient, as similar or nearly allied

* Bull. Soc. Mycol. France, xxv. (1910) pp. 191-237 (17 pls.).

† Comptes Rendus, cl. (1910) pp. 835-8.

‡ Nuov. Giorn. Bot. Ital., xvii. (1910) pp. 165-91 (17 figs.).

§ Comptes Rendus, cl. (1910) pp. 882-3.

forms may at different stages be arranged under widely separated genera. He finds the conidia the most stable element; after that the stalk-cell or basidium, which immediately bears the conidia; for this organ he proposes the term "phialide," and the branches bearing these he regards as "phialophores." All the genera and species with a distinct phialide he classifies in the Phialideæ. As type of the family he describes *Urophiala mycophila* g. et sp. n., in which the branch or phialophore gives rise to a prophialide from the penultimate cell; this cell produces three phialides, each one bearing at the tip a colourless unicellular spore.

Hyphomycetes.*—G. Liudau has completed the main body of the work on moulds, and the last issue deals with a series of doubtful genera, such as *Rhizomorpha*, *Anthina*, *Ozonium*, etc. He also adds an appendix in which he corrects some errors of the previous fascicles, and records genera and species described since the publication of previous parts. The illustrations are numerous and instructive.

Black Spot in Cheese.†—R. Burri and W. Staub investigated the cause of blackening of Emmentaler cheese. The rind was especially affected during storage in the cellar. The fungus is midway between a Yeast and a Hyphomycete. Conidial formation was not seen, but from physiological as well as morphological characters the authors have named it *Monilia nigra* sp. n.

Uredineæ.‡—W. Tranzschel has made a special study of autoecious *Uromyces* on *Euphorbia* in connection with Sydow's monograph of Uredineæ. Only a few species had been described, but these included so many variations in development and spore form that he began to examine the nature of these so-called species, and found, as he suspected, that each one really included several, all quite distinct from each other. He distinguishes two main groups of *Uromyces* on *Euphorbia*: those in which uredo- and telentospore sori arise on localised mycelium, while the æcidia arise on the diffuse mycelium of a whole shoot; and, secondly, those in which telentospores arise over a whole shoot. On many of the latter there are also æcidia, but it is not certain if they belong to the same life-cycle. Numerous notes are given, and a full account of all the twenty-seven species.

Notes on the Larger Fungi.§—Ferdinand Guéguen found specimens of *Volvaria murinella* on a pine cone which was still green, and he argues that the fungus is a true parasite, as the mycelium must have penetrated the tissues while they were still living.

An account|| of three edible mushrooms, *Agaricus campestris*, *A. arvensis*, and *A. elvensis*, is published by the Board of Agriculture. Short descriptive notes are given to enable the amateur to distinguish them from other Agarics. Each one is also represented by a coloured plate.

* Rabenhorst's Kryptogamen-Flora, abt. 9, lief. 116 (Leipzig, 1910) pp. 689-752.

† Landw. Jahrb. Schweiz., 1909, p. 487. See also Ann. Mycol., viii. (1910) p. 110.

‡ Ann. Mycol., viii. (1910) pp. 1-35.

§ Bull. Soc. Mycol. France, xxv. (1910) pp. 243-4.

|| Journ. Board Agric., xvi. (1910) pp. 919-21 (3 pls.).

Coloured plates and descriptions* of three species, *Agaricus hæmorrhoidarius*, *Coprinus comatus*, and *Amanita rubescens*, have been published in a later paper. Special note is made of their gastronomic qualities: all of them are edible.

E. Münch † examined into the causes that induce etiolation in the stalk of *Collybia velutipes*. He found that normal fruit-bodies require full daylight for their development. In artificially darkened cultures or in plants developed in the shade, under roots, etc., there is considerable prolongation of stem. The hymenium is only developed under the influence of light. The spores germinate at a low temperature. Münch observed *Oidium* formation, but did not consider the *Oidia* as important reproductive bodies.

E. T. Butler ‡ writes on *Fomes lucidus* as a suspected parasite. He cites a number of cases in which there is reason to believe that it has caused the death of trees in India.

Merulius lacrymans. §—J. Beauverie has published a study of the mycelium of this fungus as a contribution to our knowledge of the organisms that are so destructive to the woodwork of houses. He has sought to emphasize the difference between this and other similar destructive fungi, such as *Poria vaporaria*, *Lenzites sepiaria*, etc. A first point of distinction is in the formation of clamp connections which are common to many Basidiomycetes, but in *Merulius* form the starting-point of a lateral branch. Another distinguishing character is the formation of mycelial strands on cords consisting of three elements: (1) filaments with dense protoplasmic contents; (2) filaments with stronger walls and larger lumen, but with scarcely any protoplasmic contents; (3) long filaments that thin out at the tips and bend back, forming a crook. The large filaments are comparable to the vessels of the higher plants, the narrower elements to the fibres, and the hyphæ with protoplasmic contents to the parenchyma. Two nuclei were present in all the cells; metachromatic corpuscles were constantly observed; glycogen was also present, especially in the spores.

Experiments on Higher Fungi. ||—E. Wakefield sowed spores of *Schizophyllum commune* and *Stereum purpureum* on gelatin and on bread, and cultivated both sterile and fertile plants. He concludes that there is a tendency from the spore onwards towards the production of one or the other condition which may also occur in nature. The tendency to fruit-formation may be retarded by change or by weakening of the culture-medium. On a very thin substratum only the beginnings of fruit-formation were noted. *Schizophyllum* does not develop normally unless there is all-round illumination. Moisture induces over-development of mycelium and no fruit-bodies are formed, nor are they formed in too dry conditions.

* Journ. Board Agric., xvi. (1910) pp. 1009-10.

† Natur. Zeitschr. Forst.-Landw., vii. No. 12 (1909). See also Centralbl. Bakt., xxvi. (1910) pp. 566-7.

‡ Indian Forestry, xxxv. (1909) pp. 514-18. See also Bot. Centralbl., cxiii. (1910) p. 331.

§ Rev. Gén. Bot., xx. (1909) pp. 449-69 (53 figs.).

|| Naturw. Zeitschr. Forst.-Landw., vii. No. 11 (1909). See also Centralbl. Bakt., xxvi. (1910) pp. 565-6.

Italian Cryptogamic Flora.*—T. Ferraris has recently issued the sixth fascicle of this work dealing with the Hyphomycetes. The author begins with the more complicated members of the group, the Tuberculariaceæ and Stilbaceæ, and completes the examination of their families. He prefaces the part with a discussion as to the systematic position and economic importance of the Hyphomycetes, and gives advice to beginners how to collect and examine these minute plants. The genera are illustrated.

Protection of Shade Trees against Attacks of Fungi.†—W. A. Merrill delivered a lecture on this subject in New York. He describes the fungi that particularly attack the shady parts of trees—*Polyporei*, etc. Their spores gain entrance to the tissues through wounds, and his advice was to avoid leaving any exposed tissue unprotected. The cut surfaces laid bare by pruning are a special danger, and he gave instructions as to pruning and to treating the wounds.

Mycological Notes, No. 34.‡—C. G. Lloyd includes in the last issue of these photographs and notes on *Clathrus cibarius*, *Claustriavia merulina*, *Simblum periphragmoides*, *Bovistella echinella*, *B. pusilla*, and *Pseudocolus javanicus*. The author also publishes descriptions of various species that he has found in herbaria or merely recorded in books.

Fermentation Fungi from Korea.§—K. Saito has studied the organisms used in Korea for the preparation of koji, and found *Aspergillus glaucus*, *Penicillium glaucum*, *Monascus purpureus*, *Mucor circinelloides*, *M. plumbeus*, *Absidia* sp., *Sachsia* sp., and even more frequently *Aspergillus Oryzæ*, *Rhizopus Tritici*, and *R. Tamari*, the latter particularly effective in the saccharification of starch. In different kinds of maize numerous yeasts and bacteria were met with; a new yeast, *Saccharomyces corea*, was isolated.

Fungi of Termites' Nests.||—Henri Jumelle and H. Perrier de la Bâthie have written an account of termites' nests, and of the fungi cultivated by the ants in Madagascar. There are several species inhabiting the woods, hills, or trees, but the authors confine their study to one species, *Termes Perrieri*, the sylvicolous form. The nests are made from earth collected in the forest, are over 1 m. in height, and are conical in form; inside they are divided into chambers. Round the ant-hill there is a network of subterranean galleries, by which the ants go to obtain the wood, which they convert by mastication into a kind of cake. These cakes form the substratum of the fungus, and the combined cake and fungus provide food for the adult ants. The larvæ eat the small tufts of conidial fructifications that develop on the cakes. The authors describe their experiments with the feeding of ants and larvæ, and they discuss the identification of the fungus, which they consider to be a *Xylaria*. They compare their observations with those of T. Petch on the same subject in Ceylon.

* Soc. Bot. Ital., Flora Italica Cryptogamica, i. No. 6 (1910) 194 pp. (53 figs.).

† Journ. New York Bot. Gard., x. (1909) pp. 193-205 (1 pl. and 6 figs.).

‡ Cincinnati, 1910, pp. 446-60 (9 figs.).

§ Bot. Mag. Tokyo, xxiii. (1909) pp. 97-8.

|| Rev. Gén. Bot., xxii. (1910) pp. 30-64 (9 figs.).

Wintering of Fungus Spores.*—The capacity of summer conidia to withstand cold has been tested by Ewert in a series of experiments with the pycnidial spores of *Mycosphærella sentina* and the conidia of *Fusicladium piriinum* and *F. dendriticum*. He exposed the spores and conidia to repeated frost temperatures, and thus tested their germinating capacity and their power to infect the host-plant. In both species the fungi retained their vitality, thus enormously increasing the risks of infection, as in cases where the ascus fruit had not been formed, the summer fruit would carry on the life of the fungus. The writer considers that his results have considerable bearing on Eriksson's mycoplasma theory.

Poisonous Fungi.†—Ed. Butignot records cases of poisoning in the Bernese Jura due to eating *Entoloma lividum*. Four small specimens of the fungus were mixed with other species to form a dish for the evening meal which was eaten by five people, all of whom suffered more or less severely, though none of the cases were fatal.

A. Sartory‡ gives his experiences of *Cantharellus tubæformis* and *C. aurantiacus*, both of which have been classed among poisonous forms. These fungi were given to guinea-pigs to eat and the sap was injected without any appreciable harm. Sartory concludes that they are non-poisonous.

Contribution to the Micro-fungus Flora of Central Russia.§—A. Potebnia has made a study by culture and prolonged observation of species of micro-fungi, his aim being chiefly to arrive at a knowledge of parasitic forms and to connect up the lower conidial and pycnidial forms with the higher ascus-bearing species. He gives a list of Ustilagineæ and Uredinæ observed by him in the district (Gouv. Kursk and Charkow) as well as of other micro-fungi, and then proceeds to the more detailed examination of certain groups and species. He established *Mycosphærella Ægopodii* as the ultimate fruiting form of the sclerotium on *Ægopodium* leaves, previously considered by him to be *Phyllachora Podagrariæ*. He also proved the connection between other species of *Mycosphærella* and pycnidial forms. *Glaeosporium Robergei* was found to be a stage of *Sphærognomonium carpinea* g. n., a parasite on the leaves of *Carpinus Betulus*. Special notes are given on Sphæröpsidales, especially of the genera *Septoria* and *Phleospora*. He records in all 300 species.

Argentine Fungi.||—C. Spegazzini has issued Series IV. of his *Mycetes Argentinenses*. It includes 612 species, many of them new to science, and the following new genera: *Micromastia*, related to *Anizia*, but with different spores; *Paracapnodium* (Capnodiaceæ), with colourless septate spores; *Phæophomatospora*, differs from *Phomatospora* in having coloured spores; *Pseudodiaporthe*, differs from *Diaporthe* in the form of paraphyses; *Oraniella*, with immersed perithecia and colourless septate

* Zeitschr. Pflanzenkr., xx. (1910) pp. 129-41 (2 figs.).

† Bull. Soc. Mycol. France, xx. (1910) pp. 250-2.

‡ Tom. cit., pp. 253-4. § Ann. Mycol., viii. (1910) pp. 42-93 (38 figs.).

|| Anales Mus. Nac. Buenos Aires, xix. (1909) pp. 257-458 (40 figs.). See also Ann. Mycol., viii. (1910) p. 105.

spores; *Venturiella*, related to *Venturia*, but with brown septate spores; *Leucothyridium*, with a spreading stroma and muriform colourless spores; *Pleomeclogramma*, differs from the previous genus in the want of paraphyses; *Copranophilus*, near to *Treleasia*, spores lanceolate, one septate; *Calyptronectria*, near to *Hyponectria*, but with muriform spores; *Dothi-drovalsa* (Dothideaceæ), with small colourless bent spores; *Coscinopeltis*, similar to *Polystomella*, but with simple colourless spores.

French Fungus Flora.*—R. Bigeard and H. Guillemin have published a Flora of the larger fungi with descriptions of the more important fleshy forms of Agarics, Boletes, Polypores, etc. They have omitted any account of the smaller species, reserving a discussion of them and of the rarer species for a supplementary volume. Large use has been made of keys to genera and species. E. Boudier has written a preface to the volume.

Pathogenic Fungi.†—Louis Matruchot has identified a fungus causing tumours under the human skin as *Sporotrichum Beurmanni*. Two other species, *S. Schencki* and *S. Gougeroti*, have also been isolated and examined; the former was taken from an abscess, the latter was found in the muscles of the leg of an invalid, and was specially characterized by its *Torula* production. The three fungi are closely related morphologically, and form a small natural group.

Plant Diseases.—Griffon and Maublanc‡ record several parasites on hot-house plants: *Pestalozzia Clusiæ* sp. n., which forms spots on leaves of *Clusia*, and *Phyllosticta Dracenzæ* sp. n., which also attacks the foliage of the host. They also examined a *Gleosporium* parasitic on *Codiaeum* leaves, and find that two previously described forms, *Gleosporium Sorauerianum* and *G. Crotonis*, are identical with the one found by them. They retain the first name, as the older. On the spots formed by the *Gleosporium* they found *Asteroma Codiaei*. They suggest that it may be saprophytic on the destroyed tissue.

An enquiry§ has been made as to the distribution of wart disease of potatoes in Great Britain. It is largely confined to North Central England, North Wales, and Central Scotland. There are still large districts where the disease is unknown, and growers in these districts are warned to be careful in their choice of seed potatoes, and not to manure with rotten potatoes.

G. Masee|| has described a disease of cucumber and tomato plants due to a minute fungus, *Mycosphærella citrullina*. The nodes of the stem are attacked, the diseased patches becoming whitish, or of an ashy-grey colour, and studded with the perithecia of the fungus. Only the pycnidial form of the fungus—a form of *Ascochyta*—was found on the diseased plants. Experiments at Kew proved that spores taken from cucumber plants infected tomato plants, and those from the tomato were

* Flore des Champignons supérieurs de France les plus importants à connaître. Chalons-sur-Saône, 1909, 600 pp. (56 pls.). See also Bull. Soc. Mycol. France, xxv. (1910) pp. 254-6.

† Comptes Rendus, cl. (1910) pp. 543-5.

‡ Bull. Soc. Mycol. France, xxv. (1910) pp. 233-42 (1 pl.).

§ Journ. Board. Agric., xvi. (1910) pp. 923-4.

|| Kew Bulletin, 1909, pp. 292-3 (1 pl.).

employed to infect successfully vegetable marrow plants. In both instances the *Ascochyta* was reproduced within a fortnight.

J. G. Groszenbacher* first detected this disease in hothouses at Geneva (New York), where it was found destroying the stalks of cucumber. He made numerous successful culture experiments.

A series of observations† on *Chrysophlyctis endobiotica* have been made by Georg Schneider. The disease was not affected by changes of soil; the warts appear on young stages of the tubers, causing the eyes to develop abnormally and form the canker-like outgrowths; parts of the stem above ground and the leaves were attacked and deformed as well as tubers and rhizomes. The disease has not attained serious dimensions on the Continent, and advice is given as to stamping it out.

W. W. Gilbert‡ has studied a root-rot of tobacco caused by the fungus *Thielavia basicola*. It causes the dwarfing and death of the plants in the seed-bed and in the field. The conditions favourable to the spread of the disease are (1) a heavy soil rich in humus; (2) excessive manuring; (3) heavy watering and lack of ventilation in the beds.

Fr. Bubak§ describes a disease of lucerne (*Medicago sativa*) in Austria due to an Ascomycete, *Pleosphaerulina Briosiana*. The disease was very evident, almost every leaf showing one or more of the black patches on which the fungus grew. The perithecia are deep-seated in the tissue of the leaf, and are visible as minute protuberances. Bubak gives a complete account of the fungus. Along with the ascus form a pycnidial stage, *Ascochyta Medicaginis*, is constantly present, and the two forms are probably connected in the same life-history.

Haven Metcalf and J. Franklin Collins|| have issued a bulletin on "the present status of the Chestnut Bark Disease." It is caused by a minute fungus *Diaporthe parasitica*, also known as *Valsonectria parasitica*, and occurs on chestnut and chinquapin regardless of age, origin, or condition. It exterminates the trees in any locality which it infests. In Forest Park, Brooklyn, in an area of 350 acres, 16,695 trees were killed. The spores of the fungus enter the bark by a wound or possibly also in other ways; the leaves and green twigs are not directly affected. The mycelium spreads in the inner bark until the tree is girdled; if the first attack is on the trunk, the tree dies; if the branches are first infected, the tree will live for some time. Cutting out and destroying all diseased bark and limbs should be attended to, so as to stamp out the disease as soon as it appears.

T. Petch¶ gives an account of the depredations caused on the rubber tree, *Hevea brasiliensis*, and on tea, by the fungus *Corticium javanicum*. It appears as an incrustation of a pink colour on the bark, and is locally known as "pink disease." Close planting favours the growth of

* New York Agric. Exper. Stat. Tech. Bull. 9 (1909) pp. 195-229 (9 pls.). See also Centralbl. Bakt., xxvi. (1910) p. 292.

† Deutsch. Landw. Presse, xxxvi. (1909) p. 340. See also Centralbl. Bakt., xxvi. (1910) pp. 300-1.

‡ U.S. Bureau, Plant Industry, Bull. 158 (1909). See also Bot. Centralbl., exxiii. (1909) pp. 199-200.

§ Wiener Landw. Zeit., lix. (1909) p. 909. See also Centralbl. Bakt., xxvi. (1910) pp. 301-2.

|| U.S. Dept. Agric., Bull. No. 141, pt. 5 (1909) pp. 45-53 (3 figs.).

¶ Circ. and Agric. Journ. Roy. Bot. Gard. Ceylon, iv. No. 21 (1909) pp. 189-96.

the fungus by affording suitable conditions for the germination of the spores. It also grows in the jungle on bushes of various kinds.

In a more recent paper* Petch describes another disease of *Hevea*, called "die-back." The fungus which begins the disease is *Glaeosporium alborubrum* Petch, and it attacks the young shoots. The further stage of the die-back is a wound parasite *Botryodiplodia elasticæ*; it does not enter the tree until the top-shoots have been killed by the *Glaeosporium*, but it does far more damage. When trees are attacked, the diseased tops should be at once cut off and burnt, and the cut surface tarred.

The stem-bleeding disease of the coconut † has also been investigated by Petch. He found that it was due to a fungus, *Thielaviopsis ethacetica*, which causes the bark to split, and from the wounds thus made the sap flows out. The progress of the disease is very slow, and the tree is gradually hollowed out by the action of the fungus. Petch recommends cutting out the diseased patches and tarring the wound.

A disease broke out in a field of celery ‡ in Sussex in 1909 and caused considerable loss: it was caused by a fungus *Phyllosticta Apii*; the black perithecia containing countless minute spores are produced on blackened spots of the leaves. The disease spreads with great rapidity in damp dull weather. A second disease caused by an allied fungus, *Septoria Petroselini*, has been known for some time. The leaf spots are smaller, and the spores needle-shaped. The latter disease also spreads with great rapidity. The same preventive measures are recommended for both, viz., spraying with half-strength Bordeaux mixture.

Brown rot of tomatoes § has also been dealt with by the Board of Agriculture. The fruit only is attacked: it shows discoloured patches, and the skin and the pulp become reduced to a dark-coloured mass; the seeds are also brown in colour, and contain fungal hyphæ which resemble the hyphæ of *Phytophthora omnivora*. The brown seeds germinate, and are reported to produce plants which bear infected fruits.

F. J. Seaver || publishes a popular account of plant diseases in a lecture delivered by him in New York Botanical Gardens. Most of the diseases treated are due to fungal parasites belonging to Ustilagineæ, Uredineæ, and Ascomycetes. He also touches on gall-formation by insects, and on the harm done to cultivated plants by dodder.

BACHMAN, FRIDA M.—Discomycetes in the Vicinity of Oxford, Ohio.

Proc. Ohio State Acad. Sci., v. No. 2 (1909) pp. 19-70 (4 pls.).

BRITZELMAYER, M.—Revision der Diagnosen zu den von M. Britzelmayer aufgestellten Hymenomycetenarten. (Revision of the diagnoses of Britzelmayer's new species of Hymenomycetes.)

Beih. Bot. Centralbl., xxvi. (1910) pp. 205-25.

KRIEGER, W.—Fungi saxonicæ, Nos. 2051-2100.

[Notes on locality and substratum, along with diagnoses of new species, are given.]

Konigstein, in Saxony, 1909.

See also *Bot. Centralbl.*, cxiii. (1910) p. 193.

* *Circ. and Agric. Journ. Roy. Bot. Gard. Ceylon*, iv. No. 23 (1910) pp. 307-21.

† *Op. cit.*, No. 22 (1909) pp. 197-305.

‡ *Journ. Board Agric.*, xvi. (1910) pp. 1010-11 (6 figs.).

§ *Tom. cit.*, p. 1012.

|| *Journ. New York Bot. Gard.*, x. (1909) pp. 241-56 (5 figs.).

MIGULA, W.—**Kryptogamen-Flora.**

[A study of Uredineæ is begun and continued. The genus *Puccinia* is the one dealt with in these fascicles.]

Flora von Deutschland, v. Lief. 85-90 (1910) pp. 321-416 (31 pls.).

MURRILL, W. A.—**Illustrations of Fungi. VI.**

[Coloured figures, with descriptions of species of the larger fungi, *Tricholoma*, *Boletus*, etc.]

Mycologia, ii. (1910) pp. 43-7.

PAUL, JOSEF—**Beitrag zur Pilzflora von Mähren.** (Contributions to the fungus-flora of Moravia.)

[A short list of Myxomycetes is also included.]

Verh. Nat. Ver. Brünn, xlvi. 1908 (1910) pp. 119-48.

PETCH, T.—**Revisions of Ceylon Fungi.**

[New descriptions of species imperfectly known, Hymenomycetes and Ascomycetes.]

Ann. Roy. Bot. Gard. Peradeniya, iv. No. 6 (1910) pp. 373-444.

" " **New Ceylon Fungi.**

[Diagnoses of a number of new species, saprophytic and parasitic. Two species of Myxomycetes are included.]

Op. cit., iv. No. 5 (1909) pp. 299-307.

PETERSEN, H. E.—**Studier over Ferskvands-Phykomyceter.** (Studies of Phycomycetes.)

Bot. Tidsskr., xxix. (1909) pp. 345-440 (fig.).

See also *Hedwigia*, xlix. (1909) p. 105.

PICARD, F.—**Sur une Laboulbeniacée nouvelle.**

[A new Laboulbenia, *Hydrophilomyces digitatus* sp. n., parasitic on *Ochthebius marinus*.]

Bull. Soc. Mycol. France, xxv. (1910) pp. 245-9 (1 fig.).

ROTH, J.—**Auftreten des Eichenmehltaus in Ungarn.** (Outbreak of oak mildew in Hungary.)

Naturw. Jahrb. Forst.-Landw., vii. (1909) pp. 426-7.

See also *Bot. Centralbl.*, cxliii. (1910) p. 149.

SACCARDO, P. A.—**Flora dell' Isola Pianosa. Fungi.** (Fungi from the island of Pianosa.)

[A list of fifty-seven species is published, mostly of the larger fungi; spore measurements are added.]

Nuovo Giorn. Bot. Ital., xvii. (1910) pp. 153-8.

SYDOW, H. & P.—**Fungi novi Philippinenses.**

[New species of microfungi.]

Ann. Mycol., viii. (1910) pp. 36-41.

TUNMANN, O.—**Ueber die Bildung des Harzes, den mikrochemischen nachweis der Harzsäuren und über die Kristalle in *Polyporus officinalis*.** (The formation of resin a microchemical proof of resin acids and crystals in *Polyporus officinalis*.)

Wochenschr. Chem. Pharm. Schweiz, 1909, pp. 157-64 (4 figs.).

See also *Bot. Centralbl.*, cxliii. (1910) pp. 155-6.

ZIMMERMANN, HUGO—**Verzeichnis der Pilze aus der Umgebung von Eisgrub** (List of fungi from the neighbourhood of Eisgrub, Moravia.)

[Chiefly Uredineæ, Ascomycetes, and Spheroideæ; some new species were found, and are described.]

Verh. Nat. Ver. Brünn, xlvi. 1908 (1910) pp. 60-112 (4 pls.).

Lichens.

(By A. LORRAIN SMITH.)

Lichens of the Azores.*—L. Navas informs us that the first record of Lichens from the Azores was made by Seubert in the *Flora Azorica* published in 1844. Several collectors have added to the number, and

* *Brot.*, viii. (1909) pp. 46-52.

the list now includes sixty-one species. Navas has substituted the generic name *Nemaria* (*nema*, filament) for *Roccella*. He explains that the Linnaean name *Lichen roccellus* was changed by De Candolle to *Roccella tinctoria*, that by the laws of priority we ought to call the lichen in question *R. roccella*, and since such a duplicated combination is contrary to the Vienna rules, it has become necessary to supply the new generic name *Nemaria* with the family name *Nemariaceae*.

HOWE, HEBER R.—Manual of the genus *Usnea*, as represented in North and Middle America.

[The writer recognises eight species in the North American flora; full descriptions are given.]

Bull. Torrey Bot. Club, xxxvii. (1910) pp. 1-18 (7 pls.).

JATTA, A.—Flora dell' Isola di Pianosa. Lichenes. (Lichens from the Island of Pianosa.)

[A list of thirty-three species is given, with one new species and one new variety.]

Nuovo Giorn. Bot. Ital., xvii. (1910) pp. 150-3.

STEINER, T.—Lichenes apud H. von Handel-Mazetti: Botanische Reise in das Pontische Randgebirge. (Lichens collected on H. von Handel-Mazetti's botanical journey in the Pontische Rand Mountains.)

[A number of new varieties and forms are included in the list.]

Ann. Nat. Hist. Hofmuseum, Wien, xxiii. (1909) pp. 107-23 (2 figs.).

See also *Bot. Centralbl.*, cxiii. (1910) pp. 374-5.

Mycetozoa.

(By A. LORRAIN SMITH.)

Mycetozoa of Ceylon.*—T. Petch first discusses the gatherings of species made by older botanists and determined mostly by Berkeley and Broome. He then gives a short account of the climatic conditions that prevail in the island and their effects on the growth of the organisms. During the first three months of the year mycetozoa are practically absent. Rain begins to fall in April, and there is a constant growth of species right on to December. Although the majority of Ceylon species are to be found in Europe, the relative abundance varies. Petch notes, as a consequence of the greater rainfall, a tendency to "wander," and the greater height from the ground at which species are found. He has collected species from rotten branches over 50 feet high. The dead leaf bases and the stems of living palms provide many species up to a height of 10 feet. The total number of species now known to occur in Ceylon is 102.

JAAP, O.—*Myxomycetes exsiccati*. Nos. 61-80.

Hamburg, 1909. See also *Bot. Centralbl.*, cxiii. (1910) p. 282.

LISTER, G.—Two New Mycetozoa.

[Two species of *Physarum*, both from Western America; one of them, *P. alpinum*, was also collected at Arolla, in Switzerland.]

Journ. Bot., xlviii. (1910) p. 73.

MEYLAN, CH.—*Myxomycetes der Jura*.

[The completion of Meylan's list of species from the Jura. There is one new genus, *Lamprodermopsis*.]

Bull. Soc. Vaud. Sci. Nat., xlv. (1910) pp. 49-57.

* *Ann. R. Bot. Gard. Peradeniya*, iv. No. 6 (1910) pp. 309-71.

Schizophyta.

Schizomycetes.

Bacterial Flora in the Ice of Monte Rosa.*—G. Galleotti and E. Levi record numerous observations as to the prevalence of bacteria at different heights on mountains. Their results amount to finding bacteria and hyphomycetes at all levels, but the varieties and the numbers increased from above downwards; also the number of germs was always greater in the neighbourhood of dwellings inhabited in the summer. They infer that the species may vary from time to time, as the varieties detected by them differ materially from those described by Scofone.

Morphology of the Microbe of Peripneumonia of Cattle.†—J. Bordet, after reference to the cultivation of the microbe of the pneumonia of cattle, points out that it is small enough to pass through a Chamberland F or a Berkefeld filter. He then describes the morphological aspects, which have resemblances to vibrios and spirochaetes. Borrel, Dujardin-Beaumetz, Jeantet, and Jouan, describe the appearances of the microbe under very high powers ($\times 5000$). The organism is extremely polymorphic, and its principal characters are that it possesses a mucous sheath and presents pseudo-mycelial filaments and numerous prolongations. They suggest the name of *Asterococcus mycoïdes*.

Bacillus bulgaricus vel B. lactis acidi Leichmann.‡—S. Makrinoff, after an exhaustive examination, comes to the conclusion that *B. bulgaricus*, *B. lactis acidi* Leichmann, *Streptobacillus lebenis* Rist and Khoury, *Bact. mazum*, Körnchen bacillus, are one and the same organism, and suggests that in future it should be known as Leichmann's bacillus, as he was the first to recognise it, or that it might be termed *B. lactis acidi*. He would further add viscosus or non-viscosus, according to the race it belonged to. The author also alludes to the lactic acid streptococci found in these sour milks, e.g. *Streptococcus hollandicus*. Weigmann points out there are at least two sorts, one able to grow at room-temperature on ordinary meat-pepton media, while *S. hollandicus* cannot.

Bacillus moniliformis.§—G. Repaci describes a bacillus, isolated from a case of pulmonary gangrene, which has certain resemblances to *B. ramosus* Veillon. Morphologically and tinctorially it is somewhat like the bacillus of Loeffler. It is slightly, but definitely motile, and is an essential anaerobe. The colonies are white and opaque with sharp margins. It forms gas, and exhales an aromatic odour. It does not coagulate milk, form indol, or attack white of egg. It reduces glucose energetically. It does not seem to possess striking pathogenic properties.

Micrococcus melitensis and Malta Fever.||—A. Conor finds that sheep are susceptible of Malta fever, and may transmit it like goats do

* Atti R. Accad. Lincei, xix. (1910) pp. 353-60.

† Ann. Inst. Pasteur, xxiv. (1910) pp. 161-79.

‡ Centralbl. Bakt., 2te Abt., xxvi. (1910) pp. 374-83.

§ C.R. Soc. Biol. Paris, lxxviii. (1910) pp. 410-12.

|| Tom. cit., pp. 678-80.

through their milk. Also he finds that *Micrococcus melitensis* may pass through the placenta, and so be transmitted from the mother to the foetus. Hence the once expressed hope that Mediterranean fever might be eradicated by replacing infected animals (goats) by their immunised offsprings would seem to have little validity, inasmuch as the offspring must have *M. melitensis* in their blood.

Quantitative Estimation of Soil Bacteria.*—J. G. Lipman and P. E. Brown have carried out a large number of estimations, using a synthetic agar medium of a slightly acid reaction, containing 1 p.c. of dextrose, 2 p.c. of agar, and small quantities of potassium-hydrogen phosphate, magnesium sulphate, and potassium nitrate. It was found, in the first place, that this medium allowed the development of a vastly greater number of soil organisms than slightly alkaline bouillon agar. Neutralisation of the acidity of the medium caused a large reduction in the number of colonies. Loam and shale soils were investigated, and the effect of modifying the nitrogenous portion of the medium was tried. When peptone was used as a source of nitrogen, partial neutralisation reduced the number of colonies from the shale to a much greater extent than those from the loam. The effects of increased acidity and increased proportions of peptone were investigated, and found to vary with the nature of the soil examined.

Media for Enumeration of Bacteria in Soil.†—Hugo Fischer compares the results of estimations of bacteria obtained by plating out soil on a number of different media. The author had, previous to this investigation, made use of a synthetic medium suggested by Arthur Meyer, which contains $1\frac{1}{4}$ p.c. of agar and small quantities of mineral salts. On comparing the counts obtained on this medium with those on Löhneis' soil-extract medium—containing agar, watery extract of soil and a small quantity of potassium-hydrogen phosphate—he found that much higher figures were obtained by using the latter medium. By using a dilute (0.1 p.c.) soda solution for preparing the soil extract he obtained a medium on which still higher bacterial counts could be obtained. The number of moulds was not affected to any great extent by the change of medium.

Stability of the Physiological Properties of Coliform Organisms.‡ In order to ascertain the extent to which the physiological properties of these organisms depend upon the nature of their habitat, C. Revis inoculated a number of strains into sterilised earth, peat, non-albuminous media, and so on. Tubes of material so inoculated were usually kept in the dark, at a temperature of 20°C., for several months, and an examination of their fermentation reactions, vegetative characters, and so on, was made each month. In general, it was found that the degree of fermentation of sugars and alcohols was altered, and organisms which had been kept on non-albuminous media lost their powers of fermentation to a large extent. The type of colony was in many cases considerably modified: on some highly nitrogenous soil *B. coli* developed a cementing substance and grew into very large jelly-like colonies. In another series

* Centralbl. Bakt., 2te Abt., xxv. (1909) pp. 447-54.

† Tom. cit., pp. 457-9.

‡ Op. cit., xxvi. (1910) pp. 161-78.

of experiments, the effect of symbiosis between two coliform organisms, *B. coli* and *B. lactis aerogenes*, was studied. It was found impossible to produce mixed colonies. The fermentation characters of *B. lactis aerogenes* were to a great extent paralysed by the presence of *B. coli*.

Morphological Differentiation of Bacillus paratyphosus and Bacillus typhosus.*—Kühnemann advocates examination by means of staining the flagella as an aid to the differential diagnosis of these organisms. He uses Loeffler's method of staining. In specimens so prepared, he finds that the relative proportion of the whole mass of flagella to the body of the bacillus is much greater in the case of paratyphoid A, than in the *B. typhosus*; in the former, too, the flagella themselves are longer and more convoluted, and tend to form an inter-lacing network in which the body of the bacillus is enclosed. The typhoid bacillus has fewer and shorter flagella, and these are but seldom entwined into a network. The absolute number of flagella is variable, but as a rule the paratyphoid bacillus has more than the typhoid bacillus.

Tuberculo-opsonic Index in Man and in Cattle.†—Strubell and Felder, in a large number of observations of the indices of fifty tuberculous patients, found that in 38 p.c. of observations the index was within the normal limits (0.9 to 1.10), in 33 p.c. it was subnormal, and 28 p.c. supernormal. The extreme limits of variation were between 0.37 and 2.1. Among healthy cattle, 88 p.c. gave a normal index to the human tubercle bacillus, and 71 p.c. to the bovine bacillus. In 21 p.c. the index to the bovine bacillus was above normal. Tuberculous cattle gave normal indices to human and to bovine bacilli in 83 and 58 p.c. of cases respectively. 34 p.c. gave supernormal indices to bovine tubercle. In cattle inoculated with human tubercle, active sera gave normal indices in 50 p.c. of cases to human, and in 45 p.c. to bovine tubercle. The percentages of subnormal indices were 46 and 52 respectively. Inactivated sera from the same cattle gave indices above 0.3 in 38 p.c. of cases against human, and in 7 p.c. against bovine tubercle. The authors give tables showing the proportional diminution of the index after inactivation of the serum, and the relative content of immune opsonin.

New Pathogenic Coccobacillus.‡—L. Laven gives an account of a hitherto undescribed micro-organism, which is pathogenic to rabbits, guinea-pigs and mice, giving rise in these animals to supplicative pleurisy and peritonitis. The organism was encountered first in the Institute of Hygiene at Kiel in the case of a guinea-pig which had been inoculated subcutaneously with a hard syphilitic chancre. This occurred in the year 1900, and since that date there have been from, time to time, deaths among the animals, due to the same infection. The organism is a short, stout Gram-negative bacillus, almost as long as it is broad. It is non-motile, possesses no flagellæ, and does not form spores. It grows best upon blood agar, but is also capable of growth upon ordinary media. It does not multiply at room-temperature, and accordingly is incapable

* Centralbl. Bakt., 1^{te} Abt. Orig. liii. (1910) pp. 473-5.

† Op. cit., liv. (1910) pp. 44-73.

‡ Tom. cit., pp. 97-105.

of growth upon solid gelatin. The author gives a table showing the morphological, cultural and pathogenic characters of this and other organisms which are pathogenic for laboratory animals.

Morphology of Cholera Vibrios in Peptone Solutions of Different Reactions.*—Y. K. Ohno observed that the shape of these organisms varied according to the reaction of the peptone solution in which they grew. The typical vibrio form was found in alkaline solutions of strength from 0.5 to 1.3 p.c.; the exact point was different in different strains. In more acid solutions rod forms were found, and in more strongly alkaline solutions the organisms were of a cocco-bacillary type. In view of this variation in point at which the organisms were found to be most typical, the author suggests that in the routine examination of suspected stools, three peptone solutions of reaction, 0.3 p.c. acid, 0.5 and 1.3 p.c. alkaline, should be employed.

Antagonism of *Bacillus bulgaricus* and *Bacillus diphtheriæ*.†—In this preliminary note, G. Rosenthal contributes to the study of the scientific basis of bacterio-therapy. As blood-serum, the most favourable medium for the diphtheria bacillus, is unsuitable for the Bulgarian bacillus, while milk has a converse effect, the author used milk-serum, which contains two parts of skimmed milk and one of serum, for his experiments. He found that when these organisms were planted at the same time upon milk-serum they could both be recovered by sub-cultivation up to the end of the fourth day. After that time the Bulgarian bacillus survived alone. Secondly, if the *B. diphtheriæ* was planted on a culture of *B. bulgaricus* it failed to gain a footing. The latter organism remained uncontaminated. But if the Bulgarian bacillus was planted upon a culture of the diphtheria bacillus the latter organism disappeared after a week. Lastly, he found the diphtheria bacillus could grow easily upon dead cultures of the lactic acid bacillus, and, if the acidity were carefully neutralised, upon living cultures also.

New *Bacillus* of Fowl-septicæmia.‡—From a number of fowls, victims of a wide-spread epizootic in Calcutta, G. C. Chatterjee has obtained an organism which, in its artificial culture and its pathogenic properties, resembles the bacilli of the hæmorrhagic septicæmia group. On the other hand, its morphological characters are peculiar. It is a minute coccus or cocco-bacillus, much smaller than a staphylococcus. It is Gram-negative and non-motile. The author assigns it, however, to the above group. From cultures, a vaccine was prepared which protected healthy fowls.

New Anaerobic *Streptococcus*.§—From a case of gangrene of the lung, G. Repaci has obtained a new streptococcus, to which he has given the name *Streptococcus parvulus non liquefaciens*. This organism occurs in chains of four to eight individuals; it is a strict anaerobe, and is Gram-positive. It grows on glucose-agar, gelatin and broth, under anaerobic conditions; gelatin is not liquefied; in broth culture, the growth is sedimentary. It does not ferment sugars, but milk is coagulated in

* Philippine Journ. Sci., iv. (1909) pp. 341-52.

† C.R. Soc. Biol. Paris, lxxviii (1910) pp. 349-51.

‡ Centralbl. Bakt., 1te Abt. Orig., liv. (1910) pp. 1-4.

§ C.R. Soc. Biol. Paris, lxxviii. (1910) pp. 292-3.

24 hours. Inoculation into laboratory animals, does not produce lesions of any importance. It differs from *S. anaerobius* Lewkowitz in its behaviour on gelatin and in milk. Further, it is a true coccus, whereas the organism of Lewkowitz may be lanceolate or bacillary. *Micrococcus fetidus*, another similar organism, does not grow on gelatin, and can, moreover, be distinguished by the characteristic odour of its cultures, from which the name is derived.

Cladothrix vaccinæ.*—From samples of glycerinated vaccine lymph 7 to 12 months old, G. Proca has obtained in pure culture a trichobacterium of the genus *Cladothrix*. This organism is characterised by a specific polymorphism and pathogenicity. After filtration through a Berkefeld N filter, the bacillary type in the filtrate, with serum-broth, assumes new forms. Firstly, there are undulating fusiform filaments, which give off small spherical or ovoid bodies. Then, there are large spherical bodies, which increase by budding. Inoculated into rabbits, by means of scarification of the internal aspect of the ear, cultures of the organism produce characteristic local lesions.

Further Study of New Iron-bacteria.†—David Ellis gives an account of the life-history of *Nodofolium ferrugineum* and *Leptothrix ochracea*, two members of the group of thread-bacteria recently isolated from iron-water. *Nodofolium ferrugineum* is a filamentous organism consisting of threads, whose structure is compared to a chain of lozenges viewed alternately in face and in profile. Multiplication is effected by the formation and abstriction of conidia. In germination, the conidium-membrane is burst open, and the new individual assumes, almost at once, the adult form.

The chief phases in the life-history of *Leptothrix ochracea*, the commonest of the iron-bacteria, have been described. The author has investigated the earlier stages, and finds that the stiff cell-membrane and deposition of iron is of comparatively late development. This organism affords a definite example of pleomorphism, as the spiral form, previously allocated to the genus *Spirosoma*, is now considered to be identical with the straight form, *Leptothrix ochracea*. The reasons for this identification rest partly on the observation that curvatures can be observed in the straight form, and partly on investigations of the earlier stages in the life-history.

BERTHELOT, A. — **Antagonisme du bacille bulgare vis-à-vis du meningocoque.**
C.R. Soc. Biol. Paris, lxxviii. (1910) p. 529.

BRIDRÉ, G., & L. NÈGRE — **Sur la nature du parasite de la lymphangite épi-zootique.**
Comptes Rendus, cl. (1910) pp. 998-1001.

GEORGEVITCH, P.—**Note préliminaire sur la formation et la germination des spores du Bacillus thermophilus jivoini sp. n.**
C.R. Soc. Biol. Paris, lxxviii. (1910) pp. 560-1.

LESNÉ, E., R. DEBRÉ, & G. SIMON—**Sur la présence des germes virulents dans l'atmosphère des salles d'hôpital.**

Comptes Rendus, cl. (1910) pp. 1001-2.

REPACI, G.—**Contribution à la connaissance de la vitalité des Microbes anaérobies.**
C.R. Soc. Biol. Paris, lxxviii. (1910) p. 524-5.

* C.R. Soc. Biol. Paris, lxxviii. (1910) pp. 375-7.

† Centralbl. Bakt., 2^{te} Abt., xxvi. (1910) pp. 321-9.

MICROSCOPY.

A. Instruments, Accessories, etc.*

(1) Stands.

New Heat Microscope.†—This instrument, designed by C. Doelter, is intended for the photography of melting and crystallising processes and for observation in various gases. The heating is electrical, as gas-heating is not sufficiently constant; the Microscope can be used for ordinary purposes if the heating chamber be removed and a special tube substituted. The instrument is meant to be more particularly applicable to:—1. Examinations of crystal plates, slides, etc., at temperatures not exceeding 1000° C., and in which polarised light should be serviceable. 2. Examinations of melting and crystallising processes up to about 1600° C., especially to the determination of melting points, solidification and reversal points; in these cases polarised light could be usefully applied up to about 1200° C. The principal distinction between these two classes is that sunlight or some strong artificial light (arc light) is used for the first; and that, for the second, the light from the incandescent chamber or object acts as the light-source. Even at temperatures from 700° to 1000° C. the incandescence might be used as a light-source, especially if the magnification required is not high. An electric arc-lamp with continuous current and automatic carbon regulators is used for the heating. The polariser is a nicol, set as is usual in mineralogical Microscopes. The stage is rotatory and has a circular form. In addition to an adjustable nicol the tube contains an upper rotatory nicol, and the ordinary gypsum or quartz wedges can be inserted. The stage is adjustable by means of two screws and the tube for centring purposes is also fitted with two screws. The tube is extensible for attaining higher magnification, and there is an insertion for replacing the stove (or heating chamber) by one of another size. The low and high temperature stoves have heights of 55 and 100 mm. respectively, with inner clear spaces of 12 and 10 mm. broad. The object-holder takes the form of a small platinum tripod or ring; for melting and crystallising observations a small quartz glass plate is used.

The interior of the stove is asbestos lined, and special pains are taken to exclude air currents, the top and bottom of the stove being protected with close fitting quartz glass plates. The electric current is taken from the domestic supply, or from a small battery of accumulators. The currents have respectively 3 amperes and 80 volts, and 5 amperes and 120 volts. Regulating is accomplished by suitable resistance methods, of which the author gives full particulars. The objective is made of

* This sub-division contains (1) Stands; (2) Eye-pieces and Objectives; (3) Illuminating and other Apparatus; (4) Photomicrography; (5) Microscopical Optics and Manipulation; (6) Miscellaneous.

† SB. k. Akad. wiss. Wien., cxviii. (1909) pp. 489-9 (3 figs.).

uncemented chromium glass and flint glass, and is embedded in a water reservoir through which a current constantly circulates.

Fig. 47 shows the complete installation. A small chamber containing a prism is placed over the tube, thus affording direct observation downwards and photographic observation laterally. In order to get sharp images one of the nicols has an arrangement for the insertion of a red or orange disk to act as a filter.

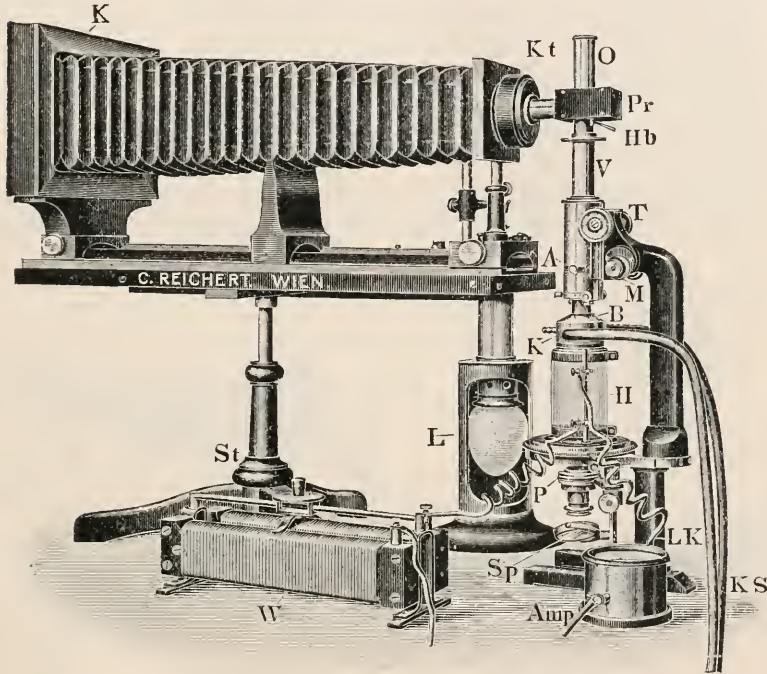

FIG. 47.

For observations in a gas atmosphere a gas current is made to circulate through the interior of the stove, the top being shut down with a quartz glass plate.

(3) Illuminating and other Apparatus.

Dark-field Illumination and Ultramicroscopy in Biology and in Medicine.*—N. Gaidukov's treatise under the above title gives what appears to be a very complete account of the present state of ultramicroscopy. It contains 74 pages of text, 9 pages of bibliography, and 5 plates with descriptive notes. There is also a preface in which the author reminds us that Ultramicroscopy has not been recognised as a distinct branch of science for more than seven years. The work

* *Dunkelfeldbeleuchtung und Ultramikroskopie in der Biologie und in der Medizin.* Von N. Gaidukov. Mit 13 Abbildungen im text, 3 Lichtdruck- und 2 Chromolithographischen Tafeln. Published by G. Fischer, Jena, 1910.

is divided into ten chapters. Chapters i. and ii. (pp. 1-15) discuss apparatus and the structure of colloids. Chapter iii. (pp. 16-25) deals with the ultramicroscopic examination of liquid colloids, specially interesting to the biologist and the physician. Chapters iv. and v. (pp. 25-48) are occupied with blood, bacteria, and other such microscopic objects. Chapter vi. (pp. 49-59) describes the author's own researches on certain botanical objects (e.g. spirogyra, desmids, etc.). Chapters vii. and viii. (pp. 60-67), plant cells, colloids, and textile fibres. Chapter ix. (p. 73) is a summary; and Chapter x. (pp. 74-83) is bibliographical.

The bibliography includes some 202 items. The plates include some well-known objects (e.g. desmids, spermatozoids, etc.), as seen by bright-ground and by dark-ground methods. The difference in appearance is sometimes very remarkable.

Micrometric Measurements by a Projected Scale.*—F. J. Clendinnen gives the following description of the method devised by him.

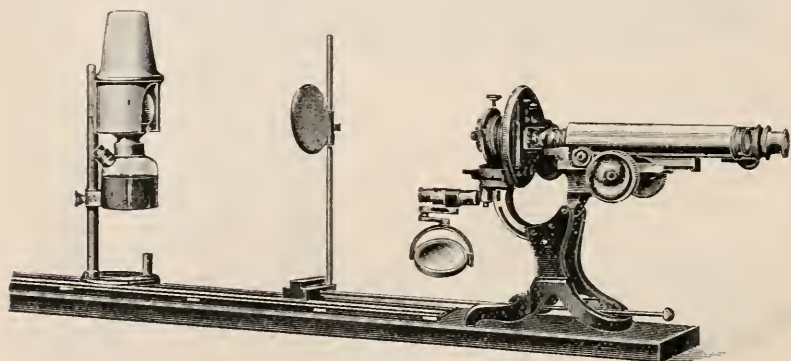

FIG. 48.

The apparatus (fig. 48) consists of a wooden base 3 ft. in length and 8 in. wide, which carries the Microscope; and a pair of steel rails, $2\frac{1}{2}$ in. apart, parallel with which is placed a scale graduated in centimetres and millimetres. The tripod of the Microscope is fitted into slots on the wooden base, so that its position is fixed while in use, but the Microscope can be easily removed. The metal rails are projected forward from the base of the tripod, and upon them runs an upright metal rod carrying the screen, which may be lowered or raised by means of a small set screw. Behind the screen, the rails also carry the lamp, which may thus be adjusted to any requisite distance. A micrometer of known value being in position in the Microscope stage, the reticule upon the screen may now be compared at various distances. These distances being read off by means of the scale placed between the rails, the value of the screen reticule becomes accurately known, and the stage micrometer may now be dispensed with, as it is used merely to determine an exact calibration.

* Trans-Australasian Med. Congress, 1908, ii. (1909) pp. 377-8 (1 pl.).

The Screen.—The screen consists of a disk of glass on which are photographed rulings forming a reticule of five divisions to the square. It is thus apparent that, by adjusting the screen at various distances, a micrometer of various known dimensions is obtained. In the perpendicular position, the screen is reflected by the illuminating mirror through the condenser, by which an image of the reticule is formed on the object. In the horizontal position, the micrometric image is transmitted direct through the condenser, and an image of the reticule is formed on the object. The screen may be readily swung in or out of the field as desired.

The Direct Method.—The Microscope is placed horizontally. The screen is centred by focusing with the condenser a small spot in the centre of the ground glass. The ground glass is now removed, and the screen is placed in the carrier in its stead. The object to be measured is focused in the ordinary way, and then the scale is focused by the condenser, an image of the scale is thrown on the object, the scale which has been previously calibrated on the rails is read off, and the size of the object determined.

The Indirect Method.—This is used when it is necessary to have the Microscope in an upright position. The same applies here as regards the scale, only in this method the plane mirror is used to reflect the parallel rays up through the condenser. First centre the light with the mirror (plane side), focus the stage micrometer as before, place your screen in situ, and focus it on to the stage micrometer, compare with it, and calibrate your rails accordingly.

Advantages over other Micrometers.—1. The micrometer is easily placed in or out of the field whilst examining an object. 2. The whole field is divided into squares. 3. It can readily be adjusted to various known measurements by simply sliding the carrier on the calibrated rails. 4. It has advantage over the eye-piece micrometer in so much as it is not always in the field of vision, and moreover it has a greater range of measurements. 5. It measures areas instead of lines. 6. By using the camera lucida, the object may not only be easily drawn, but accurately measured.

This ghost micrometer is not new and has been repeatedly re-invented: e.g. by Goring circa 1820; Royston Pigott, circa 1870, A. E. Wright, 1890, and others.

(4) Photomicrography.

- **Method of Estimating the Exposure in Photomicrography, with Axial Cone Illumination.***—Duncan J. Reid remarked that it is generally admitted that to obtain good results in photomicrography, it is necessary that the exposure should be correct. One important feature of this method is that it enables one to record the conditions under which a photograph had been taken, and that with such accuracy as to make it possible to repeat it on any future occasion. It is based on the method of calculating the "working aperture," by the measurement of the Ramsden disk of the eye-piece, described by Sir A. E. Wright in his book on the "Principles of the Microscope." It presupposes carefully centred axial cone illumination, from a source of light at a fixed distance,

* Journ. Quekett Micr. Club, 1903, pp. 486-9.

and, with the help of a Nelson or other collecting lens and a substage condenser of a power suited to the objective in use, so arranged as to just fill the back combination of the objective with a uniform solid cone of light, at full aperture, and so as to give critical illumination and a uniformly illuminated field on the ground glass of the camera. To obtain these results it might be necessary, with objectives below $\frac{1}{2}$ in. (12 mm.) to employ a supplementary collecting lens, in the course of the beam from the Nelson lens. The factors to be taken into consideration in estimating the exposure, were:—1. *The magnification*, which increases the exposure in the direct ratio to the square. 2. *The light*: Exposure tables were shown, based on a standard obtained with the edge of the flame from a $\frac{3}{4}$ in. wick kerosene lamp as a source of illumination. A single 1 ampere filament Nernst lamp, working from 100 volt current, required $\frac{1}{5}$ of those exposures. 3. *The plate*: The photographic plate on which the tables were based was the Ilford chromatic—a colour-sensitive plate of medium rapidity. A standard was found by making a series of strip exposures on such a plate, at a given magnification and aperture (250 diameters, and 0.50 N.A.), from which a table of exposures at that aperture could be calculated for all other magnifications. 4. *Numerical aperture*: It was a very common custom in recording the conditions under which a photograph had been taken, to say that a lens of 1.20 or 1.30 N.A., i.e. its full numerical aperture, had been employed. What was, however, really required was the aperture at which the lens had been worked—the working aperture—which affects the exposure in the inverse ratio to its square. A second table was therefore shown, giving the factors by which the exposures found from the first table should be multiplied or divided, so as to give the exposure required at varying working apertures. To use this second table it was necessary to be able to estimate the working aperture which had been found to give the result desired. If we take a finely divided glass measure, giving say millimetres and tenths of a millimetre, and hold it exactly in the position of the Ramsden disk of the eye-piece, and focus both it and the Ramsden disk simultaneously with a focusing glass, so adjusted that it is in focus when its mount rests on the surface of the measure, it is possible to estimate the diameter of the Ramsden disk of the ocular. Multiplying that diameter by the number of the ocular (giving the number of times it magnifies the result obtainable by the objective alone) we obtain the diameter of the cone of light emergent from the back combination of the objective. If we now divide the semi-diameter of that cone by the equivalent focal length of the objective, in millimetres (usually marked on objectives, now-a-days), we obtain as a result the “working aperture” of the lens.

For instance, if a 4 mm. apochromat be used, the full N.A. of which is 0.95, and a No. 4 ocular, the diameter of the Ramsden disk of the eye-piece may have been found to be 1 mm. This multiplied by the power of the ocular (4), gives us 4 mm. as the diameter of the emergent beam from the back of the objective; the half of that (2 mm.) is the semi-diameter of that beam, which divided by 4, the equivalent focal length of the objective, gives us 0.50 as the working aperture of the lens.

We have therefore all the information required to make use of the following table:—

TABLE OF EXPOSURES FOR MEDIUM AND HIGH MAGNIFICATIONS.

Using edge of $\frac{3}{4}$ -in. flame of Kerosene lamp, Nelson paralleliser, and condenser at its critical focus.

For Ilford Chromatic Plates.

At N.A. of 0.50.		Multiplying and Dividing Factors for calculating Exposures at different N.A.	
Diameters.	Exposures.	N.A.	Factors.
100	1" to 1.3"	0.10	× 25.0
150	2" " 3"	0.15	× 11.0
200	4" " 5"	0.20	× 6.0
250	6" " 8"	0.25	× 4.0
300	9" " 11"	0.30	× 3.0
350	12" " 16"	0.35	× 2.0
400	16" " 20"	0.40	× 1.5
450	20" " 26"	0.45	× 1.2
500	24" " 32"	0.50	Standard
600	35" " 46"	0.55	÷ 1.2
700	47" " 65"	0.60	÷ 1.4
750	54" " 70"	0.65	÷ 1.6
800	62" " 80"	0.70	÷ 2.0
900	1' 20" " 1' 45"	0.75	÷ 2.2
1000	1' 40" " 2' 10"	0.80	÷ 2.5
1500	4' " 4' 50"	0.85	÷ 3.0
2000	7' " 8' 30"	0.90	÷ 3.2
3000	15' " 19'	0.95	÷ 3.5
4000	26' " 34'	1.00	÷ 4.0
..	..	1.05	÷ 4.4
..	..	1.10	÷ 5.0
..	..	1.15	÷ 5.3
..	..	1.20	÷ 5.8
..	..	1.25	÷ 6.2
..	..	1.30	÷ 6.8

Note.—The higher exposures are for fully exposed negatives. Nernst 1-ampere filament lamps require $\frac{1}{15}$ of these exposures.

A table of exposures for low magnifications, at low working apertures, based on the same principles, is also given. The following practical points in connection with making the measurement of the Ramsden disk are mentioned : (1) It is easier to make it with a low-powered eye-piece, which can then be changed for the one with which the photograph is to be taken ; (2) it is generally better to move the object to be photographed to one side, whilst it is being done : (3) it is necessary to interpose a screen of smoked or dark green glass between the eye and the light, which should then be removed before the exposure is made ; (4) the markings on the millimetre measure should be coarse. Anyone who intends to use this method of estimating exposures should work out a standard for himself, as the intensity of the illumination depends so much on the arrangement of the collecting and condensing lenses, and on the source of light. If found to be the same as in the table, well and good ; if not, a magnifying or dividing factor could be found to be used with this table, or, if preferred, a new table could be worked out. If yellow or other coloured screens are employed, they ought to

be standardised by making test exposures on the make of plate to be used, with and without them. Those who wish to read the method in more detail may refer to the full report to be found in the Transactions of the Royal Photographic Society for January 1909.

(6) Miscellaneous.

Refractive Index of Canada Balsam.*—The refractive index of Canada balsam, says W. T. Schaller, as it occurs in the thin sections made for the U.S. Geological Survey, was determined on the request of F. C. Calkins, who had found † that the index, or n , was not absolutely constant, but varied between two extremes. By the examination of 300 slides, he found n to reach and even slightly exceed n of quartz (1.544), though n was found greater than 1.544 only in the proportion of one slide in a hundred. The excess was very small and the balsam was decidedly yellow. The lowest value found by him was about $1.535 \pm .002$.

The value of n for sodium light was determined on an Abbe-Zeiss refractometer by total reflection on three kinds of slides, which were (1) not cooked as much as usual, (2) cooked as ordinarily done, and (3) over-cooked. The differences found between (1) and (2) are very slight, and, in fact, the individual values show almost as much variation as between the different groups. The values obtained are :

$$\begin{array}{ccc}
 \text{(1)} & \text{(2)} & \text{(3)} \\
 n = \begin{cases} 1.539 \\ 1.538 \\ 1.539 \end{cases} & n = \begin{cases} 1.536 \\ 1.538 \\ 1.539 \end{cases} & n = \begin{cases} 1.543 \\ 1.540 \\ 1.540 \\ 1.542 \\ 1.541 \end{cases}
 \end{array}$$

The average values are for (1), 1.5387; for (2), 1.5377; for (3), 1.5412, or, as the average of all, 1.5395, which is almost identical with the value (1.5393) given by Becker ‡ in 1898. A determination of n in a slide six years old gave the value 1.5390. These values show that, in general, n lies very close to 1.539, and that this value may well be used in a study of a thin section, while the actual possible variation was found by Calkins to be from 1.535 to 1.545, though the extreme values are but seldom reached. The uncooked liquid balsam has a refractive index of 1.524, which, after cooking, rises to 1.54. The older a slide, the higher the index of the balsam becomes, which after a time, especially if the air has access, reaches towards the highest value, or 1.545.

B. Technique. §

(1) Collecting Objects, including Culture Processes.

Solmedia.—At the meeting of the Society held April 20, F. R. Chopping, assistant in the Clinical Laboratory at the Westminster

* Amer. Journ. Sci., xxix. (1910) p. 324.

† Science, xxx. (1909) p. 973.

‡ Amer. Journ. Sci., v. No. 4, p. 349.

§ This subdivision contains (1) Collecting Objects, including Culture Processes; (2) Preparing Objects; (3) Cutting, including Imbedding and Microtomes; (4) Staining and Injecting; (5) Mounting, including slides, preservative fluids, etc.; (6) Miscellaneous.

Hospital, exhibited specimens of bacteriological culture media in dry concentrated form (provisional name, "Solmedia" = solid media). As they are light and of small bulk, they can be sent by post at cheap rate. They do not deteriorate, have hitherto kept extremely well, and will probably do so for quite a long time; hence they will be invaluable for work in warm climates, especially tropical. The method of using the media, which is quite simple, is as follows: 5 c.cm. of water are to be added to a given weight of solmedium in a test-tube; the test-tube is then placed in a waterbath for about 30 to 45 minutes, and afterwards allowed to set in the required position. In this way a tube of sterile media is cheaply and easily prepared. Samples of unused "solmedia" culture tubes were exhibited and also cultures of various organisms in various media, as well as uninoculated tubes of media. This method of producing dry concentrated media, which took the inventor about two years to elaborate, will be found to be extremely useful both for persons who require small quantities of cultivation media and also for institutions where many tubes are used daily. A list of the tubes shown will be found in the Proceedings of the Society for April, p. 397.

Solmedia are put up in tubes containing sufficient to make 12, 50 and 100 5-c.cm. tubes. They are also supplied in sterile test-tubes plugged with sterile cotton wool. Each tube contains sufficient solmedia to make a tube of media on the addition of about 5 c.cm. of water. The solmedium is firmly adherent to the bottom of the tube, so that the tubes will stand any amount of transport, and can be stored in any position.

Collecting and Examining *Ganymedes anaspidis*.*—J. S. Huxley obtained specimens of *Ganymedes anaspidis* g. et sp. n., a Gregarine from the digestive tract of *Anaspidis tasmanicæ*. Some of the hosts had been pickled in formalin, others in sublimate. Preparations were made by staining gut and liver tubes whole in para-carminé for 2 hours, and eventually teasing out on a slide in balsam, removing as much débris as possible and leaving the parasites behind. When *Anaspidis* were fixed quite fresh, their guts were found to be filled with sand; in such case the *Ganymedes* had to be picked out under a dissecting Microscope. They were then passed from 90 p.c. alcohol to a slide previously smeared with egg-albumen. They were then stained with iron hæmatoxylin, or with Ehrlich's hæmatoxylin and eosin, or with methyl blue-eosin by Mann's method.

Testing for Indol in Microbic Cultures.†—C. Porcher and L. Panisset find that as a rule the quantity is small, and the extract must be concentrated to give a proper reaction. They first obtain the extract by shaking up with ether, then add a few drops of alcohol, and afterwards reduce the extract to $\frac{1}{10}$ of its original bulk. To about 5 c.cm. is added $\frac{1}{2}$ c.cm. of a 5 p.c. alcoholic solution of p.-dimethylaminobenzaldehyde. Then 1 c.cm. of strong HCl is poured down the tube; a ruby-red ring appears at the junction.

* Quart. Journ. Micr. Sci., lv. (1910) pp. 156-7.

† C.R. Soc. Biol. Paris, lxxviii. (1900) pp. 653-5.

Artificial Culture of Marine Plankton Organisms.*—E. J. Allan and E. W. Nelson give an account of an extended research into methods of cultivating plankton diatoms in sea-water media. In their paper they call any diatom culture which can be carried on practically indefinitely by inoculating fresh supplies of prepared water, a "persistent" culture. Strictly "pure" cultures have not been obtained, but most of the "persistent" cultures contain only one species of diatom, and are free from all organisms larger than small flagellates.

As culture media, the authors used sea-water ("outside" water or "tank" water), sterilised and unsterilised, prepared either by the addition of Miquel's saline solutions or the authors' modifications of these solutions, or in other cases by treatment with animal charcoal or peroxide of hydrogen. It was found unnecessary to add the organic infusion recommended by Miquel. The best medium was found to be sterilised "outside" water (i.e. water from the English Channel) treated with Miquel's solutions, and the next best was sterilised tank water treated with animal charcoal.

In order to discover the conditions which underlie the successful cultivation of diatoms, they exposed a number of cultures to varying conditions of salinity and alkalinity as well as to varying degrees of light and temperature. It seems necessary to raise the concentration of nitrates, or possibly of phosphates, above that found in ordinary sea-water. The influence of hydrogen peroxide or animal charcoal appears partly nutritive, partly protective, effecting the removal of toxic substances. Light is the most important physical factor, the rate of growth in a suitable medium depending directly upon its intensity.

A number of flasks were inoculated with mixed cultures by taking plankton fresh from the sea. In general, the true plankton diatoms are the first to develop in considerable numbers. After two or three weeks, infusoria, algae, and the bottom diatoms, gain the upper hand, and the true plankton forms die out.

The remainder of the paper is devoted to the study of the life-history of certain species of diatoms, and to the methods of rearing marine larvæ in sterile sea-water with a pure culture of a suitable food.

Simple Anaerobic Methods.†—A. Tedeschi gives an account of his application of Marino's methods. For the isolation of anaerobes he uses a culture medium pressed between two sterile-glass surfaces. The medium is inoculated and kept at a temperature of 42° C. for half an hour. It is then poured into the inverted cover of a Petri dish, and then the Petri dish itself is placed with its outer surface upon the surface of the nutrient medium. If the surface of the glass is even, access of air is thus excluded.

The author is also able to cultivate anaerobes in deep culture in ordinary agar. The medium is melted and cooled to 42° C., at which temperature it remains liquid. Sterile glass beads are dipped in broth—to remove adherent air—inoculated with the culture material, and dropped into the agar. They fall to the bottom of the tube, carrying the inoculum with them.

* Journ. Marine Biol. Assoc., Plymouth, viii. (1910) pp. 421-74.

† Centralbl. Bakt., 1te Abt. Orig., liv. (1910) pp. 105-8.

Cultivation of the Tubercle Bacillus upon Animal Tissues.†—C. Frongoni found that portions of the organs of animals, suitably prepared, form an excellent medium for the cultivation of tubercle. Prismatic pieces of the lungs of rabbits and dogs were heated for 45 minutes in an autoclave, and then placed for two hours in 6 to 8 p.c. glycerinated water. They were then put in sterilised tubes, containing a small quantity of glycerin and water to prevent drying. The tissue is kept away from the glycerin bath by means of a constriction of the tube upon which it rests. Upon such a medium the growth of *Bacillus tuberculosis* takes place very rapidly, and the culture possesses great vitality. This method is likely to be of great use for the isolation of the bacillus from tuberculous tissues.

Comparative Value of recent Typhoid Culture-media.‡—W. Gaetgens and G. Brückner, in the examination of a hundred stools, mostly from typhoid patients, employed the following media: Conrad's brilliant-green picric acid agar, Padlewsky's sodium sulphite malachite-green agar, Endo's fuchsin agar, Werbitzki's china-green agar, Gaetgen's caffein-fuchsin agar, and the malachite-green agar of Lentz and Tietz. They found that the medium of Lentz and Tietz was the most satisfactory, and for rapid differentiation of the *Bacillus typhosus* fuchsin agar most suitable. By means of these new media it was possible to isolate the bacillus in 50 p.c. of cases in the first fortnight of the disease, and in 75 p.c. of cases in the first three weeks. This shows that examination of the faeces in the diagnosis of typhoid is no less valuable than agglutination tests or blood culture.

Cultivation of *Oidium albicans* from Throats.*—From swabbings of the throats of 300 cases of suspected diphtheria, Heidsieck was able to isolate *Oidium albicans* in thirteen. The organism was encountered, also, in a number of other cases where the overgrowth of bacteria made isolation impossible. From blood serum, the dull white colonies of *O. albicans* were transplanted on to beet-wort gelatin. On this medium the colonies were at first round, sharply defined, and of a brownish colour. After a few days, thread-like processes were found projecting from the colony, some radially, some tangentially. The author compares the cultural characters of this organism with those of *Saccharomyces cerevisiæ* and *S. ellipsoideus*. Experiments were also carried out with a view to ascertaining the pathogenicity of this yeast, and comparing it with that of other yeasts and moulds.

(2) Preparing Objects.

New Method of Fixing Plankton.†—L. Meunier and C. Vaneý have used for two years a 2-4 per thousand solution of quinone for fixing plankton. The compounds formed by the reagent with albuminous substances are more stable than those obtained by means of formalin or the chromic acid salts. After a lapse of time certain structures stain brown; this browning facilitates the identification of the parts affected,

* Centralbl. Bakt., 1te Abt. Orig., liii. (1910) pp. 553-7.

† Tom. cit., pp. 559-76.

‡ Op. cit., liv. (1910) pp. 103-14.

§ C.R. Soc. Biol. Paris, lxxviii. (1910) pp. 727-9.

such as nuclei, muscular fibres and glands. The plankton, either salt or fresh-water, is allowed to remain for 24 hours in the quinone solution, which must be freshly prepared as it decomposes under the influence of air, water and light. After an immersion of 24 hours the quinone is replaced by 70 p.c. alcohol. When it is desired to mount the animals in toto, they are passed through upgraded to absolute alcohol, to which last is gradually added either oil of bergamot or oil of cloves; after a stay of some hours in the pure oil, the animals are mounted in balsam. For histological examination the quinone may be combined with perchloride of mercury, picric and acetic acids. As the reaction of quinone is neutral it does not interfere with staining reactions, and, indeed, may act as a mordant.

Studying Metamorphosis of Muscidæ.*—C. Pérez in his research used *Calliphora erythrocephala*: specimens at every stage of development were examined, and the methods of fixation and staining were very varied. The chief fixatives were acetic-acid-sublimate and the picro-formalin of Bruin. As a nuclear stain Mayer's hæmalum was mostly used, the plasma being contrast stained with eosin and aurantia. Often the iron-hæmotoxylin method was substituted for the hæmalum. Occasionally the preparations were contrast stained with carmine hydrochloride, and then differentiated with picro-indigo-carmin. For osmic acid fixation, Borrel's formula was adopted (osmic acid 2, platinum chloride 2, chromic acid 3, glacial acetic acid 20, water 350). After 24 hours the preparations were washed in running water. The sections were contrast stained with 1 p.c. magenta red, and afterwards for 10 to 20 minutes in picro-indigo-carmin (saturated aqueous solution of picric acid 1 vol., saturated aqueous solution of indigo-carmin 2 vols.). The preparations were differentiated with absolute alcohol and oil of cloves. The author points out that osmic acid penetrates feebly, and therefore this reagent should not be adopted as the chief fixative.

Studying the Neurofibrils in Lumbricus.†—J. Kowalski finds that in order to successfully demonstrate the neurofibrils in *Lumbricus*, the silver impregnation should be effected by means of an acid medium, and the fluid used by him which gave the best results was composed of formol 25 c.cm., glacial acetic acid 5 c.cm., distilled water 100 c.cm.

Two other fixatives recommended by Bouin were as follows:—1. Distilled water 100 c.cm., formol 25 c.cm., glacial acetic acid 5 c.cm., ammonia 0.5 c.cm. 2. Alcohol 94 p.c. 100 c.cm., formol 75 c.cm., glacial acetic acid 5 c.cm., ammonia 0.5 c.cm.

(3) Cutting, including Imbedding and Microtomes.

Studying Eye of Pecten.‡—W. J. Dakin carried out his investigations on the eye of *Pecten* by means of paraffin and paraffin-celloidin sections, by maceration preparations, and by teased out specimens of fixed material. Maceration was found to give important results, and it was noted that different reagents were requisite for maceration and fixation purposes. The best fixatives were Zenker's fluid and Carnoy's

* Archiv Zool. Expér. et Gén., xlv. (1910) pp. 1-274 (16 pls. and 162 text figs.).

† La Cellule, xxv. (1909) pp. 291-347 (4 pls.).

‡ Quart. Journ. Micr. Sci., lv. (1910) pp. 53-6.

mixture. After Zenker the preparations were stained with Mallory's fluid (anilin-blue 0.5, orange G 2, oxalic acid 2, H₂O 100), Heidenhain's iron-haematoxylin, Weigert's and Van Gieson's methods. When Carnoy's fluid (chloroform 10, acetic acid 30, absolute alcohol 60) was used for fixing, the preparations (retina) were stained with iron-haematoxylin and Bethe's toluidin-blue. Several other methods were adopted, but the foregoing seem to have given satisfactory results. In reference to maceration, it is stated that the lens-cells were easily isolated after immersion of the eyes in 3 p.c. solution of chloral hydrate in sea-water for about 4 hours. The same solution was used for the retinal cells. After two hours the retina was dissected out, placed in a drop of water on a slide, and a cover-glass supported by wax feet placed over it. Gentle tapping on the cover-glass separated the elements. Chromic acid, .02 p.c. in sea-water, gave good maceration results for rod-cells and rods. Maceration preparations were examined transformed and stained with picro-carmin.

Improved Brain Microtome.*—K. Berliner describes a new type of microtome with a large stage (fig. 49) suitable for cutting sections of

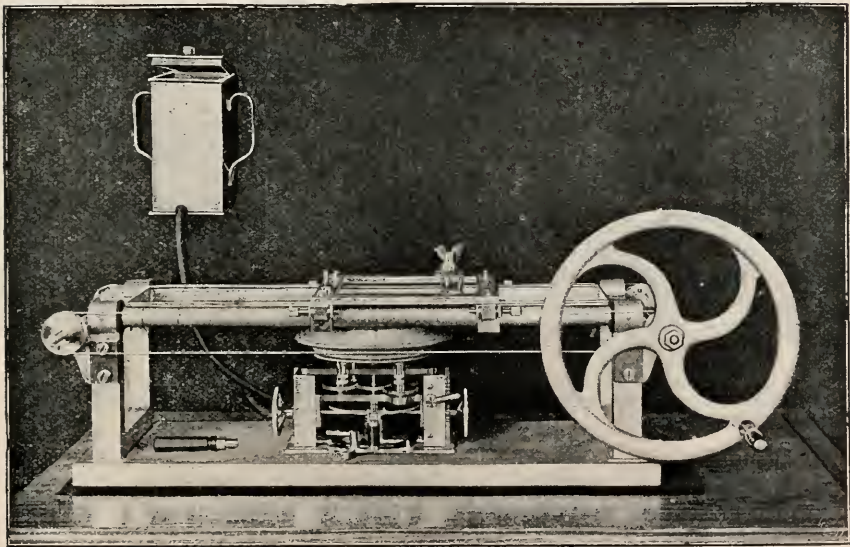

FIG. 49.

large objects, such as the brain. The knife is firmly fixed at each end, and its handles move along rigid cylindrical guide-bars. By means of an accessory apparatus, it is possible to cut sections under alcohol. The mechanism for adjusting and raising the stage is of a new type, fully described in the original paper.

* Zeitschr. wiss. Mikrosk., xxvi. (1909) pp. 378-81.

Injecting Kidney of Teleostean Fish.*—J. Andigé anaesthetised the fish by putting chloroform into the water in which the animals were contained; the fish were then bled by means of a transverse cut made through the body behind the abdominal cavity. When devoid of blood the arterial system was injected by means of the following procedure. A 1 p.c. solution of nitrite of amyl in distilled water is syringed into the caudal vein; this done, the caudal vein is ligatured and the syringe inserted into the aortic orifice and the procedure repeated. The canula is left in the artery, and through it is passed the injection mass. That which gave the best results was gelatin coloured with Ranvier's soluble blue; Fol's metagelatin with Prussian blue was also successful. Injections of the venous system were made through the caudal vein or through the posterior cardinal veins, after bleeding, and previously washing out with nitrite of amyl solution. These venous injections were not invariably successful, and the author found that Retteser's procedure could be relied on. This process consists in immersing the whole animal, with the abdominal cavity freely open, in Müller's fluid. The vessels naturally injected are distinguished with facility, and their dissection is quite easy. Injections of the renal tubules were also tried by the methods of Guitel and Altmann. Altmann's method, which consists in injecting olive oil through the ureters and then treating the injected organ for 24 hours with 1 p.c. osmic acid, gave the better results. Though rendering useful service, neither was entirely satisfactory.

Method of Preparing Frozen Sections of Brain-substance.†—Y. Nageotte gives an instructive account of difficulties met with in such work, and devices for overcoming them. He commences by cutting the hemispheres into slices of about 1 cm. thick. The anterior and posterior portions are cut vertically and the intermediate, horizontally, so that the principal bundles are cut at right angles. The slices must be divided into several portions suitable for the microtome plate. If a disc of liver be first frozen on to the plate, and the block of brain frozen on to this liver bed, the usual waste of the last portion of each block is avoided.

To avoid the deleterious effect of ice-crystals upon the grey matter, the block is immersed first in 3 p.c. formalin. It is then sprayed with methyl chloride on all its sides, and thus the surface is rapidly frozen. It is then gummed to the microtome plate. This can be maintained at a temperature of -10° C. The sections are carefully removed with fingers or forceps, and washed in water. Sections can be cut at a thickness of $40-80 \mu$.

Before staining, the sections are placed in 90 p.c. alcohol for a few minutes. The addition of 30 p.c. glacial acetic acid to this bath prevents shrivelling. The section is then spread on a glass plate, and stained with hæmalum (Mayer's hæmalum 2 parts, absolute alcohol 1 part) for half an hour in a warm stove. It is then washed with water and placed in a modification of Weigert's decolorising fluid, washed, passed through alcohols, cleared in xylol, and mounted in balsam.

* Arch. Zool. Expér. et Gén., xliv. (1910) pp. 275-624 (104 figs.).

† C.R. Soc. Biol. Paris, lxxvii. (1909) pp. 542-5.

Microscopical Sections through both Cerebral Hemispheres.*—G. Bonvicini prepares his material by putting it into solution containing a potassium chromate (4 p.c.) and chromium sulphate (2.5 p.c.) for a period varying from a fortnight to two months, according to the size of the pieces. At first the solution is changed weekly. If the whole cerebrum is to be so treated, the ventricles are injected with 10 p.c. formalin by means of a serum syringe. After the chromate stage, the brain is slung for six or eight days in a large vessel containing formalin. The brain so prepared is then cut into slices by means of a macrotome devised by the author (fig. 50). This instrument consists of a wooden base H_1 , upon which a wooden platform H can be moved by a screw,

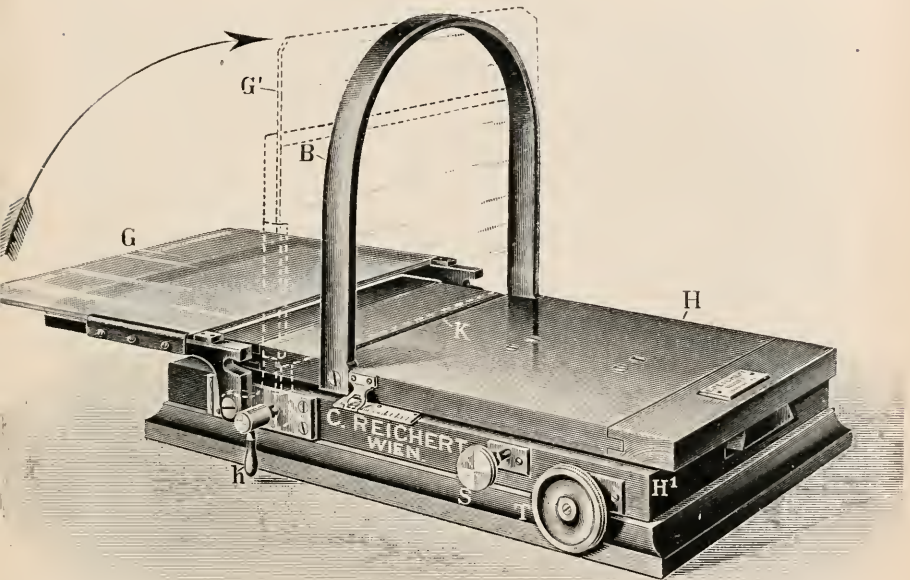

FIG. 50.

controlled by the milled head T. To the base is hinged a glass plate G, which can be moved through 90° into the position G^1 . The platform H carries a stout vertical metal bow B, which guides the knife. At K, where the knife would strike the platform H, a strip of cork is inserted to prevent injuring the blade. The brain is placed on the board H, and pushed through the bow B, as far as the glass plate G in its vertical position will allow. The distance of the plate G from the bow B, and consequently the thickness of the slice cut, is controlled by the screw-head T. The surface of these slices may be stained and examined, or fine sections may be cut by means of a microtome.

* Zeitschr. wiss. Mikrosk., xxvi. (1909) pp. 410-18.

Cooling of Paraffin Blocks.*—D. Carazzi made observations upon the effect of different methods of cooling paraffin blocks. Some blocks were allowed to cool slowly at room temperature, others still more slowly in a paraffin oven from which the source of heat had recently been removed. Other blocks were cooled by means of water at different temperatures. The most satisfactory blocks were those which had been cooled by the addition of water at room temperature. The block should remain in this water until solidification is complete. Slow cooling makes the block unsatisfactory from a lack of homogeneity. Too rapid solidification is also unfavourable.

(4) Staining and Injecting.

Quick Method of Preparing and Staining Pollen.†—After trying staining the grains and clearing them in phenol and xylol, which failed to remove the stain and also presented great difficulties in manipulation, W. Wesché tried the following quick method, which answered admirably. The flowers were collected during the period August 1 to 15; they were kept in pill-boxes till October 2, when the experiment was made. (Later on perfectly fresh pollen was experimented with, and found to be equally good, so that it appears unnecessary to dry it. One of the *Compositæ* was used, stained with fuchsin—a granule in methylated spirit.) They were shaken on to a slip and scraped with a needle to free the pollen; the debris other than pollen was removed with forceps, using the dissecting Microscope. The pollen was scraped into a heap on the centre of the slip and stained with methylated spirit, in which a few granules of methyl-violet had been dissolved. This stain must not be too dark; it should be quite transparent, though violet in colour. This process lasts about a minute, several drops being added at intervals, and the slip is then placed on the hot-plate. In the next process watch carefully to see that the liquid is in every case not completely evaporated. At the psychological moment add a drop of unstained spirit; repeat this, then add a drop of turpentine; repeat this three times, add a drop of balsam and xylol, and cover with the thin glass. The cover-glass should be placed on the edge of the slip, so as to be at the same temperature when it is placed on the balsam, and it is then less likely to hold air-bubbles. The slip will be dirty with stain and turpentine; this can be removed when the slide is cold with a rag dipped in spirit. When the cover-glass is on, extinguish the lamp, and let the slide cool with the hot-plate.

Bleaching Methods.‡—D. Carazzi considers that none of the bleaching methods associated with osmic staining are free from disadvantage. The chief drawback being the difficulty of counterstaining. Altmann's method is the simplest, and therefore the best. The slides with the blackened sections are placed over night in a 2 p.c. gold chloride bath. After washing and drying, the section is placed in a formic acid bath and exposed to direct sunlight. The reduced gold gives the section a purple colour, and the black colour has disappeared. The gold can now be removed by means of iodised alcohol.

* Zeitschr. wiss. Mikrosk., xxvi. (1910) pp. 530-2.

† Journ. Quekett Micr. Club, x. (1909) p. 471.

‡ Zeitschr. wiss. Mikrosk., xxvi. (1910) pp. 527-9.

Hydrogen peroxide as a bleaching agent has the disadvantage that it does not keep well. Potassium permanganate and oxalic acid are apt to injure the section unless carefully watched. Sodium perborate—commercially “oxylithe”—has been used by the author with good results. A saturated solution of this salt, to which has been added a small quantity of citric acid will bleach a section rapidly and without injury. Counterstaining is not attended with difficulty.

Chemical Basis of Gram's Method of Staining.*—M. Guerbet, A. Mayer, and G. Schaeffer consider that this staining reaction depends upon changes partly physical, partly chemical, which occur when an aniline dye is allowed to act upon a fatty acid. In a series of experiments they took fatty acids, saturated and unsaturated, simple and combined. They found that unsaturated acids and the lower saturated acids took the stain, but the higher saturated acids did not combine with the dye or with the halogen. Complex bodies, such as the cerebrosides, took the stain unequally. They consider that, in the case of the unsaturated acids, an additional product is formed which is imperfectly soluble in alcohol. In the case of saturated acids, a precipitation of colouring matter (modified, perhaps, by the halogen) takes place in the interior of the substance which has dissolved it.

It has been shown that microbes contain fatty granules, and the application of specific stains for fat show granules identical with those demonstrated by Gram's method. The authors further prove by their experiments that if bacteria normally Gram-stained are exposed to the action of a strong oxidising solution, the double bonds are chemically satisfied and the organisms are rendered Gram-negative. Also, if the procedure of Gram's method be reversed, the halogen stage preceding the aniline dye, no alcohol-fast product is formed.

Nile-blue Staining for the Demonstration of Metachromatic Granules.†—P. Eisenberg discusses the action of this stain upon the metachromatic granules of the *Bacillus pestis* and other micro-organisms. If the bacillus be stained with watery Nile-blue, the granules stand out as dark-blue spots on a lighter ground. On the addition of dilute soda, the granules become brownish-red, while the rest of the bacillus is usually pale orange. Fatty granules, on the other hand, usually take a pure orange-red colour, the tint of the pure Nile-blue base. The author believes that the brownish-red granules of the plague bacillus, like the metachromatic granules of the diphtheria bacillus, are hyperchromatic structures of the Babes-Ernst type. He points out, also, that granular appearances are often artificially produced by basic precipitation during the staining process.

Methods of Staining Glycogen.‡—P. Mayer describes a new method of glycogen-staining, and gives a comparative account of some other processes. Vastarini uses a mixture of 2 p.c. fuchsin and 4 p.c. resorcin in 94 p.c. alcohol. To this is added 4 p.c. hydrochloric acid. In some

* C.R. Soc. Biol. Paris, lxxviii. (1910) pp. 353-6.

† Centralbl. Bakt., 1^{te} Abt. Orig., liii. (1910) pp. 551-2.

‡ Zeitschr. wiss. Mikrosk., xxvi. (1910) pp. 513-22.

cases it is necessary to stain for 48 hours, but gentle warming will shorten the time required. This method is applicable to paraffin as well as to celloidin sections, but they must not be fixed to the slide with albumin or even with alcohol after Gaule's method. As a counterstain, light green or indigo-carmin may be used. As an alternative method Vastarini uses a creso-fuchsin and hæmatoxylin mixture. The author finds that by Vastarini's methods, glycogen is well and sharply stained, and the preparations do not fade quickly. On the other hand it may fail unaccountably.

Best's method is complicated, and the stock solution is difficult to prepare. It is also unstable. Gage stains the tissue with a fairly strong alcoholic solution of iodine, and by this means demonstrates glycogen as a homogeneous and not a granular substance. This is probably due to solution of glycogen by the iodine solution, and points to a defect in the method.

The author uses a ferric chloride and gallic acid ink, prepared according to a formula of Silbermann and Ozorovitz. Sections may be stained either after fixation to the slide or by immersion in the stain. To counteract simultaneous staining of the tissues, sections may be stained first in para-carmin. It is in this case necessary thoroughly to wash out the acid after this stain, in order to prevent subsequent precipitation of ink. Sections so stained have kept well for several months. The author claims for this method the advantage of simplicity over others described.

Further Note upon Injection Methods.*—B. Možejko, in a post-script to his previous account of the application of injection methods to the study of anatomical detail, points out that, for the demonstration of the circulatory system in certain classes of animals, it is advantageous to postpone injection almost until decomposition commences. This is the case in Vermes, Gastropoda and Crustacea among the Invertebrates. In Vertebrates the problem is complicated by the elasticity of the arterial walls, and the coagulation of the blood which accumulates in the venous system. In dealing with the former difficulty the author first of all made trial of amyl-nitrite, according to the method of Oviatt and Sergeant, but found it unsatisfactory. He now uses a peptone solution, with better effect.

For the injection of arteries the best time is just the moment when rigor mortis has passed off; the tissues are still fresh but the arterial walls no longer resist the passage of the injection material. It is, however, well to delay injection of the venous system until decomposition has commenced. The blood clots are then partly or wholly liquefied. The author obtained some of his best results by injecting reptiles (lizards and crocodiles) two or three days after death.

Staining Embryonic Nerve-tissues.†—In an investigation of the development of the autonomic nervous mechanism of the alimentary canal of the bird, Williamina Abel made use of Ramon y Cajal's silver-nitrate method. This method consists in impregnating the tissue with

* Zeitschr. wiss. Mikrosk., xxvi. (1910) pp. 542-7.

† Proc. Roy. Soc. Edin., xxx. (1910) pp. 334-6.

a silver salt and subsequently exposing it to the action of a reducing agent. After a number of experiments, it was found that while, in the case of chicks of two or three days' incubation, the best results were obtained with perfectly fresh tissue, a certain amount of post-mortem change was an advantage in older embryos, the optimum period varying from 12 hours in the case of a four-day chick to 24 or 36 hours in the case of adult animals.

By this method fully-developed nerves are stained dark brown, almost black, while the rest of the tissues are golden yellow. Nerve-fibres stain better than nerve-cells. In embryonic tissues, developing nerves are stained in accordance with their degree of development. In preparations stained by this method, nervous tissue, in addition to its dark tint, shows a peculiar sheen which differentiates it from deeply stained portions of non-nervous tissue. Many sections show signs of deterioration after a lapse of about two years.

Studying the Morphology of the Blood of Amphibia.*—F. Freidsohn exposed the slides to be used to the vapour of pure formalin for 2 minutes, then made a smear in the usual way, and again exposed to formalin vapor, this time for about 1 minute. Osmic acid vapor did not yield good results. The fixed smears were air-dried and stained as follows: To 50 c.cm. of distilled water were added fifteen drops of Giemsa stain and five drops of 2 p.c. aqueous eosin solution (extra B.A.)—this was allowed to act for from 1 to 2 hours. The preparations were then washed with water, dried and mounted. The author's observations are confirmatory of the view that the red and white corpuscles develop from lymphoid cells; the illustrations in regard to the polymorph leucocytes are specially convincing.

Studying the Varicosities on Non-medullated Nerve-fibres.†—A. Nemiloff first treated the fresh material in $\frac{1}{2}$ to $\frac{1}{10}$ p.c. solution in 1·6 p.c. saline; after allowing the stain to act for $\frac{1}{2}$ to 1 $\frac{1}{2}$ hours the preparations were fixed in 8 to 10 p.c. molybdate of ammonium, to which a few drops of formalin or of osmic acid solution were sometimes added. After fixation the preparations were washed in water, rapidly dehydrated in absolute alcohol, cleaned in xylol, and mounted in Damara.

Cell Inclusions in Rabbit's Liver.‡—L. Launoy observed certain protoplasmic inclusions in the liver of the normal rabbit by means of the following procedure: When the liver-cells are dissociated in a solution of brilliant cresyl-blue ($\frac{1}{10000}$ to $\frac{1}{20000}$), the presence of certain inclusions may be seen, and also at the periphery some hard, highly-refracting, often pigmented, yellow or yellowish-brown bodies, which stain blue. Treated with the sulphate of Nile blue ($\frac{1}{1000}$ to $\frac{1}{3000}$) and naphthol blue ($\frac{1}{2500}$), these granules stain blue or reddish violet respectively. The staining is selective, as no other intracellular granules are stained under the same conditions. The granules are insoluble in alcohol and chloroform in presence of acetic acid; osmic acid is feebly

* Arch. Mikrosk. Anat. u. Entwickl., lxxv. (1910) pp. 436-72 (1 pl.).

‡ Tom. cit., pp. 567-9 (1 pl.).

† Comptes Rendus, cl. (1910) pp. 145-8 (2 figs.).

reduced, and only at their periphery. The sections depicted in the illustrations were stained by the iron-alum method. The author arrives at the conclusion that the granules are neither fatty nor mitochondria, and calls them pigmented liquid bodies.

Vital Staining of Trypanosomes.*—A. Policard places between slide and slip a drop of infected blood, and then applies to the edge a drop of strong neutral red, dissolved in saline solution. By this method certain granules are stained a brick red. The chemical nature of these formations is doubtful, but they are not acid and are not degeneration products.

Golgi's Method for Examining the Internal Network of Spinal Marrow Cells.†—R. Legendre found that Golgi's method for examining the cells of the spinal cord could be advantageously modified by the following technique: The material was fixed in Golgi's fluid—i.e. formol (20 p.c.) 30, saturated solution of arsenious acid 30, alcohol (96 p.c.) 30, for 6 to 24 hours. Then nitrate of silver (1 p.c.) for one to several days. After a rapid wash in distilled water, the preparations were placed for 1 hour in the reducer (hydroquinine 20, sulphite of soda 5, formalin 50, distilled water 1000). This was followed by washing in distilled water, alcohols, paraffin sections. In this procedure all the later reactions suggested by Golgi are suppressed, as it was found that the foregoing method gave better results and clearer pictures of the network.

Staining Sections by the Romanowsky Method.‡—F. A. McJunkin describes a procedure by which the Romanowsky stain and its modifications may be used for staining sections. The sections are placed in the solution and incubated at 35° for 80 minutes, the solution being renewed at the end of 40 minutes. They are then washed in water, and, if quite blue, in 1:1000 acetic acid until pink; after this they are immersed in 2 p.c. tannin solution for 10 to 40 minutes. The tannin is washed off in water, the excess of water removed with blotting-paper, and then the preparation is hurriedly passed through absolute alcohol to xylol, and mounted in balsam.

(5) **Mounting, including Slides, Preservative Fluids, etc.**

Fixation of Celloidin Sections.§—D. Carazzi points out that the fixation of thin celloidin sections, of a thickness of 10 μ or less, to the slide, is a matter of difficulty, and one that requires strict observance of technical details. He gives an account of the Italian method of Brazzola and others, and of the Russian method of Rubaschkin.

The technique of the Italian method is as follows: The knife is kept moist with 70 p.c. alcohol. The sections as they are cut are transferred to a square piece of thin unglazed paper. They are dried with Swedish filter paper, and then the slide, coated with albumin-glycerin, is applied with gentle pressure. Paper and glass are reversed, douched with 95 p.c.

* C.R. Soc. Biol. Paris, lxxviii. (1910) pp. 505-7.

† Anat. Anzeig., xxxvi. (1910) pp. 207-17 (6 figs.).

‡ Michigan Acad. Sci., 11th Rep., 1909, pp. 110-11.

§ Zeitschr. wiss. Mikrosk., pp. 533-41.

alcohol, and then the paper is removed carefully. If the right conditions of moisture are present, the sections should now adhere to the glass. If the block is already stained, the sections may now be cleared with cresote, treated with xylol and mounted in balsam. Otherwise it is necessary to apply descending alcohols, stain, dehydrate, and mount as usual.

Rubaschkin's method consists essentially in removing the section straight from the razor to a slide prepared with albumin glycerin. He lays stress on the importance of arranging the section smoothly upon the slide. The section is then cleared with a mixture of equal parts of clove oil and aniline oil.

The author has made a comparison of the two methods, and considers the former to be more suitable when a large number of sections are to be dealt with, the latter more suitable for a small number. When it is necessary to stain the sections, he considers it likely that Favaro's modification of the Italian method would be satisfactory, but disclaims personal experience of it. In this process the sections are stained while still on the glazed paper and before fixation to the slide.

Mounting Spider Dissections as Microscopical Objects.*—The following method of sealing a mixture of equal parts of glycerin and spirit, a medium of great value in the mounting of the palpi of spiders, can be strongly recommended. Slides so prepared have stood the test of hard wear for more than two years, and show no signs of deterioration.

A tin cell is smoothed on both sides with fine emery cloth. It is cemented to a perfectly clean slip with good gold size and set aside until hard. The edge of the cell is painted with Miller's caoutchouc cement, which is allowed to become "tacky" but not dry. The medium and object are introduced, a cover placed in position, and a clip added. The whole is now *well* washed to remove all glycerin, and the clip is then removed under water. A little water will enter the cell, but this is no disadvantage. The slide is then wiped dry as far as possible, the remaining moisture allowed to evaporate, and a ring of gold-size painted on. In a day or so a ring of club-black is added, which completes the process.

Since this method was published, F. P. Smith says he has had several complaints as to the difficulty of obtaining Miller's cement, and that "C. R. Percival, the well-known mounter, to whom I communicated this method some years ago, tells me that he has used as a substitute an india-rubber cement supplied by Grübler, with complete success."

(6) Miscellaneous.

Filtration of Immune Sera.†—E. H. Ruediger finds that serum, after being centrifuged for 30 minutes at a speed of 3000 revolutions per minute, will pass without clogging through a Berkefeld filter, N or W. If, however, the serum be not quite cleared by the centrifugalising, it is well to pass it first through the coarser Berkefeld V filter. The centrifuge removes blood corpuscles, precipitates, and other extraneous matter.

By experiments with anti-tetanic and typhoid agglutinating sera, the author found that no appreciable loss in potency was caused by filtering.

* Journ. Quekett Micr. Club, x. (1909) pp. 473-6.

† Philippine Journ. Sci. Manila, iv. (1909) pp. 333-40.

He found, also, that the fine Berkefeld W filter stopped all bacteria, when subject to a pressure of not more than two atmospheres.

The author emphasizes the importance of washing, scrubbing, and boiling the filter after use in order to prevent subsequent clogging.

Indian-ink Method of Demonstrating *Spirochæta pallida*.* — Fröhwald used the following technique: the surface of the lesion is scraped until a drop of serum is obtained; a loopful of this is mixed on a slide with a drop of commercial indian ink (Günther and Wagner's). The mixture is then spread with the edge of a coverslip, after the manner of a blood-film. When dry the smear is examined with an oil-immersion. The spirochætes are seen as bright spirals on a dark brown field, and *pallida* can be distinguished from other spirochætes by its form. By this method the author claims that *Spirochæta pallida* can be demonstrated more quickly than by any other procedure.

New Drop Bottle.—F. R. Chopping showed at the Meeting held on April 20 a drop bottle which has been designed to hold staining reagents.

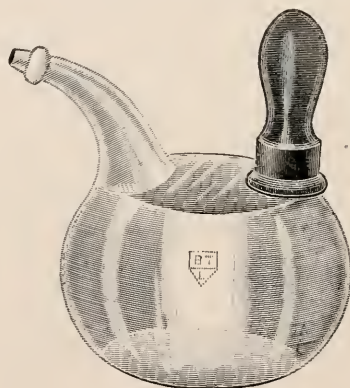

FIG. 51.

It is a modification of "Schuster's Alkalimeter"; the glass stopper is replaced by an indiarubber teat; manipulation of this produces anything from a fine steady stream for washing over slides to a single drop for staining purposes. The bottle holds rather more than the alkalimeter, and has been made in squat form with a wide base, giving it great stability, which experience has shown to be very desirable. A special advantage is that it can be used with equal facility with either hand (fig. 51).

The appearance is neat and the price moderate: the bottles shown were made by Messrs. Baird and Tatlock (see post, p. 397).

* Münch. Med. Wochenschr., No. 49 (1909).

Metallography, etc.

Properties of Gold Leaf at High Temperatures.*—J. C. Chapman and H. L. Porter have found that gold leaf does not become transparent when heated alone. When gold leaf, suspended from a horizontal wire and maintained in tension by means of a small weight hung on it, was heated, a gradual increase of length took place up to about 170° C. From 170° to 340° C. the length remained constant, and at 340° C. a rapid contraction began and continued through a considerable temperature interval. Gold leaf fixed to glass remained unchanged when heated a few degrees below 340° C., but when heated a little above 340° C. it became transparent. Microscopic examination showed that the gold itself was still opaque, but had aggregated, leaving clear spaces, as observed by Turner.† The contraction appears to be the cause of the transparency.

Microstructure of Copper.‡—A metallographical study of copper containing various amounts of impurities forms part of an investigation of the oxidation refining process by W. Wanjukoff. The samples were taken at different stages in the refining operation. Four etching reagents were used: (1) Ammonia solution; (2) ammoniacal solution of copper chloride; (3) nitric acid of 1.2 sp. gr.; (4) copper sulphate solution, acidified with sulphuric acid, in which the section was made the anode of a weak electric current. Numerous photomicrographs illustrate the paper.

Copper-aluminium Alloys.§—M. Barrée has determined the transformation points of the alloys in the range 8 to 15.5 p.c. aluminium, by measuring the variation of electrical resistance with temperature. Critical points were found in the neighbourhood of 500° and 750° C., sufficiently near to those found by L. Guillet. In addition, a new critical point was observed at about 200° C. In those cases in which the transformation did not occur at exactly the same temperature on heating and on cooling, the critical point on cooling was the lower. Successive heatings did not affect the position of the critical temperatures.

W. Broniewski|| has determined the specific conductivity, the temperature-coefficient of the resistance, the thermo-electric properties and the solution E.M.F. of the complete series of alloys of aluminium with copper. The curves embodying the results obtained point to the existence of the compounds Al_2Cu , $AlCu$, Al_2Cu_3 , and $AlCu_3$. Of these, Al_2Cu_3 is new, while the existence of $AlCu$ has been disputed.

Alloys of Nickel and Copper.¶—E. Vigouroux has not succeeded in isolating any definite compounds by the chemical treatment of nickel-copper alloys. An investigation of the E.M.F. of solution of these alloys leads to the same conclusion, that no compounds exist.

* Proc. Roy. Soc., Series A, lxxxiii. (1909) pp. 65-8 (2 figs.).

† See this Journal, 1909, p. 117.

‡ Metallurgie, vi. (1909) pp. 749-59, 792-801 (55 figs.).

§ Rev. Métallurgie, vii. (1910) pp. 16-33 (8 figs.).

|| Comptes Rendus, cxlix. (1909) pp. 853-5.

¶ Tom. cit., pp. 1378-80.

Alloys of Cobalt.*—F. Ducelliez has determined the E.M.F. given by binary alloys of cobalt with tin, antimony, bismuth, lead, and copper, in a solution of cobalt sulphate, against cobalt, and also against the other metal of the alloy. The compounds CoSn , CoSb , and CoSb_2 (?) are indicated by the curves given. Compounds do not occur in the other systems.

Phosphides of Tin.†—P. Jolibois has made a microscopical and chemical examination of alloys of tin and phosphorus containing 1 to 40 p.c. phosphorus. To obtain alloys containing more than 13 p.c. it was necessary to heat tin and phosphorus together under pressure. The mixtures were heated in sealed tubes at 620°C . Sn_4P_3 , microscopically observed as large hard needles in the alloys of lower phosphorus content, and SnP_3 , were the only compounds found. The numerous compounds of different formulæ described by other workers do not exist.

Phosphides of Nickel.‡—P. Jolibois, by dissolving nickel in a mixture of tin with Sn_4P_3 , has obtained the compound NiP_2 . When nickel was dissolved in a mixture of Sn_4P_3 with SnP_3 , the compound NiP_3 was obtained.

Effect of Compressing Mixtures of Metals.§—G. Tammann has compressed mixtures of filings of two metals at a pressure of 5000 atmospheres. The blocks obtained were examined microscopically, and their behaviour on heating and their electrical conductivity investigated. It was found that the formation of solid solutions or compounds could not be brought about by pressure alone, for the blocks, immediately after compression, consisted of the unchanged metals lying side by side. Diffusion may go on in the cold, and is accelerated by raising the temperature. In a compressed mixture of bismuth and thallium, mixed crystals as a blue fringe between the metals can be seen after 5 hours at 120°C . The compound Bi_3Tl_2 is formed at higher temperatures.

Shrinkage of Metals and Alloys.||—F. Wüst has devised an accurate method of determining the alteration in length of a cast bar as its temperature falls from the solidifying point. An iron rod projected into each end of the mould in which the bar was cast. These rods, co-axial with the bar, were attached to small hydraulic cylinders, arranged in such a manner that variation in length of the bar caused an alteration in level of water in a capillary tube. From the time of casting of the bar, observations of time, temperature and length were taken, and plotted as time-temperature and time-length curves. The temperature-shrinkage curve was obtained from these. A description of the microscopical structure of each casting is given. The shrinkage of lead, tin, zinc, aluminium, copper, bismuth and antimony, and of a number of alloys of these metals and of nickel, was determined. The shrinkage coefficients experimentally obtained were found to differ notably from those calculated from

* Comptes Rendus, cl. (1910) pp. 98–101 (5 figs.).

† Op. cit., cxlviii. (1909) pp. 636–8.

‡ Op. cit., cl. (1910) pp. 106–8.

§ Zeitschr. Elektrochem., xv. (1909) pp. 447–50; through Journ. Chem. Soc., xcvi. (1909) p. 669.

|| Metallurgie, vi. (1909) pp. 769–92 (82 figs.).

published coefficients of expansion. An alloy of components completely insoluble in each other in the solid state contracts less than either of its components; the eutectic alloy having the smallest shrinkage-coefficient. An alloy consisting of one or more solid solutions contracts more than either of its components. Neither in metals nor alloys could a definite relationship between shrinkage and melting point be discerned.

Metastability of Metals.*—E. Cohen and K. Inouye find that other metals exhibit phenomena resembling those observed in connection with the "strain-disease" of tin. Pieces of hard-rolled thin sheet of the metals (lead, copper, zinc, nickel, bismuth, brass) were etched with some figure, such as a cross, placed in contact with similar but unetched pieces between two iron plates, and heated for a number of hours at constant temperatures, for instance, 100° C. or 180° C. In many cases the unetched strip was "infected," and showed a figure similar to that etched on the piece with which it was in contact. The inoculation did not occur in the cold. From these and other observations the authors infer that the common metals, as usually employed in a mechanically strained condition, are metastable, and may pass into a more stable form through inoculation as well as by heating.

Crystalline Structure of Iron at High Temperatures.†—W. Rosenhain and J. C. W. Humfrey have made some preliminary experiments on the microscopical effects of strain in iron at high temperatures. A polished strip of sheet iron was heated in a high vacuum; it was held in such a manner that the release of a strong spiral spring, by electrical means, caused a pull on the specimen sufficient to deform it. The iron strip was strained when the temperature at its centre exceeded 1000° C., the ends not being visibly red. When cold, the specimen was examined microscopically. In a similarly heated but unstrained specimen, three regions of different appearance were noted. At the ends the surface was unchanged. Where the temperature approached redness, a system of interlacing black lines was seen, and in the central (hottest) part, a faint tinting, apparently caused by slight oxidation, revealed a new crystallisation, of coarser and more regular structure, characterised by numerous examples of twinning. Upon these appearances were superposed, in the strained specimen, the effects of deformation. While the area of medium temperature, characterised by the interlacing black lines, showed no signs of plastic deformation, the neighbouring regions, both cooler and hotter, showed slip-bands and other clearly marked strain effects. The authors identify the three regions with the α , β , and γ forms of iron, and consider that the absence of strain effects in the region corresponding to the β form, indicates the greater hardness of this allotropic modification. The interlacing black lines noted in this region are held to be caused by a volume change occurring when α changes to β and β to α , this volume change producing relative movement of the crystals. An approximate measurement of the temperature of different points in a heated and strained specimen was made by

* Zeitschr. Phys. Chem., lxxi. (1910) pp. 301-11 (3 figs.).

† Proc. Roy. Soc., Series A, lxxxiii. (1910) pp. 200-9 (5 figs.).

previously placing particles of salts of known melting points on the rear surface of the specimen. An examination of the particles when cold, revealed whether they had melted or not.

"Growth" of Cast Irons after repeated Heatings.*—H. F. Rugan and H. C. H. Carpenter have made extensive experiments on different commercial cast irons and on numerous alloys containing varying amounts of carbon and silicon, to ascertain the cause of the familiar phenomenon of growth. Long continued heating is not accompanied by continuous growth; successive heatings and coolings are necessary for growth to take place. White irons of low silicon content altered in volume very little in repeated heating and cooling, while cast irons containing notable amounts of silicon, and accordingly grey, increased in volume in some cases more than 60 p.c. The exclusion of gases, by carrying out the repeated heatings in a vacuum, prevented the growth of some specimens, but others still gave some increase of volume. In these cases the growth is ascribed to the effects of the gases originally present in the metal. A theory of the mechanism of growth is outlined; the following are the chief points: Commercial grey iron consists essentially of a solid solution of iron silicide in iron, intermingled with which is a quantity of graphite. Heating in air or in flame gases, leads to a penetration of gases, which, probably on cooling, are absorbed by the solid solution and oxidise the silicide of iron. This oxidation is accompanied by an increase of volume, causing incipient disintegration and probably driving the graphite into holes originally present in the metal. A second heating brings about further gas absorption, and the reaction proceeds through numerous heatings until the whole of the silicon and some of the iron are oxidised. The metal has now lost the mechanical strength of cast iron, and can be sawn like chalk; its microstructure has been revolutionised.

Iron-carbon Alloys.†—N. Gutowsky has sought to determine accurately the solidus curve of this system—the temperatures at which solidification is complete on cooling, or at which melting begins on heating. While the temperatures of commencing solidification and the eutectic temperatures were clearly indicated in cooling curves taken by the author, the points of final solidification could not be discerned in alloys not containing eutectic. For this reason, and also because of the difficulty of ensuring complete equilibrium in a solidifying alloy, the cooling-curve method was abandoned in favour of the method of examining microscopically alloys after quenching at known temperatures, the samples being previously annealed to bring them into a condition of equilibrium. The solidus curve thus obtained for the range, 0 to 2 p.c. carbon, is considerably more concave than that given by Heyn and others, the temperatures at which melting begins, in intermediate compositions, being lower than the temperatures formerly assumed. A series of cementation experiments, and a study of the phenomena of melting and solidification of white and grey iron, were also carried out.

* Journ. Iron and Steel Inst., lxxx. (1909) pp. 29–143 (15 figs.).

† Metallurgie, vi. (1909) pp. 731–6, 737–43 (35 figs.).

Hardness of Quenched Steels.*—A. Portevin and H. Berjot have employed the Shore scleroscope and to a smaller extent the Brinell ball, to determine the hardness of two steels containing 0.32 and 1.46 p.c. carbon, a steel containing 0.56 p.c. carbon, 1.46 p.c. silicon, and two case-hardened steels originally containing, the one 0.13 p.c. carbon, the other 0.09 p.c. carbon, 2.54 p.c. nickel. Specimens were tested after hardening at different temperatures, and after hardening and reheating to different temperatures for various lengths of time. The indications of the scleroscope are rendered worthless by the presence of hardening cracks or of a superficial decarbonised layer. If proper precautions are taken, the scleroscope may safely be used for measuring the hardness of quenched steels, and is especially suitable for testing case-hardened steels, giving as it does the superficial hardness which cannot be determined by the Brinell method. The measurement of depth of cementation by the appearance of the fracture, is less reliable than measurement by microscopic examination of a polished and etched section.

Cementation of Silicon Steels.†—L. Grenet has made comparative cementation tests on a mild case-hardening steel and a steel containing 3.2 p.c. silicon, 0.05 p.c. carbon. No cementation of the silicon steel took place in wood charcoal, but in potassium ferrocyanide 1 p.c. carbon was absorbed by the outer layer 0.5 mm. thick, during a 6 hours' heating at 950° to 1000° C. No graphite was found in the cemented silicon steel after slow cooling.

Carbon-tungsten Steels.‡—T. Swinden has studied the micro-structure of three steels containing 0.57, 0.89 and 1.24 p.c. carbon, and about 3 p.c. tungsten, quenched and air-cooled from different temperatures. Some measurements of electrical resistance were made. Conclusions drawn from earlier work § were confirmed. The lowering of the A_{r1} point by high initial temperature does not appear to be due to the formation of a carbide of tungsten, or a double carbide. Possibly a compound Fe_3W goes into solution at the "lowering temperature," and is reprecipitated at the low point on cooling.

Magnetic Properties of Alloys of Iron.¶—C. F. Burgess and J. Aston have made magnetic and electrical tests of two series of alloys, iron-nickel and iron-copper, prepared from electrolytic iron, and containing very small percentages of impurities. The possible occurrence of the compound Fe_2Ni is indicated.

Effect upon Steel of Sudden Changes of Temperature.¶—B. Zschokke ascribes the cracking of a tank, constructed of mild steel plate, to the frequent rapid heating of the internal surface when the tank was used for the preparation of a solution of caustic soda. Numerous experiments

* Rev. Métallurgie, vii. (1910) pp. 61-75 (4 figs.).

† Comptes Rendus, cl. (1910) pp. 921-2.

‡ Journ. Iron and Steel Inst., lxxx. (1909) pp. 223-56 (41 figs.).

§ See this Journal, 1907, p. 640.

¶ Met. and Chem. Engineering (formerly Electrochem. and Met. Ind.), viii. (1910) pp. 23-26, 79-81 (11 figs.).

¶ Rev. Métallurgie, vii. (1910) pp. 165-82 (24 figs.).

on the effect of rapid heating and cooling of various metals are described. Quenching lines were produced on the surface of mild steel specimens by a rapid cooling from temperatures below 400° C. Cracks were not obtained either by quenching or rapid heating.

Importance of Metallography in the Iron Industry.*—P. Oberhoffer indicates the various directions in which the Microscope may be applied to practical advantage in the iron and steel industry. Photo-micrographs illustrating the effect of silicon, phosphorus, and manganese upon size of grain, the changes in structure brought about by heat treatment, the effects of segregation, and other structural features, are given. Further examples are given by E. Heyn,† who also reviews briefly the progress of metallography in Germany.

Cementation by Solid Carbon.‡—G. Charpy and S. Bonnerot have obtained purely negative results in attempting the cementation of a mild steel with sugar carbon, graphite, and diamond, in the total absence of gas. The metal and the carbon were first heated to 1000° C. in separate tubes, in a vacuum continuously maintained, and were placed in contact after cooling. The temperature was raised to and maintained at 700° C. in a vacuum, till no more gas could be extracted, and was then kept at 1000° C. for several hours. Microscopic examination of the surface of the steel showed that not the least trace of carbon had been absorbed. The presence of traces of gas was found to bring about cementation with each of the three forms of carbon.

It now becomes necessary to ascertain if the diffusion of carbon in the interior of cast iron and steel is in any way connected with the presence of occluded gas.

Composition of Mixed Crystals in Alloys.§—D. Mazzotto describes a new method for determining the composition of mixed crystals deposited by alloys at different temperatures, based on a knowledge of the heats of fusion of the mixed crystals. The method is applied to the following binary systems:—lead-tin, tin-zinc, tin-bismuth, bismuth-lead.

Sintering-point Curve.||—The sintering-point of a binary mixture is the temperature at which the eutectic begins to melt, and is readily observed. A. Stock points out that the sintering-point curve of a binary system may be used to determine the composition of any chemical compounds formed. The curve shows a sharp cusp directed upwards at the composition corresponding with a compound.

* Stahl und Eisen, xxx. (1910) pp. 239-43 (27 figs.).

† Tom. cit., pp. 243-6 (3 figs.).

‡ Comptes Rendus, cl. (1910) pp. 173-5.

§ Nuovo Cim., xviii. (1909) pp. 180-96, through Journ. Chem. Soc., xvi. (1909) pp. 1008-9.

|| Ber. Deutsch. Chem. Ges., xlii. (1909) pp. 2059-61.

PROCEEDINGS OF THE SOCIETY.

MEETING

HELD ON THE 20TH OF APRIL, 1910, AT 20 HANOVER SQUARE, W.,
E. J. SPITTA, ESQ., M.R.C.S., ETC., VICE-PRESIDENT, IN THE
CHAIR.

The Minutes of the Meeting of March 16th, 1910, were read and confirmed, and were signed by the Chairman.

The List of Donations to the Society received since the last Meeting was read as follows, and the thanks of the Society were voted to the donors :—

Vincenzo Patella, La Genèse Endothéliale des Leucocytes } Mononucléaires du Sang. (Svo, Sienne, 1910) }	From <i>The Author.</i>
Sir William Huggins, The Royal Society. (Svo, London) ..	<i>The Author.</i>

The Chairman, in reference to this donation from Sir William Huggins, said that Sir William was one of the oldest Fellows of the Society, having been elected in 1853. Seeing his great age he felt sure those present would like to offer the donor their warmest congratulations upon the health and energy necessary to enable him to add yet another volume to the already numerous contributions to science from his pen. The Chairman added it had been his privilege, when living near Tulse Hill, to know Sir William very intimately, and that he had told him that it was his intention at one time to have taken up microscopy as his special study, but that the spectroscope had attracted him from the subject. In one sense all present must feel this was a loss to the Society, for it was impossible to resist the feeling how much our subject might have advanced if its treatment had in any way been commensurate with that given by Sir William to this instrument, which had brought about—as everyone knew—discoveries of such a far-reaching nature. The Chairman then concluded by adding he had brought the matter especially before the Meeting because he felt those present might much like not only to pass the ordinary vote of thanks to the donor, but that it should be accompanied by a special resolution conveying their warmest congratulations to Sir William on his apparent health and vigour.

The motion was put to the Meeting, and carried by acclamation.

Dr. Hebb said that there were several interesting items sent for exhibition that evening. Among these exhibits were two by Mr. Chopping, Assistant in the Clinical Laboratory of Westminster Hospital. The first of these were samples of "Solmedia," i.e. Solid

Media. These were shown in the dry or raw form, also when made up, and thirdly with bacterial growth. The other exhibit was a drop-bottle for reagents of all kinds; it is a modification of Schuster's alkalimeter.

Dr. Hebb called the attention of the Fellows to the oilcan of a typewriter; this he said would be found very useful both for laboratory work and for travelling purposes. The other matter was a slide showing Spirochaetes demonstrated by the Indian ink method. The method already had a considerable vogue, and might possibly supersede the dark-ground illumination method, though the latter had the advantage of dealing with living organisms.

The Chairman thought the oiler was simple and effective, and if made of some softer material than tin would be useful to both classes of men—those who oiled the cover-glass and those who oiled the objective.

Mr. Wesché said he had one of the ordinary kind which he only used about once in six months, and then it took him about half an hour to get the outer cover off.

Mr. F. Shillington Scales said that the method of dark-ground illumination had proved of much service in demonstrating *Spirochæta pallida*, and was now a recognised method of diagnosis, and it would be interesting to know if the method of preparation now before the Meeting could demonstrate the presence of this and other Spirochaetæ with equal facility and readiness. If so it would be of no little value.

Mr. J. E. Barnard thought it was doubtful in the case of a mixture from the mouth to say with certainty what were there.

The Chairman said the great advantage appeared to be that here they had a method which required very little preparation to employ it, which in a laboratory was no doubt a valuable thing.

Dr. Hebb said this was so: all they had to do was to take a match, dig it into a hollow tooth and put the result on a slide, take an equal quantity of Indian ink and mix the two together; then make a smear after the manner of making a blood-film, i.e. by dragging the mixture across the long surface of the one slide by means of the short side of another. When dry the film could be examined at once, and in this way the Spirochaetes were demonstrable in a few minutes.

The Chairman said that one point must not be overlooked: it was that organisms seen by this method were necessarily dead, but that with the dark-ground illuminator they were to be seen in their natural and living state. For purposes of investigation this was a factor not to be hastily overlooked, but that for the rapid requirements of the clinical laboratory the method was apparently one of the most valuable he had seen in recent times and remarkably simple to carry out, without too, any special apparatus whatever.

Dr. Hebb said that *Spirochæta pallida* was stated to have a very distinctive and peculiar movement.

Mr. J. E. Barnard said it did not have the gyrating movement seen in other kinds—when they got it in a particular plane the spiral movement could be seen, and then when it was seen "end on" it was more of an undulatory motion.

Mr. J. W. Ógilvy said that *Spirochæta pallida* had more twists in it and was of a finer structure than *dentium*. He had taken photographs

of a living *pallida*, but to do this properly a reflex camera would be required; however, he had obtained one or two fairly good photographs.

The Chairman said that anything of a labour saving nature was of value he felt sure all would allow, but one so simple as had just been mentioned commended itself very strongly, and he felt sure those present would be desirous to thank Dr. Hebb for bringing the matter before their notice, and he felt equally certain the Meeting would like to convey their congratulations to Dr. Burri for his simple, useful, and ingenious method.

Dr. Hebb said they ought to thank Mr. Chopping instead, as what had been shown was entirely due to his energy and ingenuity.

Mr. O. W. Wentz exhibited some transparent specimens of animal substances prepared so as to show the internal structure without the removal or alteration of the exterior. A bone, a crayfish, a mouse and other objects so treated were exhibited to the Meeting.

The Chairman thought that these were very beautiful as museum specimens, but being in liquid they could not safely be handed round for inspection.

Mr. W. R. Traviss exhibited and described a small iris-diaphragm to be applied to high-power objectives—the one shown being made to suit Leitz' high-power objectives so as to regulate the size of the aperture as might be required. It could be made to suit any maker's objectives where they mount the optical system in one part, as in Continental powers. The iris-diaphragm can be made very short to suit medium high powers when used for the Binocular.

The Chairman said that Mr. Traviss had very kindly sent him one of these diaphragms to look at and try. It was certainly very useful for adaptation to Leitz' two-millimetre objectives, but he did not feel quite certain as to whether the results effected by its means were quite as good as when using the special diaphragm supplied by the makers. He thought the iris was a little too far off the back-lens, although, doubtless, that could very easily be altered.

Mr. Traviss explained that the first one was made by way of experiment, but in future they would be made to go nearly down to the lens.

Dr. Hebb read some portions of a paper by Mr. E. M. Nelson entitled, "What did our Forefathers see in a Microscope?"

Mr. F. Shillington Scales read a further paper by Mr. Nelson, "On Critical Microscopy," illustrated by a diagram showing the appearance of the back lens of an objective under different conditions.

Mr. A. E. Conrady said he had no doubt that this paper would be warmly welcomed by the younger members, as it supplied detailed and safe instructions for regulating the illumination of microscopic objects. The reference in the paper to the late Professor Abbe suggested some

thoughts on microscopical theories. It seemed difficult to understand at the present day why Abbe should have defended so persistently, and with his characteristic vigour, the use of small illuminating pencils; possibly the imperfections of the earlier objectives had something to do with it. There could be no doubt that, given objects and objectives which would bear it, the wide and well-centred illuminating cone had every advantage, for whilst a narrow oblique illuminating pencil would realise the fullest resolving power of an objective, it did so in one direction only. One might see delicate structure in one direction, whilst far coarser detail at right angles would be invisible. The wide axial cone, on the other hand, gave nearly the full resolving power attainable with oblique light, but gave it uniformly in all directions, so that all detail accessible to any particular objective was seen simultaneously. Another thought which occurred to him concerned theories in general. The conditions prevailing in ordinary circumstances of microscopical (and other) observations were far too complicated to admit of treatment even by present-day mathematics, and the first thing to be done in framing any theory consisted in eliminating the complications until the simplified conditions admitted of mathematical treatment. The result would be a theory which should be rigorously borne out by experiment, provided that the underlying assumptions were realised, but which might seriously disagree with the result of observations if the proper conditions were not fulfilled.

Mr. F. Shillington Scales was pleased to have heard the interesting remarks of Mr. Conrady, and he thought that, after all, the actual theory of the Microscope did not affect five-sixths of those who were Fellows of the Society, and still less other workers; what did affect them was the question of how to get the best results out of their Microscopes, and the important point was to get a true representation of the structure under examination. He thought that no one who had done really difficult work with the Microscope could have any doubt that Mr. Nelson's method was the correct one, and modern microscopy owed him a debt for his frequent enunciation of correct principles of working. Except by the use of large axial cones, well corrected, and bearing a definite ratio to the aperture of the objective used, it was impossible to obtain the full advantage of the fine objectives which the skill of opticians of the present day had given us, and Mr. Nelson had done more than anyone else to call attention to this. He was glad to find that Mr. Nelson laid stress upon the unreliability of bacteria as a test for objectives; anyone else who had had experience in testing objectives would be able to indorse this view.

The Chairman said they all knew Mr. Nelson well enough both by name as well as by his numerous contributions to Microscopy, but those who recollected his earlier writings would remember the severe attacks made upon him by his hasty critics when he advanced his views upon critical illumination. Well might he have told them to "wait and see," for they are certainly accepted by every thinking microscopist in the present day. They were glad to receive another paper touching upon this subject, and he felt sure the Members present would desire it to be recorded they were pleased once more to receive his communications, and to express the

hope he would not forget the Society though living now so far from London.

The thanks of the Society were unanimously voted to Mr. Nelson for his papers.

The following Instruments, Objects, etc., were exhibited:—

Dr. Hebb:—Samples of Solmedia: Agar-agar, Drigalski-Conradi, Sabouraud, Gelatine and Litmus Gelatine; and the following cultures on Solmedia: *B. typhosus* on Drigalski-Conradi; *B. coli* on ditto; *B. anthracis* on Agar-agar; *B. pyocyaneus* on ditto; *Streptothrix* W. H. on Glucose Agar; *B. typhosus* on Gelatin slope; Ditto on Gelatine stab; *B. coli* on Litmus Gelatine; A New Drop-bottle for Staining Reagents; An Oil-can for Cedar-wood Oil; Burri's Indian-ink Method for demonstrating Spirochætes, etc.

Mr. W. R. Traviss:—Small Iris Diaphragm applied to a high-power objective.

Mr. O. W. Wentz:—Transparent Zoological and Anatomical Specimens prepared according to Professor Dr. W. Spalteholz's process.

New Fellows.—The following were elected *Ordinary* Fellows of the Society:—Emily Mary Berridge, Edward Edwards Cox, Helen Charlotte Isabella Fraser, Robert Riddell, J. C. Sinha, Panks James Wigginton.

MEETING

HELD ON THE 18TH OF MAY, 1910, AT 20 HANOVER SQUARE, W.,
E. J. SPITTA, ESQ., L.R.C.P., F.R.A.S., ETC., VICE-PRESIDENT, IN
THE CHAIR.

The Chairman referred to the lamented death of His Majesty King Edward VII., the Patron of the Society, and said—

Ladies and Gentlemen,—I feel sure all those present will expect some remarks from the Chair respecting the terrible loss the Nation, whether considered individually or collectively, has suffered so recently in the death of our late most deeply beloved and greatly respected King—King Edward the Peacemaker of the World.

Owing to the unavoidable absence of the President, I have been asked as one of the vice-presidents, to take the responsibility of the Chair this evening, but I deeply regret it has not been placed in abler hands on this august occasion, for no one is more conscious than I am of my feeble ability to find words that will adequately express both my own feelings and those which I know lie deep in the hearts of you who are present, and also of those Fellows who are absent.

We have all read or heard from day to day so much about the late King that there is little left for me to add that is new. But some of you

may not be aware what a great interest he took in all things of a scientific nature, and especially anything that was new and epoch-marking in connection with the treatment of disease. Some years ago one can recollect the interest he showed when, as Prince of Wales, he was present at a Soirée of the Royal College of Physicians. Consumption was then first proved to be due to the ravages of a bacillus, and the lively enthusiasm he displayed when the actual bacilli were shown him under the Microscope cannot easily be forgotten. Still later, and in fact all through his career as King, this interest has never ceased, and has recently been particularly emphasized by his creation of a new appointment—that of Bacteriologist to the Royal Household—the first appointment of the kind in Europe. Yes, Gentlemen, our late King was a really wonderful man, who with all his manifold duties of state could find time to keep himself in touch with everything that was new. I recollect the late Sir William Huggins telling me that in ten minutes' conversation with His Majesty he was particularly struck with the pertinent questions he put to him upon the future possibilities of the spectroscope. You can well appreciate, Gentlemen, even from the little I have said, the truth in what I am about to say, that in losing King Edward VII. science has lost a valued supporter, and the only solace we can find in our poignant grief is the knowledge that his Son—His Most Gracious Majesty King George—is a monarch of like attainments. Long may he be spared to reign over us.

In conclusion, Gentlemen, I feel sure, without putting a resolution before you in the ordinary manner, you will consider your Council have acted rightly when they resolved that this Meeting “do adjourn as a mark of respect to our late Sovereign,” and that our Secretaries be requested to forward the two memorials about to be read to you: One to be addressed to His Most Gracious Majesty King George V., praying him to accept our heart-felt sympathy in this his great time of grief, assuring him of our respectful congratulations on his accession to the Throne, and of our loyal, humble, and faithful allegiance to him as King; and the other to our most beloved Queen-Mother Alexandra, expressing our deep condolence with her in her great bereavement, adding at the same time our trust that Almighty God may help her in this her pressing hour of need.

The Chairman then read the proposed Addresses, as follows:—

MAY IT PLEASE YOUR MAJESTY,

We, your Majesty's dutiful and loyal subjects, the President, Vice-Presidents, Council, Officers, and Fellows of the Royal Microscopical Society in General Meeting assembled, humbly beg leave to offer our sincere and respectful condolences to your Majesty on the loss which you and the Nation have sustained on the death of your illustrious Father, our late beloved Sovereign, whose many virtues, effective interest in scientific pursuits, and thoughtfulness for the benefit of his subjects, are universally recognised. The death of your Royal and Imperial Father touches this Society most acutely, as he was its Patron since its incorporation in 1866.

We desire also to present our humble and heartfelt congratulations upon your Majesty's accession to the Throne, and to express the hope that your Majesty's reign may be long, happy, and glorious.

That you may ever rule over an affectionate and grateful people, is the earnest wish and ardent prayer of your Majesty's loyal and dutiful subjects the Fellows of the Royal Microscopical Society.

MAY IT PLEASE YOUR MAJESTY,

We, the President, Vice-Presidents, Council, Officers, and Fellows of the Royal Microscopical Society, humbly implore leave to intrude upon your Majesty's sacred sorrow by giving expression to our grief at the death of our beloved Sovereign King Edward VII., the Patron of our Society. We humbly beg to offer our dutiful sympathy to your Majesty, and to assure you it is our heartfelt prayer that Almighty God will give you comfort in this your sad bereavement.

The Addresses were accepted in silence, and the Meeting was then adjourned until Wednesday, May 25, at 7 p.m.

MEETING

HELD ON THE 25TH OF MAY, 1910, AT 20 HANOVER SQUARE, W.,
A. N. DISNEY, ESQ., M.A. B.SC., VICE-PRESIDENT, IN THE CHAIR.

The Minutes of the Meetings of April 20 and May 18, 1910, were read and confirmed, and were signed by the Chairman.

The List of Donations to the Society received since the last Meeting, exclusive of exchanges and reprints, was read as follows, and the thanks of the Society were voted to the donors.

	From
British Antarctic Expedition, 1907-9. Vol. I., Biology } (4to, London, 1910) }	Sir Ernest H. Shackleton.
An Old Microscope }	Mr. C. F. Rousselet.
An Old Microscope, Culpeper and Scarlet Model }	Mr. A. Ashe.
Two Slides of Insects, mounted by the late B. F. } Quimby, of Chicago }	Dr. V. A. Latham.

Dr. Hebb said they had two papers for that Meeting, the first being by Dr. M. D. Ewell, "On Comparative Micrometric Measurements," and the second by Messrs. E. Heron-Allen and Arthur Earland, "On the Recent and Fossil Foraminifera of the Shore Sands of Selsey Bill, Sussex. Part V. The Cretaceous Foraminifera." These papers they would no doubt wish to be taken as read. On the motion of the Chairman this course was agreed to.

Dr. Hebb said he regretted to have to report the deaths of Professor Agassiz and Professor van Beneden, who were Honorary Fellows of the Society; also that of Sir William Huggins, who was one of their oldest Fellows, having joined the Society in 1853.

Mr. C. F. Rousselet read a description of two old Microscopes which had that evening been presented to the Society, one by Mr. Ashe and the other by himself. The first was one after the three-legged model first introduced by Culpeper and Scarlet early in the 18th century, but made by a later and unknown maker, all in brass, and to which at a still later date a rack and pinion had been added to the tube for focusing. The other old Microscope was a cheap imitation of the same model made after 1750 at Nürnberg in Germany, all in wood and cardboard; the specimen had formerly belonged to his great-uncle, and was in fact his first Microscope.

The thanks of the Society were voted to Mr. Rousselet for his paper.

Attention was called to two Slides of Insects exhibited under Microscopes in the room, presented to the Society by Miss Latham, M.D., of Chicago, one of which was a Bee, and the other a Croton Bug.

Dr. Hebb said he had received another letter from Mr. F. H. Baker, of New South Wales, who was desirous of exchanging specimens with Fellows of the Society. He offered the following Polyzoa: *Catenicella lorica*, *C. ventricosa*, *C. plagiotoma*, *Carbasea dissimilis*, *Amathia tortuosa*; Radulæ of *Chiton Novæhollandiæ*, *Phaseanella australis*, *Haliotis naevosa*, etc., in exchange for good mounts of marine Polyzoa, good shells of Cypræa, etc. He can send Polyzoa not mounted, if desired.

Dr. Hebb said he thought they ought to pass a vote of thanks to those gentlemen who had been able to come that evening in order to help make up a quorum. It was very necessary to hold the Meeting in order to elect those who had been proposed for the Fellowship of the Society at the Meeting in April, and also for other reasons.

The following Instruments, Objects, etc., were exhibited:—

The Society:—Two Slides, presented by Dr. Vida Annette Latham, that were mounted by B. F. Quirnby, of Chicago, about 1887—*Apis mellifica*, *Ectobia Germanica*. An Old Microscope, Culpeper-Scarlet Model, presented by Mr. Ashe. An Old Microscope, made at Nürnberg, presented by Mr. Rousselet.

New Fellows:—The following were elected *Ordinary* Fellows of the Society:—Messrs. James Grundy and Charles Herbert Higgins.

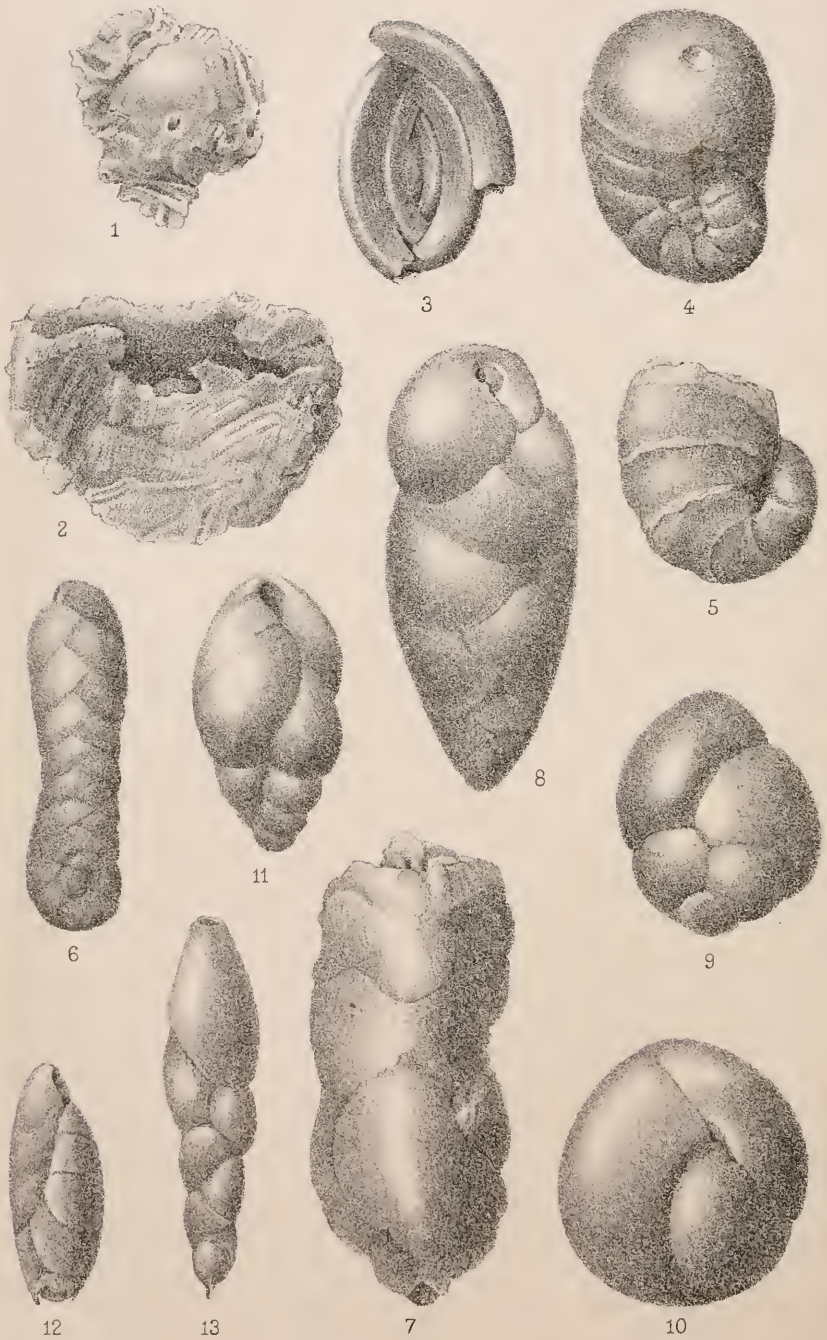

JOURNAL
OF THE
ROYAL MICROSCOPICAL SOCIETY

AUGUST, 1910.

TRANSACTIONS OF THE SOCIETY.

XI.—*On the Recent and Fossil Foraminifera of the Shore-sands of Selsey Bill, Sussex.*—V. *The Cretaceous Foraminifera.*

By EDWARD HERON-ALLEN, F.L.S., F.R.M.S.,
and ARTHUR EARLAND.

(Read May 25, 1910.)

PLATES VI.—XI.

WE have already, on more than one occasion, called attention to the presence, among the floatings and washings of Foraminiferous material from these sands, of a large proportion of fossil forms from the Upper Chalk.* It was not, however, until we had systematically examined gatherings from all points of the shore, and assisted Nature by breaking open some hitherto undamaged flint sponges found between tidemarks on the beach, that we

* See this Journal, 1908, p. 540 ; 1909, p. 307.

EXPLANATION OF PLATE VI.

- Fig. 1.—*Nubecularia lucifuga* Defrance. × 50.
" 2.—Ditto. Ditto.
" 3.—*Spiroloculina excavata* d'Orbigny. × 50.
" 4.—*Haplophragmium inflatum* Reuss sp. × 50.
" 5.—Ditto. Ditto.
" 6.—*Spiroplecta prælonga* Reuss sp. × 100.
" 7.—*Clavulina angularis* d'Orbigny. × 100.
" 8.—*Bulimina ovata* d'Orbigny. × 50.
" 9.—*B. pyrula* d'Orbigny. × 100.
" 10.—Ditto. Oral view. × 100.
" 11.—*B. elegans* d'Orbigny. × 100.
" 12.—*B. elegantissima* d'Orbigny. × 150.
" 13.—*Virgulina schreibersiana* Czjzek sp. × 150.

realised the variety and extent of these forms. The subjoined list of Chalk Foraminifera, comprising as it does no less than 118 species, contains, it will be observed, a very full and highly typical series of Upper Cretaceous forms. So varied indeed is this fauna that we have deemed it desirable to submit our specimens and lists to Mr. Joseph Wright, F.G.S., of Belfast, before submitting this paper to the Society as a not unimportant section of our work upon these shore-sands.

A certain number of the species have been pronounced by Mr. J. Wright to be new to the Chalk, being for the most part species which have hitherto been described as making their first appearance in geological time in Tertiary beds. In point of fact many of these were recorded by us, in the year 1894, from the Upper Chalk of the Twyford-Maidenhead Railway cutting,* and prior to that date many of these species had been recorded from the same locality by Mr. Frederick Chapman.†

Recent and Tertiary fossil specimens of many of these forms have already been recorded by us in the preceding papers of this series; and when this is the case, we have thought it expedient to preserve in the subjoined list the consecutive number under which it was originally described. The whole of the described species will, however, be co-ordinated with proper reference numbers in the analytical table which will conclude this series of papers, when the supplement now in course of preparation has appeared in this Journal.

As the paper on the Twyford-Maidenhead Chalk above referred to was not published in the Proceedings of any Society, we shall take the opportunity of distributing the remaining copies of the paper to the workers to whom this paper will be sent, and shall take pleasure in sending copies of it, so far as possible, to any students of the Foraminifera who may apply for it.

To avoid repetition and economise space in the bibliographical references under each species, we have intimated the occurrence of the species among those recorded in the Prolegomena above referred to by the letters (H-A) after the number. Whenever possible, that is to say in most cases, reference has been made to Egger's excellent monograph on the Foraminifera of the Upper Bavarian Chalk, which is by far the most complete and best illustrated work on Cretaceous Foraminifera.

In order to restrict the present paper to those species of the Cretaceous origin of which there can be no shadow of a doubt, we

* Prolegomena towards the Study of the Chalk Foraminifera: an elementary paper on the collection, preparation, examination, identification, and mounting of Foraminifera from the Chalk, illustrated by a study of the Chalk from the Twyford-Maidenhead Railway cutting. By Edward Heron-Allen, F.L.S., F.R.M.S., London: Nichols, 1894.

† On Microzoa from the Phosphatic Chalk of Taplow. By F. Chapman, F.R.M.S., Quart. Journ. Geol. Soc., 1892, p. 514.

have included nothing which was not obtained from the interior of unbroken flints found on the Selsey foreshore. Apart from these, however, we have recorded the following list of species, found free in the shore-sand, and which, judged by their external appearance or known records, have been derived from Cretaceous sources probably by the breaking up of similar flints, as previously suggested.

7. *Spiroloculina tenuis* Czjzek sp.
 23. *Miliolina linnæana* d'Orbigny sp.
 12. " *seminulum* Linné sp.
 36. *Cornuspira involvens* Reuss sp.
 52. *Ammodiscus incertus* d'Orbigny sp.
 62. *Verneulina spinulosa* Reuss sp.
 * *Spiroplecta biformis* Parker and Jones.
 77. *Bulimina elegans* d'Orbigny.
 75. " *affinis* d'Orbigny.
 * " *elegantissima* d'Orbigny.
 * " *fusiformis* Williamson.
 * " *marginata* d'Orbigny.
 80. " *pupoides* d'Orbigny.
 81. " *squamigera* d'Orbigny.
 83. *Bolivina onariensis* Costa sp.
 84. " *beyrichi* Reuss sp.
 88. " *plicata* d'Orbigny.
 * " *robusta* Brady.
 * *Lagena bicarinata* Terquem.
 102. " *hexagona* Williamson sp.
 103. " *lævigata* Reuss sp.
 95. " *lævis* Montagu sp.
 * " *lineata* Williamson.
 104. " *lucida* Williamson sp.
 106. " *orbignyana* Seguenza sp.
 * " *orbignyana* (var. *Walleriana*) Wright.
 * " *formosa* Schwager.
 99. " *semistriata* Williamson.
 100. " *squamosa* Montagu sp.
 95. " *striata* d'Orbigny sp.
 96. " *sulcata* Walker and Jacob sp.
 108. *Nodosaria* (G) *lævigata* d'Orbigny.
 * *Vaginulina legumen* Linné sp.
 117. *Cristellaria crassa* d'Orbigny.
 130. *Polymorphina communis* d'Orbigny.
 128. " *complanata* d'Orbigny.
 127. " *compressa* d'Orbigny.
 120. " *lactea* Walker and Jacob.
 121. " " (var. *oblonga*) Williamson.
 126. " *lanceolata* Reuss.
 131. " *rotundata* Bornemann sp.
 124. " *sororia* Reuss.
 136. " *spinosa* d'Orbigny sp.
 * *Uvigerina asperula* Brady.
 148. *Spirillina inæqualis* Brady.
 147. " *vivipara* Ehrenberg.

* Species appearing in this place without any number will be found recorded in the Supplement.

167. *Discorbina biconcava* Parker and Jones.
 166. „ *dimidiata* Jones and Parker.
 159. „ *isabelleana* d'Orbigny sp.
 156. „ *obtusa* d'Orbigny sp.
 160. „ *orbicularis* Terquem sp.
 161. „ *parisiensis* d'Orbigny sp.
 * „ *polystomelloides* Parker and Jones.
 153. „ *turbo* d'Orbigny sp.
 * „ *ventricosa* Brady.
 176. *Truncatulina lobatula* Walker and Jacob sp.
 * *Anomalina ariminensis* d'Orbigny.
 195. *Pulvinulina exigua* Brady.
 205. *Rotulia calcar* d'Orbigny.
 204. „ *suessoniensis* d'Orbigny.
 210. *Nonionina pompilioides* Fichtel and Moll sp.
 214. „ *scapha* Fichtel and Moll sp.
 209. „ *umbilicatula* Montagu sp.
 220. *Operculina ammonoides* Gronovius sp.
 219. „ *complanata* Defrance.

In view of the recognised difficulty of determining the geological age of derived fossils, it must be understood that the above list is published with all reservations.

SUB-KINGDOM PROTOZOA.

CLASS RHIZOPODA.

ORDER FORAMINIFERA.

Family II. MILIOLIDÆ.

Sub-family 1. Nubecularinae.

Nubecularia Defrance.

1. (H-A) *Nubecularia lucifuga* Defrance.
 (Plate VI. figs. 1, 2.)

The fragments figured are probably referable to this species. It will be seen that sponge spicules are utilised in the construction of the test, being imbedded in the shell substance. The incorporation of sand grains and shell fragments is a very frequent occurrence in recent *Nubecularia*, but we have never seen another instance of the utilisation of sponge spicules by this genus.

Sub-family 2. Miliolininae.

Spiroloculina d'Orbigny.

5. *Spiroloculina excavata* d'Orbigny.
 (Plate VI. fig. 3.)

This species was described by d'Orbigny from Miocene beds in the Vienna Basin, but it does not appear to have been recorded

* Species appearing in this place without any number will be found recorded in the Supplement.

from the Chalk. *Spiroloculina cretacea** Reuss, however, which is also figured and described in Egger's monograph (Foram. Kreidemergeln der Oberbayerischen Alpen, 1899, p. 21, pl. i. figs. 22-24), is a weakly developed form of the *excavata* type.

Sub-family 4. **Peneroplidinae**,

Cornuspira Schulze.

36. (H-A) *Cornuspira involvens* Reuss.

Family IV. **LITUOLIDAE**.

Sub-family 1. **Lituolinae**.

Reophax Montfort.

226. *Reophax scorpiurus* Montfort.

Reophax scorpiurus Montfort, 1808, Conchyl. Syst. vol. i. p. 330, 85^e genre.

Reophax helvetica Haensler, 1883, Quart. Journ. Geol. Soc., vol. xxxix. p. 27, pl. ii. figs. 8-10.

Reophax scorpiurus (Montfort) Brady, 1884, Foram. 'Challenger,' p. 291, pl. xxx. figs. 12-17.

One fragment doubtfully referred to this species, which does not appear to have been recorded from the Chalk, although Haensler records it from the Jurassic of Switzerland under the synonym *Reophax helvetica*.

Haplophragmium Reuss.

227. *Haplophragmium fontinense* Terquem.

Haplophragmium fontinense Terquem, 1870, Mém. Acad. Imp. Metz., 1869-70, p. 235, pl. xxiv. figs. 29, 30.

Ditto. (Terquem) Brady, 1884, Foram. 'Challenger,' p. 305, pl. xxxiv. figs. 1-4.

Ditto. (Terquem) Egger, 1899, Foram. Kreidemergeln der Oberbayerischen Alpen, p. 140, pl. i. figs. 14-16, 19, 20, 25-29; pl. ii. figs. 40-42.

228. (H-A) *Haplophragmium inflatum* Reuss sp.

(Plate VI. figs. 4, 5.)

Spirolina inflata Reuss, 1851, Haidinger's Naturw. Abh. Band iv., Abth. 1, p. 32, pl. ii. figs. 5, 6.

Haplophragmium inflatum (Reuss) Egger, 1899, Foram. Kreidemergeln der Oberbayerischen Alpen, p. 143, pl. iii. figs. 8, 9, 18.

Sub-family 2. **Trochammininae**.

Webbina d'Orbigny.

229. (H-A) *Webbina irregularis* d'Orbigny.

Webbina irregularis d'Orbigny, 1850, Prodrom. Paléont., vol. ii. p. 111, No. 783.

* *Spiroloculina cretacea* Reuss, 1854, Denkschr. K. Akad. Wiss. Wien, vol. vii. pt. i. p. 72, pl. xxvi. fig. 9.

Family V. TEXTULARIDÆ.

Sub-family 1. Textularinae.

Textularia DeFrance.56. *Textularia agglutinans* d'Orbigny.

Recorded by Burrows, Sherborn and Baily, from the Red Chalk (Journ. R. Micr. Soc., 1890).

58. (H-A) *Textularia globulosa* Ehrenberg.

Perhaps the most typical of all Chalk Foraminifera.

230. *Textularia trochus* d'Orbigny.

Textularia trochus d'Orbigny, 1840, Mém. Soc. Géol. France, vol. iv., mém. 1, p. 45, pl. iv. figs. 25, 26.

Ditto. (d'Orbigny) Brady, 1884, Foram. 'Challenger,' p. 366, pl. xliii. figs. 15-19, xliv. figs. 1-3.

Ditto. (d'Orbigny) Egger, 1899, Foram. Kreidemergeln der Oberbayerischen Alpen, p. 28, pl. xiv. figs. 27, 28.

231. (H-A) *Textularia turris* d'Orbigny.

Textularia turris d'Orbigny, 1840, Mém. Soc. Géol. France, vol. iv. p. 46, pl. iv. figs. 27, 28.

Ditto. (d'Orbigny) Brady, 1884, Foram. 'Challenger,' p. 366, pl. xliv. figs. 4, 5.

Ditto. (d'Orbigny) Egger, 1899, Foram. Kreidemergeln der Oberbayerischen Alpen, p. 29, pl. xiv. fig. 29.

This is one of the most typical of Chalk Foraminifera.

Verneuilina d'Orbigny.62 (H-A) *Verneuilina spinulosa* Reuss.63 (H-A) *Verneuilina triquetra* Münster.*Tritaxia* Reuss.232. (HA) *Tritaxia foveolata* Marsson.

Tritaxia foveolata Marsson, 1878, Mitth. Nat. Ver. Neu-Pommern u. Rügen, Jahrg. x. p. 161, pl. iii. fig. 30 a, b, c.

Ditto. (Marsson) Egger, 1899, Foram. Kreidemergeln der Oberbayerischen Alpen, p. 42, pl. iv. figs. 32-34.

65. (H-A) *Tritaxia tricarinata* Reuss.*Spiroplecta* Ehrenberg.233. (H-A) *Spiroplecta praelonga* Reuss sp.

(Plate VI. fig. 6.)

Textularia praelonga Reuss, 1845-1846, Verstein. Böhm. Kreide, vol. i. p. 39, pl. xii. fig. 14.

Spiroplecta praelonga (Reuss) Wright, 1886, Proc. Belfast Nat. Field Club, app. ix. p. 329, pl. xxvii. fig. 3.

This species differs very little from *Spiroplecta annectens* Parker and Jones, except in the smaller size of the early spiral portion and the increasing breadth of the later Textularian portion of the shell. *S. annectens* has been recorded from the Chalk of Taplow by Chapman, and also by Heron-Allen in his "Prolegomena," and by Egger from the Bavarian Chalk, etc. Probably many of the records should refer to the more typical cretaceous species *S. prælonga*.

68. (H-A) *Spiroplecta sagittula* Defrance.*Gaudryina* d'Orbigny.234. (H-A) *Gaudryina pupoides* d'Orbigny.*Gaudryina pupoides* d'Orbigny, 1840, Mém. Soc. Géol. France, vol. iv. mém. 1, p. 44, pl. iv. figs. 22-24.

Ditto. (d'Orbigny) Brady, 1884, Foram. 'Challenger,' p. 378, pl. xlvi. figs. 1-4.

Ditto. (d'Orbigny) Egger, 1899, Foram. Kreidemergeln der Oberbayerischen Alpen, p. 37, pl. iv. figs. 19, 20.

235. *Gaudryina subrotundata* Schwager.*Gaudryina subrotundata* Schwager, 1866, Novara-Exped. Geol. Theil., vol. ii. p. 198, pl. iv. fig. 9, a, b, c.

Ditto. (Schwager) Brady, 1884, Foram. 'Challenger,' p. 380, pl. xlvi. fig. 13, a, b, c.

Not previously recorded from the Chalk.

236. (H-A) *Gaudryina rugosa* d'Orbigny.*Gaudryina rugosa* d'Orbigny, 1840, Mém. Soc. Géol. France, vol. iv. mém. 1, p. 44, pl. iv. figs. 20, 21.

Ditto. (d'Orbigny) Brady, 1884, Foram. 'Challenger,' p. 381, pl. xlvi. figs. 14-16.

Ditto. (d'Orbigny) Egger, 1899, Foram. Kreidemergeln der Oberbayerischen Alpen, p. 37, pl. iv. figs. 14, 15.

237. (H-A) *Gaudryina Jonesiana* J. Wright.*Gaudryina Jonesiana* J. Wright, 1886, Proc. Belfast Nat. Field Club, 1881-5 app. ix. p. 329, pl. xxvii. figs. 1, 2.*Clavulina* d'Orbigny.238. *Clavulina angularis* d'Orbigny.

(Plate VI. fig. 7.)

Clavulina angularis d'Orbigny, 1826, Ann. Sci. Nat., vol. vii. p. 268, No. 2, pl. xii. fig. 7.

Ditto. (d'Orbigny) Brady, 1884, Foram. 'Challenger,' p. 396, pl. xlvi. figs. 22-24.

This species does not appear to have been recorded from the Chalk, though its ally *C. parisiensis* d'Orb. has been recorded by Egger from the Bavarian Chalk.

Sub-family 2. Bulimininae.

Bulimina d'Orbigny.239. (H-A) *Bulimina variabilis* d'Orbigny.

Bulimina variabilis d'Orbigny, 1840, Mém. Soc. Géol. France, vol. iv. mém. 1, p. 40, pl. iv. figs. 9-12; facsimile in Science Gossip, 1870, p. 156, figs. 145, 146.

Polyphragma variabile (d'Orbigny) Egger, 1899, Foram. Kreidemergeln der Oberbayerischen Alpen, p. 19, pl. xxiii. figs. 1, 2, 3.

75. (H-A) *Bulimina affinis* d'Orbigny.240. *Bulimina ovulum* Reuss.

Bulimina ovulum Reuss, 1845-46, Verstein. Böhm. Kreideformation, vol. 1, p. 37, pl. viii. fig. 57; pl. xiii. fig. 73.

Ditto. (Reuss) Egger, 1899, Foram. Kreidemergeln der Oberbayerischen Alpen, p. 50, pl. xv. fig. 46.

This species is hardly separable from *Bulimina affinis* d'Orbigny.

241 (H-A) *Bulimina Presti* Reuss.

Bulimina Presti Reuss, 1845-46, Verstein. Böhm. Kreideformation, vol. i. p. 38, pl. xiii. fig. 72.

Ditto. (Reuss) Egger, 1899, Foram. Kreidemergeln der Oberbayerischen Alpen, p. 52, pl. xv. fig. 56.

242. (H-A) *Bulimina ovata* d'Orbigny. (Plate VI. fig. 8.)

Bulimina ovata d'Orbigny, 1846, Foram. Foss. Vienne, p. 185, pl. xi. figs. 13, 14.

Ditto. (d'Orbigny) Brady, 1884, Foram. 'Challenger,' p. 400, pl. 1. fig. 13 a, b.

Ditto. (d'Orbigny) Egger, 1899, Foram. Kreidemergeln der Oberbayerischen Alpen, p. 49, pl. xv. p. 45.

243. (H-A) *Bulimina pyrula* d'Orbigny. (Plate VI. figs. 9, 10.)

Bulimina pyrula d'Orbigny, 1846, Foram. Foss. Vienne, p. 184, pl. xi. figs. 9, 10.

Ditto. (d'Orbigny) Brady, 1884, Foram. 'Challenger,' p. 399, pl. 1. figs. 7-10.

EXPLANATION OF PLATE VII.

- Fig. 1.—*Bolivina decorata* Rupert Jones. × 100.
 ,, 2.—Ditto. Ditto.
 ,, 3.—*B. punctata* d'Orbigny. × 50.
 ,, 4.—*Nodosaria hispida* d'Orbigny. × 50.
 ,, 5.—Ditto. Ditto.
 ,, 6.—*N. mucronata* Neugeboren. × 100.
 ,, 7.—*N. obscura* Reuss. × 100.
 ,, 8.—*N. plebeia* Reuss. × 100.
 ,, 9.—*Lingulina carinata* d'Orbigny. × 50.
 ,, 10.—*Fronicularia angulosa* d'Orbigny. × 50.
 ,, 11.—*F. archiaciana* d'Orbigny. × 50.
 ,, 12.—Ditto. Edge view, young specimen. × 50.
 ,, 13.—*F. inæqualis* Costa. × 50.
 ,, 14.—*F. crassa* Reuss. × 50.
 ,, 15.—*F. Verneuiliana* d'Orbigny. × 50.



244. *Bulimina elegantissima* d'Orbigny.

(Plate VI. fig. 12.)

Bulimina elegantissima d'Orbigny, 1839, Foram. Amér. Mérid., p. 51, pl. vii. figs. 13, 14.

Ditto (d'Orbigny) Brady, 1884, Foram. 'Challenger,' p. 402, pl. l. figs. 20-22.

Not previously recorded from the Chalk.

76. (H-A) *Bulimina brevis* d'Orbigny.77. (H-A) *Bulimina elegans* d'Orbigny.

(Plate VI. fig. 11.)

245. (H-A) *Bulimina Murchisoniana* d'Orbigny.*Bulimina Murchisoniana* d'Orbigny, 1840, Mém. Soc. Géol. France, vol. iv. mém. 1, p. 41, pl. iv. figs. 15, 16.

Ditto. (d'Orbigny) Egger, 1899, Foram. Kreidemergeln der Oberbayerischen Alpen, p. 51, pl. xv. figs. 49, 50.

Virgulina d'Orbigny.246. (H-A) *Virgulina schreibersiana* Czjzek.

(Plate VI. fig. 13.)

Virgulina schreibersiana Czjzek, 1847, Haidinger's Naturw. Abhandl., vol. ii. p. 147, pl. xiii. figs. 18-21.

Ditto. (Czjzek) Brady, 1884, Foram. 'Challenger,' p. 414, pl. lii. figs. 1-3.

Bolivina d'Orbigny.247. (H-A) *Bolivina obsoleta* Eley sp.*Textularia obsoleta* Eley, 1859, Geology in the Garden, p. 202, pl. viii. fig. 11c.*Textularia quadrilatera* Schwager, 1866, Novara Exped. Geol. Theil., vol. ii. p. 253, pl. vii. fig. 103.

Ditto. (Schwager) Brady, 1884, Foram. 'Challenger,' p. 358, pl. xlii. figs. 8-12.

Owing to the character of the aperture, this species should be classed with *Bolivina* rather than with *Textularia*.86. *Bolivina lævigata* Williamson sp.Frequently recorded from the Chalk under its synonym *Bolivina textularioides* Reuss.89. *Bolivina punctata* d'Orbigny.

(Plate VII. fig. 3.)

A common, recent and Tertiary fossil. Also recorded by Chapman from the Chalk of Taplow, and, under its synonym *Bolivina elongata* Hantken, by Egger from the Chalk of Bavaria.90. *Bolivina decorata* Jones.

(Plate VII. figs. 1, 2.)

Family VI. CHILOSTOMELLIDÆ.

Ellipsoidella g.n.

Among the specimens obtained from the flint were nine, which were at first attributed to *Pleurostomella subnodosa** Reuss, as they agreed, generally, very well with that author's figures of his species, except in respect of the aperture. This was, in our specimens, a crescentic slit situated at the terminal end of the final chamber, the shell on the convex edge of the crescent rising in a slight projection and curving somewhat over the slit.

The shape of the aperture bore such a striking resemblance to that which is characteristic of *Ellipsoidina* that it was decided to open some of the specimens, and, on effecting this operation, we found our expectations confirmed by the presence of a central tube exactly similar in structure and position to the axial tube of *Ellipsoidina*. (Pl. XI. figs. 1, 2.)

It thus became evident that our specimens occupied a position intermediate between *Pleurostomella* and *Ellipsoidina*, resembling the former genus in the irregular Textularian arrangement of the early chambers, and the latter in the crescentiform aperture, and in the possession of a central column. As *Pleurostomella* is classed with the Textularidæ and *Ellipsoidina* with the Chilostomellidæ, our specimens form a link connecting two families which hitherto have presented hardly any feature in common.

The genus *Pleurostomella* was founded by Reuss for the reception of some fossils from the Westphalian Chalk, and was placed by the author in d'Orbigny's family Stichostegia, which corresponds to some extent with Brady's sub-family Nodosarinæ, including those genera in which the chambers are arranged in a straight or slightly curved line. It was, however, removed by Brady, and is now by general consent retained in Brady's family Textularidæ, to which its affinities certainly belong. It may not be amiss to give a translation of Reuss' description of his genus from the work already referred to. Recognising their abnormal character, he created a new sub-family for the reception of the new genus, and proceeds as follows:—

Pleurostomellidæ.

“An altogether peculiar group, as yet represented only by the single genus *Pleurostomella*. It is therefore sufficient to introduce the characteristic features of the genus which so far have sufficed for the whole family.

Pleurostomella g.n.

“The first species of this genus, *Pleurostomella subnodosa*, I had formerly (regarding the irregularity of the chambers as something casual and unimportant) classified with similar varieties of *Den-*

* *Pleurostomella subnodosa* Reuss. Die Foraminiferen der westphälischen Kreideformation, 1860. Sitz. K. Akad. Wiss. Wien. vol. xl. p. 204, pl. viii. fig. 2, a, b.

talina, and figured and described incorrectly as *Dentalina nodosa** d'Orbigny and *Dentalina subnodosa*† Reuss. When I found more numerous examples of this species in the Westphalian Chalk formation, and still later a second type, *Pleurostomella fusiformis*, and convinced myself of the constant irregularity of the chambers, I was led to the closer inspection of the same, whereby I then at once perceived the great variation in the form and position of the opening, from which naturally and necessarily proceeds the above-mentioned arrangement of the chambers. It was now impossible to include these forms any longer with *Dentalina*.

“Apart from the great similarity to *Dentalina* in the external form, the chief difference lies in the aperture. Instead of the same being round as in *Dentalina* and situated on the end of the last chamber, it represents a half-moon or even semi-elliptic fissure, situated below the top of the chamber, on one side of the same, and on the upper end of a larger or smaller depression which has a raised edge. In consequence of this removal of the position of the aperture from the highest point of the chamber, the chambers no longer stand straight on one another, but each is more or less inclined towards the side aperture of the preceding chamber, so that the sutures take a slanting direction and the shell a slightly undulating curve.

“Moreover, the axis of the *Pleurostomellæ* is either nearly straight as in *Nodosaria* or slightly curved as in *Dentalina*. The shell substance is compact, shining like glass.

“The two species of the genus at present known belong to the Cretaceous formation, one to the white Chalk—the zones of *Belemnitella mucronata* and *B. quadrata*—and the other to the Gault.

“*Pleurostomella subnodosa*.—Length 0·892 mm. Breadth 0·219 mm. Shell straight, rather thick, tapering only a little from below to the blunt point, somewhat irregular (lit. knotted) owing to the alternate slant of all the chambers. All sutures somewhat oblique, especially those of the oldest chambers, and somewhat deep. The chambers arched, especially on the side opposite to the bend. The aperture lies on the upper end of a small, broad, oval, plate-shaped depression, which only takes up a third part of the side surface of the last chamber. It is crescent-shaped, and bounded above and sideways by a sharp rim. Scarce.”

We here reproduce Reuss' figures of *Pleurostomella subnodosa*. (Pl. XI. fig. 3.)

The genus *Ellipsoidina* was founded by Seguenza,‡ in 1859,

* Reuss, 1845-46, Verstein. Böhm. Kreide, vol. i. p. 28, pl. xiii. fig. 22. (The figure is very small and quite unrecognisable.)

† Reuss, 1851, Foram. des Kreidemergels von Lemberg in Haidinger's Naturw. Abhandl., vol. iv. p. 24, pl. i. fig. 9. (The small figure represents a straight right-chambered tapering *Nodosaria*.)

‡ Seguenza, 1859. Eco Peloritano, Giornale di Scienze, Lettere ed Arti, Anno V. serie 2, fasc. 9. Translated and edited by Brady in Ann. Mag. Nat. Hist. 1868, ser. 4, vol. i.

for the reception of some abnormal specimens from the Miocene of Messina. He classed them with d'Orbigny's family Stichostegia, regarding them as allied to *Glundulina*; but Brady subsequently transferred them to his sixth family Chilostomellidæ. At the time of the publication of his Report on the Foraminifera of the 'Challenger' Expedition, the genus was known only from the single species *Ellipsoidina ellipsoides* Seguenza, and Brady's description of the genus was accordingly based on this. He states,* "The chambers are elliptical, and each larger than its predecessor as in *Chilostomella*; but their point of attachment instead of being at one side is at the base, and they are all projected symmetrically in one direction, instead of being directed alternately towards the two ends. The aperture is always at the distal extremity, and takes the form of an arcuate or nearly circular slit, either entire or more commonly divided by shelly bridges. From the centre of the superior end of each segment, that is to say, either from the space enclosed by the curved aperture or its immediate neighbourhood, rises a shelly column of sufficient length to reach to the top of the succeeding chamber. This column is an anomalous feature, to which there is nothing precisely analogous amongst other Foraminifera. It was originally supposed to be a tubular neck serving for the aperture, and the genus was on that account classed with the *Nodosarinæ*, but, as I have elsewhere † shown, this has not proved to be the fact, for the orifice occupies an independent position at its base, and the column itself is not hollow, but it is often deeply grooved longitudinally, or even split into two or three parts near the upper extremity."

In 1894 Mr. R. J. Lechmere Guppy published a paper "On some Foraminifera from the Microzoic Deposits of Trinidad, West Indies," ‡ in which he figured and described two further species of *Ellipsoidina*, viz. *E. subnodosa* Guppy, and *E. exponens* Brady, M.S.

* Brady, 1884. Report on the Foraminifera of the Challenger Expedition, vol. i. p. 435.

† Ann. and Mag. Nat. Hist., ser. 4, vol. i. pp. 333 *et seq.* pl. xiii.

‡ Proc. Zool. Soc. London, Nov. 1894.

EXPLANATION OF PLATE VIII.

- Fig. 1.—*Marginulina glabra* d'Orb. var. *elongata* d'Orb. × 25.
 ,, 2.—*Cristellaria convergens* Bornemann. × 30.
 ,, 3.—*C. vortex*, Fichtel and Moll sp. × 100.
 ,, 4.—*Flabellina Baudouiniana* d'Orbigny. × 50.
 ,, 5.—*F. interpunctata* Von der Marck. × 50.
 ,, 6.—*F. pulchra* d'Orbigny. × 50.
 ,, 7.—*F. rugosa* d'Orbigny. × 50.
 ,, 8.—*Sagrina cretacea* sp. n. × 150.
 ,, 9.—Ditto. Ditto.
 ,, 10.—Ditto. Ditto.
 ,, 11.—*Globigerina æquilateralis* Brady. × 100.
 ,, 12.—Ditto. Ditto.



1



2



3



4



5



6



7



9



8



11

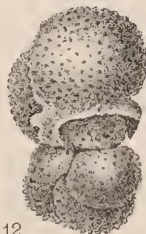

12



10

Both of these depart from the original definition of the genus in the fact that the early chambers are visible instead of being entirely enclosed by the final chamber as in the type. *Ellipsoidina subnodosa*, in fact, to all external appearance is a moniliform Nodosaria, while *Ellipsoidina exponens* resembles a Glanduline Nodosaria.

Mr. Guppy in his description of *E. subnodosa* recognises the close relationship of his species to *Pleurostomella*, and he again draws attention to this in a later paper,* in which he attempts to trace the phylogeny of the Foraminifera, and places the genus *Ellipsoidina* next to *Pleurostomella* in order of divergence from a central stem. In his original description of *E. subnodosa* he remarks, "Notwithstanding the resemblance in shape to a Nodosaria, this may generally be distinguished by its more regularly cylindrical shape, the separation between the chambers being less strongly marked than in most Nodosariæ. The aperture and interior structure are more distinct marks of difference. The species represents a close approach to *Pleurostomella*; but the aperture is not situated in a depression as it is in that genus, it is terminal or nearly so. Further in our new species the segments rarely show a tendency to alternate as they do in *Pleurostomella*, though it is to be observed that in one or two specimens there is an indication of such a tendency near the apex.† The aperture resembles that of *Ellipsoidina ellipsoides* as represented by Brady's figure (Quart. Journ. Geol. Soc. 1888, vol. xlv. pl. i. fig. 1). Some specimens of *Pleurostomella subnodosa* come very close; see for instance the figures given by Burrows, Sherborn and Bailey (Journ. R. Micr. Soc. 1890, pl. viii. figs. 27-30)."

This reference to the figures in Messrs. Burrows, Sherborn and Bailey's paper, on "The Foraminifera of the Red Chalk of Yorkshire, Norfolk and Lincolnshire," is of great interest, as we had already noted the resemblance of their figures to our specimens before reading Mr. Guppy's paper. We think there can be no doubt that the specimens from the Red Chalk should be referred to our type, and not to *Pleurostomella nodosa* Reuss; and it is not unlikely that an examination of the specimens of *P. subnodosa* in collections would lead to the discovery of other instances in which our type has been incorrectly identified as *Pleurostomella subnodosa*.

This has in effect occurred in one instance at least in which sufficient details have been recorded to identify the specimens beyond doubt with our type. Boissel and Holzapfel, in their

* "Observations on some of the Foraminifera of the Oceanic Rocks of Trinidad," Proc. Victoria Institute of Trinidad, 1903, vol. ii. pt. i. p. 15.

† By the courtesy of Mr. Guppy, we have received a good many specimens of *E. subnodosa*, but none of them show any sign of a departure from the moniliform plan of growth either externally or when cut in section.

paper,* describe under the name *P. subnodosa* (Reuss) some specimens which are unquestionably similar to ours, for in the figures they give sections of the shell in which the central column is most distinctly shown. Their description is as follows: "The small initial chamber is oval, and the succeeding chambers are not compressed, but have a depression immediately beneath the apex in which is situated the crescentiform aperture. From this aperture a two-layered column reaches to the base of the shell, by which the aperture itself is contracted into a sickle-shaped slit. The two layers of the column unite in the adult shell, forming a hollow rope (*hohlen Strang*), which traverses the entire length of the shell. The succeeding chambers embrace their predecessors, being stouter on the side which bears the aperture, and developing an aperture on the side opposite to the last. The arrangement of the chambers becomes in this way irregularly biserial. On the surface of the shell the chambers are divided by deep sutures. The whole appearance of the shell is not unlike that of many of the Polymorphinæ, whose finely porous shell-structure is similar to that of the *Pleurostomella*. The most important difference lies in the aperture and in the presence of the vertical column (*Langsröhre*).

"The chambers number 8 to 11. The length of the shell, 2·8 to 4·0 mm. The diameter at the small end is 0·36 to 0·45 mm., and at the oral end 0·90 to 1·0 mm. The diameter of the inner tube (*Röhre*) is 0·036 to 0·091 mm. The specimens figured by Reuss are identical with those from Aix, even to the swollen edges of the aperture, but they are hardly more than one-third of the size of the latter, whilst they agree with them in the number of the chambers."

We propose for our specimens a new genus under the name *Ellipsoidella*, and to place it in Brady's sixth Family Chilostomellidæ. In spite of the difference in size in our specimens we do not think that they represent more than a single species, though they may possibly represent this species in a dimorphous form. Nothing can, however, be decided on this point until the discovery of further specimens permits of a more detailed examination than has at present been practicable.

Family CHILOSTOMELLIDÆ.

Genus *Ellipsoidella* g.n.

Test free, cylindrical, the earlier chambers somewhat compressed and arranged in an irregularly triserial or biserial manner, the later chambers nodosarian; aperture a terminal crescentic slit,

* Die Foram. der Aachener Kreide. Abhandl. der König. Preuss. Geolog. Landesanstalt, n.s. pt. 3, p. 64, pl. xii. figs. 30-38, 1891.

surmounted by a slightly raised and overhanging process. The interior of each chamber traversed from base to apex by a column similar in appearance, position and structure to the internal column of *Ellipsoidina*.

248. *Ellipsoidella pleurostomelloides* sp. n.

(Plate X. figs. 1-11.)

Pleurostomella submodosa Burrows, Sherborn and Bailey, 1890, Journ. R. Micr. Soc., p. 549, pl. viii. figs. 27-30.

Ditto. Boissel, 1891, Abhandl. der Königl. preuss. geolog. Landesanstalt, N.S. pt. iii.

We have at present nothing to add to our definition of the species.

Length	0·5-0 to 0·6 mm.	} large specimens.
Greatest breadth	0·2 mm.	
Length	0·3-0 to 0·4 mm.	} small specimens.
Greatest breadth	0·125 mm.	

Besides the nine specimens found in the interior of the flints, we have two small specimens found free in the shore-sand at the House-pond Bed, which have no doubt been derived from shattered flints.

Family VII. LAGENIDÆ.

Sub-family 1. *Lageninae*.*Lagena* Walker and Boys.92. *Lagena globosa* Montagu.249. (H-A) *Lagena aspera* Reuss.

Lagena aspera Reuss, 1861, Sitzungsab. d. k. Akad. Wiss. Wien, vol. xlv. p. 305, pl. i. fig. 5.

Ditto. (Reuss) Brady, 1884, Foram. 'Challenger,' p. 457, pl. lvii. figs. 7-10, var. figs. 6, 11, 12.

Ditto. (Reuss) Egger, 1899, Foram. Kreidemergeln der Oberbayerischen Alpen, p. 106, pl. v. fig. 10.

250. (H-A) *Lagena gracilis* Williamson.

Lagena gracilis Williamson, 1848, Ann. Mag. Nat. Hist., sér. 2, vol. i p. 13, pl. i. figs. 3, 4.

Ditto. (Williamson) Brady, 1884, Foram. 'Challenger,' p. 464, pl. lviii figs. 2, 3, 7-10, 19, 22-24.

Ditto. (Williamson) Egger, 1899, Foram. Kreidemergeln der Oberbayerischen Alpen, p. 105, pl. v. fig. 14.

96. (H-A) *Lagena sulcata* Walker and Jacob.97. (H-A) *Lagena acuticosta* Reuss.

Sub-family II. Nodosarinae.

Nodosaria Lamarek.251. (H-A) *Nodosaria radricula* Linné sp.

Nautilus radricula Linné, 1767, Syst. Nat. 12th ed. p. 1164, 285; 1788, Ibid. 13th (Gmelin's) ed. vol. i. pt. 6, p. 3373, No. 18.

Nodosaria radricula (Linné) Brady, 1884, Foram. 'Challenger,' p. 495, pl. lxi. figs. 28-31.

Ditto. (Linné) Egger, 1899, Foram. Kreidemergeln der Oberbayerischen Alpen, p. 67, pl. v. fig. 40.

252. (H-A) *Nodosaria farcimen* Soldani sp.

Orthoceras farcimen Soldani, 1791, Testaceographia, vol. i. pt. 2, p. 98, pl. cv. fig. O.

Nodosaria farcimen (Soldani) Brady, 1884, Foram. 'Challenger,' p. 498, pl. lxii. figs. 17, 18.

Ditto. (Soldani) Egger, 1899, Foram. Kreidemergeln der Oberbayerischen Alpen, p. 55, pl. vi. fig. 12.

109. (H-A) *Nodosaria filiformis* d'Orbigny.

Recorded as *Nodosaria gracilis* d'Orbigny.

253. (H-A) *Nodosaria pauperata* d'Orbigny.

Dentalina pauperata d'Orbigny, 1846, Foram. Foss. Vienne, p. 46, pl. i. figs. 57, 58.

Nodosaria pauperata (d'Orbigny) Brady, 1884, Foram. 'Challenger,' p. 500, woodcuts 14a, b, c.

Ditto. (d'Orbigny) Egger, 1899, Foram. Kreidemergeln der Oberbayerischen Alpen, p. 60, pl. vi. fig. 20.

254. (H-A) *Nodosaria Lorneiana* d'Orbigny.

Dentalina Lorneiana d'Orbigny, 1840, Mém. Soc. Géol. France, vol. iv. mém. 1, p. 14, pl. i. figs. 8, 9. Facsimile in Science Gossip, 1870 p. 81, fig. 80.

Nodosaria Lorneiana (d'Orbigny) Egger, 1899, Foram. Kreidemergeln der Oberbayerischen Alpen, p. 56, pl. vi. figs. 21, 22.

EXPLANATION OF PLATE IX.

- Fig. 1.—*Globigerina marginata* d'Orbigny. × 100.
 „ 2.—Ditto. Ditto.
 „ 3.—Ditto. Ditto.
 „ 4.—*Spirillina limbata* Brady. × 100.
 „ 5.—Ditto. Ditto.
 „ 6.—*Truncatulina haidingeri* d'Orbigny. × 100.
 „ 7.—Ditto. Ditto.
 „ 8.—*T. ungeriana* d'Orbigny. × 150.
 „ 9.—Ditto. Ditto.
 „ 10.—*Rotalia exsculpta* Reuss. × 100.
 „ 11.—Ditto. Ditto.
 „ 12.—Ditto. Ditto.



1



2



3

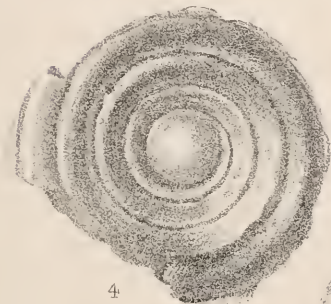

4

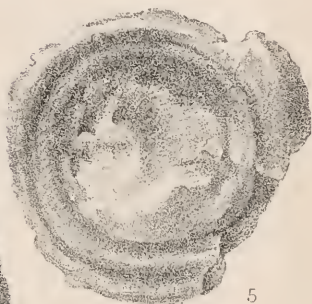

5



7



6

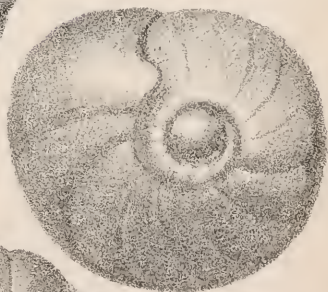

8



9



10

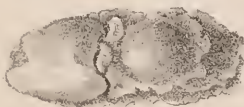

12



11

255. (H-A) *Nodosaria consobrina* d'Orbigny.

Dentalina consobrina d'Orbigny, 1846, Foram. Foss. Vienne, p. 46, pl. ii. figs. 1-3.

Nodosaria consobrina (d'Orbigny) Brady, 1884, Foram. 'Challenger,' p. 501, pl. lxii. figs. 23, 24.

Ditto. (d'Orbigny) Egger, 1899, Foram. Kreidemergeln der Oberbayerischen Alpen, p. 61, pl. v. fig. 44; pl. vi. figs. 31, 32, 33, 36.

256. *Nodosaria plebeia* Reuss.

(Plate VII. fig. 8.)

Dentalina plebeia Reuss, 1855, Zeitschr. d. deutsch. geol. Gesell., vol. vii. pl. 267, pl. viii. fig. 9.

Nodosaria plebeia (Reuss) Brady, 1884, Foram. 'Challenger,' p. 502, pl. lxiii. fig. 2.

Ditto. (Reuss) Egger, 1899, Foram. Kreidemergeln der Oberbayerischen Alpen, p. 65, pl. vi. fig. 25.

257. (H-A) *Nodosaria communis* d'Orbigny.

Nodosaria (*Dentalina*) *communis* d'Orbigny, 1826, Ann. Sci. Nat., vol. vii. p. 254, No. 35.

Nodosaria communis (d'Orbigny) Brady, 1884, Foram. 'Challenger,' p. 504, pl. lxii. figs. 19-22.

Ditto. (d'Orbigny) Egger, 1899, Foram. Kreidemergeln der Oberbayerischen Alpen, p. 65, pl. vi. fig. 4.

258. (H-A) *Nodosaria mucronata* Neugeboren.

(Plate VII. fig. 6.)

Nodosaria (*Dentalina*) *obliqua* d'Orbigny, 1826, Ann. Sci. Nat., vol. vii. p. 254, No. 36: Modèle No. 5.

Dentalina mucronata Neugeboren, 1856, Denkschr. d. k. Akad. Wiss. Wien, vol. xii. p. 83, pl. iii. figs. 8-11.

Nodosaria mucronata (Neugeboren) Brady, 1884, Foram. 'Challenger,' p. 506, pl. lxii. figs. 27-29, 30, 31.

Ditto. (Neugeboren) Egger, 1899, Foram. Kreidemergeln der Oberbayerischen Alpen, p. 66, pl. vi. figs. 6, 7, 8.

259. (H-A) *Nodosaria hispida* d'Orbigny.

(Plate VII. figs. 4, 5.)

Nodosaria hispida d'Orbigny, 1846, Foram. Foss. Vienne, p. 35, pl. i. figs. 24, 25.

Ditto. (d'Orbigny) Brady, 1884, Foram. 'Challenger,' p. 507, pl. lxiii. figs. 12-16.

Ditto. (d'Orbigny) Egger, 1899, Foram. Kreidemergeln der Oberbayerischen Alpen, p. 79, pl. viii. figs. 11-14; pl. ix. figs. 23, 24.

260. (H-A) *Nodosaria raphanus* Linné sp.

Nautilus raphanus Linné, 1767, Syst. Nat. 12th ed., p. 1164, 283; 1788, Ibid. 13th (Gmelin's) ed., p. 3372, No. 16

Nodosaria raphanus (Linné) Brady, 1884, Foram. 'Challenger,' p. 512, pl. lxiv. figs. 6-10.

261. (H-A) *Nodosaria obscura* Reuss.

(Plate VII. fig. 7.)

Nodosaria obscura Reuss, 1845-1846, Verstein. Böhm. Kreideformation, vol. i. p. 26, pl. xiii. figs. 7-9.

Ditto. (Reuss) Egger, 1899, Foram. Kreidemergeln der Oberbayerischen Alpen, p. 75, pl. xxiv. fig. 23.

This species is synonymous with *N. raphanus* Linné, being distinguishable only by its minute size and the delicate costæ.

262. (H-A) *Nodosaria conferta* Reuss.*Nodosaria conferta* Reuss, 1845-1846, Verstein. Böhm. Kreideformation, vol. i. p. 26, pl. xiii. fig. 10.263. (H-A) *Nodosaria Zappei* Reuss.*Nodosaria Zappei* Reuss, 1845-1846, Verstein. Böhm. Kreideformation, vol. i. p. 25, pl. viii. figs. 1-3.

Ditto. (Reuss) Egger, 1899, Foram. Kreidemergeln der Oberbayerischen Alpen, p. 78, pl. viii. figs. 1-3.

264. *Nodosaria Steenstrupi* Reuss.*Dentalina Steenstrupi* Reuss, 1855, Zeitschr. deutsch. geol. Gesellsch., vol. vii. p. 268, pl. viii. fig. 14a.*Nodosaria Steenstrupi* (Reuss) Egger, 1899, Foram. Kreidemergeln der Oberbayerischen Alpen, p. 70, pl. vii. fig. 27.*Lingulina* d'Orbigny.265. *Lingulina carinata* d'Orbigny.

(Plate VII. fig. 9.)

Lingulina carinata d'Orbigny, 1826, Ann. Sci. Nat., vol. vii. p. 257, No. 1 Modèle, No. 26.

Ditto. (d'Orbigny) Brady, 1884, Foram. 'Challenger,' p. 517, pl. lxxv. figs 16, 17.

Only the characteristic fissure-like aperture serves to identify the specimen which we have figured as belonging to this species. In all other respects it would pass for a Glanduline *Nodosaria* (*N. laevigata* d'Orb), there being no noticeable compression of the test. There can be no doubt as to the close relationship of the two forms.

Frondicularia Defrance.266. (H-A) *Frondicularia angulosa* d'Orbigny.

(Plate VII. fig. 10.)

Frondicularia angulosa d'Orbigny, 1840, Mém. Soc. Géol. France, vol. iv. mém. 1, p. 22, pl. i. fig. 39. Facsimile in Science Gossip, 1870 p. 83, fig. 94.

267. (H-A) *Frondicularia Archiaciana* d'Orbigny.

(Plate VII. figs. 11, 12.)

Frondicularia Archiaciana d'Orbigny, 1840, Mém. Soc. Géol. France, vol. iv. mém. 1, p. 20, pl. i. figs. 34, 36. Facsimile in Science Gossip, 1870, p. 82, fig. 91.

Frondicularia Archiaciana (d'Orbigny) Egger, 1899, Foram. Kreidemergeln der Oberbayerischen Alpen, p. 87, pl. x. fig. 19, 20.

268. (H-A) *Frondicularia Verneuiliana* d'Orbigny.

(Plate VII. fig. 15.)

Frondicularia Verneuiliana d'Orbigny, 1840, Mém. Soc. Géol. France, vol. iv. mém. 1, p. 20, pl. i. figs. 32, 33. Facsimile in Science Gossip, 1870, p. 82, fig. 90.

269. (H-A) *Frondicularia gaultina* Reuss.

Frondicularia gaultina Reuss, 1860, Sitz. k. Akad. Wiss. Wien, vol. xl. p. 194, pl. v. fig. 5.

270. (H-A) *Frondicularia inversa* Reuss.

Frondicularia inversa Reuss, 1845-46, Verstein. Böhm. Kreideformation, vol. i. p. 31, pl. viii. figs. 15-19; pl. xiii. fig. 42.

Ditto. (Reuss) Egger, 1899, Foram. Kreidemergeln der Oberbayerischen Alpen, p. 90, pl. x., figs. 3, 4.

The specimen is not typical.

271. (H-A) *Frondicularia marginata* Reuss.

Frondicularia marginata Reuss, 1845-46, Verstein. Böhm. Kreideformation, vol. i. p. 30, pl. xii. fig. 9; and vol. ii. p. 107, pl. xxiv. figs. 39, 40.

111. *Frondicularia inaequalis* Costa.

(Plate VII. fig. 13.)

272. (H-A) *Frondicularia crassa* Reuss.

(Plate VII. fig. 14.)

Frondicularia crassa Reuss, 1841, Geogr. Skizze Böhmen II. (I.), 212.

Marginulina d'Orbigny.273. *Marginulina glabra* d'Orbigny, var. *elongata* d'Orbigny.

(Plate VIII. fig. 1.)

Marginulina elongata d'Orbigny 1840, Mém. Soc. Géol. France, vol. iv. mém. 1, p. 17, pl. i. figs. 20-22. Facsimile in Science Gossip, 1870, p. 82, fig. 85.

Ditto. (d'Orbigny) Egger, 1899, Foram. Kreidemergeln der Oberbayerischen Alpen, p. 95, pl. ix. fig. 22; pl. xii. figs. 14, 15.

274. *Marginulina hispida* Neugeboren.

Marginulina hispida Neugeboren, 1851, Verh. Mitth. Siebenburg. Ver. Nat., vol. ii. p. 142, pl. iv. fig. 22.

275. (H-A) *Marginulina trilobata* d'Orbigny.

Marginulina trilobata d'Orbigny, 1840, Mém. Soc. Géol. France, vol. iv. mém. I, p. 16, pl. i. figs. 16, 17. Facsimile in Science Gossip, 1870, p. 82, fig. 83.

Vaginulina d'Orbigny.276. *Vaginulina legumen* Linné sp.

Nautilus legumen Linné, 1758, Syst. Nat. 10th ed. p. 711, No. 248; 1767 Ibid., 12th ed. p. 1164, No. 288.

Vaginulina legumen (Linné) Brady, 1884, Foram. 'Challenger,' p. 530, pl. lxi. figs. 13-15.

Ditto. (Linné) Egger, 1899, Foram. Kreidemergeln der Oberbayerischen Alpen, p. 98, pl. ix. figs. 29, 30.

Cristellaria Lamarek.114. (H-A) *Cristellaria crepidula* Fichtel and Moll.113. *Cristellaria lata* Cornuel sp.277. *Cristellaria Marcki* Reuss.

Cristellaria Marcki Reuss, 1860, Sitz. k. Akad. Wiss. Wien., vol. xl. p. 212, pl. ix. fig. 4 *a, b*.

Cristellaria Marckii (Reuss) Burrows, Sherborn and Bailey, 1890, Journ. R. Micr. Soc., p. 12, pl. xi. fig. 5 *a, b*.

278. *Cristellaria scitula* Berthelin.

Cristellaria scitula Berthelin, 1880, Mém. Soc. Géol. France, vol. i. mém. 3, p. 54, pl. iii. fig. 3, *a-c*.

Ditto. (Berthelin) Egger, 1899, Foram. Kreidemergeln der Oberbayerischen Alpen, p. 114, pl. xii. figs. 35, 36, 37.

This pretty little form belongs to the *crepidula* group, but the early spiral portion is very slightly developed; the later chambers are produced in a straight Marginuline series.

EXPLANATION OF PLATE X.

Fig. 1.—*Ellipsoidella pleurostomelloides* sp.n. Large type of shell. × 100.

„ 2.—Ditto. Ditto. × 100.

„ 3.—Ditto. Ditto. × 100. The last chamber broken.

„ 4.—Ditto. Small type of shell. × 100.

„ 5.—Ditto. Ditto. × 100.

„ 8.—Ditto. Ditto. × 100.

„ 9.—Ditto. Ditto. × 100.

„ 6.—Ditto. Large type of shell. The last three chambers laid open to show central column and the aperture, which is alternately on either side of the column in successive chambers. × 100.

„ 7.—Ditto. View of aperture when shell is viewed from the top.

„ 10.—Ditto. A small and imperfect specimen, viewed in balsam, as a transparent object. × 100.

„ 11.—Ditto. A fragment, in balsam, viewed as a transparent object. × 100. This differs from the other specimens in the fact that the column is curved in opposite directions in successive chambers, and is apparently not continued to the top of the chamber.

Note.—Owing to the infiltration of calcareous matter, and possibly subsequent chemical changes in fossilization, it was very difficult to distinguish the internal structure of the balsam specimens, owing to their opacity.



1



2



3



4



6



5



8



9



10



7



11

279. (H-A) *Cristellaria recta* d'Orbigny.

Cristellaria recta d'Orbigny, 1840, Mém. Soc. Géol. France, vol. iv. mém. 1, p. 28, pl. ii. figs. 23-25. Facsimile in Science Gossip, 1870, p. 107, fig. 110.

280. *Cristellaria acutaureicularis* Fichtel and Moll sp.

Nautilus acutaureicularis Fichtel and Moll, 1803, Test. Micr., p. 102, pl. xviii. figs. *g-i*.

Cristellaria acutaureicularis (Fichtel and Moll) Brady, 1884, Foram. 'Challenger,' p. 543, pl. cxiv. fig. 17.

281. (H-A) *Cristellaria navicula* d'Orbigny.

Cristellaria navicula d'Orbigny, 1840, Mém. Soc. Géol. France, vol. iv. mém. 1, p. 27, pl. ii. figs. 19, 20. Facsimile in Science Gossip, 1870, p. 107, fig. 108.

Ditto. (d'Orbigny) Egger, 1899, Foram. Kreidemergeln der Oberbayerischen Alpen, p. 116, pl. xii. figs. 3, 4.

This species is but one of the innumerable forms of *C. acutaureicularis* Fichtel and Moll.

282. (H-A) *Cristellaria triangularis* d'Orbigny.

Cristellaria triangularis d'Orbigny, 1840, Mém. Soc. Géol. France, vol. iv. mém. 1, p. 27, pl. ii. figs. 21, 22. Facsimile in Science Gossip, 1870, p. 107, fig. 109.

Ditto. (d'Orbigny) Egger, 1899, Foram. Kreidemergeln der Oberbayerischen Alpen, p. 117, pl. xii. figs. 5, 6.

283. (H-A) *Cristellaria convergens* Bornemann.

(Plate VIII. fig. 2.)

Cristellaria convergens Bornemann, 1855, Zeitschr. d. deutsch. geol. Gesellsch. vol. vii. p. 327, pl. xiii. figs. 16, 17.

Ditto. (Bornemann) Brady, 1884, Foram. 'Challenger,' p. 546, pl. lxxix. figs. 6, 7.

116. (H-A) *Cristellaria rotulata* Lamarck.284. (H-A) *Cristellaria vortex* Fichtel and Moll sp.

(Plate VIII. fig. 3.)

Nautilus vortex Fichtel and Moll, 1803, Test. Micr., p. 33, pl. ii. figs. *d-i*.

Cristellaria vortex (Fichtel and Moll) Brady, 1884, Foram. 'Challenger,' p. 548, pl. lxxix. figs. 14-16.

The single specimen found is intermediate between this species and its close ally *C. orbicularis* d'Orbigny, which is furnished with a prominent keel.

119. (H-A) *Cristellaria cultrata* Montfort.

Flabellina d'Orbigny.

285. *Flabellina pulchra* d'Orbigny.

(Plate VIII. fig. 6.)

Flabellina pulchra d'Orbigny, 1840, Mém. Soc. Géol. France, vol. iv. mém. 1, p. 25, pl. ii. figs. 12-14. Facsimile in Science Gossip, 1870, p. 106, fig. 105.

286. (H-A) *Flabellina Baudouiniana* d'Orbigny.

(Plate VIII. fig. 4.)

Flabellina Baudouiniana d'Orbigny, 1840, Mém. Soc. Géol. France, vol. iv. mém. 1, p. 24, pl. ii. figs. 8-11. Facsimile in Science Gossip, 1870, p. 106, fig. 104.

287. (H-A) *Flabellina rugosa* d'Orbigny.

(Plate VIII. fig. 7.)

Flabellina rugosa d'Orbigny, 1840, Mém. Soc. Géol. France, vol. iv. mém. 1, p. 23, pl. ii. figs. 4, 5, 7. Facsimile in Science Gossip, 1870, p. 106, fig. 106.

Ditto. (d'Orbigny) Egger, 1899, Foram. Kreidemergeln der Oberbayerischen Alpen, p. 108, pl. x. figs. 5, 6, pl. xiii. figs. 1, 2.

288. (H-A) *Flabellina interpunctata* von der Marck.

(Plate VIII. fig. 5.)

Flabellina interpunctata von der Marck, 1858, Verh. Nat. Ver. preuss. Rheinb., vol. xv. p. 53, pl. i. fig. 5.

The characteristic surface markings are poorly represented in our specimen.

Sub-family 3. Polymorphininae.

Polymorphina d'Orbigny.120. *Polymorphina lactea* Walker and Jacob.124. *Polymorphina sororia* Reuss.*Uvigerina* d'Orbigny.289. *Uvigerina canariensis* d'Orbigny.

Uvigerina canariensis d'Orbigny, 1839, Foram. Canaries, p. 138, pl. i. figs. 25-27. Ditto. (d'Orbigny) Brady, 1884, Foram. 'Challenger,' p. 573, pl. lxxiv. figs. 1-3.

Recorded by Chapman from the Chalk of Taplow.

290. *Uvigerina pygmaea* d'Orbigny.

Uvigerina pygmaea d'Orbigny, 1826, Ann. Sci. Nat., vol. vii. p. 269, pl. xii. figs. 8, 9: Modèle No. 67.

Ditto. (d'Orbigny) Brady, 1884, Foram. 'Challenger,' p. 575, pl. lxxiv. figs. 11-14.

One specimen (in which the phialine aperture is wanting) is somewhat doubtfully referred to this species, which has not previously been recorded from the Chalk.

Sagrina Parker and Jones.

291. *Sagrina cretacea* sp. n.

(Plate VIII. figs. 8-10.)

Test minute, smooth, wedge-shaped, compressed and excavated laterally, the edges of the chambers rounded, regularly scalloped, and undercut. The shell commences with a few Uvigerine chambers, followed by 3 to 5 pairs of chambers arranged in a regular biserial manner, the last chamber terminating in a produced phialine neck. The outer edge of each chamber is raised into a slight keel from which the surface of the chambers sinks away towards the sutures and median line of the shell, which is consequently the thinnest part of the test. Length 0·2 to 0·3 mm. Breadth 0·15 mm.

This pretty little species may be regarded as an isomorph of *Bolivina obsoleta* (Eley sp.) to which it bears a superficial resemblance in contour and markings. Its nearest ally is apparently *Sagrina aspera** (Marsson), with which it agrees in size and to some extent in the arrangement of chambers, differing, however, in texture of the shell, which in Marsson's species is rough or prickly. The undercutting of the chambers, which is so marked in the British specimens, is also absent in Marsson's species. Marsson's figure shows only seven chambers in a section of the test, which is megalospheric. Our species may possibly be the microspheric form.

Sagrina cretacea is probably a widely distributed and typical Chalk fossil. It certainly occurs in the Chalk of Kent (Keston) and Herts (Watford) and Rottingdean (Sussex), and will probably be found wherever closely searched for in the Middle and Upper Chalk. Its small size and resemblance to other species are no doubt the reasons for its having so long evaded observation.

Sub-family 4. Ramulininæ.

Ramulina Rupert Jones.

292. (H-A) *Ramulina aculeata* Wright.

Dentalina aculeata d'Orbigny 1840, Mém. Soc. Géol. France, vol. iv., mém. 1, p. 13, pl. i. figs. 2, 3. Facsimile in Science Gossip, 1870, p. 81, fig. 76.]

Ramulina aculeata (d'Orbigny) Wright, 1886, Proc. Belfast Nat. Field Club (1884-85), App. ix., p. 331, pl. xxvii. fig. 11.

Ditto. (Wright) Egger, 1899, Foram. Kreidemergeln der Oberbayerischen Alpen, p. 135, pl. ii. fig. 3.

* *Sagrina aspera*, Marsson, 1878, Mitth. Nat. Ver. Neu-Vorpommern u. Rügen, Jahrg. x. p. 157, pl. iii. fig. 26 a-d.

Sagrina aspera (Marsson) Egger, 1899, Foram. Kreidemergeln der Oberbayerischen Alpen, p. 134, pl. xv. figs. 11, 12, 57.

The specimens agree with those described and figured by Wright under the name *Ramulina aculeata* d'Orbigny sp. Such specimens are abundant in most Chalk gatherings; they are invariably fragments, apparently of some comparatively large organism. It seems probable, therefore, that Wright's specimens have no connection with d'Orbigny's *Dentalina aculeata*, which, according to Brady, is "a common hispid Dentaline *Nodosaria*."* The cretaceous fossils should be known as *Ramulina aculeata* Wright.

Family VIII. GLOBIGERINIDÆ.

Globigerina d'Orbigny.142. (H-A) *Globigerina bulloides* d'Orbigny.143. (H-A) *Globigerina cretacea* d'Orbigny.293. (H-A) *Globigerina marginata* Reuss sp.

(Plate IX. figs. 1-3.)

Rosalina marginata Reuss, 1849, Verstein. Bohm. Kreid., pt. i p. 36, pl. xiii. fig. 47.

Ditto. (Reuss) Jones, 1853, Ann. Mag. Nat. Hist., ser. 2, vol. xii. p. 241, pl. ix. fig. 7.

Globigerina marginata (Reuss) Brady, 1884, Foram. 'Challenger,' p. 597, woodcut 17.

Ditto. (Reuss) Egger, 1899, Foram. Kreidemergeln der Oberbayerischen Alpen, p. 171, pl. xxi. figs. 12-14.

This species passes by insensible degrees into its ally, the commoner *G. Linneana* d'Orb., by the simple process of a thickening of the outer peripheral edge.

144. (H-A) *Globigerina Linneana* d'Orbigny.294. (H-A) *Globigerina æquilateralis* Brady.

(Plate VIII. figs. 11, 12.)

Globigerina æquilateralis Brady, 1879, Quart. Journ. Micr. Sci., vol. xix. N.S., p. 71.

Ditto. Brady, 1884, Foram. 'Challenger,' p. 605, pl. lxxx. fig. 18-21.

Ditto. (Brady) Egger, 1899, Foram. Kreidemergeln der Oberbayerischen Alpen, p. 169, pl. xxi. figs. 9, 11, 21, 22, 23.

Recorded also by Chapman from the Chalk of Taplow.

* See Brady, 1884, Foram. 'Challenger,' vol. i. p. 587.

EXPLANATION OF PLATE XI.

Fig. 1.—*Ellipsoidella pleurostomelloides* sp.n. × 100. Specimen (attached to chalk matrix) laid open to show internal tube.

,, 2.—Ditto. Ditto.

,, 3.—*Pleurostomella subnodosa*. Facsimile of Reuss' figure.



FIG. 1.



FIG. 2.



FIG. 3.

Orbulina d'Orbigny.295. *Orbulina universa* d'Orbigny.

Orbulina universa d'Orbigny 1839, Foram. Cuba, p. 3, pl. i. fig. 1.

Ditto. (d'Orbigny) Brady, 1884, Foram. 'Challenger,' p. 608, pl. lxxviii. pl. lxxxi. figs. 8-26, pl. lxxxii. figs. 1-3.

Ditto. (d'Orbigny) Egger, 1899, Foram. Kreidemergeln der Oberbayerischen Alpen, p. 173, pl. xxi. figs. 46, 47.

The solitary specimen which we have referred to this species is somewhat doubtful. It could with equal certainty be assigned to the arenaceous isomorph *Thurammina papillata* (Brady), as the surface bears several minute papillæ, which may, however, be adventitious. *T. papillata* has been recorded from Jurassic beds in Switzerland, but apparently not from the Chalk.

Sphæroidina d'Orbigny.296. *Sphæroidina bulloides* d'Orbigny.

Sphæroidina bulloides d'Orbigny, 1826, Ann. Sci. Nat., vol. vii. p. 267, No. 1. Modèle No. 65.

Ditto. (d'Orbigny) Brady, 1884, Foram. 'Challenger,' p. 620, pl. lxxxiv. figs. 1-7.

Ditto. (d'Orbigny) Egger, 1899, Foram. Kreidemergeln der Oberbayerischen Alpen, p. 173, pl. xxi. figs. 29, 30.

Family ROTALIDÆ.

Sub-family 1. Spirillininae.

Spirillina Ehrenberg.149. (H-A) *Spirillina limbata* Brady.

(Plate IX. figs. 4, 5.)

There does not appear to be any previous record of this species from the Chalk, except the one in Heron-Allen's "Prolegomena."

Sub-family 2. Rotalinae.

Discorbina Parker and Jones.153. *Discorbina turbo* d'Orbigny.*Truncatulina* d'Orbigny.176. (H-A) *Truncatulina lobatula* Walker and Jacob.180. (H-A) *Truncatulina Haidingerii* d'Orbigny.

(Plate IX. figs. 6, 7.)

297. (H-A) *Truncatulina cordieriana* d'Orbigny sp.

Rotalina cordieriana d'Orbigny, 1840, Mém. Soc. Géol. France, vol. iv. mém. 1, p. 33, pl. iii. figs. 9-11. Facsimile in Science Gossip, 1870, p. 108, fig. 117.

Ditto. (d'Orbigny) Egger, 1899, Foram. Kreidemergeln der Oberbayerischen Alpen, p. 158, pl. xx. figs. 16-18.

Recorded in H-A as *Pulvinulina Cordieriana* d'Orbigny.

182. (H-A) *Truncatulina ungeriana* d'Orbigny sp.

(Plate IX. figs. 8, 9.)

Anomalina Parker and Jones.

185. (H-A) *Anomalina ammonoides* Reuss.

Pulvinulina Parker and Jones.

188. (H-A) *Pulvinulina punctulata* d'Orbigny.

192. *Pulvinulina Hauerii* d'Orbigny.

194. (H-A) *Pulvinulina truncatulinoides* d'Orbigny sp.

Recorded in H-A under its synonym *P. micheliniana* d'Orb. sp.

198. (H-A) *Pulvinulina elegans* d'Orbigny.

Rotalia Lamarck.

201. (H-A) *Rotalia orbicularis* d'Orbigny.

202. (H-A) *Rotalia soldanii* d'Orbigny.

203. (H-A) *Rotalia exsculpta* Reuss.

(Plate IX. figs. 10-12.)

298. (H-A) *Rotalia clementiana* d'Orbigny sp.

Rosalina clementiana d'Orbigny, 1840, Mém. Soc. Géol. France, vol. iv. mém. 1, p. 37, pl. iii. figs. 23-25. Facsimile in Science Gossip, 1870, p. 155, fig. 140.

Family X. NUMMULINIDÆ.

Sub-family 2. Polystomellinae.

Nonionina d'Orbigny.

208. *Nonionina depressula* Walker and Jacob sp.

Not previously recorded from the Chalk.

209. *Nonionina umbilicatula* Montagu sp.

Recorded, under its synonym *N. soldanii* d'Orb., by Egger from the Bavarian Chalk.

213. *Nonionina boucana* d'Orbigny.

Recorded by Egger from the Bavarian Chalk.

XII.—*What did our Forefathers see in a Microscope?*

By EDWARD M. NELSON.

(Read April 20th, 1910.)

It is a question of some antiquarian interest what in pre-achromatic times did our forefathers see in a Microscope. In 1664 Samuel Pepys gave 5*l.* 10*s.* for a Microscope, and said that "it was a great price for a curious bauble," but little did he think that two and a quarter centuries later ten times that amount would be paid for a Microscope-stand only, and five times as much for one object-glass. Leaving, then, the "bauble" as something too dreadful for contemplation, the question before us is what sort of image would be seen in a Microscope of the highest type constructed before 1825?

There were dioptric and catadioptric Microscopes in those days, the dioptric being either single or double, or, as we should now say, simple or compound, the catadioptric being always compound.

A catadioptric Microscope would now be called a reflecting Microscope, but formerly the term reflecting meant a Microscope having attached to it a mirror solely for purposes of illumination, and this, quite independently of its being either dioptric or catadioptric. We have, therefore, to investigate three kinds of instruments, viz., simple and compound dioptric, and compound catadioptric Microscopes.

Of old Microscopes, one of the best was that designed by Dr. Smith; it was catadioptric, and, consequently, achromatic. It is fully described by its author in his "Complete System of Optics," 1738 (pp. 87-97, plates 14 and 15 of the Remarks), a learned and excellent work which has been freely copied. The description is given at length in old optical terms, so a translation into those in modern use is necessary. Dr. Smith designed and described four of these instruments (p. 91), of which that one numbered IV. he had had made some years before the other three were computed. He says, "I found it performed nearly as well in all respects as the very best refracting Microscopes, and do not doubt but it might have excelled them had it been more exactly executed according to the proposed dimensions in the IV. column; where the angle of aberration, being but 6' 15", is above three times less than the like angle in the best refracting Microscopes: and since the angle of aberration of 39" in the III. column is near ten times less than that of the IV., we have reason to expect that a Microscope, exactly executed according to those dimensions, will far excel any other yet invented."

The Microscope has a small convex speculum with a hole in it, close to the back of which the object is placed; the rays pass from the object through the hole in the convex speculum, and, falling upon a concave speculum, are reflected on to the convex speculum, which reflects them back again through a hole in the centre of the concave speculum to the eye-piece. In brief, it is, as Dr. Smith points out, a Cassegrain telescope (invented 1672), with the object placed close to the back of the convex speculum.

The history of the catadioptric Microscope is as follows:—A simple form with one concave speculum was proposed by Sir Isaac Newton, but not made. Smith's is really the first, because "The complete System of Optics" was published in 1738, and No. IV. Microscope was made some years before the other three described in that work were computed. Its date may, therefore, be as early as 1730. Barker's catadioptric Microscope (1736) was a Gregorian telescope adjusted to view near objects. A Gregorian used as a Microscope in this manner is merely a toy—a megalascope, or magnifying glass, nothing more, because the object must be placed a considerable distance behind the concave mirror. In order to turn a Gregorian into a Microscope, it would be necessary to drill a hole through the centre of the concave speculum and place the object just at the back of the hole. The aberrations, which in this form are additive, would be large, and the image very bad. The Newtonian method has practical difficulties: (1) If the object is inside the tube, there is the difficulty of illuminating it. C. Tulley showed how this could be done for opaque objects, and W. Tulley for transparent ones.* A Newtonian supplied with both these devices might do very well. Professor Amici's plan was to use a Newtonian telescope with its flat, merely reversing the positions of the eye and the object.† The object was placed outside the tube at the point where the image in a Newtonian telescope is formed, the eye-piece being placed in the mouth of the much lengthened tube. At first sight, no objection would be perceived in this method; but, if it is examined more closely, it will be noticed that the flat in an astronomical telescope obscures only a small part of the speculum, where the ratio of aperture to focus is about 1 to 6, but as the ratio would have to be 1 to 3 for microscopical purposes, the flat would require to be so large that it would cover up too much of the speculum. (2) The objection to the Newtonian Microscope is that the aberration of the single concave mirror must be neutralized by departing from a spherical curve. Dr. Smith's, therefore, is the only real practical solution for a catadioptric Microscope: the aberration of one mirror balances that of the other. The chief defect is the absence of any means of illuminating an opaque object; this, however, might be remedied.

But to return to Dr. Smith's four Microscopes, it does not seem

* *Micrographia*. Goring and Pritchard, 1837, pl. 1, figs. 26, 27.

† *Tom. cit.*, fig. 28.

that any other besides No. IV. was actually constructed. No. I. is very similar to No. IV. in design, so also is No. II. to No. III., but between the pairs there is a slight variation. The power of all four is the same, but the aberrations in the order of their numbers are proportional to the following figures: 3.75, 3.82, 1, and 9.6. Therefore No. III. is the best, and No. IV. the worst. The radius of the concave of No. IV. is 2.064; with this single exception the radii of all the other mirrors is 2.0 in. The distances between the mirrors is as follows: 1.6, 1.6419, 1.6558, and 1.6712. The distances of the object from the concave mirrors are 1.7143, 1.7184, 1.7184, and 1.7719. The diameters of the concave mirrors measure 1.1 in., and the convex 0.45 in. These data are sufficient to enable anyone either to make any of the four instruments or to calculate their aberrations. These four Microscopes possess not only much brass and glass, but also mathematical interest, consequently they have been largely copied in other scientific works, but it does not appear that some of their more salient features have ever been noticed. Thus, if Nos. II. and III. are examined, it will be seen that No. II. has nearly four times as much aberration as No. III. Wherein, then, does the variation lie that causes this difference in the aberration? A difference of 0.0139 in a distance between the mirrors, which exceeds $1\frac{1}{2}$ in., is the only optical difference between these Microscopes, and it is hardly probable that a quantity so small should have so profound an effect.

A minute examination of No. III. was then undertaken, and a small slip was discovered in the learned doctor's work. In fig. 52

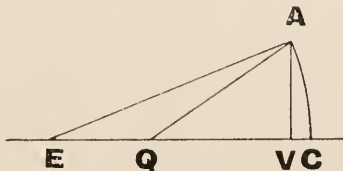

FIG. 52.

let EC be the axis, and AC the upper half of the concave mirror, EC its radius 2 in., Q the object, and QA a ray meeting the mirror in A, from which point the perpendicular AV is dropped. We have given, the angle A E V $15^{\circ} 47'$, EA 2 in., and C Q 1.7184 in.

Now $AV = r \sin A E V$
 and $CV = r (1 - \cos A E V)$
 and $VQ = CQ - CV$
 Then $\tan A Q V = \frac{AV}{VQ}$
 and $A Q V = 18^{\circ} 19' 11'' \cdot 5$

the aperture of the lens being N.A. 0.314; Dr. Smith, however, gives it as $18^{\circ} 26' 6''$, or $6' 54''$ too much. In No. II. the error is the

same, but in No. I. it is $7' 1''$, and in No. IV. $6' 55''$; in this last Microscope there is also an error in the ver. sin of 0.00239 .

Dr. Smith's angle of aperture, $\tan \frac{1}{3}$, is common to all the four Microscopes.

Under these circumstances, it seemed better to make an independent examination of the Microscope, No. III. being selected for that purpose. Two sets of calculations were made, one analytical, the other trigonometrical—the results being that the final aberration by the trigonometrical method* is $+0.0017$, by the analytical $+0.0005$, while that by Dr. Smith is -0.001 . No. III. Microscope is, therefore, aplanatic as well as achromatic. We are now in a position to see what this Microscope was really like. Its objective, which consisted of two mirrors, had an equivalent focus of 0.604 (a little higher than $\frac{2}{3}$), and the very large optical index of 19.0 . The tube-length was so short that the effectual power of the objective was reduced to 5.3 ; the eye-piece was very deep, its power being 71 ; the combined power was therefore 375 , or, in Dr. Smith's terminology, 300 , as he used an 8-in. eye-point.

This Microscope is quite unique, inasmuch as the object was kept at a fixed distance from the objective, the focusing being performed by the eye-piece alone. The mechanical arrangement was that of a direct-acting screw, as was usual in Microscopes of that date, but herein lies the ingenuity of the device, because the objective forms an optical lever to slow down the effect. In the modern Microscope a lever of some sort is placed between a direct-acting screw and the objective to slow down the motion, because its effect is multiplied by the optical action of the objective; in Dr. Smith's the optical action of the objective is in the contrary direction, and so the effect of the movement of the eye-piece is reduced. It was not considered necessary to work out any of the other three Microscopes, as this one proved so satisfactory. We may therefore pass at once to the compound dioptric Microscope.

The optical efficiency of this instrument reached its zenith in the hands of Benjamin Martin. After Martin's death Adams copied Martin's optical parts, and his successor, Jones, carried on the same form right up to the introduction of achromatism. Martin's Microscope had an eye-piece with a double eye-lens and a field lens; at the top of the "pipe," or, as we should say, "nose-piece," there was a biconvex † lens of $5\frac{1}{2}$ -in. focus to do duty as a back lens to the six non-achromatic single equiconvex object-glasses. These old opticians had found out precisely the largest aperture that might be given to a single biconvex lens before the fog and chromatic fringes became too pronounced. The following list gives the

* Calculated to the first decimal place of a single second of arc.

† That in my Microscope is not equiconvex.

measurements of the six objectives taken from an excellent example* of one of these Microscopes:—

Objective.	Focus.	Initial Power.	N.A.	O.I.
No. 6	1.44	6.94	0.057	8.2
„ 6a	1.26	7.96	0.043	5.3
„ 5	1.16	8.6	0.064	7.4
„ 4	0.62	16.0	0.08	5.0
„ 3	0.51	19.4	0.11	5.5
„ 2	0.44	22.6	0.15	6.6
„ 1	0.195	51.1	0.197	3.8
„ 1a	0.136	73.6	0.183	2.5

Whole Microscope, with No. 6 and back lens, focus 0.33, power 29.9; without back lens, focus 0.29, power 34.1. Those marked (a) were measured with the 5½-in. focus-lens removed from the top of the “pipe.” The action of this lens, by reducing the power and increasing the aperture, increases the optical index, and consequently improves the Microscope.

Jones added to Martin’s Microscope a biconvex lens of 2-in. focus as a substage condenser,† and in this condition the dioptric compound Microscope remained until it was achromatised. The origin of the “pipe” is of interest. It first appears in the “New Constructed Double Microscope,” made by Cuff, 1744, for the purpose of adapting Dr. Lieberkühn’s mirror‡ to a compound Microscope, and it was the first compound Microscope to have this mirror.§ Benjamin Martin, in 1770, copies this form of “pipe” and lieberkühn, and places his back lens at the top of it. However, in 1776, the “pipe” is discarded, the end of the body tube is made conical with an ornamental curve, the back lens is retained at the base of the cone, and the lieberkühn is mounted upon a separate holder. Adams, in 1771, published a book of plates of Microscopes in which Cuff’s models are figured. We may, therefore, assume that Cuff had either died or retired from business in 1770. The Microscopes made by Benjamin Martin with Cuff’s “pipe” may be dated between 1770 and Martin’s death in 1782. The screw on Martin’s “pipe” passed on to Tulley, who used it for the first achromatic objective of the Lister-Tulley Microscope|| of 1826, and from thence to James Smith, from him to Richard Beck, and from him to the Microscopical

* Benjamin Martin (*circa* 1770). See this Journal, 1898, p. 474, fig. 81.

† See this Journal, 1899, p. 326, fig. 73 (unsigned, but exactly similar to Benjamin Martin’s “New Universal Microscope,” 1776). Presented to the R.M.S. by the late Dr. Dallinger.

‡ Called after Dr. Lieberkühn, because, in 1740, he brought it into general use. It had been previously described by Descartes (1637), and used by Leeuwenhoek, *circa* 1673.

§ Journ. Quekett Micr. Club, 1898, ser. 2, vii, p. 116, fig. 23. Presented to the R.M.S. by Mr. C. L. Curties.

|| See this Journal, 1900, p. 551, fig. 146.

Society of London* ; now it is the universal screw. To-day I screwed a "pipe" of Benjamin Martin's No. 1 Microscope into a Zeiss nose-piece, and it fitted perfectly.

With regard to Dr. Lieberkühn, who invented the projection Microscope, the following passage may be of interest ; it is taken from a rare work by John Cuff, dated "Feb 17th, 1743. At the sign of the Reflecting Microscope directly against † Serjeant's-Inn Gate in Fleet-Street, London."

"As Gentlemen are frequently making Enquiries concerning the Invention and Improvement of the Solar Microscope, which is now Universally allowed to be the most Agreeable and Entertaining Microscope yet known, as well as the most capable of making valuable Discoveries, I hope it will be excusable, if, in Order to satisfy their Curiosity, and prevent their being impos'd on by false Pretences, I give a short but true Account thereof.

"This Instrument is not of English Invention, nor was ever known amongst Us, till about three Years ago, when Dr. Liberkuhn, a Gentleman of Prussia, came from Holland hither, and brought it over with him : But, whether he met with it in his Travels, or was himself the Inventor, I shall not pretend to determine. He was however, most assuredly, the first Discoverer of it to Us ; and being an extraordinary good Mechanic and Workman, he ground and set his own Glasses with a great deal of Accuracy, and made the whole Apparatus with his own Hands.

"Being of a communicative Temper, he shewed this curious Contrivance to several Gentlemen and Workmen ; nor was it long before Instruments were made in Imitation of His. In all these, the Tube thro' which the Sun's Rays pass on to the Object, was fastened to a Ball and Socket, in Order to direct it, as much as possible, against the Body of the Sun as it moves along the Heavens. But the Instrument, notwithstanding, could be employ'd a few Hours in a Day only : Which Inconvenience made the Invention less valued than it deserved. To amend this, permit me with all Submission to declare, that Myself was the fortunate Person, who (from the ingenious Hint of a kind Friend that introduced me to Dr. Liberkuhn) began to consider, that a plain Looking-Glass could Reflect the Sun's Rays thro' the Tube placed Horizontally, at any Time of the Day, when the Sun is a few Degrees above the Horizon, or even at its Highest Altitude. And, from that Consideration, we first contrived an Apparatus with such a Looking-Glass affix'd thereto. Since which Time being Honoured with the Favour, Advice, and Assistance of several Gentlemen of the Greatest Understanding and Abilities, I have been thereby enabled to alter and improve this Instrument, from Time to Time, till it arrived at the degree of Perfection it appears to have at present.—JOHN CUFF."

* *Trans. Mier. Soc., London, vii. 1859, p. 92.*

† This means opposite to, and not alongside of.

All will probably endorse the opinion of the learned Dr. Robinson, of Armagh, concerning the non-achromatic projection Microscope—viz. that it was “generally so indistinct that it is fit only for amusing ladies.” He, however, suggested a great improvement by the employment of a four-lens terrestrial telescope eye-piece as the projecting lens.

It is difficult to understand why such an excellent Microscope as that of Dr. Smith’s did not become more popular; the cause may be traced in part to Dr. Lieberkühn’s illuminator. The idea in those days was to provide the public with a Reflecting, Aquatic and Opaque Microscope. These terms mean: Illuminated by a mirror; body capable of traversing the stage; supplied with a Lieberkühn. Now Dr. Smith’s Microscope was none of these; it could only be used for the examination of transparent objects. Dr. Lieberkühn’s opaque Microscope took the then small microscopical world by storm, and continued to be very popular until Dr. Smith’s excellent Microscope had been forgotten. There was, too, another reason why it did not come into more general use; it possessed a large aperture, which required the mirrors to be very accurately worked and mounted; therefore, if the instrument had to compete in price with roughly made contemporary Microscopes, the seller’s profits would have to be considerably reduced. An examination of old Microscopes shows the optical and mechanical work to be of the roughest kind; in many instances the lenses have only been imperfectly polished, and they are mounted in roughly turned out cells, fitted with badly cut screws. The profits made on the sale of those instruments must have been very high. So long as the opticians could easily obtain these returns they were not anxious to introduce a Microscope that would not only require more skilful workmanship, but when done would emphasize the rottenness of the image in the ordinary non-achromatic compound Microscope which they were selling with so large a profit; so they, in their worldly wisdom, agreed to let sleeping dogs lie.

A number of Dr. Smith’s Microscopes were made (*circa* 1772) by Sir W. Herschel at Bath; Sir D. Brewster,* in 1837, states that he has one of them, and gives the measurements of its parts, which differ very much from any of the formulæ given by Dr. Smith; he leaves out, however, the focus of the convex mirror, which omission renders all the other data simply useless; but the focus of the concave mirror was more than twice as great as any of Dr. Smith’s. Brewster says that “it performs wonderfully well, though both of the specula have their polish considerably injured; it shows lines on some of the test objects with very considerable sharpness.” Coddington,† in 1830, says that he had never seen one of Smith’s

* Ency. Brit., art. Microscope.

† Coddington’s Optics, pt. 2, p. 66 (footnote).

Microscopes; he gives all the data of No. III., and says that "It will be observed that there is no great obliquity in either reflexion; and I should imagine that the image formed in such an instrument, if well executed, would be very distinct."

We now pass on to the simple dioptric Microscope, which consisted of a single equiconvex lens much stopped down. Some of these had very short foci; one made *circa* 1760 measured $\frac{1}{2}\frac{1}{5}$ in., and the aperture was a mere pin's point. Some have expressed astonishment at those astronomers who used the aerial telescope of some 200 feet focus, mounted without a tube at the top of a pole; but allow me as a microscopist to express equal astonishment at those early naturalists who worked with very high power simple Microscopes.

Microscopes in those days were often sold as "single" and "double," which means that in the same box with the compound Microscope a set of simple lenses was supplied as well. The Benjamin Martin Microscope referred to above had six of these simple Microscopes. As to the low powers, there is no difficulty in understanding how to use them; the compound body is unscrewed from the limb, and the simple Microscope takes its place; but with the high powers a difficulty arises because the focal point of the minute lens is inside a sort of cup (not a *lieberkühn*) on one side, and in a tube on the other; it is, therefore, quite impossible to focus it either on a modern glass mount or upon one of the ancient ivory sliders; an object held in the stage tweezers might be focused inside the cup, but then how is it to be illuminated? In a Cuff's Microscope the simple lenses are mounted in *lieberkühn*s, but the lenses are placed at the end of a small dome, which brings the lens to the level of the rim of the *lieberkühn*, therefore with one of these an ordinary slide may be examined.

Strictly speaking, we have brought the investigation of the three principal forms of Microscopes up to the date which was mentioned at the beginning, viz., that of the achromatisation of the Microscope; we ought, however, to be allowed some little latitude for overlap, because achromatism took a little while to become established, during which time not only did the old forms remain, but great improvements were effected in the non-achromatic Microscope. The greatest of all these improvements was the introduction of Wollaston's doublet in 1829. The ratio of the foci of these lenses was 3 : 1, placed at their best distance apart as discovered by trial; in brief, it was a Huyghenian eye-piece turned up-side down.* Later it was found that a distance of the lenses apart equal to the difference of their foci gave the best results, but it seemed that a precise ratio of 3 : 1 for their foci did not matter much. Coddington

* Wollaston was dying when he published the account of this Microscope, and said that his publication was premature, as his experiments with it were not completed.

(1830) gives 3 to 1 and $1\frac{1}{2}$ for their distance apart, which was probably found to be the best proportions. It was stated that an aperture as high as 0.42 N.A. was obtained, but I have measured nothing over 0.3 N.A.

Wollaston's Microscope had a plano-convex lens of about $\frac{3}{4}$ in. focus for a substage condenser. It was a very simple instrument, quite small, the mechanical part being a brass tube 1 in. in diameter, and about 6 in. long; at the lower part there was an aperture, and inside a plane mirror was fitted; at the bottom there was a screw to screw it either into a box lid for a foot or into a screw-clamp for the edge of a table, just like his camera-lucida. On the top of the tube was a small stage suitable for small slips, say $1\frac{1}{2} \times \frac{1}{2}$; a rackwork coarse-adjustment was provided for focusing the doublet. Subsequently this instrument was improved, its most perfect form being attained in Vallentine's Microscope, made in 1831 by Andrew Ross.* This had sprung coarse- and fine-adjustments; the fine-adjustment head was graduated for the first time, a rectangular mechanical stage, the limb holding the doublet traversed the stage by means of a rack-and-pinion, and could also rotate upon a conical pin. Subsequently it was found that these doublets made very good object-glasses for a compound Microscope, so a compound body was fitted to Vallentine's Microscope, and thus Andrew Ross's earliest model of a compound Microscope was formed. Vallentine's Microscope was afterwards simplified: the fine-adjustment and the mechanical stage were removed, but the sprung coarse-adjustment and the rackwork traversing movement to the arm were retained; it was with one of these simplified instruments † made in 1839 that the experiments mentioned in this paper were carried out. Owing to the excellent manner in which this coarse-adjustment is sprung (a method adapted from a Microscope made by Powell for C. Varley), it works to-day as well as ever it did—it is smoother, steadier, and softer than any coarse-adjustment now turned out, either here or abroad.

Two improvements were made in the optical part. The first was in 1831 by J. Holland, who broke up the front lens into two, thus making the first duplex front. The foci of one of Holland's triplets are $\frac{1}{5}$, $1\frac{1}{5}$, and $2\frac{1}{5}$ in., all planos; the two last are in contact, and between these and the back lens there is a diaphragm. It was stated that the triplets performed better than the doublet, and that an aperture as large as 0.54 N.A. had been obtained. The last improvement was by Chevalier, who, by making the lenses of equal foci, with the lower lens of greater aperture than the upper, increased the resultant aperture and much improved the doublet.‡

* See this Journal, 1900, p. 425, fig. 104.

† Tom. cit., p. 428, fig. 109.

‡ The date of Chevalier's improved doublet has not been determined: it may have been about 1842. One of them is signed "Arthur Chevalier. Palais Royal."

One of these measures 0·53 N.A. This was the last effort to improve the non-achromatic dioptric Microscope.

Having described at length the three forms of Microscopes, the question remains: What did their users see through them? We have examples of simple and compound dioptric Microscopes at hand, and therefore with regard to these we may see for ourselves; but Dr. Smith's catadioptric is such a rare form that I have never even seen one, nor known anybody that has, so we must form an estimate of its capabilities from the reports of those who have used it, and from a careful examination of the formula upon which it was constructed.

Taking the dioptric Microscope first, it has been said that the compound form is inferior to the simple. It is possible that this saying has arisen owing to the numerous discoveries made by the famous Leeuwenhoek (1673) with his simple Microscopes. It is true that for dissecting work single lenses, of powers from that of a watchmaker's eye-glass to a $\frac{1}{2}$ -in. focus, are more suitable than any compound Microscope; nevertheless, for an observing instrument there can be no question that the compound Microscope not only gives far better images, but also is much more easy to work with, because the working distance is greater and the field larger. A careful comparison was made between the Benjamin Martin compound with a No. 1 lens and Cuff's $\frac{1}{25}$. Both resolved 15,000 ruled lines to the inch, but the resolution with the compound was much stronger and sharper than with the single. A coarse *Navicula lyra* (17,000 per inch) was shown indifferently resolved by both, but the compound gave the better image. Neither would dot that beautiful and easy diatom the *Actinocyclus Ralfsii**; with

* Probably the two most beautiful of all microscopical objects are the *Actinocyclus Ralfsii* (the blueish rather than the greenish variety), and the eight rayed *Aulacodiscus Kittonii*, but these, like everything else, require to be properly shown. The *Actinocyclus Ralfsii* should be viewed in daylight with a low power of about 0·3 N.A., and a low power achromatic condenser. If it is too much resolved the beautiful colour fades, if it is not sufficiently resolved the fine ray effect is not seen to advantage; there is a precise point between these two where the image is just right. The *Aulacodiscus Kittonii* requires different treatment, only a very fine lens of about 0·65 N.A. will show this extraordinarily beautiful diatom properly. The same low-power condenser is used (an achromatic $\frac{1}{10}$, used with its top off, focus 0·8), with daylight, and the plane mirror as before. The substage is racked up until the window-bars are in focus, and a stop about half an inch in diameter is placed in the holder. This stop should be of such a size that it will just give a dark ground with an object-glass of 0·3 N.A., and therefore it will not give a dark ground with an object-glass of 0·65 N.A. The important part is the lens adjustment, which will be found to be extremely sensitive with this kind of illumination, one-tenth of an inch alteration of tube-length will, with a critical eye, make all the difference between a good or a bad image. There is a peculiarity in regard to this method of work which must be explained at some length. There are two images, which, for convenience, may be called the positive and negative images; in the positive image the areolations are darker than the silix, but in the negative the silix is darker than the areolations. No microscopist, however expert, if shown either of these images, would suspect anything wrong with them. They, although exquisitely sharp, are both false images! The method of detecting this is by measuring the tube-length: that

the single it was bathed in coloured fog, but the compound gave a better picture of it than one would have expected. Of course, chromatic aberration and spherical fog were there, and could be easily found if sought out, but looking at the diatom in an ordinary way these defects were by no means obtrusive.

The minute hairs on the proboscis of the blow-fly were seen—blunt and fluffy, it is true—but the *Podura* was quite beyond either of them. No amount of words or of writing can convey to another an idea of the quality of an image, therefore it will be better to give a comparison with some modern apparatus, so that any one may see for themselves the sort of image an attempt has been made to describe. If any one will take a Zeiss aa and a 5 eye-piece, they will see an image which will represent, as closely as the circumstances will permit, the utmost that could be made out of any object by our forefathers with a compound dioptric non-achromatic Microscope of the best kind. Of course, the brightness and beauty of the image given by that remarkably fine semi-apochromat will not be seen in the old instrument, but so far as making out detail or structure is concerned, the two images will be identical.

With regard to Dr. Smith's catoptric Microscope, if we substitute for the aa the Zeiss 24 mm. apochromat, we shall see an image probably not so very dissimilar to that given by Dr. Smith's reflector. The detail resolved, and the achromatism in both would be the same, but the reflector could not possibly reproduce the brightness of image given by that beautiful apochromat. With daylight illumination and only the concave mirror striae would be

for the positive image is 10 in., while that for the negative is 8·8 in. If the manipulator does not know the correct image, there is a way of finding it out, thus: Place the top on the condenser, and increase the size of the stop to $\frac{6}{10}$, the ground will now be dark, and, consequently, there will be only one point where the lens is in adjustment, in this instance 9·2 in. Next remove the top lens from the condenser, replace the $\frac{1}{2}$ -in. stop without disturbing the lens adjustment. The image now will hardly be so striking as either the positive or negative images just described; but it will be the true picture, the areolations are not quite so black, the silix is not quite so sparkling white, nor of such tenuity, but, if carefully considered, it will be perceived that the lens has been adjusted upon the actual silix. If the former had been true positive and negative images there would have been very little, if any, alteration of lens adjustment required. The presence of 1·2 in. of alteration in the adjustment is an indication, to any one acquainted with the mere alphabet of microscopy, that something is wrong. It will be asked, if the true image is found out by means of dark ground illumination, why alter it, and why not show the diatom as it is upon the dark ground? A very natural question. The reply is that the valve has some thickness, therefore with a lens of the aperture required to show this diatom properly there will be much super-amplification of those parts which are out of focus. This greatly interferes with the beauty of the image, and gives rise to a mist, or fog, which the unskilled might take for spherical aberration. Upon the semi-dark ground the mist is, of course, there all the same, but it cannot be seen. This method of working upon a semi-dark ground is a very good one, and will be found to be of much practical use even by a biologist in his rough and ready work.

seen on the fine *Navicula lyra* (24,000), the *Actinocyclus Ralfsii* would be dotted, and the exclamation marks seen on a coarse *Podura* (24,000). When an elementary form of condenser* was used more could be done: striæ could be seen on *Pleurosigma formosum* (25,000), *Nitzschia scalaris* (26,000), *Doryphora Bocckii* (27,000). It will be noticed that with the apochromatic 24 mm. objective, on account of its larger aperture, it matters a good deal if a condenser is used or not, but with the lower-angled aa there is not this difference in the image. It is for this reason that a condenser is so seldom to be seen on an old Microscope. The resolutions with these modern object-glasses were not pushed, they were purposely used in a rough and ready way. It should be specially noted that Dr. Smith's catadioptric had a potentiality which other Microscopes did not possess. If, for instance, that form of Microscope had been taken up, it would have been quite easy to have computed and made others of greater aperture. There can be no doubt that even in its original form it was by far the best Microscope of pre-achromatic times, for, as we have seen, it stood to other ancient Microscopes in the proportion of apo. 24 mm. to semi-apo. aa.

Finally, we come to the Wollaston doublets, which were invented after the Microscope had been achromatised. The proboscis of a blow-fly was examined with a single equiconvex, a doublet, and a modern achromat, all of $\frac{1}{4}$ in. focus; the doublet was just about as much better than the single, as the achromat was better than the doublet; therefore, the doublet may be said to occupy a mean position between the two. As the powers increase, the single lens is rapidly left far behind. A doublet of $\frac{1}{2}$ -in. focus will, when a condenser is used, resolve the *Pleurosigma formosum*, a fine *Navicula lyra*, a *Nitzschia scalaris*, and a strongly marked *Podura* scale; a Chevalier doublet of the same power will resolve the *Doryphora Bocckii* as well. The Wollaston doublet (made by Powell) is a little sharper, but that by Chevalier is the stronger resolver of the two. Without a condenser they show the *Actinocyclus Ralfsii* and the coarse *Navicula lyra*. So there is not much to choose between these doublets and Smith's catadioptric Microscope.

We are now in a position to understand the true condition of the microscopical world in pre-achromatic days. Smith's excellent Microscope was practically unknown, and all that could be seen was the best that a good compound Microscope of the Benjamin Martin type could show. Just after the introduction of achromatism the doublet was invented, which surpassed the Benjamin Martin Microscope, and possibly would have equalled a Smith No. III. if it had been made.

In conclusion, we have some definite work which users of

* Dr. Smith's Microscope had an equiconvex lens condenser.

pre-achromatic Microscopes have left behind them, and which may be put to the proof by similar work done in the achromatic times. I allude to the measurement of the red corpuscle in human blood.

Dr. Jurin made it $\frac{1}{1940}$ in.; Leeuwenhoek confirmed this measurement; Dr. Wollaston $\frac{1}{5000}$ in.; MM. Prevost and Dumas $\frac{1}{4076}$ in.; Captain Kater $\frac{1}{4000}$ in.

The measurement by the achromat is $\frac{1}{3390}$ in. Dr. Jurin's measurement is 75 p.c. too large; Dr. Wollaston's 32; M. Prevost's 17; and Captain Kater's 15 p.c. too small.

NOTE.

Note on the use of the Mercury Vapour Lamp in observing the Rings and Brushes in Crystals.

By E. B. STRINGER.

WHILST observing the rings and brushes in crystals with the monochromatic sodium flame, it occurred to me that the light of the mercury vapour lamp might be specially suitable for the purpose, since it yields monochromatic light of several refrangibilities at once. (Those who have seen its spectrum will understand my meaning.) This actually proved to be the case. The brilliance, and especially the definition with which they are shown, is very remarkable. I know little of petrological work, but much of it, I believe, consists in the examination of these rings and brushes, and the lamp might prove to be of great value for the purpose.

Postscript.

Since writing the above, it occurred to me that other interesting experiments in interference might be made with the same light.

I find that whilst it is impossible to see the Newton's rings in my 3 in. telescope objective by ordinary illumination, yet with the mercury light (diffused by the interposition of a piece of ground glass) they appear with the greatest distinctness, and of wonderful fineness and delicacy, extending to the extreme edge of the lens.* This should prove of value in adjusting pairs of lenses.

The interference colours in a vertical soap-film are also very beautiful when seen in this way, and so delicate as to require examination with a magnifying glass.

* To see the rings by transmitted light it is best to look down upon a piece of white paper, illuminated by the lamp.

SUMMARY OF CURRENT RESEARCHES
RELATING TO
ZOOLOGY AND BOTANY
(PRINCIPALLY INVERTEBRATA AND CRYPTOGAMIA),
MICROSCOPY, ETC.*

ZOOLOGY.

VERTEBRATA.

a. Embryology. †

Determination of Sex.‡—Russo has made some very interesting experiments on the determination of the female sex in rabbits. He dosed rabbits with lecithin, administering it in various ways. He injected it into the peritoneal cavity, or subcutaneously, or introduced it through the mouth. The result was an accumulation of deutoplasmic material in the ovarian follicles and in the oocytes. Animals treated in this way, and subsequently mated, had always more female than male offspring. Sometimes all the offspring were female.

In the normal ovary Russo distinguished two kinds of ova, some which are rich in nutritive material deposited in the zona pellucida and in the vitellus, and others which have little or none. In young rabbits of five or six months the ova have little vitelline material, no chromidial corpuscles, and a clear zona pellucida. This is a sign of deficient nutrition, and these very young ova tend to be male-producing. As the nutrition of the ovary improves with age the ova become better equipped with embryoplasmic material, and tend to be female-producing. The ovary is a very plastic organ, and by lecithin-treatment the number of female-producing ova may be increased. It may also be that lecithin-treatment of the males affects the sperms (in their mitochondrial apparatus) in a similar way.

The author gives an account of the germinal epithelium, the granulosa, the zona pellucida, and the chromatic bodies in the ooplasm. Statistics of the experiments and details as to the methods are duly submitted.

State of Ovary during Pregnancy.§—O. O. Fellner finds that from the histologist's point of view it is impossible to speak of a cessation of

* The Society are not intended to be denoted by the editorial "we," and they do not hold themselves responsible for the views of the authors of the papers noted, nor for any claim to novelty or otherwise made by them. The object of this part of the Journal is to present a summary of the papers *as actually published*, and to describe and illustrate Instruments, Apparatus, etc., which are either new or have not been previously described in this country.

† This section includes not only papers relating to Embryology properly so called, but also those dealing with Evolution, Development, Reproduction, and allied subjects.

‡ Studien über die Bestimmung des weiblichen Geschlechtes. Jena (1909) 105 pp. (32 figs.)

§ Arch. Mikr. Anat., lxxiii. (1909) pp. 288-305.

ovarian activity during pregnancy. Ripening of follicles does occur, but it is retarded, and only a few reach full ripeness. On the other hand, the internal secretory function not only continues, but is intensified.

Spermatozoa entering a Blastula.*—J. H. F. Kohlbrugge has pointed out that in the bat the spermatozoa may penetrate not only into the cells of the uterine mucosa, but may enter the "blastula" and the embryonic disk. In this way the male may have, he suggests, an influence on the embryo apart from amphimixis; but more facts are required before any speculation of this sort can be entertained.

Development of Blood.†—A. Maximow has studied this in embryos of rabbit, guinea-pig, cat, and other Mammals. The first blood-cells, arising in blood-islands and lying within vessels, are rounded, indifferent, mesoblast or mesenchyme cells, without hæmoglobin. They multiply by independent proliferation and also by continued segregation of endothelial cells in the primary vessels. From the outset many become primitive erythroblasts, which multiply independently, but gradually die out. The other primitive blood-cells remain without hæmoglobin, and take on the character of non-granular leucocytes or lymphocytes. From some of the progeny of these lymphocytes there arise the definitive red blood corpuscles—first erythroblasts and then erythrocytes. This goes on throughout life, in all places or organs where there are indifferent mesenchymatous migratory cells. The erythroblasts may also proliferate on their own account. Thus red blood corpuscles and white blood corpuscles arise in the same place and form the same cell-stock—the primitive blood-cells in the vessels of the *area vasculosa*.

Role of Nucleus in Heredity.‡—Oscar Hertwig returns to the defence of the hypothesis, which Strasburger and he stated in 1884, that the idioplasm is localised in the nuclear substances. In support of this much-discussed thesis he advances seven arguments, of which the three strongest are (1) the equivalence of ovum and spermatozoon as regards nuclear material; (2) the precise partition of nuclear substance in karyokinesis; and (3) the reduction processes by which an accumulation of nuclear substance is obviated.

Segmentation of Unfertilised Egg of Fowl.§—A. Lécaillon continues his study of this phenomenon. If the laid egg be left to itself the blastomeres which have been formed degenerate and the nuclear figures disappear. At the end of an hour there may be only one to be seen. In four days the nuclei have gone. If the temperature be raised the degeneration sets in with great rapidity.

Early Stages in Development of Rat.||—Victor Widakowich describes the formation of the "ovum-cylinder," the mesoderm, and the amnion, and discusses the characteristic inversion of the embryo from a dorsally concave to a dorsally convex state.

* Arch. Mikr. Anat., lxxv. (1910) pp. 519–21 (1 fig.).

† Op. cit., lxxiii. (1909) pp. 444–561 (4 pls.).

‡ Der Kampf um Kernfragen der Entwicklungs- und Vererbungslehre. Jena, (1909) 122 pp.

§ C.R. Soc. Biol. Paris, lxxviii. (1910) pp. 593–4.

|| Zeitschr. wiss. Zool., xciv. (1909) pp. 240–98 (3 pls. and 1 fig.).

Ossification of Human Lower Jaw.*—Alex. Low confirms his previous conclusion that each half of the lower jaw is developed in membrane as a single skeletal piece—the dentary. Meckel's cartilage takes only a slight part in the formation of the mandible, and does not give rise to the condylar cartilage.

Seal-embryos.†—H. W. Marett Tims gives an account of embryos of Weddell's seal (*Leptonychotes weddelli*). He notes that the period of gestation must be at least nine months; that the muscles as a whole show closer agreement with those of *Trichechus* than with those of *Otaria*; and that there is in the musculature some additional support for Mivart's suggestion of a Lutrine origin for the Phocidæ. An interesting point is the presence of what seems to be a vestige of an external ear in a very early embryo.

Development of Cranial Nerves in Birds.‡—J. Belogolowy continues his study of the development of the cranial nerves. He describes the histogenesis, and then applies his results to the much-discussed problem of the metamerism of the head. His conclusions agree in the main with those of Johnston.

Development of Blindworm.§—Ernst Meyer gives an account of the development of *Anguis fragilis*, from the appearance of the pro-amnion to the closure of the amnion, dealing particularly with the brain, the notochord, and the hypochordal ridge.

Oogenesis in Raiadæ.||—J. Maréchal and A. de Saedeleer discuss the development of the first oocytes in *Raia clavata*, describing, for instance, the synapsis or contraction of the chromatin mass.

Segmentation and Gastrulation in Lamprey.¶—L. Glaesner describes the segmentation of the egg in *Petromyzon fluviatilis*, the formation of the blastula, with its micromeres and macromeres, the gastrula-invagination, and the formation of the blastopore.

The same subject is discussed by Marc de Selys-Longchamps,** who has studied *Petromyzon plumeri*. He describes the blastula, the incomplete gastrulation, the "notogenesis" or concrescence, the formation of the mesoderm. He seeks to show that there is actual concrescence in this type, and that gastrulation, notogenesis or concrescence, separation of the mesoderm and of the axial structures, are not so much successive phases in development, as concomitant processes.

Development of Nephridium in Amphioxus.††—Robert Legros discusses this difficult problem. We cannot do more than indicate his general conclusions. The nephridium, the excretory organ of the second

* Journ. Anat. Physiol., xlv. (1909) pp. 83-95 (1 pl.).

† National Antarctic Exped. (Nat. Hist.), v. (1910) pp. 1-21 (2 pls.).

‡ Bull. Soc. Imp. Nat. Moscou, 1908, Nos. 3 and 4 (published 1910) pp. 325-537 (1 pl.).

§ Zeitschr. wiss. Zool., xciv. (1910) pp. 447-87 (2 pls. and 8 figs.).

|| La Cellule, xxvi. (1910) pp. 7-24 (1 pl.).

¶ Zool. Jahrb., xxix. (1910) pp. 139-90 (2 pls. and 31 figs.).

** Arch. Biol., xxv. (1910) pp. 1-75 (3 pls.).

†† Anat. Anzeig., xxxv. (1910) pp. 561-87 (7 figs.).

left segment, includes all the derivatives of the intermediary vesicle of this segment. It includes not only the canal of the excretory organ (the "nephridium" of Hatschek *sensu stricto*), but also the portion of the mesodermic segment that is represented in the adult organ by the "chambrettes à solénoocytes." The general thesis is that the nephridium of the buccal metamere and the excretory organs of the branchial metameres are homodynamous.

Hybridisation of Wolf and Dog.*—Paul Paris gives a short account of the evidence in regard to the crossing of wild she-wolf by a domestic dog in 1879 in the department of Côte-d'Or. Two of the young ones showed some of the distinctive characters of the father.

Plumage of Hybrids between Guinea Fowl and Fowl.†—M. F. Guyer finds that the plumage of these hybrids is in some cases atavistic, showing alternate light and dark chevrons, which is characteristic of some types like *Polyplectron* and *Agelastes*, and may have been the primitive plumage of the pheasant family.

Development of Penguin.‡—D. Waterston and A. Campbell Geddes have studied a series of embryos of *Pygoscelis papua* and *P. adeliæ* brought home by the "Scotia" Expedition. They contrast the penguin embryo with that of the duck. "The fore limb of the penguin is, in its mesoblastic structures, definitely progressive, whereas the mesoblastic portion of the duck's wing is relatively regressive." In some notes on the adult birds, attention is directed to the extraordinary convexity of the curve of the neck. The trachea and œsophagus enter the thorax on a plane posterior to the cervical spines. The convexity may be "useful to the birds by increasing water displacement anteriorly, and permitting the head and beak being carried without undue fatigue, and the long ocean voyages which the birds undertake."

b. Histology.

Nuclear Structure.§—H. Stauffacher has studied embryonic liver cells and vegetable cells. The oxychromatic matrix-substance of the nucleolus is continuous by internal nuclear bridges with the oxychromatin of the nucleus, and that with the oxychromatin of the cytoplasm. The basichromatin has always an oxychromatin foundation; in the nucleoli it arises from the oxychromatin; it passes into the nucleus, and thence, as cytomicrosomes, into the cell-substance.

The so-called centrosome consists of basichromatic material. It is not an individualised structure, but a local differentiation of protoplasm. It is passive in cell-division. The division of the nucleus is not preceded by a division of centrosomes. The spindle figure is due to the oxychromatin meshwork of nucleus and cytoplasm.

Relations of Nucleus and Cytoplasm.||—W. Knoll has studied this question in the leucocytes of the blood and bone-marrow. There are

* Bull. Soc. Zool. France, xxxv. (1910) pp. 58-9.

† Bull. Mus. Hist. Nat. Paris, No. 1, 1906, pp. 3-5 (2 figs.).

‡ Trans. Roy. Soc. Edinburgh, xlvii. (1909) pp. 223-44 (3 pls.).

§ Zeitschr. wiss. Zool., xcv. (1910) pp. 1-119 (2 pls. and 3 figs.).

|| Tom. cit., pp. 120-90 (1 pl.).

nuclear bridges connecting contractile portions of the nucleus with contractile portions of the cytoplasm. There is a connection by means of the cytomitom between structural elements of the nucleus and the "centrosomes." The latter are spherical differentiations of the cytoplasm. There are no isolated nuclei in the polymorphic leucocytes. No nuclear membrane was to be seen.

Theory of Cell-division.*—Angel Gallardo regards cell-division as "essentially a bipolar phenomenon of an electro-colloidal character." He assumes a negative electro-colloidal charge for the chromatin and an opposite one for the cytoplasm and centrosomes. He refers to similar suggestions by Ziegler, Hartog, Delage, and others.

Skin of Pleurodeles.†—J. Gogorza has made a study of the minute structure of the skin in this newt, with particular reference to the glands, the nerve-endings, and the chromatophores.

Mucous Epithelium.‡—Ang. Lelièvre and Ed. Retterer find that the mucous cells in the genital duct of the female guinea-pig start from the state of epithelial cells with vesicular nucleus and granular basophilous cytoplasm. The granular cytoplasm elaborates hyaloplasm which is transformed into mucus, while the nucleus is reduced to a block of chromatin. Finally the mucin liquefies; the reticulum and the nucleus are disintegrated. The mucus which lubricates the tract is thus the result of "holocrine" secretion.

Tactile-cells of Grandry's Corpuscles.§—N. Nowin describes the minute structure of these cells in the bill of the duck, with particular reference to the network of fibrils within them. The fibrils stain like those in epithelial cells in the skin; there are intercellular bridges connecting the tactile cells to one another, and the tactile disks are only apposed to, not organically united with, the tactile cells. All this indicates that the tactile cells are epithelial in origin and nature.

Sensory Organs of Onychodactylus.||—K. Okajima gives an elaborate account of the minute structure of the olfactory organ, ear and eye of this Japanese amphibian, both in its adult and larval state.

Granules in Nerve-cells.¶—W. M. Smallwood and C. G. Rogers have studied the metabolic bodies in the cytoplasm of nerve-cells in *Chromodoris zebra* and other Bermudas Gastropods, *Octopus rugosus*, and a leech *Semiscollex*. They find that the presence of granules, either pigmented or unpigmented, is general. An equally constant feature of the cytoplasm is the vacuole. In some cases vacuolation may be a mark of pathological conditions, but it is more generally a sign of previous activity on the part of the cell. The contents of the vacuoles represent granular matter in process of transformation to be used as food-matter by the cell protoplasm. The granules may be caused to break down and

* Archiv Entwickl., xxviii. (1909) pp. 125-56 (9 figs.).

† Mem. R. Soc. Espan. Hist. Nat., vi. (1909) pp. 67-103 (3 pls. and 8 figs.).

‡ C.R. Soc. Biol. Paris, lxxviii. (1910) pp. 596-9.

§ Anat. Anzeig., xxxvi. (1910) pp. 217-25 (5 figs.).

|| Zeitschr. wiss. Zool., xciv. (1909) pp. 171-239 (2 pls. and 6 figs.).

¶ Anat. Anzeig., xxxvi. (1910) pp. 226-32 (3 figs.).

contribute their material under any condition which uses up the ordinary supplies of energy, as for example under excessive work or long-continued starvation.

Internal Reticulum in Ganglion-cells.*—R. Legendre has made numerous experiments, which corroborate his previous conclusion that the fine reticulum described by Golgi inside nerve-cells is due to the chromatophilous substance in the cytoplasm. It may be that it is simply a particular aspect of the kinoplasm, or ergastoplasm, brought out by the silver treatment.

Blood of Amphibians.†—A. Freidsohn finds that the leucocytes with polymorphic nuclei and the medullary leucocytes, and, perhaps, also the pigment-leucocytes, arise from the same type of cell—small spherical cells with a large spherical nucleus and a very narrow basophil plasmic margin. The red blood-corpuscles have a similar origin. These originative cells are like lymphocytes in Mammals, and should be called lymphocytes. They are relatively more numerous in younger and in simpler types. They are ontogenetically and phylogenetically primitive forms of blood-cell.

Glycogen of Muscle.‡—J. Arnold discusses the occurrence of glycogen in the frog's striped muscle. There is none in the fibrils. It is associated with the sarcosomes, which lie longitudinally (corresponding to the inter-columnar spaces) or transversely, and appear as discrete granules or as networks, according to the amount of glycogen. The whole constitution of the muscle-fibre is discussed.

Hyaline Cartilage in Mammals.§—J. Renaut and C. Dubreuil find that the matrix forms, increases, and reaches maturity outside the cytoplasm, around the cells and in the interspaces between their anastomosing prolongations. When the matrix reaches its typical differentiation the prolongations which have helped to form it can no longer live, and mobile cells can no longer penetrate.

Calcification of Selachian Cartilage.||—W. Lubosch discusses the deposition of lime which occurs in the intercellular substance, leaving the cartilage-cells intact. The deposition is not at random, but is related to particular requirements, forming, for instance, in certain joints of *Raja*, what may be compared to epiphyses in Mammals. In both cases there is an adaptation to conditions of special pressure. Other instances are given to illustrate the adaptive character of the calcification.

Minute Structure of Tonsils.¶—G. Illing has made an elaborate study of the tonsils in various Mammals. A true "tonsilla" is characterised by the cytoblastic character and the thickening of the mucous membrane, by the occurrence of secondary lymph-nodules in the cytoblastic tissue, by an increase in the surface of the mucous membrane, and by a more or less distinct definition from adjacent structures.

* Anat. Anzeig., xxxvi. (1910) pp. 207-17 (6 figs.).

† Arch. Mikr. Anat., lxxv. (1910) pp. 435-72 (1 pl.).

‡ Op. cit., lxxiii. (1909) pp. 265-87 (2 pls.).

§ C.R. Soc. Biol. Paris, lxxviii. (1910) pp. 599-601.

|| Anat. Anzeig., xxxv. (1909) pp. 1-8 (8 figs.).

¶ Morphol. Jahrb., xl. (1910) pp. 621-56 (1 pl. and 7 figs.).

Glands in Gall-bladder of Dog.*—G. Cutore † corroborates his previous observation, criticised by Jurisch, ‡ that small multicellular intra-epithelial glands occur on the wall of the gall-bladder in the dog.

Degeneration and Regeneration of Thymus in Modified Nutritive Conditions.§—Arvid Jonson finds that the thymus of the rabbit undergoes rapid and far-reaching involution in conditions of persistent under-feeding, and that it regenerates rapidly when good nutritive conditions are restored. He gives a histological account of both processes.

Origin of Vertebrata.||—E. S. Goodrich holds that no theory as yet brought forward is satisfactory. All violate the sound principles of phylogeny based on the combined evidence of comparative anatomy and physiology, embryology, and palaeontology. "This evidence enables us to trace back the Gnathostomes to a primitive shark-like fish; the Gnathostomes and Cyclostomes to a common form of much more uniformly segmented structure; and finally the Craniata and Cephalochorda to an ancestor of very simple structure, without dermal skeleton and without pronounced cephalisation, which probably became extinct even before the Silurian Age."

Physiology of Senescence.¶—A. Lorrain regards senescence as largely due to changes in the blood-glands, especially the thyroid, which tend to weaken the processes of metabolism, to promote the growth of connective-tissue, and to lessen the activity of the "anti-toxin" ("entgiftende") organs. But it is an incurable disease ("senectus ipsa morbus"), and as inevitable, eventually, as death.

Homologies of Mammalian Pterygoid.**—H. Fuchs has studied the pterygoid, palatine, and parasphenoid in quadrupedal Vertebrates, and the general question of the relation of nerves to skeletal parts. We cannot do more here than refer to one of his general results, that he has given a better basis than previously for the conclusion that the Mammalian pterygoid is homologous with the pterygoid in non-Mammalia, and is not homologous with the parasphenoid.

Ligaments of Oviduct of Domestic Fowl.††—Maynie R. Curtis was led to an anatomical investigation by observing the apparent distribution between the musculature of the wall and the powerful peristalsis that occurs. The purpose of the investigation was to determine whether or not there exists an extrinsic musculature capable of aiding peristalsis. It was found that there is a highly developed musculature in the ligaments of the oviduct, and it was further demonstrated that this is continuous with the musculature which is intrinsic in the walls of the oviduct. The outer muscle layer of the oviduct is continuous with the muscle fibres from the ligaments. This is similar to the condition in Mammals, where the outer longitudinal layer of muscle of the uterus

* Anat. Anzeig., xxxvi. (1910) pp. 100-3 (2 figs.).

† Arch. Anat. Embryol., v. (1906). ‡ Anat., Hefte xxxix. (1909).

§ Arch. Mikr. Anat., lxxiii. (1909) pp. 390-443 (2 pls. and 11 figs.).

|| Rep. British Assoc. for 1909 (1910) p. 484.

¶ Das Altern, seine Ursache und seine Behandlung. Leipzig (1909) 257 pp.

** Anat. Anzeig., xxxvi. (1910) pp. 33-95 (47 figs.).

†† Tom. cit., pp. 472-6 (1 fig.).

develops from the muscle fibres in the broad ligament. The interesting fact is noted that the ovary of a laying hen is practically walled off by peritoneal surfaces from the rest of the abdominal cavity. The discharged ova are by mechanical necessity brought close to the mouth of the oviduct.

Change of Colour in a Ratel.*—F. D. Welch observes that a ratel (*Mellivora ratel*) which has lived in the Zoological Society's Gardens for about twenty years has begun to change markedly in colour—probably through senescence. The large dorsal patch of grey began in 1907 to turn black, and now the whole of the back is black with just a sprinkling of grey hairs.

Immunity of Hedgehog.†—Alex. Strubell finds that the hedgehog (so highly immune to snake poison) is relatively immune to the toxins of diphtheria and tetanus. The question arises whether the hedgehog has separate antitoxins for these various poisons, or whether it lacks appropriate receptors in the essential organs. The resistance of adult hedgehogs to cyanic compounds injected intra-pleurally is as great as, or greater than that of new-born puppies and guinea-pigs, which is much greater than that of the adults. Towards other poisons the hedgehog does not seem more resistant than other animals.

Reptiles and Amphibians of Jamaica.‡—Thomas Barbour makes a preliminary report on the reptiles and amphibians of this island, where great changes have taken place and are still going on. The introduction of the mongoose (*Herpestes griseus*) has caused the almost complete extinction of many species which were once abundant, and has in some ways radically changed the facies of the fauna. Snakes have suffered perhaps more than lizards. None are venomous.

The island has thirty-four species of amphibians and reptiles, of which twenty-five are peculiar. The derivation of these is partly through the Lesser Antillean Chain from north-eastern S. America, and partly from directly west. The nature of the land animals (including snails, earth-worms, *Peripatus*, etc.) shows that fortuitous distribution has played practically no part in providing the Antilles with a fauna. The Greater Antilles must have had continental land-connections westward and south-eastward.

Toxic Action of Mucus of Amphibians.§—Mme. Phisalix finds that the mucus of *Triton cristatus*, *Salamandra maculosa*, and *Alytes obstetricans*, is a true poison, sometimes as toxic as the secretion of the dorsal poison-glands. It has the same influence on all the animals experimented with (amphibians, reptiles, birds, and mammals), stupefying, paralyzing, and stopping the heart. A frog is killed by an injection of its own mucus.

Nesting Habits of *Phyllomedusa sauvagii*.||—W. E. Agar describes the remarkable nesting habits of this tree-frog from the Paraguayan

* Proc. Zool. Soc. London, pt. 4 (1910), pp. 889-91.

† Centralbl. Bakt. Parasitenk., liii. (1909) pp. 43-60.

‡ Bull. Mus. Comp. Zool., lii. (1910) pp. 273-301 (2 pls.).

§ Comptes Rendus, cl. (1910) pp. 415-18.

|| Proc. Zool. Soc., 1909, pt. 4 (1910) pp. 893-7 (1 pl.).

Chaco. The nest is suspended from bushes overhanging a pool into which the tadpoles drop when they are hatched. The lower ends of a number of leaves are drawn together by a deposit of empty egg-capsules. The nest is filled with a mixture, and there is a plug of empty cases at the top. The empty cases serve as shields from sun and air, and they provide an extra source of fluid; the plug at the bottom keeps the nest intact till the larvæ are ready to fall out. In the less perfect nests the mortality is greater.

Abnormalities in Frog's Circulation.*—Chas. H. O'Donoghue describes three cases in which there was a persistence of the posterior cardinal vein or veins, and an absence of all but the inter-renal segment of the post-caval. He notes a number of abnormalities in the renal portals, and comments on the fact that eight out of nine specimens were males. Woodland's theory of the non-portal nature of the kidney in the frog is adversely criticised. Evidence from abnormalities and experiments seems to show clearly that the kidney has a true portal circulation.

Kidney of Teleosteans.†—J. Audigé has made a detailed study of the macroscopic and microscopic structure of the kidney in numerous Teleostean types, such as *Barbus fluviatilis*, *Lophius*, *Anguilla*, *Ophidium*, *Perca*, *Gasterosteus*. He distinguishes three regions—anterior, abdominal, and terminal—which differ distinctly, though by no means brusquely, in their degree of differentiation. Embryologically, however, the various parts are synchronous—the kidney of Teleosteans is a mononephros.

Caudal Fin of Elopidae and some other Teleosteans.‡—C. Tate Regan points out that the homocercal fin should be defined not by the presence of a urostyle formed by the fusion of up-turned vertebrae, but by the modification of posterior neural arches into "uroneurals," which functionally replace and so lead to the suppression of the centra of the upturned vertebrae.

Tensor Muscle of Choroid in Teleosteans.§—E. Grynfeldt finds that what has hitherto been regarded as a ciliary ligament in the anterior segment of the eye in Teleosteans, superficially in the middle tunic, is a muscle for which he proposes the name "tensor of the choroid."

Segmental Structure of Motor Nerve Plexus in Elasmobranchs.|| E. S. Goodrich modifies to some extent his conclusion that the four radial muscles of a segment are supplied only by the one spinal nerve belonging to the myotome from which they arose. Mollier and Braus are right in thinking that the adult radial muscles are to some extent mixed, and that the bridges connecting the base of the muscle buds at a certain stage in their development really represent a migration of muscle-forming substance from one segment to another. But the mixing in *Raja* is very slight.

* Anat. Anzeig., xxxvi. (1910) pp. 355-69 (5 figs.).

† Arch. Zool. Expér., iv. (1910) pp. 275-624 (1 pl. and 104 figs.).

‡ Ann. Nat. Hist., v. (1910) p. 354-8 (2 figs.).

§ Comptes Rendus, cl. (1910) pp. 420-1.

|| Anat. Anzeig., xxxvi. (1910) pp. 109-12.

Fauna of Forth Area.*—William Evans has done a useful piece of work in making a report of what is at present known of the fauna of the Forth area, 6865 species in all, of which the author has met with about 4250 in the course of his investigations.

Fresh-water Microfauna of German East Africa.†—E. von Daday reports on a large miscellaneous collection. Among the Protozoa there are species of *Arcella*, *Distuglia*, *Euglypha*, *Actinosphærium*, *Raphidiophrys*, *Peridinium*, *Ceratium*, *Volvox*, *Trachelomonas*, *Euglena*, *Trachelius*, *Uronychia* (1 new), *Cothurnia*, *Vorticella*, *Acineta* (2 new), *Solenophyra* (1 new). He also reports *Hydra fusca*, 2 new Cercariae, 2 new Cestode larvæ, several new species of Nematodes (*Trilobus*, *Mononchus*, *Plectus*, *Cephalobus*, *Dorylaimus*), a new larval *Echino-rhynchus*, and some Gastrotricha.

Microscopic Fauna at Cape Royds.‡—James Murray directs attention to the abundant microscopic fauna at Cape Royds (77° 30' S.), where there is no vegetation higher than mosses, and very few of these. The kinds of animals which are usually to be found among mosses have at Cape Royds a shelter of another sort, the foliaceous vegetation in the lakes and ponds. On the surface and between the layers of this they abound both summer and winter. In summer, when the ponds are melted, they enjoy for some weeks a warm climate, the temperature rising as high as 60° F. in some ponds. There they are sheltered from the air, which would freeze them every day if they lived among the mosses. In winter again they are frozen in the ice for many months, in some of the deeper lakes for many years.

Most abundant are the Rotifers (16 species), dominant among which are *Philodina gregaria* sp. n., and *Adineta grandis* sp. n., both viviparous. The water-bears are only of a few kinds, but one of them (*Macrobotus antarcticus*) is extremely abundant. There are Nematode worms of two or more kinds, mites of several kinds, and two Entomostracan Crustacea. The Ciliate Infusorians were very numerous, and there were a good many Flagellates. Only two Rhizopods were found.

Tunicata.

Study of a Tunicate.§—W. E. Ritter has made "a comprehensive inquiry as to the extent of law and order that prevails in a single-animal species." His subject was *Halocynthia johnsoni* sp. n. He directs special attention to the "manifolding of similar parts"—some arising (like the branchial stigmata) as lineally genetic series, others (like the tentacles) arising as repeated productions from common original substrata. Many of the repetitive series "are subject to definite schemes as to positional arrangement and time of origin, and also as to mass relations." A Puget Sound "species," *H. haustor*, is compared with the Californian *H. johnsoni*, but "the attempt to find a causal relation, or a necessary correlation, between the character differentials of the two species and their environmental differentials has produced negative results."

* Proc. Roy. Phys. Soc. Edinburgh, xvii. (1909) pp 1-64.

† Zoologica, xxiii. Heft. 59 (1910) pp. 1-56 (4 pls.).

‡ Rep. British Antarctic Exped., 1907-9 (Biology) i. (1910) pp. 1-79 (13 pls. and 3 figs.).

§ Univ. California Publications (Zool.) vi. (1909) pp. 65-114 (8 pls.).

INVERTEBRATA.

Mollusca.

Ecological Study of Molluscs.*—F. C. Baker has made an ecological study of the Stokie Marsh Area, near Chicago, with particular reference to the Molluscs. In illustration of the value of this kind of study, it is pointed out that *Physa gyrina* and *P. oledcea* were always associated, a fact which led to a recognition of the latter species as a half-grown stage of the former. In the same way it was found that *Lymnæa palustris michiganensis* Walker, *L. reflexa crystalensis* Baker, and *L. reflexa* Say, are three stages of one form. The author deals with thirty-eight species and varieties found in the area, which is 3 miles long and half a mile broad.

α. Cephalopoda.

Young Spirula.†—L. Joubin describes the first young *Spirula* that has been seen. It was captured from 3000 m. south-east of the Canaries by the Prince of Monaco. It was about 5 mm. long. The shell had six chambers, forming almost a whorl. It was completely covered by the mantle. The lateral diverticula of the visceral cavity, which lie on each side of the shell in the adult, were not developed. There is no hint of the median posterior sucker. The eyes do not show any of the telescopic character seen in the adult.

Dibranchiate Cephalopods of Coasts of Ireland.‡—Anne L. Massy deals with twenty-seven species, eight of which are now recorded for the first time in British waters. To the family Cranchiidae an interesting new form is added, *Helicocranchia pfefferi*. The new genus is thus defined:—Body elongated, chalice-shaped, tapering gradually to a rounded point. Mantle substance tough, smooth, pale, with many small chromatophores. Fins considerable, oval, pedunculate, attached to end of the dorsal surface of the body. Eyes on short stalks, large, in the form of a low cone. Arms long, with keel and lateral membrane moderately developed. Tentacles long and expanded into a club. Siphon extremely large.

Salivary Juice of Cephalopods.§—Etienne de Rouville has experimented with the extract of the glands of the common *Eledone moschata*. The extract of the posterior salivary glands is markedly toxic for the rabbit; the extract of the anterior glands is less active, but also toxic (crabs and rabbits). The poison acts on the central nervous system of the crab. In the rabbit it acts on the respiratory and vascular centres: it dilates the vessels, and the blood remains liquid.

β. Gastropoda.

Early Stage of Acmæa.||—Edward S. Morse finds that in the nucleus of very young specimens of *Acmæa testudinalis*, less than half a millimetre in length, there is no suggestion of a coiled "nautiloid" shell.

* Bull. Illinois Stat. Lab. Nat. Hist., viii. (1910) pp. 441-99 (20 pls.).

† Comptes Rendus, cl. (1910) pp. 414-15.

‡ Scient. Invest. Fisheries Ireland, No. 1 (1909) pp. 1-39 (3 pls.).

§ Bull. Acad. Sci. Montpellier, No. 5 (1910) pp. 125-47 (2 figs.).

|| Proc. Boston Soc. Nat. Hist., xxxiv. (1910) pp. 313-23 (8 figs.).

"It was simply a caecal-like shell with slight dorsal flexure, and minutely granulated without lines of growth." This primitive condition of the embryo shell "is certainly a low character, and is correlated with many low characters of the order." In early Cambrian forms a very close resemblance is seen to the very early shell-stage in the modern *Acmeæa*.

Arthropoda.

Guide to Crustacea, Arachnida, Onychophora, and Myriopoda of the British Museum.*—W. T. Calman deals with the Crustacea, A. S. Hirst with the Arachnids and Myriopods, F. Jeffrey Bell with the Onychophora and Pentastomida, in this lucid guide to the British Museum collections.

a. Insecta.

Ants and Plants.†—K. Escherich discusses critically the interrelations of ants and plants. Ants wound the buds of foliage trees; they help the green flies (notably the root-aphides; they cut off leaves; they do harm with their nests; they drive off other insects from the floral nectaries; they sometimes destroy flowers; and so on. In the case of *Camponotus ligniperdus* the tunnels weaken the tree, and *Crematogaster scutellaris* injures the bark of the cork-oak. On the other hand, they have a protective value, and they distribute certain seeds.

Cave Beetles.‡—R. Jeannel proposes a new classification of the cavernicolous Silphidae, for he finds that the tribe Bathysciæ is apparently polyphyletic, and that the genus *Bathyscia* Schiödte must be broken up. He proceeds to do this, establishing four groups—Euryscapiti, Gynomorphi, Brachyscapiti, Antroherpona—and leaving a number of uncertain species.

Larvæ of *Megatoma undata*.§—A. Popovici-Bazosann describes the moult in these larvæ, which devour the contents of the cells in the nests of various wild bees. The cuticle is most delicate along the dorso-median line, and in moulting the split occurs along this line of least resistance. The number of moults is not always in relation to the growth of the larva. It may moult several times when it is not feeding or growing. The change of setæ on the surface seems to be a condition of ecdysis.

New Tipulidæ.||—Charles W. Johnson describes a number of new or little known North American Tipulids, including *Aeschnasoma river-tonensis* g. et sp. n., an interesting form with antennæ like those of *Longurio*, but with a venation and genitalia that will not permit of its being placed in that genus nor in *Tipula*.

Structure of Nucleus in Cells of Salivary Glands of *Chironomus* Larvæ.¶—M. A. van Herwerden gives a fresh account of the structure

* Guide to the Crustacea, Arachnida, Onychophora, and Myriopoda exhibited in the Department of Zoology, British Museum (Natural History) (1910) 133 pp. (90 figs.).

† Tharandt. Forstl. Jahrb., ix. (1909) pp. 66-96 (2 figs.).

‡ Arch. Zool. Expér., v. (1910) pp. 1-48 (23 figs.).

§ C. R. Soc. Biol. Paris, lxxviii. (1910) pp. 628-30 (1 fig.).

¶ Proc. Boston Soc. Nat. Hist., xxxiv. (1909) pp. 115-33 (2 pls.).

¶ Anat. Anzeig., xxxvi. (1910) pp. 193-207 (1 pl.).

of this much-studied nucleus, and emphasizes the fact that the chromatin-thread forms a spiral closely coiled on itself. This structure, described by some as cross-striation, seems to be permanent in *Chironomus*, and the author believes that this is no unique case.

Flies and Typhus Fever.*—E. Bertarelli submits experimental evidence showing that house-flies may serve as disseminators of typhus fever.

Head and Mouth-parts of Dipterous Larvæ.†—R. Becker has made a welcome contribution to our knowledge of the mouth-parts of dipterous larvæ. He deals with *Encephala* (*Chironomus*, *Simulia*, *Sciara*), *Polyneura* (*Tipula*, *Pedicia*), *Orthorrhapha brachycera* (*Atherix*, *Stratiomys*), and *Cyclorrhapha* (*Musca*, *Anthomyia*). The interpretation of the reduced head of a Muscid larva is briefly discussed.

Adaptations of Parasitic Diptera.‡—J. Pantel discusses the manner of exploiting the host in Sarcophagidæ, Conopidæ, Tachiinidæ. He describes parasitism in ganglia and in muscles, and various reactions on the part of the host. Castration by parasites is discussed, and the struggle of parasite with parasite. The author compares different life-cycles in the families studied. The influence of the host on the parasite is also discussed. But we cannot do more than indicate the general scope of this investigation.

Structure, Habits and Life-history of Candle Fly.§—J. C. W. Ker-shaw gives an account of *Pyrops candelaria*, and G. W. Kirkaldy furnishes some additional notes. The snout is not luminous, as has been sometimes asserted, but the food-reservoir extends to the tip of it. The male is a long time courting the female, and is jealous of another's attentions. All day long he stretches out and vibrates the hind leg on the side nearest the female and sways his body from side to side. They appear to couple only at night. The eggs are laid in straight rows on a trunk or branch, thinly covered with colleterial fluid, and brushed over with white waxy matter. They hatch in about twenty-six days, and the nymphs can run and jump soon after their emergence. They sit in long and fairly ordered rows, very cryptic in form and colour. When nearing their fifth moult they have a slight secretion of wax on the abdomen. The wax of *Pyrops* is formed in bundles or masses of thread or fibres; it collects largely over the spiracles and in the wax-pockets; more than one kind of parasite, or rather, perhaps, inquiline, lives in it and feeds on it, e.g. a minute mite, not so large as this full-stop. An interesting account is given of the internal structure, particularly of the alimentary system.

Post-antennary Organ of Collembola.||—E. Becker gives an account of the structure of this organ in Poduridæ, Entomobryidæ, and Sminthuridæ. In all cases the sensory cells of the organ are internal to the epidermis, and they are innervated from the protocerebrum, and, except

* Centralbl. Bakt. Parasitenk., liii. (1910) pp. 486-95.

† Zool. Jahrb., xxix. (1910) pp. 281-314 (3 pls. and 5 figs.).

‡ La Cellule, xxvi. (1910) pp. 27-216 (5 pls. and 26 figs.).

§ Zool. Jahrb., xxix. (1910) pp. 105-24 (3 pls.).

|| Zeitschr. wiss. Zool. xciv. (1910) pp. 327-99 (2 pls.).

in *Orchesella* and *Tomoceros*, from the lateral lobes of the protocerebrum. They have other features in common, and are probably homologous throughout the Collembola. The author inquires into their phylogenetic significance. He discusses also the physiological significance of the organ, and finds anatomical reasons sufficient for regarding it as auditory.

δ. Arachnida.

Functions of Lymphatic Gland of Scorpion.*—Max Kollmann has studied this gland in *Buthus occitanus*, where it consists of a series of masses attached along the nerve-chain in the cephalothoracic and præ-abdominal region. Each mass is penetrated by ramifications of the sub-neural lacuna, which divide it into nodules separated by irregular spaces filled with blood.

This "gland of Blanchard" is a lymphogenic organ. It is not phagocytic. It has a structure exactly like that of the lymphogenic organs of Crustaceans, but its function is intermittent.

Catalogue of Nearctic Spiders.†—Nathan Banks has prepared a catalogue of North American spiders, including over 1300 species. He says that there will be certainly 2000 when the West and South are explored as thoroughly as New England now is. The largest family is the Theridiidæ with 208 species; the Attidæ come next; two other families, the Lycosidæ and Epeiridæ, have over 100 species in each.

Behaviour of Spiders.‡—Thos. H. Montgomery, jun., describes some of the peculiar ways of spiders. In *Phidippus*, *Drassus*, etc., the process of "sperm-induction" was watched. A special sperm-bridge is spun, a droplet of sperm is placed upon it on the side next the spider's body, then the palpi are applied alternately against the opposite side and charged. In *Ariadna* the mouth (or salivary secretion) is used to agglutinate the eggs, which is unique. In *Ariadna*, like *Dysdera*, there is no special cocoon for the eggs, though both build nests. Experiments show that young Lycosids are unable to bite their own way out of the cocoon; the mothers bite it open along the line of the junction of base and cover. There seems to be stridulation in the genus *Geotrecha*, but this may appeal to touch, not hearing. There is no proof that spiders can hear. The process of copulation is described in a number of types.

Spiders of Spain.§—E. Fernandez Galiano gives a list of the known species of spiders in Spain, with notes on their local distribution.

New Gall-mite on Hawthorn.||—J. Cotte describes *Eriophyes cratægumpticans*, which makes galls on the upper surface of leaves of *Cratægus oxyacanthoides*. The galls have no hairs. In the case of *Eriophyes goniothorax*, which seems scarcely able to live except on the leaves of *Cratægus monogyna*, the margins of the leaves are rolled up, and there is abnormal development of hairs. Here we have to recognize physiological specific characters.

* Bull. Soc. Zool. France, xxxv. (1910) pp. 25-30.

† U.S. Nat. Museum, Bull. 72, 1910, pp. 1-80.

‡ Proc. Acad. Nat. Sci. Philadelphia, 1909, pp. 548-69.

§ Mem. R. Soc. Espan. Hist. Nat. vi. (1910) pp. 343-424.

|| C.R. Soc. Biol. Paris, lxxviii. (1910) pp. 643-6.

Mites in Man.*—Tièche reports that mites belonging to the family Tyroglyphidæ occurred in multitudes in the stools of three patients suffering from prurigo. Though it is not likely that the mites had anything to do with the prurigo, their occurrence as temporary endoparasites seems certain.

Mites in Tumours.†—Fr. Dahl describes *Tarsonemus hominis* sp. n. found by Saul in a fibroma and carcinoma of the human ovary—a very interesting discovery. He discusses the important question whether this new mite was simply a parasite in the tumours, or was part of the cause of them. It is well known that some of the species of *Tarsonemus* cause cell-proliferation in plants.

e. Crustacea.

Habits of Robber Crabs.‡—C. W. Andrews describes the habits of *Birgus latro* on Christmas Island, and publishes an interesting photograph showing them climbing trees. In so doing they cling by the sharp points of the walking legs, hardly using the great claws at all. They feed on fruits of various kinds—e.g. of sago-palm and screw-pines, and on carrion. They steal almost anything portable that has been handled. Though probably nocturnal in most cases, they moved about in the forest on Christmas Island in the brightest daylight. They are easily frightened, and scuttle backwards, propelling themselves with their long anterior legs in a series of ungainly jerks. They thrust their abdomen under logs, or into holes among the roots of trees, but they never carry any protective covering.

Cenobita and Acquired Characters.§—E. Bagnion describes the exquisite adaptations of *Cenobita rugosa*, common on the Ceylon coast, to its life within a Gastropod shell. But the creature was once a free-swimming zoëa. What is the significance of its asymmetrisation, reduction, and detailed adaptation? According to the author, "the asymmetry of the appendages, so marked in this species, should be regarded as a character acquired in the course of phylogenetic evolution, as the result of adaptation to a special mode of life."

Bagnion would distinguish various grades of "modifications"—that is to say, structural changes brought about in the individual life-time as the direct result of changes in function or in environment. (1) Those that are useless or harmful are not inherited, like those of circumcision and of curtailing fox-terriers. But these do not seem to us to conform to the definition of modifications. (2) Other changes, developing slowly, and saturating more deeply, have a tendency to be inherited, such as hare-lip, syndactylism, polydactylism, ankylosis, and muscular atrophy. Many of these, we submit, are obviously not modifications, but expressions of germinal variations. (3) Lastly, there are modifications acquired in the course of the individual lifetime in response to new conditions, and they tend to be inherited, as in the case of *Cenobita*. But no evidence is given in support of this conclusion.

* Centralbl. Bakt. Parasitenk., liv. (1910) pp. 32-6 (2 figs.).

† Op. cit., liii. (1910) pp. 524-33 (2 figs.).

‡ Proc. Zool. Soc., 1909, pt. iv. (1910) pp. 887-9 (1 pl.).

§ C.R. Soc. Biol. Paris, lxxviii. (1910) pp. 799-800.

Habits of Hermit Crabs.*—Anna Drzewina has studied *Clibanarius misanthropus*, and finds that those at Banyuls-sur-Mer (Mediterranean) show a constant positive phototropism, while those at Arcachon (Atlantic) show a phototropism which changes periodically from positive to negative and back again. There seems to be some connection between this difference of reaction and the absence and presence of tides. It is shown that various factors—chemical, physical, and mechanical—may affect the “sign” of the phototropism. It is also possible to create experimentally in the hermit-crabs new psychical associations, for they learn to distinguish shells of different forms.

Paramola cuvieri in Scottish Waters.†—James Ritchie records the capture of a good specimen of this rare crab from between the Flannan Islands and the Butt of Lewis. This widens considerably the northern boundary of the tract within which this distinctly southern form is known to live.

Decapoda from North Side of Bay of Biscay.‡—Stanley Kemp reports on a collection of forty-nine species made by the ‘Huxley.’ The majority are well-known members of the north-east Atlantic fauna. Five species not hitherto known to extend south of the British Isles are recorded. A fragment, which has been tentatively referred to *Periclimenes korni* (Lo Bianco) is of much interest, for no deep-water representative of the family Palæmonidæ was hitherto known from the north-east Atlantic.

Upogebia stellata and Gebia deltura.§—W. de Morgan discusses the question whether these are distinct species, or merely sexual forms of one species. He has examined a good many examples of both forms, which occur together at Salcombe, and concludes that they are quite distinct.

Japanese Stomatopods.||—T. Fukuda reports on a collection of fourteen species, of which two are new—*Gonodactylus spinosocarinatus* and *Lysiosquilla crassispinosa*.

Revision of Monolistrini.¶—E. G. Racovitza continues his study of cavernicolous animals, discussing those which belong to the Isopod sub-family Sphæromiæ. He gives a careful revision of the Monolistrini—*Monolistra* Gerstaecker, *Cæcosphæroma* Dollfus, and various sub-genera.

Alimentary Tract of Lynceus.**—J. Tollinger describes the remarkable type of alimentary canal that occurs in Lynceids, e.g. *Lynceus intermedius*. The fore-gut is very short, so is the hind-gut. The mesenteron is long and coiled, and gives off a ventral, worm-like cæcum extending forwards. Full details are given of the minute structure of all the parts.

* Arch. Zool. Expér., v. (1910) Notes et Revue, No. 2, pp. xliii-lv (2 figs.).

† Ann. Scot. Nat. Hist. (Jan. 1910) pp. 12-14 (1 fig.).

‡ Journ. Marine Biol. Assoc., viii. (1910) pp. 407-20.

§ Tom. cit., pp. 475-7 (2 figs.).

|| Annot. Zool. Japon, vii. (1910) pp. 139-52 (1 pl.).

¶ Arch. Zool. Expér., iv. (1910) pp. 625-758 (14 pls.).

** Ann. Biol. Lacustre, iii. (1909) pp. 271-99 (2 pls.).

Antarctic Isopods.*—T. V. Hodgson reports on a collection of twenty-five species, some of which are new and interesting. Seven, mostly assigned to new genera, have their eyes on enormous peduncles, an entirely new feature among "sessile-eyed" Crustacea. Attention is directed to the sexual dimorphism in Arcturidæ. The male and female of one species, *Antarcturus franklini*, appear on one of the plates as two species—quite markedly different. It was only when all the specimens of both sexes (or, as it was thought, both species) came to be overhauled that the error was noticed. Hodgson shows that *Serolis cornutus* Studer is merely the immature form of *S. trilobitooides* Eights. He expresses his conviction that a very large proportion of the species of the South Polar fauna have a circumpolar distribution.

Twin Sacculina.†—M. Kollman describes a case of a twin *Sacculina betencouri* on *Portunus variegatus*. There were two bodies, but one root-system, and the internal state of the visceral masses pointed to a single origin. The author speaks of this as polyembryony.

New Ascidicolous Copepods.‡—E. Chatton and E. Brément describe the females of *Aplostoma magellanica* sp. n., from a Magellan Synascidian, *A. sacculus* sp. n., from *Diplosoma spongiforme* Giard, and *Aplostoma hibernica* (T. and A. Scott). They show that the generic diagnosis, based on *A. brevicauda*, will have to be enlarged. The characters that are most diverse are those which are most directly in relation with the animal's mode of life (e.g. external form and structure of appendages). Other characters, such as the ornamentation of the vulva, or the nature of the apical plate, are very uniform.

Annulata.

Giant Nerve-cells and Fibres of Halla.§—J. H. Ashworth gives a detailed account of the giant cells which appear in segmental couples in each of the anterior ganglia of this Polychæte, and of the giant fibres, each of which, after leaving the giant-cell from which it arises, crosses the cord to the opposite side and then turns gradually towards the middle line of the cord and runs posteriorly. The contents of the giant-fibre are the equivalent of the axis cylinder of an ordinary nerve-fibre, being a direct continuation of the protoplasm of the giant-cell; moreover, the structure of the axis cylinder of the giant-fibre is very similar to that of the axis cylinder of a medullated nerve-fibre, except that in the former there is nothing comparable to the Ranvier's nodes of the latter. The author gives a detailed description and beautiful figures of the minute structure of cells and fibres, and compares those in *Halla* with those of *Aglaurides fulgida*. A posterior set of giant-cells and fibres has not been dealt with.

Polychæts from the Atlantic adjacent to Ireland.||—R. Southern defines two new species of *Travisiopsis*, and records a number of Alciopinæ, Tomopteridæ, and Typhloscolecidæ.

* National Antarctic Exped. (Nat. Hist.) v. (1910) Crustacea, No. ix. pp. 1-77 (10 pls.).

† Arch. Zool. Expér., v. (1910) Notes et Revue, No. 2, pp. xxxvii-xl (1 fig.).

‡ Bull. Soc. Zool. France, xxxv. (1910) pp. 80-92 (5 figs.).

§ Phil. Trans., Series B, cc., pp. 427-521 (6 pls.).

|| Ann. Nat. Hist., v. (1910) pp. 428-9.

Australian Hirudinea.*—E. J. Goddard continues his studies on Australian leeches, describing *Pontobdella macrothela* Schmarda, *P. australiensis* sp. n., and *Geobdella tristriata* sp. n.

Japanese Leeches.†—Asajiro Oka gives a synopsis of Japanese Hirudinea, and describes 14 new species and 3 new varieties. Unlike most describers of leeches, he does not in this synopsis lay emphasis on the limits of somites. He gives prominence to more readily verified characters. He establishes a new genus *Carcinobdella* for two marine species usually found on crabs.

Nematohelminthes.

Species of Tylenchus in Moss.‡—Paul Horn reports finding *Tylenchus darainii* Bast. among the leaves and root-hairs of a moss (*Brachythecium rutabulum*), and notes that *Tylenchus askenasyi* Bütschli is the same. Similarly Ritzema Bos noted that the free-living *T. intermedius* de Man is the same as *T. devastatrix* (Kühn), parasitic in plants. The author supports the view that many species are the same, but slightly modified by special conditions of life.

Nematodes of the Eye.§—A. Railliet and A. Henry have studied Gurlt's types of *Filaria lacrymalis* from the horse and from the cow. Those from the former correspond with the authors' *Thelazia lacrymalis* (Gurlt), those from the latter correspond to *T. gulosa* Railliet and Henry. The authors give more details of *T. leesei* from the camel, and they describe *T. callipæda* sp. n. from the eye of a dog in the Punjab.

New Species of Atractis.||—O. von Linstow describes *Atractis perarmata* sp. n. from the intestine of *Cinixys belliana*, a tortoise from East Africa. The species of *Atractis* are viviparous, but the offspring remain in the gut, generation succeeding generation till the gut is full, as is often seen in the case of *A. dactylura* in the Greek tortoise.

Adaptation of Nematodes to Temperature of their Hosts.¶—L. Jammes and A. Martin continue their study of the optimum temperature for development. Some Nematodes, such as *Ascaris vitulorum*, *A. suis*, and *Heterakis columbæ*, have eggs which cannot develop except at a temperature lower than that of the host. Many, such as *Ascaris equorum*, *A. canis*, *Oxyuris vermicularis*, *Syngamus trachealis*, have eggs that develop at the temperature of the host or at a lower temperature. A third set, like *Trichina* and *Filaria*, have eggs that develop normally at the temperature of the host. "The necessity for a relatively low temperature, an indifference to gradual increase of the temperature, subordination to the temperature of the host, the viviparous state—these are successive phases of the slow evolution by which the parasite becomes adapted to the high temperature of the higher animals."

* Proc. Linn. Soc. N.S.W., xxxiv. (1910) pp. 721-82 (3 pls.).

† Annot. Zool. Japon, vii. (1910) pp. 165-83.

‡ Arch. Ver. Freunde Naturgesch. Mecklenburg, lxiii. (1909) pp. 67-77 (1 pl.).

§ C.R. Soc. Biol. Paris, lxxviii. (1910) pp. 783-5.

|| Centralbl. Bakt. Parasitenk., liii. (1910) pp. 516-18 (2 figs.).

¶ Comptes Rendus, cl. (1910) pp. 418-19.

Platyhelminthes.

Detection of Echinococcus Disease.*—J. Putzu shows that in the serum of patients suffering from *Echinococcus* there are specific "antibodies," which may be demonstrated by the phenomenon of "complement-formation" in the presence of their specific "antigen," such as the hydatid fluid from the sheep.

New Tetracotyle from Brain of Minnow.†—Franz Mataré gives a full description of the minute structure of a larval *Tetracotyle* found in the brain and skull-cavity of *Phoxinus lævis*.

Bucephalus.‡—D. Th. Ssinitzin finds that the head organ of *Bucephalus* is the modified anterior sucker. In *Gasterostomum* it re-assumes the character of a sucker. A comparison with *Cercaria ocellata* shows that the head-organ is morphologically the oral sucker, buccal cavity, and perhaps pharynx of Distomids. The other parts of the gut are represented in the embryo *Bucephalus* by a series of spaces among the parenchyma-cells. These afterwards disappear.

The alimentary canal of *Bucephalus* and *Gasterostomum* (including pharynx, œsophagus and intestine) corresponds to modified parts of the ventral sucker of Distomids. The primary gut, corresponding to that of Distomids, has degenerated in *Gasterostomum*.

It may be said that *Bucephalus* represents a somewhat modified Distomid Cercaria, that *Cercaria ocellata* represents one of the intermediate stages in the evolution of Gasterostomidæ.

New Trematode from Frog.§—L. Blaizot describes *Cephalogonimus europæus* sp. n. from the intestine of *Rana esculenta*. He contrasts it with the recently discovered *C. americanus* Stafford, and the genus *Cephalogonimus* with the genus *Prymnoprion*.

Distomid Cyst in Blood-vessels of an Oligochæt.||—Al. Mrázek reports the occurrence of a Distomid cyst in the ventral blood-vessel of *Rhynchelmis*, and points out that this and similar cases must be regarded simply as instances of these hardy creatures going astray in unsuitable hosts.

Life-history of Schistosomum japonicum.¶—F. Katsurada and T. Hashegawa have proved experimentally that the young of this worm can pass in a short time from the water of the rice-fields through the skin of cat and dog (as well as of man), and may become sexually mature in the course of a month. It is probable that the miracidium forms a sporocyst from which numerous young worms emerge.

Structure of Polychærus caudatus.**—Leopold Löhner has made a study of this North American littoral Turbellarian, first described by Mark. It belongs to the Convolutidæ, and is characterised by the germo-vitellaria, the numerous (up to 50) chitinous pieces at the mouth

* Centralbl. Bakt. Parasitenk., liv. (1910) pp. 77-91.

† Zeitschr. wiss. Zool., xciv. (1910) pp. 488-540 (1 pl. and 3 figs.).

‡ Tom. cit., pp. 299-325 (2 pls.).

§ Bull. Soc. Zool. France, xxxv. (1910) pp. 34-8 (1 fig.).

|| Centralbl. Bakt. Parasitenk., liii. (1910) pp. 522-4 (1 fig.).

¶ Tom. cit., pp. 519-22 (1 fig.).

** Zeitschr. wiss. Zool., xc. (1910) pp. 451-506 (3 pls.).

of the bursa, the absence of frontal glands. The mouth is ventral, almost in the middle of the body; there is a short simple pharynx; the follicular testes are disposed in two lateral areas; the posterior end is prolonged into two caudal lobes, with up to five retractile caudal filaments, or with none. The author fills up some gaps in previous descriptions, particularly as regards the genital organs.

Fresh-water Nemerteans.*—Paul Hallez discusses the names to be given to these. They have been referred to six genera, but, with the possible exception of the enigmatical *Nemertes polyhopla* found in Lake Nicaragua by Schmarda (1859), all belong to the genus *Prostoma* Dugès. Only a few species are well established; perhaps indeed there are only two, *Prostoma lumbricoideum* Dugès and *P. clepsinoides* Dugès. The species *P. græcense* Böhmig, *P. cùhardi* Montgomery, and *P. clepsinoides* are very closely related if not identical, and *Emea lacustris* Du Plessis is the same as *P. lumbricoideum*.

Antarctic Nemerteans.†—L. Joubin deals with *Lineus corrugatus*, *L. hanseni* sp. n., *Eupolia pumetti* sp. n., *Amphiporus multihastatus* sp. n., and *Telrastemma unilineatum* sp. n., and gives a list of the known Antarctic forms.

Incertæ Sedis.

Hæmocœle in Dinophilus.‡—P. de Beauchamp describes a hæmocoelic system of vascular cavities in *Dinophilus conklini*, which appear to have escaped the attention of previous observers. He points out that they tend to separate this interesting type from the Rotifers, and to bring it near Annelids. He regards *Dinophilus* as a retrogressive Annelid type.

Polyzoon on Pontobdella.§—E. J. Goddard found on *Pontobdella australiensis* what he regards as the stalks of an Entoproctous Polyzoon, like *Lozosoma*. They were previously noted by Macdonald, but misinterpreted as spermatophores.

Cretaceous Bryozoa.||—J. W. Gregory has continued the catalogue of the cretaceous Bryozoa in the British Museum, the present (second) volume dealing with some Cyclostomata, the few Trepostomata, and the single known extinct species of Phylactolamata—viz. *Plumatellites proliferus* Frič. The Cheilostomata are still to be catalogued.

New Catenata.¶—V. Dogiel describes some new forms of very simple Metazoa—*Haplozoon delicatulum* sp. n. from the intestine of one of the Maldanidæ, *H. ariciæ* sp. n. from the intestine of *Aricia norvegica*, *H. macrostylum* sp. n. from another Maldanid, *H. obscurum* sp. n. from *Terebellides strömii*. In the last named, intercellular bridges are very clearly seen. The author also discusses *Siedleckia*, which he regards as

* Bull. Soc. Zool. France, xxxv. (1910) pp. 62-74.

† National Antarctic Exped. (Nat. Hist.) v. Nemertea, pp. 1-15 (1 pl. and 16 figs.).

‡ Bull. Soc. Zool. France, xxxv. (1910) pp. 18-25 (2 figs.).

§ Proc. Linn. Soc. N.S.W., xxxiv. (1910) pp. 725-8.

|| Catalogue of the Fossil Bryozoa: The Cretaceous Bryozoa, ii. (1909) xlviii. and 346 pp. (9 pls. and 75 figs.).

¶ Zeitschr. wiss. Zool., xciv. (1910) pp. 400-46 (2 pls. and 6 figs.).

a multinucleate Gregarine, not as related to *Haplozoon*. A description is given of the ectoparasitic Peridiniid *Gymnodinium pulvisculus*, which, along with *Apodinium mycetoides* Chatton he regards as leading on to endoparasitic *Haplozoon*. According to the author, *Haplozoon* is best referred to a somewhat vague group of Mesozoa along with the Dicyemids and Orthocetids.

Rotifera.

Antarctic Rotifera.*—Amongst the results of Sir E. H. Shackleton's recent Antarctic expedition, not the least interesting is the discovery of an extensive micro-fauna, mostly Rotifera and Tardigrada, living in the pools and small lakes which exist on Ross Island during the short summer season, but which are frozen solid for about ten months in the year. James Murray records sixteen species of Rotifera collected by himself at Cape Royds, of which the following five species, all Bdelloids, are described as new: *Philodina gregaria*, *P. antarctica*, *P. alata*, *Callidina angularis*, *Adineta grandis*. The author enlarges on the severe conditions under which these Rotifera manage to exist, and it appears that their lives are actually prolonged by being frozen solid for ten months or more, in order to resume an active and merry life during the short succeeding summer. "They do not ask for much in the way of luxury," the author observes; "give them a week or two of warm weather, say + 40° F., and they are content to be frozen up for years." It is not a little surprising to find in these regions *Floscularia cornuta* and *Hylatina senta*, and it may be legitimate to inquire whether Captain Scott's previous expedition had anything to do with the introduction of these species.

Echinoderma.

Indian Ocean Echinoderms.†—F. Jeffrey Bell reports on Echinoderms (other than Holothurians) collected by J. Stanley Gardiner in the Western parts of the Indian Ocean. He describes *Lysaster lorioli* g. et sp. n., a Pentagonasterid having some of the characters of *Iconaster*, and two new species, *Iconaster gardineri* and *Astronyx cooperi*, the latter in general appearance very much like the northern circumpolar form but differing in its radial shields and arm-spines.

Gemmiform Pedicellariæ.‡—A. Gandolfi Hornyold discusses the function of these peculiar pedicellariæ, which occur on the dorsal surface of *Echinocardium flavescens*. It has been shown by Prouho and by Von Uexküll that these are poisonous, and Hornyold made the experiment of placing a small Annelid in their vicinity. They bit it: a red fluid flowed from their tips, and the worm was dead in a few minutes. The pedicellariæ then separated themselves from the test and remained imbedded in the worm. They break off at the same point, at the joint between pedicellaria and test, and they can be regenerated in about a month.

New Zealand Echinoderms.§—W. B. Benham reports on a collection which includes thirteen species of Asteroids, six of Ophiuroids, seven

* Rep. British Antarctic Exped., 1907-9, i. (1910) pp. 41-65.

† Trans. Linn. Soc. (Zool.) xiii. (1909) pp. 17-22 (1 pl.).

‡ Biol. Centralbl., xxx. (1910) pp. 349-52 (1 fig.).

§ Records Canterbury Museum, i. (1909) pp. 1-34 (5 pls.).

of Echinoids, five of Polothuroids, including *Molpadia dendyi* sp. n. Of much interest is the record of *Odontotaster grayi*, previously recorded from Tierra del Fuego—an illustration of the subantarctic nature of much of the New Zealand marine fauna. Some of the other records have a similar interest.

Holothuria forskali in Scottish Waters.*—James Ritchie records the occurrence of this Holothurian, the "cotton-spinner," from Mallaig, towards the southern end of the Sound of Sleat. He quotes from an old description by Peach an account of the way the irritated animal ejects a bunch of threads, which breaks up into a large mass of filaments finer than the finest sewing-cotton, quite effective in entangling even a crab.

Cœlentera.

Development of Nematocysts.†—Ludwig Will has studied this in *Hydra*, *Syncoryne*, *Physalia*, etc., and distinguishes two chief stages. In the first, the secretion-phase, two kinds of secreted material are formed in the plasma of the formative cell; in the second, the differentiation-phase, the complicated structure of the nematocyst is formed out of the homogeneous secreted material. The primordium of the stilet is formed first, then the coils of the lasso, and so on, all from the arrangement of the alveolar structure that appears in the homogeneous secreted substance.

Study of Stinging-cells.‡—Otto Toppe has made a detailed study of the minute structure of the stinging-cells in *Hydra*, *Vellella*, *Tubularia*, *Pennaria*, *Syncoryne*, *Physalia*, *Pelagia*, and *Olinthias*. He uses the characters of the stinging-cells to distinguish the four species of *Hydra*. The process of explosion is discussed at some length, and Toppe's conclusion is that it is begun and in some measure continued by muscular contraction, but that it is completed by the penetration of water into the interior of the capsule, as Iwanzoff and Schneider have maintained.

Antarctic Medusæ.§—E. T. Browne reports on a collection of seventeen species of Hydromedusæ and Scyphomedusæ in almost as many genera. All are either new species, or have been recently described as new species from the Antarctic. Among the anatomical results we may note two. The interior of the stomach of the Hydromedusan genus *Koellikeria* is covered with minute endodermal papillæ, but whether these have the same function as the gastric filaments of Scyphomedusæ is unknown. In a new species of *Sibogita*, the mature gonads, which are in the ectodermal pouch, intrude upon the stomach, which ceases to be a stomach, and is filled up with endoderm and gonads. Some of the author's general conclusions are noteworthy: there is no proof that a single species of Medusa is common to Arctic and Antarctic; there is definite evidence of primitiveness in some Antarctic species, as if the cold slowed evolutionary change; it is doubtful whether there are any "deep sea" Medusæ in the strict sense.

* Ann. Scot. Nat. Hist. (Jan. 1910) pp. 11-12.

† SB. Nat. Ges. Rostock, ii. (1910) 42 pp. (6 figs.).

‡ Zool. Jahrb., xxix. (1910) pp. 190-280 (4 pls.).

§ National Antarctic Exped. (Nat. Hist.) v. (1910) Cœlentera, No. 5, pp. 1-62 (7 pls.).

Madreporaria from Mergui.*—Ruth M. Harrison and Margaret Poole report on the Madrepores of a collection made by J. J. Simpson and R. N. Rudmose-Brown in the Mergui Archipelago. The variable species *Heterocyathus æquicostatus* and *Flabellum rubrum* have many representatives in the collection. A new species, *Balanophyllia diffusa*, is described, and there are notes on various species of *Dendrophyllia*, *Balanophyllia*, and other genera.

Californian Species of Cerianthus.†—H. B. Torrey and F. L. Kleeberger describe three new species—*Cerianthus æstuarii*, *C. benedeni*, and *C. johnsoni*. On the mesenteries of the third and fourth cycles of *C. benedeni*, the branched processes of the mesenterial filaments are loaded with “cnidorhages,” that is to say, with follicles packed with cnidoblasts, which may be of several sorts, the largest and by far the most important equalling in length the diameter of the follicle, and far surpassing all the others in bulk.

Notes on Medusæ of Western Atlantic.‡—H. F. Perkins describes *Cladonema mayeri* sp. n., in its Hydroid and Medusoid stages, and has made a study of their behaviour and reactions (as observed in the moat at Fort Jefferson). The Medusoid is sluggish in its movements, and this may be associated with the fact that the tentacles are laden with concretions. The polyp, growing singly, was so exceedingly delicate that it was almost invisible to the unaided eye. The largest of over a dozen was 1·5 mm. in height.

Perkins also describes *Campanularia macrotheca* sp. n., *Aglaura ciliata*, sp. n., and has notes on *Cassiopea ramachana* and *Polyclonia frondosa* at the Tortugas.

Entry of Zooxanthellæ into Ovum of Millepora.§—J. Mangan shows that zooxanthellæ pass from the parental tissues into the ovum. He also communicates some notes on the structure of the liberated female medusa and on the oogenesis. There is a migration of the nucleus to the periphery, and a casting out of chromatin into the cytoplasm until hardly any remains.

Differentiation and Growth in Aglaophenia.||—H. B. Torrey has studied various species of *Aglaophenia*, at different ages, to test whether the progressive changes observed are dependent on internal conditions, and his result is to establish a correlation between differentiation and growth.

Two Unrecorded ‘Challenger’ Hydroids.¶—James Ritchie found two epizoic hydroids creeping on the type specimens of *Campanularia insignis* Allman, namely, *Lafœa venusta* Allmann and *Aglaophenia cylindrata* Versluys. He also points out that *Campanularia insignis* is the same as *Obelia marginata*, and that the proper name for the species is *Lytosecyphus marginata*.

* Proc. Zool. Soc., 1909, pt. 4 (1910) pp. 897-912 (2 pls.).

† Univ. California Publications, vi. (1909) pp. 115-25 (4 figs.).

‡ Carnegie Inst. Washington, Publication 102 (1909) pp. 133-56 (4 pls.).

§ Quart. Journ. Micr. Sci., liii. (1909) pp. 697-709 (1 pl.).

|| Biol. Bull., xviii. (1910) pp. 138-54 (6 figs.).

¶ Zoologist (July 1909) 4 pp.

New Japanese Corymorpha.*—Iwaji Ikeda describes *Corymorpha tomoensis* sp. n. It is nearly related to *C. nutans*, but differs in the coloration of the hydrosome, the number of proximal tentacles, the number and arrangement of gonosomes, the shape of the medusa-umbrella, and the mode of anastomosis of the longitudinal canals in the hydrocaulus.

Revision of British Museum Hydroids.†—Armand Billard has made a revision of a part of the collection of Hydroids in the British Museum, discussing questions of synonymy, and supplying figures of some insufficiently defined species.

Protozoa.

Structure and Life-history of Fusulinidæ,‡—H. v. Staff has made a thorough study of these extinct Foraminifera, whose climax he associates with an abundance of carbonate of lime in tropical littoral waters (in Upper Carboniferous, Middle Cretaceous, and Eocene). There is distinct proof of dimorphism in *Fusulina*. The significance of fused shells is discussed. The bulk of the memoir is devoted to a careful account of the shell-structure and to an analysis of the factors operative in shell-making.

Notes on Choanoflagellata.§—J. S. Dunkerly has some notes on these rather unfamiliar Protozoa. The mode of ingestion is still disputed. No one has corroborated Saville Kent's observation of a circulation in the hyaline protoplasm of the collar, which caused food particles to pass up the outside and down the inside of the collar. Up to the present conjugation has not been observed in this group of Infusoria. The author refers to some forms which he found at Plymouth, e.g. *Polyæca dumosa* and *Salpingeca napiformis*.

Influence of Ultra-violet Rays on Trypanosomes.¶—H. Bordier and R. Horand have observed the rapid destructive action of ultra-violet rays on *Trypanosoma levisi*. The Trypanosomes become rapidly very granular and shrivelled up. They are transparent and of the same index as the medium, so that it is impossible to find their remains under the ultra-microscope.

Trypanosomiasis in Man in Sumatra.¶¶—C. Elders gives a short account of a Trypanosome which he found in Javanese suffering from fever. It seems to be different from *Trypanosoma gambiense* and other forms.

Study of Nagana Trypanosome.**—Murio Battaglia gives an account of his studies on this important Trypanosome—its structure, pathogenic properties, and life-cycle.

* Annot. Zool. Japon, vii. (1910) pp. 153-64 (1 pl.).

† Ann. Sci. Nat. (Zool.) xi. (1910) pp. 1-64 (24 figs.).

‡ Zoologica, xxii. (1910) heft 58, pp. 1-93 (2 pls. and 62 figs.).

§ Journ. Quekett Micr. Club, 1910, pp. 19-24 (1 pl.).

¶ Comptes Rendus, cl. (1910) pp. 886-7.

¶¶ Centralbl. Bakt. Parasitenk., liii. (1909) pp. 42-3 (1 pl.).

** Tom. cit., pp. 113-69 (14 figs.).

Locomotion of Protists.*—Jungi Yamamoto has studied *Vibrio*, *Spirillum*, *Trypanosoma*, *Bodo*, *Polytoma*, *Opalina*, *Colpidium*, and the like, with particular reference to (1) the proximal basal granule; (2) the "middle piece" of the flagellum or cilium, consisting of the axial filament and a spiral fringe; (3) the distal granule (which is not visibly differentiated in *Polytoma* and *Colpidium*); and (4) the terminal filament. He brings the typical spermatozoon into line with the actively locomotor Protist as regards its locomotor apparatus.

Studies on Trypanosomes.†—A. Laveran and A. Pettit continue their account of *Trypanosoma grosi* from *Mus sylvaticus* and *Trypanosoma microti* from *Microtus arvalis*. These Trypanosomes of mice and voles have a strong resemblance to *Trypanosoma lewisi*, and it remains to be seen whether they have not been derived from that species.

German Anschütz‡ discusses the triple infection of canaries with *Trypanosoma pallidæ*, *Hæmoproteus orizivoræ*, and *Proteosoma*.

Encystation in Crithidia.§—F. Rosenbusch describes in *Crithidia muscæ domesticæ* the gradual passage from the typical flagellate form to an encysted phase. The remarkable retraction and coiling of the flagellum is discussed.

Studies on Spirochæts.—J. F. Selenew|| describes interesting annular and stellate figures formed by *Spirochæta pallida*, and discusses their possible significance. A. Tedeschi¶ has made experiments on the Spirochæt (*S. duttoni*) of African recurrent fever.

Reproduction of Kalpidorhynchus arenicolæ.**—Margaret Robinson makes a contribution towards an account of the reproduction of this Gregarine described by Cunningham from the lobworm. She describes the formation of the first spindle and subsequent divisions, the male and female gametes, the occurrence of multiple associations (which do not seem to come to anything), the structure of the karyosome, and the increase in the number of karyosomes by a kind of internal budding from the chromatin layer.

Cnidosporidia in Mayfly Larvæ.††—L. Léger and Ed. Hesse have found in larvæ of *Ephemera vulgata* representatives of three different genera of Cnidosporidia. One, *Nosema schneideri*, occurs in the epithelial cells of the intestine. The second, *Stempellia mutabilis* g. et sp. n., occurs in the fatty body. It has a peculiar type of sporulation. The third, *Telomyxa glugeiformis* g. et sp. n., occurs in the same place, but never along with the second. It combines characters of Microsporidia and Myxosporidia.

* Centralb. Bakt. Parasitenk., liii. (1909) pp. 38-42 (1 pl. and 1 fig.).

† C.R. Soc. Biol. Paris, lxxviii. (1909) pp. 571-3.

‡ Centralbl. Bakt. Parasitenk., liv. (1910) pp. 328-31 (2 pls.).

§ Op. cit., liii. (1910) pp. 387-93 (1 pl.).

|| Op. cit., liv. (1910) pp. 7-11 (2 pls.).

¶ Tom. cit., pp. 12-21.

** Quart. Journ. Micr. Sci., liv. (1910) pp. 565-76 (1 pl.).

†† Comptes Rendus, cl. (1910) pp. 411-14.

BOTANY.

GENERAL,

Including the Anatomy and Physiology of Seed Plants.

Cytology,

including Cell Contents.

Lithocysts in Ficus.*—O. Renner has examined the cystoliths of various species of the genus *Ficus*, and finds that by far the greater number possess these bodies. They are absent in a few allied species belonging to the section *Eusyce*, and also in an African species of *Urostigma*. The author has classified the species according to the manner of occurrence of the cystoliths. Group i. includes those species in which cystoliths are absent; group ii. includes those where the upper cystoliths are enclosed in long, pointless lithocysts, while the lower ones are in spherical pointed lithocysts; group iii. comprises species where the cystoliths are all enclosed in elongated or spherical lithocysts having a shorter or longer point; group iv. includes the species having cystoliths in somewhat flattened, pointed lithocysts; in group v. the cystoliths are enclosed in stiff, short hairs, while in group vi. they may be either in lithocysts or in the ordinary cells of the upper surface. The results appear to show that the trichromatic lithocysts are more important than the pointless ones, that the most extreme modifications occur among these latter forms, and that there is a probability that they are derived partly from hairs and partly from modified trichomes.

Structure and Development.

Vegetative.

Callus-formations in Nuphar.†—H. v. Alten has studied certain formations found in wounded petioles of *Nuphar luteum* in special relation to the question of thylloses. The larvæ of *Chironimus* apparently make their way through the stomata into the air-spaces of the upper tissues and produce conditions similar to those found in *Nymphæa alba*. There are, however, some important differences. The wounding causes the otherwise fully-grown cells to send hair-like formations out of their free walls, which by division ultimately form bladders. These outgrowths are not found in the air-spaces immediately adjoining the wound, but nearer the interior of the petiole. In the air-canals surrounding the wounded parts are brownish masses of tissue which completely isolate them from the healthy tissues.

The outgrowths themselves are covered with numerous wart-like projections and are partially lignified, but they have no cuticle. Fine octahedral crystals are found in the neighbouring cells. The outgrowths

* Beih. Bot. Centralbl., xxv. (1910) pp. 183–200 (21 figs.).

† Bot. Zeit., lxxviii. (1910) pp. 90–5 (2 figs.).

differ from "thylloses" in that the whole of the free part of the wall grows out, while in true "thylloses" only the outer membrane grows out. The author does not agree with Mellink in regarding these outgrowths as traumatic thylloses, but regards them as special callus-formations which the plant makes for its own protection.

Reproductive.

Morphology of Juniper.*—G. E. Nichols has studied the American *Juniper communis* var. *depressa*, with the following results. The author finds that the staminate cones originate in the summer preceding pollination. The archesporium arises from the hypodermis at the base of the sporophyll, and its outermost cells give rise to the tapetum and inner sporangium-wall; the outer sporangium-wall is derived from epidermal cells. At the completion of the heterotypic division of the microspore mother-cells two resting daughter-nuclei are formed, but no wall ever separates them. The mother-cell eventually forms four cavities within which the microspores are formed. About a year elapses between pollination and fertilisation. The pollen-tube quickly penetrates the nucellus, often branching, and the primary nucleus divides to form a tube-nucleus and generative-cell-nucleus; the latter divides subsequently to form stalk-nucleus and body-cell-nucleus. No true stalk-cell is ever formed. Three or four male cells may be produced from one body-cell, but only two are functional. The female archesporium arises in the lower part of the nucellus, but it cannot be recognised at the time of pollination. Only one archesporial cell becomes a true mother-cell, while non-functional cells give rise to the tapetum. Usually only one nucleus resulting from heterotypic division undergoes homotypic division. There is a two-layered megaspore membrane, and the tapetum persists until prothallial tissue is formed. Four to ten archegonia are formed, all enclosed in a single layer of jacket-cells. Division of the central cell nucleus is simultaneous in all the archegonia of a group. No ventral cell is ever formed. The mature egg-nucleus contains both nucleoli and pseudo-nucleoli. Male and female nuclei fuse during the resting stage, and the fusion nucleus is surrounded by starch derived from the male cell. Usually eight free nuclei are formed before walls appear. The upper cells give rise to suspensors and rosette-cells.

Physiology.

Nutrition and Growth.

Transpiration.†—O. Renner has made numerous experiments dealing with the transpiration of plants under different conditions. The plants used included *Nuphar*, *Hydrangea*, *Aconitum*, *Gentiana*, *Tradescantia*, etc., and experiments were made with varying intensities of light, in motionless atmosphere and during windy weather. The chief results are as follows:—Transpiration is to be regarded as a static diffusion, and is dependent upon and proportional to the difference in aqueous tension of the cells and of the atmosphere. Since this tension is itself dependent

* Beih. Bot. Centralbl., xxv. (1910) pp. 201-41 (10 pls. and 4 figs.).

† Flora, c. (1910) pp. 451-548 (25 figs.).

upon temperature and intensity of light, both these factors are of the highest importance. Of equal importance are atmospheric pressure and movements. The rate of diffusion is proportional to the distance between the surface and the mesophyll-cells containing the largest amount of vapour. The resistance offered to transpiration by the epidermis is negligible. In windy weather transpiration is 2 to 5 times as great as in quiet air; when there is no wind the transpiration is in proportion to the radius of the leaf, but in windy weather it is proportional to the surface of the leaf. Experiments show that in quiet air the cavities are filled with air saturated with aqueous vapour, and the epidermis, not the mesophyll, appears to be the limiting factor. Any condition which tends to narrow the openings of the stomata tends to lessen transpiration, and the same result is attained by the sinking of the stomata and the cuticularising of the deep air-cavities. Xerophytes, when exposed to wind, showed a difference of 30 to 70 p.c. of transpiration less than ordinary plants. Assimilation is affected by all the above-mentioned factors, but in a less degree than transpiration.

Function of Living Cells in Ascent of Sap.*—P. A. Roshardt has experimented with 127 species belonging to the genera of 48 natural orders, representing both Monocotyledons and Dicotyledons, in order to discover whether the living cells of herbaceous plants have any connection with the ascent of sap. Stems, branches, twigs, and leaf-stalks were used, and certain portions were killed by means of steam, ether, or xylol. The author comes to the conclusion that there is no difference between high trees and low growing plants as far as sap ascent is concerned. The experiments in 125 cases tend to show that living elements are necessary for the transport of water in stems and in leaf-stalks. The current continues for some time after the living cells of any particular region have been killed, but it is less, and in the case of leaves is made evident by withering. If the destroyed region is large the result is even more marked. Usually young plants suffer more than older ones from such treatment. No change in the conducting apparatus itself was caused by the experiments, and the withering could only be ascribed to the destruction of the living cells. There is no reason for accepting Ursprung's theory that the living cells tend to prevent lateral loss of water. It is not yet evident which tissues of living cells are of the most importance in promoting the ascent of sap.

CRYPTOGAMS.

Pteridophyta.

(By A. GEPP, M.A., F.L.S.)

Morphology of Phylloglossum.†—H. F. Wernham gives an account of the morphology of *Phylloglossum Drummondii* and discusses the meaning of its structure. He briefly summarises his conclusions thus: 1. *Phylloglossum* shows anatomical signs of being, like *Tmesipteris*, "microphyllous" below, and "megaphyllous" above, thus being intermediate between the Pteropsida and Lycopsidea of Jeffrey. 2. The

* Beih. Bot. Centralbl., pp. 243-357 (2 figs.).

† Ann. Bot. xxiv. (1910) pp. 335-347 (figs.).

general degradation of the vascular system, coupled with the geophilous habit, suggests that *Phylloglossum* has undergone considerable reduction recently in descent. 3. This reduction has led to the complete suppression of the megaphyllous leaves, a condition comparable with that presented by *Ophioglossum simplex*. 4. The similarity in respective habits and structure of *Phylloglossum* and *Isoetes* go to support the Lycopodiinean affinities of the latter. 5. *Phylloglossum*, far from being a primitive form, is highly specialised.

Structure of *Psilotum flaccidum*.*—W. Stiles gives an account of the structure of the aerial shoots of *Psilotum flaccidum*. He sums up his results as follows: 1. The aerial shoots differ from those of *P. triquetrum* in being rounded below, triquetrous above, and then flattened. In the triquetrous part branches are produced in planes successively at right angles; in the flattened part branching is all in one plane. A leaf is constantly associated with stem bifurcation. 2. The stem-stele is band-shaped at base, triquetrous above. In the triquetrous stem the xylem is hexarch, changing to tetrarch in the flattened part. 3. The leaves often receive a vascular supply, and when this is the case with a leaf below the stem-fork, the leaf-trace is given off so that one branch of the stele is practically in the axle of the leaf-trace. 4. Secondary thickening is similar to that in *P. triquetrum*. 5. Mesarch structure occurs occasionally in the lower part of the aerial stem, sometimes in connexion with the leaf-traces. 6. The sporangiophore-trace arises like the leaf, and is continued into the sporangiophore, and terminates in the central tissue between the three confluent sporangia, being thus similar in position to the median bundle in the synangium of *Tmesipteris*. 7. The sporophyll is probably homologous with a foliage leaf; but whether the sporangiophore is foliar in nature or is an organ sui generis is uncertain. 8. The Psilotales are probably allied to the Sphenophyllales and Lycopodiales, but show greater resemblances to the former.

Phylogeny of the Filicales. I. Plagiogyria.†—F. O. Bower begins a series of studies in the phylogeny of the Filicales by the publication of a paper on *Plagiogyria*, which was proposed as a separate genus by Mettenius in 1858, but has been treated by many as a sub-genus of *Lomaria*. Bower gives a detailed account of its structure, derived from a study of the West Indian species, *Plagiogyria semicordata*, and the East Indian *P. pycnophylla* and *P. glauca*; and compares it with other ferns. His conclusions are: 1. *Plagiogyria* is a quite distinct genus. 2. It shows its relatively primitive character in the stelar structure, the undivided leaf-trace, the simple forked venation, occasional dichotomy of the axis, the absence of flattened scales, absence of a "true" indusium, the sorus initially simple but later showing mixed character, the segmentation of sporangium, its thick stalk, oblique annulus, and indeterminate stomium, and the tetrahedral spores. 3. It approaches all the great series of the Simplices, without showing close affinity to any one of them. 4. It may be regarded as the most primitive type of the Pterideæ. 5. Its "mixed" character of sorus, without any indication of a gradate

* Ann. Bot., xxiv. (1910) pp. 373-387 (pl.).

† Tom. cit., pp. 423-450 (2 pls.).

sequence of sporangia, combined with its primitive characters and its probable affinity to the Pterideæ, shows that a great phylum of Mixtæ has probably been derived directly from the Simplices.

Apogamy in *Pteris droogmantiana*.*—E. L. Stephens and M. G. Sykes publish a preliminary note on apogamy in *Pteris droogmantiana*. They have made a cytological investigation of its prothallus. In the young prothallus binucleate cells are common, the extra nucleus not being due to migration but to nuclear division. These nuclear pairs mostly fuse eventually, the resultant nuclei being very large and often lobed at first.

Apogamy, Hybridisation, and Heredity in certain Ferns.†—A. Heilbron publishes a paper divided into three parts, namely, an account of *Cystopteris fragilis* f. *polyapogama* (a new form); the hybrid nature of *Asplenium germanicum*; the conditions of heredity in cultivated garden ferns. He sums up his results as follows:—1. *Cystopteris fragilis* f. *polyapogama* produces prothallia which have the power of developing sporophytes from the egg-cells apogamously one after the other, or exceptionally even alongside one another. 2. The question whether *Asplenium germanicum* is a hybrid of two recent forms is not yet cleared up, although a crossing of *A. septentrionale* ♀ and *A. Ruta-muraria* ♂ produced a plant which stands nearer to *A. germanicum* than any other hitherto known form. 3. Apogamy has been found in certain ferns in which it was previously unknown. Imported British forms of *Athyrium filix-femina* are partly hereditary and partly reversionary forms. Artificial treatment failed to elicit forking of the frond, and spontaneous forking is not inherited.

Fertilisation and Hybridisation in Ferns.‡—W. D. Hoyt discusses the physiological aspects of fertilisation and hybridisation in ferns, and gives an account of some observations made upon the movements and reactions of sperms. He is very sceptical as to the value of the "hybrid" ferns described in recent papers, and suggests that their peculiarity of form may be due to the effect of the particular soil on which they grew, or to other ecological conditions. He sums up his laboratory observations as follows:—1. Entrance of sperms into archegonia was obtained in every combination of species tried. 2. When egg and sperm were of the same species, entrance into 97 archegonia, as shown by sections, resulted in 37 fusions; but when egg and sperm were of different species, entrance into 129 archegonia failed to give a single fusion. A similar result was obtained by replanting prothalli on soil after entrance had occurred. 3. The results obtained, while not disproving the existence of fern hybrids, indicate that conclusions based on the structure of the sporophyte should not be accepted without additional experimental evidence, and show that not every combination of egg and sperm can result in a fusion. 4. Sperms of one species were observed within the archegonia of another species boring against the egg. The failure of such sperms to enter the egg does not seem to be due to any failure of the

* Ann. Bot., xxiv. (1910) p. 487.

† Flora, n.s., i. (1910) pp. 1-42 (43 figs.).

‡ Bot. Gaz., xlix. (1910) pp. 340-70 (figs.).

sperm to perform its part in the process. 5. It seems to be due either to some hindrance interposed by the egg, or to the interaction of egg and sperm. As no means of hindrance was detected, it is presumed that there is an interaction between egg and sperm, probably of both physical and chemical nature. 6. The movements of fern sperms are complex and varied. Their reactions depend on their physiological state, and thus partly on their past experiences. 7. Sperms have a mechanism of response called into play by change of conditions, or by an interference with the normal movements. In such cases they perform a series of complex movements until they die or free themselves from the stimulus. 8. Orientation of the sperms in both the positive and negative reactions is usually attained by a series of gradual swingings of their anterior ends accompanied by a rotation on their axes, and not by a sudden turning toward or away from the stimulant. 9. The observed movements and reactions seem due to the effect of the stimulant on the organism as a whole, and not to the action of different concentrations of the stimulant on local parts of the organism. 10. The reactions of fern sperms thus seem to be of the same kind as those described for Protozoa.

Dryopteris Hybrids in North America.*—M. Slosson refers to R. C. Benedict's paper on the hybrids of *Dryopteris* in the United States, where it is shown that fifteen hybrids are possible between the six species, *D. cristata*, *D. Clintoniana*, *D. Goldiana*, *D. marginalis*, *D. spinulosa* and *D. intermedia*. Twelve of these have been described. Two remain over for study. And the fifteenth, *D. Clintoniana* × *marginalis*, is now described by M. Slosson, and its comparative characters are pointed out.

Orientation of Botrychium Lunaria.†—L. Lämmermayr publishes a note on *Botrychium Lunaria*. He recalls how Prantl divided *Botrychium* into two groups according to the position of the stomata on the sterile frond. In *Eu-Botrychium* the stomata are situated on both sides of the frond; in *Phyllotrichum* only on the underside. This doubtless depends on the orientation of the frond to light. In *Phyllotrichum* the frond is horizontal and dorsiventral, in *Eu-Botrychium* (including *B. Lunaria* and others) it is upright and isolateral. Lämmermayr once put this to the test, and found that out of 43 growing specimens of *B. Lunaria* 18 had the sterile frond situated in a N. to S. plane, 17 in a N.E. to S.W. plane, and 8 in an E. to W. This calls to mind the position assumed by the leaves of the compass-plant.

Zygopteris Grayi.‡—R. Kidston publishes a note on the petiole of the fossil *Zygopteris Grayi* Williamson, with special reference to the so-called "axillary shoot" or branch. He gives a description and figures of the anatomy.

East African Ferns.§—L. Cufino gives a list of Cryptogams collected by F. Gallina in the Italian colony of Erythraea, and among them the three ferns *Adiantum æthiopicum*, *Cheilanthes farinosa*, *Actiniopteris radiata*.

* Bull. Torrey Bot. Club, xxxvii. (1910) pp. 201-3.

† Oesterr. Bot. Zeitschr., lx. (1910) pp. 129-30.

‡ Ann. Bot., xxiv. (1910) pp. 451-55 (pl.).

§ Malpighia, xxiii. (1909) p. 244.

Bryophyta.

(By A. GEPP.)

Vegetative Reproduction in Metzgeria.*—A. W. Evans discusses the question of vegetative reproduction in *Metzgeria*. He describes the gemmæ of twelve species. 1. In five of them, *M. uncigera* (Porto Rico, new), *M. furcata* Dum., *M. quadriseriata* Evans, *M. myriopoda* Lindb., *M. oligotricha* (West Indies, new), the gemmæ are marginal. 2. In six the gemmæ arise from the antical surface of the wings: *M. crassipilis* Evans, *M. vivipara* (Porto Rico, new), *M. Liebmanniana* Lindenb. & Gottsche, *M. dichotoma* Nees, *M. disciformis* (New Zealand, new), *M. linearis* Aust. 3. In one the gemmæ are indefinite in position: *M. fruticulosa* Evans. Other species, including *M. conjugata* and *M. hamata*, seem to be entirely destitute of gemmæ. Evans inserts descriptions of his new species. He compares the gemmæ of *Metzgeria* with those of other Bryophytes, and shows that *Riccardia* (*Aneura*) is the only thalloid genus in which the gemmæ are at all similar, while certain foliose genera (*Raulula*, etc.) have gemmæ still more like those of *Metzgeria*. He finally discusses the conditions under which gemmæ are produced—namely, conditions such as induce regeneration. There is a kind of antagonism between the apical region and the other parts of the plant. The apex has the first claim upon the nutritive processes; but when its activity is checked, then the other parts secure a higher nutrition and exercise their latent faculty for producing gemmæ.

Androgynous Receptacles in Marchantia.†—E. M. Cutting gives an account of some abnormal archeconiophores of *Marchantia* which were partially antheridiiferous. He discusses its meaning, and cites instances of a similar condition in other genera.

Inter-relationships of the Bryophyta.‡—F. Cavers begins a series of papers on this subject by giving an account of the Marchantiaceæ. He sketches the distinguishing characters of each of the three groups—Astroporæ (4 genera), Operculatæ (7), Compositæ (8). He then discusses the phylogeny of the whole group of the Marchantiales, epitomising his conclusions in a genealogical table.

Regeneration in the Hepaticæ.§—A. Coppey gives a résumé of W. Kreh's paper Ueber die Regeneration der Lebermoose.|| By regeneration is meant the power possessed by isolated portions of plants for putting out new shoots of a thalloid or of a foliose character, according to the habit of the original plant. This regeneration is possible in all species studied, either from fragments of thallus, or from ventral scales, or else from fragments of stem, leaves, perianths, arche-gonia, from hairs or from very young rhizoids. In the acrogynous Jungermanniæ the regenerated shoots are all of unicellular origin, with or without a protonema-stage. In the other families the shoots may be either unicellular in origin, or pluri-cellular (and without proto-

* Ann. Bot., xxiv. (1910) pp. 271-303 (figs.).

† Tom. cit., pp. 349-57.

‡ New Phytologist, ix. (1910) pp. 157-86 (figs.).

§ Rev. Bryolog., xxxvii. (1910) pp. 59-62.

|| Nova Acta Abh. k. Leop. Carol. Deutschr. Akad. Naturf., xc. (Halle, 1910) 89 pp.).

nema), or sometimes uni- and sometimes pluri-cellular. 1. In the thalloid hepatics, the Marchantiaceæ can regenerate from thallus, ventral scales, epidermis, and to some extent from the assimilatory tissue. The Anthocerotaceæ regenerate preferably at the vegetative summit. The Ricciaceæ at the apical pole of the thallic fragments, and preferably on the lower face and on the median line. The anacrogynous Jungermanniæ regenerate the nearer to their apical pole, the higher the differentiation of their thallus; and here also on the morphologically lower side and the nerve by preference. 2. In the foliose hepatics, the acrogynous Jungermanniæ may regenerate from fragments of stem, preferably on the median line of the lower surface, often in the axil of the amphigastria (*Bazzania*, *Kantia*, *Chiloscyphus*, *Lophocolea*, etc.). From leaves, if completely detached, they regenerate either over the whole surface, or only at the base, or sometimes at the margin. From detached perianths they regenerate chiefly at the base. Among organs which produce propagula there are two groups: (1) leaves when detached cease producing propagula, and put out regeneration-shoots at the same points as normal leaves; (2) organs bearing discoid pluri-cellular propagula (Brutkuchen) do not cease forming them; on the contrary the propagula, which appear as warts on the leaves (Brutwarzen) are transformed into shoots. Of the sexual organs, the antheridia rapidly perish; but the archegonia readily form shoots, preferably at their base. Kreh has entirely failed to obtain any result from the sporogonium and its stalk. The hepaticæ thus have great powers of regeneration, and in nature benefit much by them. When parts of the plant are detached by insect agency, they sprout and serve as organs of vegetative propagation.

Some Irish Forms of Fissidens.*—H. N. Dixon gives an account of *Fissidens exsul*, a new species from the palm-house in the Botanic Gardens at Glasnevin. It is allied to *F. tequendamense* found near Dublin in 1880 and published under the name of *Schistophyllum Orrii*, and to *Fissidens algarvicus*, but differs in being larger, with more numerous and larger leaves with chlorophyllose cells, and in its longer seta. It differs from *F. incurvus* in leaf-apex, areolation, and peristome. The inner face of the basal part of the peristome of *F. exsul* and of *F. algarvicus* is adorned with a series of remarkable prominent lamellæ, fringed at the margin with cilia. These fringed lamellæ are very difficult to observe, owing to the fragility of the teeth when dry, and to their strongly incurved position when wet. Dixon also describes a new form of *F. rufulus*, from a quarry near Finglas Bridge. It is characterised by great variability in the development of its leaf-border, which may be partly or completely suppressed on the superior and inferior laminae.

Revision of the Species of Philonotis.†—A. Cornet gives a résumé of, and makes some remarks upon, Dismier's *Essai Monographique sur les Philonotis de France.‡* *Philonotis* is a most polymorphic genus, in which the species and their forms have been lamentably confused by

* Journ. Bot., xlviii. (1910) pp. 145-9 (pl.).

† Bull. Soc. Roy. Bot. Belg., xlv. (1909) pp. 307-9.

‡ Mém. Soc. Sci. Nat. Cherbourg, xxxvi. (1908) pp. 367-428.

bryologists of the nineteenth century. Too much importance was attached to such a valueless character as the form and direction of the perigonal leaves; and the parallelism of forms exhibited by some of the species escaped notice. Loeske and Dismier have cleared away many errors. In Dismier's monograph the differential characters of the species are drawn from the form of the cauline leaves, the width of their nerve, the shape and duplication of their teeth, the position of their papillæ, etc. These are constant characters, and taken from the vegetative organs, thus facilitating the naming of sterile specimens. Dismier admits eight species for France:—*P. rigida*, *P. marchica*, *P. capillaris*, *P. cæspitosa*, *P. fontana*, *P. tomentella*, *P. seriata*, *P. calcarea*, and refers sundry other species to them as synonyms.

Heterocladium Macounii.*—I. Thériot discusses the affinities of a Black Forest moss which had been referred to *Heterocladium Macounii*, a North American species. After making a comparative study of authentic material of types and various forms, he was able to come to a definite conclusion. *H. heteropterum* Bry. Eur. possesses certain characters; *H. Macounii* Best possesses certain other characters. The Black Forest plant much approaches the latter. But there are intermediate forms which show that *H. heteropterum* is a polymorphic plant with the Black Forest plant at one extreme of its range of forms—var. *robustum* Zett. *H. heteropterum* is European; *H. Macounii* is American. There is a parallelism of European and American species and forms.

Belgium Forms of Harpidium.†—H. van den Broeck gives a list of the forms of *Harpidium* found in the environs of Antwerp, arranged according to F. Renault's monograph in T. Husnot's *Muscologia gallica*, namely eight species, two of which—*H. aduncum* and *H. fluitans*—are represented by numerous forms.

Sphærocarpos.‡—C. C. Haynes publishes a revision of the genus *Sphærocarpos*, giving descriptions and illustrations of the species, and adding a new species, *S. hians*, from the state of Washington in North America. She also furnishes a key for facilitating the recognition of the species, six in number. One of these, the type, is European; another occurs in North America, Europe, and Tangier; another in the southern United States; another in California; and the remaining one in Chile. In four of the species the spores remain permanently united in tetrads. *Sphærocarpos* being one of the most simply constructed among the hepatics, is of interest and importance from the evolutionary and philogenetic point of view.

Monoselenium tenerum Griffith.§—K. Goebel publishes his thirteenth article of Archegoniata studies, and gives an account of the lost and unknown *Monoselenium tenerum* of Griffith. His summary runs as follows: 1. A very remarkable Marchantiaceous plant from Canton agrees fundamentally with Griffith's *Monoselenium*, which must not be confounded with *Cyathodium*. 2. It is characterised by a total absence

* Rev. Bryolog., xxxvii. (1910) pp. 62-4.

† Bull. Soc. Roy. Bot. Belg., xlvi. (1909) pp. 300-6.

‡ Bull. Torrey Bot. Club, xxxvii. (1910) pp. 215-30 (8 pls.).

§ Flora, n.s., i. (1910) pp. 43-97 (45 figs.).

of air-chambers, which, as in *Dumortiera*, may be due to degeneration. From *Dumortiera* it is distinguished by a series of characters. 3. The reproductive organs are situated on receptacles, which place the genus in the group Compositæ. Antheridial and archegonial receptacles are formed in succession. The antheridial receptacles are thrust aside on to the upper side of the thallus by the early formation of the ventral shoot; and the same may happen to the female receptacle. 4. In the sporogonia the formation of elaters is so reduced that the chlorophyll-containing "elaters" are comparable with the nutrition-cells (Nährzellen) of *Corsinia*, *Sphærocarpus*, and *Riella*. 5. The forms of the Riccia-Marchantiaceæ series which possess dorsal receptacles (Stände), or dorsal antheridia and archegonia not grouped into receptacles, are not, as has been accepted since Leitgeb's time, primitive, but are reduced. This most probably applies to the sporogonia of *Riccia*, which has carried the reduction (begun in *Monoselenium*, *Corsinia*, *Sphærocarpus*, and *Riella*) to such a pitch that the elaters have been completely suppressed. The male receptacles disappeared sooner than the female, losing the independence which in many forms the female partially retain. 6. "Androgynous" receptacles were found not only in *Monoselenium* in different states of development, but also in *Corsinia*. The division of the sexes in Marchantiaceæ is therefore a fairly labile one, as is shown by the much better known examples of *Preissia*, *Dumortiera*, etc.

Dendroceros.*—F. Stephani gives an account of the genus *Dendroceros*. He describes the morphology. The vegetative thallus is of a simple character; but the sporogonium is highly developed and brings the genus near to the true Mosses. Stephani thinks that *Dendroceros* is reduced from some leaf-bearing ancestor, the stem being reduced to a midrib and the leaves to the wing-like laminae. The length of the sporogonium in a given species depends on the size of the thallus. Satisfactory characters for the discrimination of species are found in the stoutness of the midrib, and in the size and form of the external sporogonial cells. Stephani describes twenty-three species.

Scotch Bryophyta.†—J. A. Wheldon and A. Wilson publish a list of Cryptogams collected amongst the Cairngorm Mountains in Inverness and Banff in July 1909, and mostly additional to the list of specimens collected in the same district in 1908. They enumerate sixteen Sphagna, sixty-six mosses, thirty hepatics.

New Records of British Sphagna.‡—E. Armitage publishes some new county records of Sphagna determined by J. A. Wheldon and W. Ingham. They were gathered in Elgin, Easternness, Berkshire, Radnor, Westmorland.

North American Bryophytes.§—C. C. Haynes gives a description and figures of the rare hepatic *Pleuroclada albescens* Spruce, an Alpine species of North Europe and Greenland, which is now recorded from two localities in the Rocky Mountains of the United States.

* SB. Natur. Gesell. Leipzig, xxxv. (1908) pp. 11–21. See also Bot. Zeit., lxxviii. (1910) p. 114.

† Journ. Bot., xlviii. (1910) pp. 123–29.

‡ Tom. cit., p. 163.

§ Bryologist, xiii. (1910) pp. 49–50 (pl.).

J. M. Holzinger* gives an account of a botanical exploring trip (in 1902) on the north shore of Lake Superior in Minnesota, with an enumeration of the mosses collected—namely, 231 species, varieties and forms, many (145) of which are new records for Minnesota. He appends some critical notes by Mons. Thériot on *Hypnum uncinatum* and its forms in North Minnesota.

R. S. Williams † having had to examine carefully several thousands of moss-specimens, protests strongly against the poor quality of the great majority of the specimens, and implores collectors to search for and gather only the best possible examples of such species as they find; it is seldom that the fruit of the various species of *Dicranum* and *Dicranoweisia* is in a perfectly satisfactory condition in herbarium-specimens.

T. C. Frye ‡ gives an account and figures of *Grimmia olympica* E. G. Britton, a new species collected by him high up in the Olympic Mountains of Washington, a locality little known to botanists.

J. L. Sheldon § publishes a list of twenty Connecticut hepaticæ from localities additional to those recorded in the catalogue published by Evans and Nichols. In a second list he gives nineteen hepaticæ from West Virginia, which are additional to those recorded in his previous report of 1907.

Mexican Mosses. ¶—J. Cardot publishes a fifth article on Pringle's Mexican mosses, giving preliminary diagnoses of twenty new species and six new varieties, with critical notes.

Hepaticæ of Madeira. ¶—E. Armitage publishes a list of hepaticæ gathered in Madeira in the first quarter of 1909, and determined by S. M. Macvicar. The list contains thirty-seven species and varieties, fourteen of which are additions to the flora of the island. Previous lists have been published by Mitten, Schiffner, and Luisier.

East African Mosses. **—L. Cufino gives a list of Cryptogams collected by F. Gallina in the Italian colony of Erythraea, and among them the moss *Pleurochæte malacophylla* Broth.

Charles Reid Barnes (1858-1910). ††—Charles Reid Barnes is the subject of an anonymous obituary notice. For twenty-eight years a botanical professor—namely, at Purdue, Wisconsin and Chicago Universities—he was also well known as joint editor of the *Botanical Gazette*, in which his reviews were trenchant but just. His published works treat of laboratory work, plant life, physiology, morphology, keys for the determination of the North American mosses. As a teacher of botany he was unusually successful.

M. A. Howe †† also writes a notice of the above, and makes reference to his *Analytic Keys to the Genera and Species of North American Mosses* and other works.

* *Bryologist*, xiii. (1910) pp. 50-6.

† *Tom. cit.*, pp. 56-7.

‡ *Tom. cit.*, pp. 58-9 (pl.).

§ *Tom. cit.*, pp. 63-5.

¶ *Rev. Bryolog.*, xxxvii. (1910) pp. 49-59.

¶ *Journ. Bot.*, xlvi. (1910) pp. 156-8.

** *Malpighia*, xxiii. (1909) pp. 244-5.

†† *Bot. Gaz.*, xlix. (1910) pp. 321-4 (portrait).

†† *Bryologist*, xiii (1910) pp. 66-7.

George Stabler and J. M. Barnes.*—C. H. Waddell publishes an obituary notice (with portrait) of George Stabler (born 1839, died 1910), bryologist, and for many years schoolmaster at Levens, Westmorland. A schoolfellow of the late Richard Spruce, he acquired from him his love of hepatics. With J. M. Barnes and J. A. Martindale he explored carefully much of the Lake District for mosses, ferns, and lichens, and published papers on the Bryophytes in the *Naturalist* in 1888–1898. In his later years he became totally blind. The following British species were named after him: *Plagiochila Stableri*, *Marsipella Stableri*, *Anthoceros Stableri*; also the genus *Stableria* of Lindberg.

Waddell also gives a similar account of James Martindale Barnes (born 1814, died 1890), a neighbour of Stabler, and expert collector of ferns and, later, mosses, in Westmorland. His moss-collection is in Kendal Museum. *Bryum Barnesii* was named after him.

Thallophyta.

Algæ.

(By MRS. E. S. GEPP.)

The Roscoff Laboratory.†—J. Chalon writes an interesting account of the marine station for biology at Roscoff, giving details of the building, the management, the rules, and the facilities for work. A certain number of students can be accommodated within the station itself, and the charge for this is extremely small. All the necessary appliances for work are provided gratuitously. Much good work has already been carried on at Roscoff, and it is confidently expected that many more students will avail themselves of the exceedingly good conditions to be found there. The author adds a list of the 330 species of marine algæ already recorded from the region.

Greenland Fresh-water Algæ.‡—F. Börgesen publishes a list of seventy-six species of fresh-water algæ collected by the Danish Expedition to the north-east coast of Greenland. The material is rather poor, both as to quantity and quality, and even in those samples which contained a great number of species the number of individuals was small. The author attributes this poverty to the faulty manner of collecting, and refrains therefore from making any detailed comparison between the species recorded from East and West Greenland. Among the finds of interest is *Spirotænia*, which is new to the country, represented by *S. condensata*. Another new record for Greenland is *Euastrum tetralobum* Nordst., while *Cosmarium spitsbergense* Nordst. has hitherto been found only once in Greenland. *Nostoc commune* appears to be very common, even large specimens being found along the border of lakes or on places which are quite dry in summer. No material of snow-algæ was brought home.

* *Journ. Bot.*, xlviii. (1910) pp. 160–2 (portrait).

† *Bull. Soc. Roy. Belg.*, xlvi. (1909) pp. 224–249, 377–380 (4 pls.).

‡ *Danmark-Ekspeditionen til Grønlands Nordøstkyst, 1906–8* (iii.) in *Meddel om Grønland*, xliii. (1910) pp. 71–90.

Marine Algæ from North-East Greenland.*—L. K. Rosenvinge writes on the marine algæ collected by the Danish Expedition on the north-east coast of Greenland. He records sixty species, besides two undetermined: five species are new to Greenland and three new to science. A well developed sublittoral vegetation seems to exist at several places in the explored area. Thus, *Fucus inflatus* forms a vegetation at a few metres depth under low-water mark, the Laminariaceæ form true associations at a somewhat greater depth, and the Floridaceæ are predominant at other places mostly in still greater depths. One of the most abundant species is *Desmarestia viridis*. Of the encrusting algæ, *Lithothamnion læve* is the most common, and fairly frequent are also *L. glaciale*, *L. fecundum*, *Lithoderma fatiscens*, *Cruoria arctica*, and *Rhodermis elegans*. Finally the author discusses the flora of Greenland, and compares the different areas.

Sulphur-flora of Lemberg.†—W. Szafer records ten species of Schizophyceæ from some of the sulphur springs in the neighbourhood of Lemberg. The genera represented are *Aphanothece* and *Oscillatoria*, and of the species enumerated six are new.

Gleothece rupestris.‡—J. Brunthaler has made a study of the effect of external factors on *Gleothece rupestris*, and publishes his results. His cultures were made with organic and inorganic compounds respectively, both in darkness and light. The author finds that the two varieties of *G. rupestris* are brought about by external influences, the var. *cavernarum* Hansg. being produced by a weak light and var. *tepidariorum* by a rise in temperature. *G. rupestris* grows as well on inorganic as on organic nutrition, and retains the power of becoming green under either condition. Light is on the whole more favourable to cultures in inorganic solution than to those in organic and in nitrate- or phosphate-containing solutions. In most of the cultures light had no influence on the size of the cells. Warmth causes a diminution of the families and an enlargement of the cells; at the same time the cell-contents become darker. A firm substratum encourages growth.

Ceratium hirundinella.§—E. Werner writes on the structure of the frustule of *C. hirundinella*, describing the plates and their junction. Her material consisted of a form of the species collected in the Sea of Tiberias by Magnus, in which one of the horns was suppressed. The plates composing the frustule do not overlap at all, but merely lie in close contact, probably attached by means of a cement. In a weak solution of potassium hydrate they drop apart. Details and figures are given of the general structure, number and form of the plates, etc.

Closterium.||—B. F. Lutman writes on the cell-structure of *Closterium Ehrenbergii* and *C. moniliferum*. After an historical account of previous work on the subject he describes his methods, and then deals with the chromatophore, the pyrenoids, and the nucleus in detail. He

* Meddel. om Grønland, xliii. (1910) pp. 93-133 (figs. in text).

† Bull. Internat. Acad. Sci. Cracovie, 1910, pp. 161-7 (1 pl.).

‡ SB. Akad. Wiss. Wien, cxviii. (1909) pp. 501-73 (3 pls.). See also Bot. Zeit. lxxviii. (1910) pp. 110-11.

§ Ber. Deutsch. Bot. Gesell., xxviii. (1910) pp. 103-7.

|| Bot. Gaz., xlix. (1910) pp. 241-55 (2 pls.).

summarises his results as follows :—1. The current figures and descriptions of the chromatophore of *Closterium* derived from Naegeli are fundamentally incorrect. The chromatophore is not made up of a series of radiating plates about a slender central core, but is a curved cone-shaped structure with relatively narrow ridges on its surface. 2. The pyrenoids are imbedded in the periphery of this chromatophore in *C. Ehrenbergii* and exactly at its centre in *C. moniliferum*. 3. Pyrenoid starch and stroma starch both have the same origin, all the starch being formed around pyrenoids. 4. The pyrenoids show considerable internal structure, frequently containing denser and lighter portions, vacuoles, etc., and often are cleft into a mass of disks or segments of varying number and form.

Trentepohlia.*—F. Brand discusses the various sporangia of the genus *Trentepohlia*, of which he finds three different kinds, the difference lying not in the form of the sporangium itself, but in the form of the cell which bears it. Thus there is :—1. The sessile sporangium, which may be terminal, lateral, or intercalary, possesses no marked annular thickenings on its dividing wall, is never separated from the filament, and empties its spores in situ. 2. The pedicellate sporangium, which does not arise direct from a vegetative cell, but is divided off from the apex of a filamentous outgrowth of the somewhat swollen sporangiophore. This type occurs only apically or laterally on the filaments, has mostly concentric rings of thickening in the septum, and before the escape of the spores breaks away from its stalk. 3. A short membranous funnel is formed on the cylindrical sporangiophore by subapical constrictions. Inside the funnel the young sporangium is divided off by a wall, which has two annular thickenings one over the other. This is called the funnel-sporangium, and is always apical. It always falls off from the sporangiophore before the escape of the spores. Details of these three forms of sporangia are given, and instances are quoted. Further, the author adds some notes on *T. annulata* Brand, which he has found in a new locality, and on the culture of *Trentepohlia*.

Cystosira and *Sargassum*.†—W. Nienburg has re-investigated the development of the conceptacles and oogonia of *Sargassum* and *Cystosira*, previously worked out by E. B. Simons, and finds that her conclusions as to the formation of the conceptacle are, as was to be expected, quite correct. She found that the early stages of the conceptacle in *Sargassum Filipendula* differ somewhat from those of other Fucaceous genera, described by Bower and Oltmanns. The same holds good for *Cystosira barbata*. As regards the development of the oogonia, the author of this paper does not quite agree with E. B. Simons, and sets forth the points on which he differs. He finds that the oogonia of both *Cystosira* and *Sargassum* show the usual nuclear division into three, and that in the former there follows a reduction of the chromosomes. Therefore these two genera are not exceptions to the rule, which apparently holds good for all Fucaceæ, that in the cycle of their development an x -generation enclosed in the oogonium alternates with a $2x$ -generation.

* Ber. Deutsch. Bot. Gesell. xxviii. (1910) pp. 83-91 (1 pl.).

† Flora, n.s., i. (1910) pp. 167-80 (figs. in text).

West Indian Florideæ.*—F. Börgesen continues to publish notes on new or little known West Indian Florideæ. The new species described are *Chantransia bispora* and *Chrysymenia pyriformis*, and a new genus *Celarthrum* is founded on *Chylocladia Albertisii* Piccone. The author finds that the glands of *Chrysymenia* are of different form and arranged differently in each species, thus forming a good specific distinction. Several other species are discussed in detail.

Secondary Attachment in Florideæ.†—J. Menz has made a careful study of the secondary attachment which is found in certain Florideæ. She considers that the principal points to be worked out are: 1. What elements of the thallus take part in secondary attachment? 2. Under what circumstances does the substratum remain passive? 3. Does the substratum influence the manner of the attachment? 4. Does the occurrence of secondary attachment depend at all on the nature of the substratum? These questions are all satisfactorily and clearly answered, as the result of the author's work. She describes her investigation of *Nitophyllum punctatum*, *Rhodymenia ligulata*, and *Hypnea musciformis*, and finally gives full answers to all her questions. 1. In species which have a thallus of one layer only, that layer, of course, produces the attachment-hyphæ, and in parts where the thallus is more than one layer thick, only the outermost cell-layers, which are turned towards the substratum, take part in the work. Where there is a definite cortical layer, the cortical cells grow out into hyphæ, as in *Rhodymenia*, *Poly-siphonia*, *Hypnea*, and *Spyridia*. 2. The substratum only takes an active part in the attachment when two portions of the same plant, or of the same species, adhere. In all other cases the substratum remains quite passive, merely acting as support to the epiphyte, and not even undergoing any modification. The epiphyte may form "stempel"-shaped rhizoids (*Ceramium* on *Rhodymenia*), or the individual hyphæ may coalesce to form a disk-shaped attachment (*Hypnea* on *Sargassum*). Similar growths are formed by a more or less active increase of the cortical cells, as in *Rhodymenia*, which retain, however, their original form. 3. The manner of the attachment is not varied, according to the substratum. 4. On the other hand an influence of the substratum on the formation of the organs of attachment may be observed, since not every substratum seems adapted in the same way to produce growth at the points of contact. Such an instance is found in *Colpomenia sinuosa* bearing as epiphyte a species of *Nitophyllum*. In the parts where *Nitophyllum* touches the chromatophore-bearing cells of the *Colpomenia* cortex it grows out in the usual way to form hyphæ of attachment; but where the *Nitophyllum* thallus comes into contact with the hairs of *Colpomenia*, the *Nitophyllum* cells remain quite passive, or nearly so, and merely grow intermingled with the *Colpomenia* hairs. A section through such a connection is figured.

Symbiosis between Algæ and Sponges.‡—A. Weber van Bosse describes two new species of *Thamnoctonium* which live in symbiosis

* Bot. Tidsskr., xxx. (1910) pp. 177-207.

† Oesterr. Bot. Zeitschr., lx. (1910) pp. 103-12, 136-40 (figs. in text).

‡ Ann. Jard. Bot. Buitenzorg, ser. 2, supp. iii. (1910) pp. 537-94 (2 pls.).

with a sponge. They both come from the East Indian Archipelago, and entirely dispel the doubt cast by Oltmanns (Morph. u. Biol. der Algen II., p. 373), that genuine cases of such symbiosis exist. The author describes the structure of the two species, and finds that they both possess chains of moniliform cells, hitherto unknown for *Thamnoclonium*. These cells she describes in detail, and sets forth the various points of interest in connexion with them. On the ground of possessing these peculiar chains of cells, she separates the two new species from the rest of the genus, placing them in a section Nematophoræ, the other species being Anematophoræ. Between the two sections there exists also an anatomical difference, which is described.

Fossil Algæ.*—L. Cayeux has made a study of the calcareous algæ of the *Girvanella* group, and of the oolites in which they are found. In this short note he summarises briefly the views of other authors, and then describes his own conclusions. He proves that the *Girvanella* are in reality a group of perforating algæ, which inhabit the oolites in the manner of parasites; and that the concentric structures in the host-bodies have no connexion with the invading alga, but belong to the oolitic mass. The views of Wethered are not in accordance with those of the author of this paper, and they are shown to be incorrect.

Fungi.

(By A. LORRAIN SMITH, F.L.S.)

New Genus of Chytridinae.†—R. F. Griggs found the new fungus on the leaf-blades and petioles of the ragweed (*Ambrosia artemisiifolia*). The swarm-spores perforate the cells, and enter the tissue of the plant in great numbers as amœboid forms. They unite in pairs, the nuclei remaining distinct, and finally the fused amœbæ become a binucleate resting-spore with a stout exospore wall. Germination has not been studied. Other swarm-spores grow to form zoosporangia, the first nucleus being said to fragment into four nuclei at an early stage; finally, after successive divisions, minute zoospores are formed. The escape of the zoospores was not observed, and the author is not certain if they are ciliate or amœboid, but probably they are amœboid. He calls the fungus *Monochytrium Stevensianum* g. et sp. n. Though the infected cells increase in size, very little deformity of the host-plant takes place.

Phytophthora infestans.‡—D. McAlpine has devoted considerable attention to this destructive fungus. He sums up in a series of statements the results of his investigations: that only seed potatoes free from disease should be used, and that these should be carried in new bags; that as tomatoes are also liable to the disease, they should not be grown on infected areas; that the fungus in suitable conditions develops very rapidly, but may be checked and killed by spraying with Bordeaux mixture, or the tubers may be rendered superficially clean by dipping in formalin. He gives special notes on the action of heat and moisture

* Comptes Rendus, cl. (1910) pp. 359-62.

† Ohio Nat., x. (1910) pp. 44-54 (2 pls.). See also Bot. Gaz., xlix. (1910) pp. 311-12.

‡ Ann. Mycol., viii. (1910) pp. 156-66 (1 pl.).

on the development of the fungus; the formation of sporangia may be prevented by a dry heat of 27° C., though a moist heat at the same temperature favours growth, and he found also that sporangia lose their vitality if kept dry for twenty hours. Zoospores perish in the same conditions in twenty-four hours. McAlpine argues from these facts that the disease could not be spread to any great distance by wind-borne spores or sporangia. Diseased potatoes can be completely sterilized without harming the tuber by being subjected to a dry heat of 48–50° C. for four hours.

Study of Balsamineæ.*—Feodor Bucholtz has examined young stages of the subterranean Ascomycete *Balsamia*. The interior is occupied by chambers, of which the walls lined by the hymenium are irregularly infolded. He found at an early stage that there was evidence of several openings, thus indicating connection with Tuberaceæ rather than with Pezizaceæ. He gives an account of a number of allied genera that he studied, especially *Hydnocystis*, which has a structure somewhat like that of *Balsamia*, and an apical opening. Bucholtz finds that the Tuberineæ form a connecting link between the Pezizineæ and Helvellineæ.

Development of Truffles.†—G. Boyer has studied the question of truffle growth for some years. The young tubercles of *Tuber melanosporum* (the species more particularly studied) appear towards the end of July or in August, and when first detected they were no larger than a small pea; afterwards they may reach the size of an orange. Though there were no connexions seen with mycelial network, on the surface of the tubercle small isolated fragments of mycelium could be detected by the Microscope. If the truffles were moved they ceased to grow, no matter in what soil they were placed, proving, as Boyer considers, their close association with the roots of the trees called "truffle trees."

New Observations on Ergot.‡—Rob. Stager has studied *Claviceps microcephala*, the form of Ergot on *Phragmites communis*. He describes the species, and finds that it has a biological form which grows only on *Poa annua*. He also gives a series of new hosts for *Claviceps purpurea*, and discusses the propagation of the fungus by means of insects.

Oak Mildew.§—Griffon and Maublanc have studied the oak mildew, *Oidium quercinum* Thüm., and they have concluded that the recent attack which has been so widespread in Europe and so destructive, is due to another mildew which they have named *Oidium alphitoides*, an exotic species newly introduced. They do not consider that it is a stage of *Microsphaera Alni*; the perfect fruit form is so far unknown. Careful measurements and comparisons of the different species are given by the authors.

Two Epidemic Mildew Diseases.||—Boleslau Namyslowski records the occurrence of gooseberry mildew, *Sphærotheca mors-uvæ*, in the neighbourhood of Krakau, due as is supposed to the gradual normal

* Ann. Mycol., viii. (1910) pp. 121–41 (1 pl. and 32 figs.).

† Comptes Rendus, cl. (1910) pp. 1253–6.

‡ Centralbl. Bakt., xxvii. (1909) pp. 67–73.

§ Bull. Soc. Mycol. France, xxvi. (1910) pp. 132–7 (1 fig.).

|| Zeitschr. Pflanzenkr., xx. (1910) pp. 236–8.

spread of such a disease, as for several years it had been known in districts near. The author also comments on the oak mildew: only the conidial form was found, no perithecia, though they were diligently looked for. He discusses the name and affinities of the fungus, and does not consider it to be identical with Thümen's *Oidium quercinum*.

Stroma-formation in *Xylaria Hypoxylon*.*—D. Linford Freeman has grown the stromata of this fungus in various substrata and in varying conditions to test the factors that influence their growth. As culture media, wood, gelatin, and agar were used successfully; sand soaked in culture solutions did not give good results. Freeman secured germination of ascospores, but not of conidiospores. He describes the development of mycelia and stromata on agar, and compares the influence of light and darkness; in the latter condition, though the mycelium developed well, the stromata were small. Light acted favourably on the growth of the stromata, and they were proved to be positively heliotropic. The changes induced by wounding the stromata are fully described; very irregular branching was provoked by this means. Another phenomenon noted was the growing together of neighbouring stromata, especially at the apex.

Critical Notes on Yeast Researches.†—A. Guilliermond reviews the recent literature on this subject, and draws up a series of pronouncements of his own opinions and conclusions. 1. The nucleus of the yeast-cell always divides by amitosis during budding. 2. The yeast-nucleus consists of colourless nucleo-hyaloplasm surrounded by a coloured membrane. It contains a large nucleolus and a chromatic framework. 3. The yeast-cell contains two series of secretory grains: metachromatic corpuscles lodged in the vacuoles, and granules stained by iron-hæmatoxylin which are dispersed through the protoplasm, and are called by Guilliermond "basophil grains." They are probably albuminoid bodies, products of nutrition. 4. It has not been possible to observe nuclear division in the ascus, but probably it is mitotic. 5. The epiplasm of the ascus contains large quantities of glycogen, fats, and metachromatic corpuscles which constitute a reserve necessary for the formation of the spores. 6. There is no extra-sporal nucleus in the epiplasm. 7. There has been observed, in the conjugation of the spores in the Yeast Johannisberg II., certain figures where the two nuclei remain in contact and seem to divide simultaneously by amitosis during the budding of the zygospore, becoming united only in later cells as if there had been a synkarian formation.

In a final note the author denies the correctness of Wager's and Peniston's views as to the structure of the yeast-nucleus, and gives his reasons for dissenting from their conclusions.

Hypomyces.‡—In this recent fascicle G. Lindau continues his study of revised forms. A large number of species, described in recent years, are added, and notes given referring to new habitats or to descriptions not already included. A number of new genera have been added, and these are published with descriptions and figures.

* Ann. Mycol., viii. (1910) pp. 192-211 (14 figs.).

† Centralbl. Bakt., xxvi. (1909) pp. 577-59 (6 figs.).

‡ Rabenhorst's Krypt. Flora, 9^{te} Abt., Lief. 117 (Leipzig, 1910) pp. 153-816.

Growths of Moulds in Oil.*—Henri Coupin noted that if any organic body were dropped to the bottom of a flask of oil, *Penicillium glaucum* was formed on it, and produced normal conidiophores and conidia, and he contrasts this with the growth of the same fungus under water: in the latter case the mould produces only mycelium. He made experiments with a series of moulds, various Mucorini, as well as with *Penicillium*, *Cephalothecium roseum*, and *Botrytis cinerea*. They all grew on sterilized carrot immersed in oil, but the mycelium remained short, and evidently was nourished by the carrot and not by the oil. In the majority of cases the mycelium remained sterile. In the cases where fructifications were formed, they were deformed (*Sporodinia*), or they were less abundant than in the air (*Penicillium* and *Cunninghamiella*). No resting-spores or sclerotia were formed in the oil. On the whole, the vegetation of moulds under oil is more like the growth under water than aerial growth.

Uredineæ.†—O. Morgenthaler has investigated the conditions affecting the formation of teleutospores, more especially in connection with *Uromyces Veratri-homogyne*. He finds that it depends on the condition of the host-plant whether teleutospores or uredospores will be formed. As a rule, uredospores were formed after infecting young leaves either with uredospores or æcidiospores; if older leaves were infected with the same spore-material, teleutospores were developed. Any disturbance of nourishment induces the formation of teleutospores.

In another paper‡ he gives the results of a long series of culture experiments on the same subject, viz. the connexion between the formation of teleutospores and the condition of the host-plant; he found that a sickly state of the host, or advanced age and approaching withering, tended to restrict uredo-formation and encourage teleutospores.

Sexuality of Rust Fungi.§—L. Kurssanow has studied to throw further light on a somewhat debated subject. Olive held that there was fusion in the acidium between two fertile cells that differed in size: that on conjugation there was either a large passage through which the cell-contents passed, or that only the nucleus found its way into the receptive cell. L. Kurssanow chose *Puccinia peckiana*, a similar form to those examined by Olive and Christman. Spermogonia are formed below the epidermis, and are followed on the under side of the leaves by the caoma, a confused tissue of hyphæ, from which arise palisade-like cells with large nuclei. These palisade-cells divide into an upper sterile and an under fertile cell. The fertile cells conjugate in pairs by a large opening in the cell-wall; the sterile cells disappear. Kurssanow could find no difference between the fertile cells; all of them possessed the upper sterile cell. He did not attach importance to the passage of a nucleus from a vegetative cell to a neighbouring fertile cell; he considered that to be a result of the artificial conditions.

From each bi-nucleate fertile cell rises a row of æcidiospores, but

* Comptes Rendus, cl. (1910) pp. 1192-3.

† Arch. Sci. Phys. Nat. Genève, xxviii. (1909) pp. 489-99. See also Bot. Centralbl., cxiii. (1910) p. 448.

‡ Centralbl. Bakt., xxvii. (1910) pp. 73-92 (18 figs.).

§ Zeitschr. Bot., ii. (1910) pp. 81-93 (1 pl.). See also Centralbl. Bakt., xxvi. (1910) pp. 691-2.

the observations on this formation do not differ from those of other workers. The author does not consider the upper sterile cell as a trichogyne, as it is present on all palisade rows irrespectively, or sometimes fails altogether: he looks on it merely as a "buffer" cell between the fertile cell and the epidermis.

Ustilago bulgarica sp. n.*—Fr. Bubak records the finding of this fungus on Millet. The spore-mass is greenish-brown, and is developed only in the fruit, which it changes to short horn-like bodies, the surface of which is somewhat wrinkled and covered by the grey epidermis. The spores are clear olive-brown, with a thin, smooth membrane. Bubak supposes that the fungus may have been introduced into Bulgaria with foreign seed.

Classification of Russulæ.†—R. Maire comments on the confusion existing as to the determination of species of *Russula*; he sketches the work done on this genus by modern mycologists, and gives an account of the various divisions of the genus adopted by Persoon, Fries, Quélet, Masee, and Bataille. Maire has studied *Russulæ* for some years, and explains his views on the subject, and his own methods of determination. For general characters he studied the size, consistence, taste, odour, colour and its changes, tint of spores in the mass, the different characters of the stipe and gills, and, finally, the microscopic characters of the internal tissues of the vegetative body, and, more particularly, of the hymenial tissues and spores. Several chemical reagents have been found useful in distinguishing between allied species, and their action is explained and the methods of applying them. A number of species are carefully described in the way considered necessary by Maire, with figures of cystidia, hyphæ, spores, etc.

Armillaria mucida.‡—C. E. C. Fischer undertook experimental work on this fungus to decide the question of its parasitism. He failed to do this, as none of the inoculations on living trees took effect. He grew the fungus saprophytically on a variety of substances, and gives an interesting series of notes on its growth and development. No secondary spore-forms were observed.

Geotropism and Growth in Length of Coprinus stiriacus.§—Fritz Knoll states that growth in length in the stalk of the above *Coprinus* is brought about by the stretching of the cells, and the outer cells develop more quickly than the inner. *Coprinus* is ageotropic, except shortly before or during the shedding of the spores.

Coniophora cerebella as Timber-destroyer.||—This fungus was found by E. Schaffnit to be destroying the beams of a house in the autumn of 1906. It was kept under observation the following years and the development of the disease was carefully followed. The wood was destroyed in much the same way as by *Merulius*. Schaffnit found that the timber

* Zeitschr. Landw. Versuch. Oesterr., xiii. (1910) p. 53. See also Centralbl. Bakt., xxvi. (1910) pp. 695-6.

† Bull. Soc. Mycol. France, xxvi. (1910) pp. 49-125 (6 figs.).

‡ Ann. Bot., xxiii. (1909) pp. 515-55 (2 pls.).

§ SB. k. Akad. Wiss. Wien, lxxviii. (1909) pp. 575-634.

|| Centralbl. Bakt., xxvi. (1910) pp. 352-6 (1 pl.).

attacked was either imperfectly dry when used for building, or the conditions it was subject to in the building itself induced dampness and encouraged the growth of the fungus.

Fomes lucidus, a Root-disease of the Coconut Palm.*—T. Petch has investigated this disease, one of long standing, which has now and again caused the death of the Palms. The first symptoms of the disease are the withering and drooping of the outer leaves and the failure of the nuts to set, the tree becoming barren. When examined microscopically the root tissues were found to be invaded by mycelium, and a culture of the diseased roots produced the well-known sporophores of *Fomes lucidus*. Petch says there is little hope of saving a tree attacked; he recommends that such trees should be cut down and carefully burned; a trench should be cut 2 feet deep round the diseased tree, and the hole from which the tree has been dug should be left open for a year at least.

Notes on the Larger Fungi.†—The series of coloured plates is continued in the Journal of the Board of Agriculture. Three plates are published of species of *Lepiota* and *Amanitopsis*, with descriptions, habitat, etc.

G. Massee ‡ describes a new species of *Marasmius* named *M. Raffillii*, that was found growing in Kew Gardens. The fungus is distinguished by its excentric stem and is probably exotic. This is recorded in the Additions to the Wild Fauna and Flora of the Royal Botanic Gardens, Kew.

A fourth set§ of three coloured plates of edible fungi has been issued by the Board of Agriculture. These are:—*Tricholoma personatum*, *Clitocybe maxima* and *Tricholoma nudum*. Popular descriptions of these fungi are published with the plates.

Assimilation of Nitrogen by Yeast Fungus.||—H. Zikes conducted his research with a yeast belonging to the Fungi imperfecti which he has determined as *Torula Wiesneri* sp. n. He grew the yeast in glucose solutions free from nitrogen, and found that after growth the solution contained perceptible quantities of nitrogen. The paper is accompanied by an extensive bibliography of the subject.

Mycological Notes.¶—C. G. Lloyd publishes a sketch of the life and work of the distinguished mycologist, G. Bresadola. An account is given of the Polypores in Persoon's herbarium at Leyden with notes on species now classified under *Polyporus*, *Polystictus*, *Fomes*, *Trametes* and *Poria*, and finally a description of *Geaster Dybowski*, a species very near to *G. velutinum*, of which it may be a form with a striated opening.

New or Critical Fungi.**—F. von Hönel has published further extensive notes on a large number of genera and species, mostly collected in Java. The notes include criticisms and comparisons of previously

* Circ. Agric. Journ. R. Bot. Gard. Ceylon, iv. No. 24 (1910) pp. 323-36.

† Journ. Board Agric., xvii. (1910) pp. 45-6.

‡ Kew Bull., 1909, pp. 373-6.

§ Journ. Board. Agric., xvii. (1910) pp. 126-7.

¶ SB. Akad. Wiss. Math.-Nat. Kl., cxviii. (1909) pp. 1091-1133.

¶ Cincinnati, No. 35 (1910) pp. 462-76 (6 figs.).

** SB. Akad. Wiss. Math.-Nat. Kl., cxviii. (1909) pp. 1157-1246 (2 pls. and 1 fig.).

named species, and descriptions of new ones. The new genera are :—*Dimerosporiella* (Hypocreaceæ), *Treubionomyces* (Nectriaceæ), *Bombardiella* (Sordariaceæ), *Pseudorhynchia* (Ceratomyceæ), *Mycoglyphus* (Ostropaceæ), *Apiosphæria* (Hyponectriaceæ), *Lecideopsella* and *Aggyronella* (Agryciæ), *Sclerophoma* (Sphaeropsidaceæ), and *Linodochium* (Tuberculariaceæ).

In a further paper* he continues his study of species, chiefly of microfungi, and again he determines a number of new genera: *Valetoniella* (Trichosphaeriaceæ), *Coronophorella* (formerly *Euchnoa*), *Hysterothois*, *Phæochora*, and *Coccochora* (formerly included in *Auerswaldia*), *Cyclodomus* and *Phæodomus* (Sphaeriaceæ), and *Sirozothiella* (Nectriaceæ).

Fungi of the Clyde Area.†—D. A. Boyd gives a descriptive list of fungi which are new to science, or new records for Britain. With one exception, *Erinella pommeranica*, they were all collected by the author.

A note is also published‡ of the fungi collected at Ardlamont, Ardgowan, and Shilford Wood in September and October of the previous year. The lists included from Ardgowan thirty-five Hymenomyces, and from Shilford Wood twenty-six Hymenomyces, three Gastromyces, and thirty-five microfungi.

Breaking up of Cyanamides by Fungi.§—H. Cappen has proved that five different filamentous fungi have the power to break up cyanamides, very little organic nourishment being required in the process. The reaction of the poison on the fungi varied for the different species; in some cases the fungi developed, while it destroyed 2 p.c. of the cyanamide in culture medium; with other species all growth stopped above 1 p.c. of the mixture. The research also touched on the formation of urca and the breaking up of calcium nitrates in the soil.

Text-book of Plant Diseases.||—The increase of study and knowledge about fungoid plant diseases has necessitated a new and enlarged edition of the text-book issued by G. Massee. In this volume he includes foreign as well as British plants, and has thus widened the scope of the book. In addition to fungoid diseases he touches on malformations, injuries by frost, insects, etc., and gives directions as to the use of fungicides. The book will be found to be indispensable to all engaged in the cultivation of plants.

Phytophthora Disease of Pears.¶—Fr. Bubak describes the occurrence of *Phytophthora cactorum* Leb. (= *P. omnivora* De Bary) on pears. The fruits were discoloured, and on microscopic examination were found to be attacked by the *Phytophthora*. The flesh of the pears remained hard, but was turned to a brown colour about a centimetre in depth below the skin, and gradually shrivelled up; the oospores were found in the tissues, the sporangia on the surface. Bubak recommends careful destruction of all fallen fruit.

* SB. Akad. Wiss. Math.-Nat. Kl., cxviii. (1909) pp. 1461-1552 (1 fig.).

† Glasgow Nat., i. (1909) pp. 110-15.

‡ Tom. cit., pp. 139-40.

§ Centralbl. Bakt., xxvi. (1910) pp. 633-43.

|| Diseases of Cultivated Plants and Trees. London: Duckworth and Co. (1910) viii. and 602 pp. (171 figs.).

¶ Zeitschr. Pflanzenkr., xx. (1910) pp. 277-61 (1 pl. and 2 figs.).

Two Diseases of Gooseberry Bushes.*—F. T. Brooks and A. W. Bartlett give a scientific account of two fungoid diseases which attack the stems or branches of gooseberry bushes. The first is due to *Botrytis cinerea*, the conidiophores of which arise from black sclerotia just outside the cylinder of woody tissue. The leaves of the branches or stems affected fall off, and the whole of the bush above the part attacked very soon dies. The authors proved by culture experiments that *Botrytis cinerea* really caused the disease.

The second case of disease is, they say, presumably due to *Cytosporina Ribis*. The dying off of the branches may occur at any time of the year; but during the winter especially, a growth of white mycelium is formed round the base of a dead tree or branch. The authors found a species of *Cytosporina* on bushes that had been killed by a fungus, but they are not yet entirely satisfied that it is parasitic.

Disease of Pine Wood.†—R. Falck has devoted great attention to diseases of timber, and the present treatise deals with the destruction of pine wood by *Lenzites*. He describes the appearance of the normal *Lenzites* species, and also the monstrosities induced by growth in darkness or in too great moisture. He distinguishes three genera, *Lenzites*, *Leucolenzites*, and *Artolenzites* (tropical), describes several new species, and gives in great detail an account of mycelium, spores, etc. Finally he discusses prevention and cure, care as to sterility of tools used in building operations, protection of timber against damage and infection, and the disinfection and impregnation of the wood by tar, etc.

Plant Diseases.‡—E. S. Salmon records the occurrence of *Rhizoctonia violacea* on the roots of seakale. The attack of the fungus was so severe that curative and preventive measures were adopted. The bed was sprayed in early spring with a solution of copper sulphate and corrosive sublimate, which reduced the disease; treatment with carbolic acid (1 oz. to 1 gallon of water) completely killed the fungus. Petroleum, formalin, and iron sulphate were also tried, but were ineffectual.

J. B. Pole Evans§ has made a special study of the mildews of the vine. *Plasmopara viticola* attacks all the green parts of the plant, but it appears first on the under side of the young leaves: the spores fall to the ground and infect the vine stock in the ground. *Uncinula spiralis* appears on the upper surface of the leaves, and by means of haustoria draws nourishment from the host.

A. Stift|| contributes an account of work and publications on the diseases of beetroot and potatoes during the year 1909, including those caused by insects, etc. (as well as by fungi and bacteria). Among fungi *Phoma Betæ* is chiefly signalled as a disease of beets. Various species of *Fusarium* and *Chrysophlyctis endobiotica* are the chief enemies of the potato. An account is given of curative methods.

* Ann. Mycol., viii. (1910) pp. 167-85 (1 pl.).

† Möller's Hauschwammuntersuchungen. Jena: Gustav Fischer, 1909, Heft. 3 pp. 1-234 (7 pls. and 24 figs.). See also Ann. Mycol., viii. (1910) pp. 257-60.

‡ Gard. Chron., ser. 3, xliv. (1908) p. 1.

§ Transv. Agric. Soc., vii. (1909) pp. 213-14. See also Centralbl. Bakt., xxvi. (1910) pp. 482-3.

|| Centralbl. Bakt., xxvi. (1910) pp. 520-60.

A. W. Borthwick* has found a new disease of *Picea*. A fungus, *Cucurbitaria Picea* sp.n., attacks the buds and hinders their growth. The lower branches suffer most from the fungus.

E. S. Salmon† writes on the *Sclerotinia* disease of the gooseberry called "die-back" in Kent. The disease may attack leaf, berry, branches, or stem. In the latter case the part of the stem first injured is on the ground level or a little above it, the stem is finally ringed by the mycelium of the fungus, and all growth stops. Salmon describes the conidial form of the fungus, a species of *Botrytis* which appears constantly on the diseased areas, and also the resting form, a sclerotium which enables the fungus to persist through severe winter weather. Prompt removal and burning of all diseased branches or bushes is urgently recommended and heavy spraying with a solution of copper sulphate.

In the same journal‡ it is stated that wart disease of potatoes (*Chrysophlyctis endobiotica*) can be checked by greening the tubers. Two reasons are given to account for this: (1) The swarm-spores avoid cells containing chlorophyll, and all the cells of autumn greened potatoes are rich in chlorophyll; and (2) the sprouts from these tubers are of slow growth, and have developed a comparatively thick cuticle and epidermis through which swarm-spores cannot penetrate.

An account§ is also given of a disease of a fig-tree somewhat resembling apple canker in outward appearance. It was found to be caused by a fungus *Libertella ulcerata*, which grows on the branches or twigs and causes them to crack. In badly affected branches all parts above the canker die. It is a wound parasite, and as a preventive all wounds or cuts should be tarred and all diseased branches burned.

The occurrence of *Chrysophlyctis endobiotica* in Ayrshire is chronicled by D. A. Boyd,|| who gives a detailed description of the disease which appeared on potatoes grown in a nursery at Saltcoats. Agriculturists are warned as to the serious nature of the disease, especially in a potato-growing district, and of the necessity of securing, for seed, tubers free from the fungus. The spores may lie dormant in the soil for four years and then reinfect the crop.

G. H. Pethybridge¶ publishes an account of various potato diseases that have come under his observation in Ireland. *Chrysophlyctis endobiotica* is practically unknown. Black blight due to *Phytophthora infestans* is all too common. Various experiments were made with spraying mixtures, the most effective being freshly made up Bordeaux mixture. Stalk or *Sclerotium* disease (*Sclerotinia sclerotiorum*) is also prevalent in West Ireland. It has not been ascertained how the attack occurs, as it is difficult to detect in the early stages, but it is certainly promoted by moist conditions due to crowding of the plants or the development of weeds. It has been of advantage to dress the soil before planting with Bordeaux mixture or with a heavy layer of lime.

Much damage is also done by Cork scab (*Spongospora subterranea*),

* Notes R. Bot. Gardens Edin., xx. (1909) pp. 259-61 (1 pl.).

† Journ. Board Agric., xvii. (1910) pp. 1-9 (8 figs.).

‡ Tom. cit., pp. 46-7.

§ Tom. cit., pp. 47-9 (1 fig.).

|| Glasgow Naturalist, i. (1909) pp. 62-5.

¶ Journ. Dept. Agric. Ireland, x. 2 (1910) 18 pp. (4 pls.).

which affects the tubers and is caused by an organism allied to finger-and-toe. Experiments have shown that if seed potatoes are treated with a solution of formalin and water, or soaked for 24 hours in 2 p.c. copper sulphate and washing soda, the resultant crop is quite healthy. Cases of leaf-curl caused by *Verticillium albo-atrum*, and black speck scab due to a *Corticium*, are also recorded. Violet root-rot fungus, *Rhizoctonia violacea*, was observed for the first time in Ireland on potatoes from Co. Mayo.

C. E. C. Fischer* has studied the disease of timber trees due to *Pestalozzia Hartigii*. It attacks the seedlings, killing the cambium all round the stem, its presence being easily recognized by a constriction at the spot. Fischer grew the spores of the fungus in water, prune-juice, and in a jelly of meat and malt extract; the spores were reproduced in from 14 to 40 days. No other form of reproductive organs were obtained during eight months' culture, and all attempts at artificial infection of living plants failed.

Flora W. Patterson† describes a new species, *Stemphylium Tritici*, which is often associated with sterile florets of wheat. Artificial inoculation resulted in 9 p.c. of sterile florets. In nature it is prevalent on the leaves and is almost invariably present in diseased ovaries.

Griffon and Manblanc‡ describes the heart-rot of beet-root, due to the fungus *Phoma tabifica*. They distinguish this malady from the rotting of the leaves caused by a *Cladosporium*; in pure cultures of *Phoma* the same pycnidial stage was always reproduced; the form of the mycelium was, however, somewhat modified in artificial cultures.

In a recently issued leaflet from the Board of Agriculture§ on strawberry cultivation, attention is called to two leaf diseases of the plants, *Sphærella Fragariæ*—which begins by forming dark brown spots, and finally killing the leaf—and *Sphærotheca Castagnei*, a mildew which appears first on the under surface of the leaves and spreads to the fruit, which it utterly destroys. The same fungus causes mildew of hops. Spraying with Bordeaux mixture is recommended in each case.

Em. Marchal|| reports the appearance in Belgium of the American gooseberry mildew. The outbreak is not due to the importation of infected plants, but probably to the visit of a traveller from Holland, whose own bushes were infected. Vigorous measures were taken to stamp out the disease, and these have been effective for the time.

Corky scab of potatoes (*Spongospora scabies*) has recently appeared in South Africa, having been imported with tubers consigned to Rhodesia and to the Transvaal for planting. J. B. Pole Evans,¶ the plant pathologist, detected the disease on the potatoes, and describes it so that growers may be able to recognize it, and to avoid planting affected tubers.

Pole Evans** also describes a disease of the lemon, caused by the fungus *Diplodia natalensis* sp. n. The fungus enters the fruit by the

* Journ. Econ. Biol., iv. 3 (1909) pp. 72-7 (1 pl.).

† Bull. Torrey Bot. Club, xxxvii. (1910) p. 205.

‡ Bull. Soc. Mycol. France, xxvi. (1910) pp. 126-31 (1 pl. and 1 fig.).

§ Board of Agriculture and Fisheries, Leaflet No. 207 (1910) 6 pp.

|| Bull. Soc. Roy. Bot. Belg., iv. (1900) pp. 337-8.

¶ Transvaal Agric. Journ., viii. (1910) pp. 462-3 (1 pl.).

** Tom. cit., pp. 463-5 (1 pl.).

stalk, and causes discoloration and decay of the tissues—hence the name “black rot.” The author strongly urges the destruction of all fallen fruit.

Ethel M. Doridge* describes a leaf-blight of pear and quince, and also of other fruit trees. It is caused by a minute fungus, *Entomosporium maculatum*. All the leaves of a tree may be attacked, and the tree thus seriously injured. Spraying with Bordeaux mixture is recommended.

G. Masee † describes a disease of coffee called “spot disease,” which is caused by *Stilbum flavitum*. Masee failed to induce the conidiospores of *Stilbum* to germinate, but on some old berries he found an ascigerous form, *Sphærostilbe flavida* sp. n., and inoculation experiments with the ascospores reproduced the *Stilbum* stage.

G. Ihssen ‡ describes the history and development of the “snow disease,” a *Fusarium* fungus that attacks various Gramineæ. Ihssen describes more particularly its effect on rye-plants. He made a series of inoculation experiments, and succeeded in identifying it with *Nectria graminicola*, of which it is the conidial stage. The perithecial fruits develop on the dead leaves, etc., of grasses.

In a series of notes on Plant Pathology, J. B. Pollock § describes a case of parasitism of *Ganoderma sessile*. It grew on maple as a wound-parasite; it did not seem to be able to attack the cambium, but it completely destroyed the exposed wood, both sap and heart-wood, so that the trunk was decayed right to the centre. Another wound-parasite, *Polystictus hirsutus*, grew on mountain ash. The diseased condition was slowly progressive, but eventually the trees were killed.

Pollock also describes a conidial form of *Sclerotinia* on *Prunus serotina*—*Monilia Seaveri*; it is a serious parasite and destroys the leaves. *Sclerotinia fructigena* is also discussed by the author and *S. aestivalis* sp. n. on mummified apples. No conidial stage of the latter was found.

G. Dorogin ¶ describes a case of disease of *Ulmus campestris*. The leaves were marked with the yellowish circular spots of *Glucosporium inconspicuum* var. *campestris* var. n. No later stage of the fungus was found.

L. Richter ¶¶ takes note of some Portuguese plant diseases reported by J. V. d'Almeida: a black disease of artichokes caused by *Ramularia*; the withering of begonia leaves due to *Phyllosticta Begoniæ*; the mildew of oaks, which has also spread to Portugal, though not yet very abundant; and a canker of chestnut trees caused by *Coryneum perniciosum*.

Vitality of Spores.**—Spores of *Mucor Mucedo*, *M. racemosus*, *Rhizopus niger*, *Sterigmatocystis nigra*, and *Aspergillus glaucus* were slowly dried during two weeks at a temperature of 35° C., and enclosed in tubes and exposed for three weeks to the temperature of liquid air and then of liquid hydrogen during 77 hours. With all care the spores were subsequently sowed on sterilized culture media and germinated in 16 hours

* Transvaal Agric. Journ., viii. (1910) pp. 465-6 (1 pl.).

† Kew Bull., viii. (1909) pp. 337-41 (1 fig.).

‡ Centralbl. Bakt., xxvii. (1910) pp. 48-66 (1 pl. and 8 figs.).

§ Eleventh Rep. Mich. Acad. Sci. Darwin Cent. Publ., 1909, pp. 48-53.

¶ Zeitschr. Pflanzentr., xx. (1910) pp. 261-2 (2 figs.).

¶¶ Tom. cit., pp. 263-4. ** Comptes Rendus, cl. (1910) pp. 1437-9.

and some of them in two days. Paul Becquerel, who records the experiments, argues on the significance of vitality. "Life," he says, "is only the physico-chemical functioning of protoplasmic organisms induced by their ceaseless connexion with the elements of matter and the different forms of energy."

Ambrosia Fungi.*—J. Beauverie has studied these fungi in connexion with the galls of various insects, and gives the results of his observations. He has come to no definite conclusions, as it is difficult to distinguish between the *Ambrosia* fungus proper and fungi that may only be impurities. A new observation he has made is the constant presence of a yeast in the galleries of the wood-beetle.

British Mycology.†—An account is given of a spring foray for the collection of fungi, organised by the British Mycological Society. The foray was held at Shrewsbury in the end of May 1909, when over 194 species were found by the members of the society. A list of the species is given. The autumn foray was held at Baslow, Derbyshire, in the end of September, and resulted in the collection of over 533 species of fungi, including ten new to Britain, and five new to science. The Mycetozoa, numbering forty species, are also enumerated.

Professor Potter chose as the subject of his presidential address, Bacteria in their relation to plant pathology. He traces the history of our knowledge of these organisms as connected with plant diseases, and describes some diseases that are due to bacteria, such as "white rot" in turnip. He draws attention to the large and varied flora of bacteria and microfungi that may be found growing on the surface of healthy leaves, and also to the soil bacteria which may sometimes penetrate the roots of plants. He does not consider that the mutual relationship between bacteria and parasitic fungi is at all clearly understood.

René Maire, who attended the foray as a representative from the French Mycological Society, gives diagnoses and descriptions of some new and interesting British Hymenomycetes found during the foray.

A. Lorrain Smith publishes a list of fungal parasites of lichens that had been generally classified in Britain as lichens; they are Pyrenomycetes belonging to the genera *Ticothecium*, *Didymosphæria*, *Pharcidlia*, *Massaria*, and *Müllerella*.

The same writer also gives a list of new or rare microfungi collected during the past year in various parts of Great Britain.

A. D. Cotton contributes a third series of notes on *Clavariæ*, with special diagnoses and notes of several species. He gives revised descriptions of *C. Kunzei*, *C. umbrinella*, *C. tenuipes*, and records a new species, *C. persimilis*.

W. B. Allen remarks on the large number of Mycetozoa collected during the autumn foray; he gives descriptive notes of the more rare and interesting forms.

René Maire contributes a weighty paper on The Bases for the Systematic Determination of Species in the Genus *Russula*. He points

* Ann. Sci. Nat., xi. (1910) pp. 31-64 (9 figs.).

† Trans. Brit. Mycol. Soc., Season 1909, iii. pt. 3 (1910) pp. 131-232 (4 pls., 3 coloured).

out the characters that he considers of systematic value, both macroscopic and microscopic, and describes the use and value of chemical reagents in the determination of allied species.

Carleton Rea deals with the larger fungi, new or rare, that have been found in Great Britain during the year.

An obituary notice of C. B. Plowright is added, one of the most noted British mycologists. He was President of the Society for the years 1898-99.

Mycorrhiza of Fruit-trees.*—Vital Boulet found endophytic mycorrhiza in a large number of fruit-trees in the natural order Rosaceæ. He describes the development and appearance of the fungus, and concludes from his observations that it is a true parasite—harmless, as a rule, because the vital parts of the root are not injured, but occasionally fatal to the roots infected. Boulet thinks that the mysterious perishing of fruit-trees may be due to the presence of the fungus in the roots.

ADE, A.—**Beiträge zur Pilzflora Bayerns.** (Contributions to the fungus flora of Bavaria.) *Mitteil. Bayer. Bot. Ges.*, ii. No. 13 (1909) pp. 217-19 (1 fig.). See also *Ann. Mycol.*, viii. (1910) p. 251.

ANDERSON, J. P.—**Iowa Erysiphaceæ.**
[A list of the fungi, with diagnoses, preceded by a general account of the order.]
Contrib. Bot. Dep. Iowa, State Coll. Agric. Mech. Arts, xiv. No. 35.
See also *Centralbl. Bakt.*, xxvi. (1910) pp. 689-90.

BAMBEKE, CH. VAN—**Sur Polystictus cinnamomeus Sacc. et P. Montagnei Fr.**
[A discussion on the similarity of the two species.]
Bull. Soc. Roy. Belg., xlvi. (1909) pp. 15-38 (1 pl.).

BATAILLE, F.—**Champignons rares ou nouveaux de la Franche-Comté.** (New or rare fungi in Franche-Comté.)
[A list of the larger fungi, with descriptions.]
Bull. Soc. Mycol. France, xxvi. (1910) pp. 133-49.

BUBAK, FR., & J. E. KABAT—**Mykologische Beiträge.** (Mycological contributions.)
[Descriptions of new species; there is one new genus, *Chatodiscula* (Excipularacearum)].
Hedwigia, l. (1910) pp. 38-46 (1 pl. and 1 fig.).

CRUCHET, D.—**Micromycetes nouveaux récoltés en Valais du 19 au 22 Juillet 1909.** (New Micromycetes collected in Valais from the 19th to the 22nd July 1909.)
[Some new species are included in the list.]
Bull. Soc. Vaud. Sci. Nat., ser. 5, xlv. (1909) pp. 469-75 (figs.).

DAVIS, J. J.—**Fourth Supplementary List of Parasitic Fungi of Wisconsin.**
[Several new species are included in the list.]
Trans. Wisconsin Acad. Sci. Arts, Lett. xvi. (1909) pp. 739-72.
See also *Ann. Mycol.*, viii. (1910) p. 251.

DOX, ARTHUR W.—**The Intercellular Enzymes of Lower Fungi, especially those of *Penicillium camemberti*.**
Journ. Biol. Chem., iv. (1909) p. 461.

JAAP, O.—**Fungi selecti exsiccati. Series xv. und xvi., Nos. 351-400.**
[The series consists of microfungi, a number of them being new species. They were collected in Priegnitz and in Schleswig-Holstein.]
See also *Bot. Centralbl.*, cxiii. (1910) pp. 396-7.

„ „ **Ein kleiner Beitrag zur Pilzflora der Eifel.**
[A list of the fungi collected by the author in August 1909.]
Ann. Mycol., viii. (1910) pp. 141-51.

* *Comptes Rendus*, cl. (1910) pp. 1190-2.

- KAUFFMAN, C. H.**—Unreported Michigan Fungi for 1908, with a Monograph of the Russulas of the State.
[A short list of fungi, and description of fifty-six species of *Russula*.]
Eleventh Rep. Mich. Acad. Sci. Darwin Cent. Publ., 1909, pp. 55-91 (3 pls.).
- LAGERHEIM, G.**—Verzeichnis von parasitischen Pilzen aus Södermanland und Bohuslän. (List of parasitic fungi from Sodermanland and Bohuslän.)
[About 118 species are recorded, two of them new to science.]
Svensk. Bot. Tidskr., iii. (1909) pp. 18-40.
See also *Centralbl. Bakt.*, xxvi. (1910) pp. 687-8.
- MALKOFF, KONSTANTIN**—Zweiter Beitrag zur Kenntnis der Pilzflora Bulgariens. (Second contribution to the knowledge of the fungus flora of Bulgaria.)
[A list of 104 species collected by the late K. Malkoff, and revised by Fr. Bubak.]
Ann. Mycol., viii. (1910) pp. 187-91.
- MIGULA, WALTER**—Kryptogamen Flora. Lief 91-3.
[These fascicles deal with *Puccinia*, *Phragmidium*, *Triphragmium*, *Gymnosporangium*, *Gymnoconia*, and *Chrysonyxa*.]
Flora von Deutschland, v. (1910) pp. 417-64 (5 pls.).
- NAMYSŁOWSKI, BOLESŁAW**—Zygorhynchus Vuillemini.
[A new Mucorine, isolated from the soil and cultivated on sterilized pears, etc.]
Ann. Mycol., viii. (1910) pp. 152-5 (9 figs.).
- PAQUE, E.**—Nouvelles Recherches pour servir à la Flore cryptogamique de la Belgique. (New researches for a Cryptogamic Flora of Belgium.)
[The list of Mycetozoa and fungi includes a variety of *Polyporus acanthoides* new to science.]
Bull. Soc. Roy. Belg., xlvi. (1910) pp. 279-95.
- PATOUILLARD, N., & V. DEMANGE**—Nouvelle Contribution à la Flore mycologique du Tonkin. (New contribution to the mycological flora of Tonkin.)
[A list of the larger fungi, including several new species.]
Bull. Soc. Mycol. France, xxvi. (1910) pp. 31-48.
- PETERSEN, H. E.**—Studir over Ferkvands-Phykomyceten. (Study of Phycomycetes in Denmark.)
Bot. Tidskr., xxix. (1909) pp. 345-440.
- VOGLINO, PIERO**—Ricerche intorno alla Sclerotinia Ocymi sp. n., parassitica del Basileo. (Research on *Sclerotinia Ocymi* sp. n., parasitic on *Ocymi basilici*.)
Atti R. Accad. Sci. Torino, xlv. (1910) pp. 441-8 (5 figs.).
- VOUVAUX**—Descriptions de nouvelles espèces de Champignons.
[Descriptions of nine new species of fungi]
Bull. Soc. Mycol. France, xxvi. (1910) pp. 153-7
- WILSON, GUY WEST**—A New European Species of Peronospora.
[A form of Papilionaceæ.]
Ann. Mycol. viii. (1910) pp. 185-7.
- ZELLNER, JULIUS**—Zur Chemie der höheren Pilze. IV. Mitteilung: Ueber Maltosen und glykosidspaltende Fermente. (Chemistry of the higher fungi. Fourth contribution: on maltose and glucoside splitting ferments.)
S.B. k. Akad. Wiss. Math.-Nat. Kl., cxviii. (1909) 2te Abt. 6, pp. 439-46.
See also *Hedwigia*, Beibl., 1. (1910) pp. 16-17.

Lichens.

(By A. LORRAIN SMITH.)

Relation between Gonidia and Hyphæ in Lichens.*—U. N. Danilov gives a résumé in German of his paper (Russian) on Lichen-gonidia. He studied species of *Evernia*, *Parmelia*, *Xanthoria*, *Ramalina*, *Usnea*, *Cladonia*, and *Lecanora*, all of them common examples of heteromercous lichens, and in all of which he found evidence of the antagonistic character of the relationship between algæ and hyphæ. He found a distinct enlargement of the hyphæ at the point of contact with the alga; either

* *Bull. Jard. Imp. Bot. St. Pétersbourg*, x. 2 (1910) pp. 33-70 (3 pls. and 9 figs.)

smaller cells were formed by repeated septation of the hypha, or short branchlets were formed. The ends of these are pear-shaped, the larger end being applied to the gonidial membrane, giving the appearance of the gonidium being cut off from the hypha, and this form evidently aids the osmotic interchange of cell-contents between hyphæ and gonidia. At the point of contact the hypha puts forth short processes or haustoria, which pierce the membrane of the gonidium and branch within the cell, forming a network of delicate hyphæ over the cell-contents; secondary haustoria then penetrate the protoplasm and rob the cell. The author noted swellings in the hyphæ of the network, which may be due to over-supply of nourishment or may represent some stage in the development of the fungus not properly understood. In addition he found within the gonidium well-developed hyphæ which gradually fill it and after its final destruction grow out and attack other gonidia.

Danilov states that the gonidia become deformed and finally die, and as a proof of this he adduces the presence of gonidia in the thallus with shrivelled protoplasm of irregular form, which gradually disappears, giving place to hyphæ, the presence of colourless gonidia in the thallus filled with the hyphal network, and the presence of empty gonidial membranes. Still further evidence he finds in the increased division of gonidia that have been attacked, the daughter-cells in turn becoming invaded by the hyphæ. He concludes that there is no doubt as to the parasitism of the hyphæ upon the algæ, and he also hazards the theory that possibly the gonidia that finally become free contain within them some "mycoplasma" or protoplasmic pro-embryo that may develop later into hyphæ.

Lichens of Aragon.*—P. Longinos Navas describes the structure of thallus and apothecia of lichens, and gives instructions as to the best methods of collecting and preserving the different kinds. He advises the use of reagents, and gives the quantities and properties of those that should be employed. In the systematic part of his paper he deals with the genera *Lobaria*, *Ricasolia*, and *Sticta*.

Lecidea mougeotioides Schaer. in Britain.†—E. N. Bloomfield communicates the substance of a letter received so long ago as 1879 from C. Lorbalestier, in which the latter identified a lichen sent to him by E. N. Bloomfield from Fairlight Undercliff, near Hastings. The lichen, which is found chiefly in mountainous localities in Central and South Europe, has been determined as synonymous with *Rinodina oreina* Wain. It is a conspicuous plant, with a somewhat lemon-yellow thallus, variegated with black and with a distinct border. The lichen has not been recorded since its first gathering in December 1877.

CUFINO, LUIGI—Species Cryptogamarum a cl. Prof. F. Gallina in *Erythræa collectæ*. (Cryptogamic species collected in *Erythræa* by Prof. F. Gallina.)

[A number of lichens are included in the list.]

Malpighia, xxiii. (1909) pp. 245-6.

HASSE, H. E.—Additions to the Lichen-flora of Southern California.

[Five species have been added, two of them new to science.]

Bryologist, xiii. (1910) pp. 60-2.

* Bol. Soc. Arag. Cienc. Nat., ix. (1910) pp. 34-45 (9 figs.).

† Journ. Bot., xlviii. (1910) p. 141.

JATTA, A.—**Lichenes, i., Part iii.**

[The part just issued includes the Lecanoreæ and Pertusariææ.]
Flora Italica Cryptogama, Rocca S. Casciano, 1910, pp. 265-460.

” ” **Licheni dell' Asmara.**

[Lichens collected at Asmara by N. Beccari and others. A number of new species are included in the list of seventy-seven species.]
Nuovo Giorn. Bot., Ital., xvii. (1910) pp. 192-206 (1 pl.).

KEISSLER, KARL V.—**Einige bemerkenswerte Flechtenparasiten aus dem Pinzgau, in Salzburg.** (Some noteworthy lichen parasites from Pinzgau, in Salzburg.)

[Descriptions of several microfungi.]
Oesterr. Bot. Zeitschr., lx. (1910) pp. 55-61.

STEINER, J.—**Lichenes Persici coll. a cl. Consule Th. Strauss.** (Persian lichens, collected by Consul Th. Strauss.)

[A number of the species are new.] *Ann. Mycol.*, viii. (1910) pp. 212-45.

Mycetozoa.

(By A. LORRAIN SMITH.)

Myxomycetes of Brandenburg.*—O. Jaap has collected ninety species of Myxomycetes at Triglitz in Prignitz; a large number for so small a district, including some very rare species. The author gives with the lists the corresponding numbers of his exsiccati and critical notes on their form or distribution.

Plasmodiophora Brassicæ.†—Ernest F. L. Marchand writes that this organism, so well known as a parasite of Cruciferae, also attacks Cucurbitaceæ, Umbelliferae, and Polygonaceæ. Marchand has verified the occurrence of the parasite on plants of these orders, and draws attention to the risks of cultivating plants on infected soil. The only method of defence is to try and destroy the spores in the soil.

Schizophyta.

Schizomycetes.

Electricity and Micro-organisms.‡—G. E. Stone has investigated the effects produced by electricity upon various micro-organisms. The author finds that currents of 0·1 to 0·3 milliampere act as stimuli in the production of bacteria in water. Similar results were obtained in the case of milk, but the increase was greater owing to the better food-supply for the bacteria. Milk was also subjected to positive and negative charges of static electricity, and in this case it was found that the growth of bacteria was inhibited, the most pronounced results being obtained with the negative charges. Experiments upon the bacteria in soils show that both static and galvanic electricity favour the growth of soil-bacteria. Yeast gives off a larger amount of CO₂ when treated with either static or galvanic electricity, the results obtained being more pronounced with low temperatures than with high temperatures.

The effects of electrical stimuli are seen soon after application and

* Abhandl. bot. Ver. Prov. Brandenburg, li. (1909) pp. 59-68. See also Bot. Centralbl., cxiii. (1910) p. 468.

† Comptes Rendus, cl. (1910) pp. 1349-50.

‡ Bot. Gaz., xlviii. (1909) pp. 359-79 (2 figs.).

increase until a certain optimum is reached. The effects are dependent both upon the intensity and the duration of the stimulus. The manner in which the stimuli act cannot be explained, but no doubt the protoplasm is affected, with the result that metabolic processes become more active.

Investigations on Disinfection.*—C. Eijkman has experimented with *Bacillus coli communis* under the influence of phenol. Previous experiments made by this writer not being in agreement with those of other investigators, the present experiments were made with the object of discovering the causes of variation. The variations were seen in the differing resistance against high temperatures shown by bacteria of the same culture. A previous investigator has attributed this variation to difference in age of the individuals of the same culture. The present experiments were made in solutions of phenol of concentration of 0.5 p.c. to 1 p.c., and everything possible was done to insure that the individuals were all in the same stage of disinfection and of the same age. In spite of this, considerable differences of resistance between individuals was again evident. The author suggests that it is possible "that the power of resistance during the development between two successive divisions undergoes changes." Thus a daughter-cell, just formed and having a relatively larger surface, may have less resistance than a full-grown cell.

Metachromatic Granules in Acid-fast Bacilli.†—In young bacilli, V. Babes finds that by the Ziehl-Neelsen method these granules are not differentiated. By means of an iodised safranin stain, however, the metachromatic granules are clearly seen, especially in the case of the lepra bacillus. The author uses a combined Ziehl-Gram-Weigert method, by means of which the granules are stained blue, and the remainder of the bacillus red. The contrast is better marked in older cultures. In old cultures and in foci of long standing, it is possible to find all transitional stages between bacilli and free granules. Also, in some living cultures, and in some still-virulent foci, granules alone are found. This leads to the conclusion that these granules are the most resistant portions of the bacilli.

New Bacillus of the Hæmorrhagic Septicæmia Group.‡—During a recent very fatal epizootic among cats in Bohemia, Z. Bouček had the opportunity of examining the bodies of four animals which had died of the disease. Post-mortem examination revealed a condition of hæmorrhagic septicæmia and enteritis. From the blood and from various organs, he obtained a small oval, non-motile, non-sporing, Gram-negative bacillus, which showed well-marked polar staining. This organism grew readily upon ordinary media, and inoculations of pure culture proved fatal to kittens and mice. By means of giving a kitten protective inoculations of the bacillus of rabbit septicæmia, it was found that immunity against this organism of cat septicæmia was produced; so that the two types of organism must be closely allied.

Tuberculosis in Salt-water Fish.§—L. von Betegh gives a preliminary note of his work on this subject. Up to the present, there is

* Proc. Sect. Sci. k. Akad. Wetensch. Amsterdam, xi. (1909) pp. 668-74.

† C.R. Soc. Biol. Paris, lxxviii. (1910) pp. 315-18.

‡ Centralbl. Bakt., 1^{te} Abt. Orig., liii. (1910) pp. 279-93.

§ Tom. cit., pp. 374-7.

no record of tubercle occurring naturally in salt-water fish. From a pure culture of a virulent strain of the *B. tuberculosis* of fresh-water fish, the author prepared an emulsion, and with this inoculated a number of fish belonging principally to the genera *Sparus* and *Serranus*. Of these, two died: the first 1 month, the second 7 months, after injection. In the latter he found tuberculosis of the swimming-bladder, in the former the disease was almost entirely confined to the site of inoculation. Thus, in neither case was there generalised tuberculosis. Experiments with human and avian tubercle are still in progress.

Scientific Cheesemaking.*—Under the title of *Technique fromagère*, P. Mazé considers the theoretical basis of the scientific manufacture of cheese, and the practical application of principles so established. Cheese is defined as consisting merely of the insoluble extract of milk, somewhat altered, and deprived, as completely as possible, of milk sugar. For this purpose it is undesirable to obtain complete solution of casein. It is thus necessary, in the first place, to prevent the interference of peptonising ferments, and secondly, to secure the operation of useful ferments which act upon the milk sugar, but do not attack nitrogenous matter or fat. This is effected by getting the proper balance between antagonistic microbial ferments.

The fermenting organisms fall into three classes: the lactic ferments, the ferments of combustion, and the alkaline ferments. The conventional standard of efficiency for the first class of organisms is that they should produce 12 gm. of lactic acid per litre of milk. The acidifying power is directly in proportion to the power of multiplication. Many bacteria which produce lactic acid are unsuitable because they also give rise to acetic acid, and this except in the merest traces is undesirable. The morphological characters of this class vary, especially in the size of the individuals; as ovoid cocco-bacilli, single or paired, they are found in milk; in chains, they may appear in broth, but in milk this appearance indicates an undesirable type of fermenter. The characters of colonies upon solid media afford an important means of distinguishing different species. All lactic fermenters produce a certain degree of solution of casein in an acid medium. If the clot becomes alkaline, this solution proceeds further. It is undesirable that this action should advance to a further break-up of nitrogenous material, for the products of such action would impart a disagreeable flavour to the cheese.

A growth of mould appears upon the surface of the material after two days. These moulds produce combustion ferments which destroy milk sugar and lactic acid, thus arresting the activity of the lactic ferments. The cheese becomes alkaline and solution of casein begins. These moulds consist of various species of *Oidium*, *Mycoderma*, and *Penicillium*. *Penicillium* is the most active in the attack upon sugar, but *Oidium* (particularly *Oidium camemberti*) is most desirable in that it spares casein.

The alkaline ferments are produced by certain small non-motile aerobic bacilli, the "ferments de rouge." These complete the destruction of sugar and attack the lower nitrogenous products. There are a great number of species of these organisms, possessing different degrees of

* Ann. Inst. Pasteur, xxiv. (1910) pp. 395-428.

resistance to acidity. The most highly resistant are the first to appear. Their presence is indicated by the appearance of a red colour on the surface of the cheese.

The author selects certain members of each class as being most suitable for performing the several functions of these organisms, and states that by the scientific selection of these agents, constant results may be obtained.

The remainder of the paper is devoted to a review of the technical details of the processes of coagulation, pressing, and drying. The process of pressing out the whey ("égouttage") is one of the greatest importance, and is considered in detail. Of equal importance are the measures by means of which the correct degree of moisture is secured by means of drying, salting, and so on. The influence of temperature, acidity, and rennet ferment is considered, and constants for these factors are quoted, with detailed comments upon their range of applicability.

Cultivation of Mould from Rancid Butter.*—From a specimen of rancid butter, permeated with mould, H. Kühn made cultivations upon potato and bread, and in a sterile solution of honey. Upon the solid media, circular white mycelial growth appeared in 24 hours, and the colonies developed green centres after 2 days. In the honey medium; growth took place more slowly. The organism was identified as *Penicillium glaucum* Link. The fat-splitting power of this mould was observed in 1897 by Camus, who succeeded in extracting a small quantity of a saponifying enzyme.

Bacterial Disease of Potatoes.†—A. Spieckermann gives a preliminary account of a disease of the vascular bundles of potato plants, due to bacterial invasion. Infection occurs usually through a wound in the stalk. The disease is manifested first by rolling up of the leaves, and leads to the death of the plant. The tubers are infected early, attain only an imperfect stage of development, and die. By artificial inoculation of the organism isolated, the author has succeeded in reproducing the disease in many varieties of potato. The organism is a very short bacillus, not provided with flagella, which grows very slowly upon artificial media. Upon gelatin, small whitish colonies become visible after 8 days; the medium is not liquefied. Sugar media undergo no fermentation. Milk is slowly coagulated. The bacilli are Gram-positive. Spore-formation has not been observed.

For purposes of comparison, an account is given of the bacterial potato disease described by Appel. The causal organism is a *Pseudomonas* which invades the vascular system, and causes pigmentary necrotic changes in the plant.

Bacterial Rot in Turnips.‡—T. Johnson gives an account of certain diseases in Brassicas, due to bacterial invasion. Brown rot of swede turnips is caused by the *Pseudomonas campestris* Smith, a short rod-shaped organism with one polar flagellum. It liquefies gelatin, produces a whitish growth on agar after five days, and a cream-coloured growth on boiled potato after four days. The disease is first manifested by the

* Centralbl. Bakt., 2te Abt., xxvii. (1910) pp. 167-9. † Tom. cit., pp. 205-8.

‡ Economic Proc. Roy. Dublin Soc., ii. (1910) pp. 1-7.

appearance of brownish spots in the centre of the turnip, but in advanced cases, the flesh of the turnip becomes quite black, only the rind being left in its natural condition. Soft white rot is a more rapid disease, and converts the whole turnip into a soft yellowish evil-smelling pulp. This disease is caused by the *P. destructans*. Potter, who discovered the organism, found that in white rot, an enzyme and a toxin were produced. The former destroys the cell-walls of the plant, the latter is fatal to the protoplasm. The enzyme is destroyed by boiling, which does not affect the toxin. Application of this toxin to a diseased surface arrests the disease by killing the bacteria. Soft black rot of cabbages is due to the *Bacillus oleraceæ* Harrison. These bacteria are short and may occur singly, in pairs, or in chains. They are motile and liquefy gelatin. This organism differs only from the *Pseudomonas destructans* Potter in possessing a number of peritrichous cilia, whereas the latter is possessed only of a single polar flagellum.

New Species of Thermophilic Bacilli.*—P. Georgevitch gives an account of two new species obtained in hot springs at Vranje in Servia. *Bacillus thermophilus* Yivoïni is a short stout rod, which may occur singly or in short chains. These organisms are at first motile, but lose their power when granule-formation, preliminary to spore-formation, takes place. These acid-fast granules appear also in the protoplasm, before fission occurs. The bacillus grows upon ordinary media, the optimum temperature being 43° C. Growth ceases at 50° C. A detailed account of cell-division, spore-formation, and spore-germination is given. *B. thermophilus* Losanitchi, from the sulphur springs at Vranje, grows well upon agar to which a small quantity of a sulphur compound had been added. It grows less freely upon ordinary media. Growth takes place only between 45° and 78° C., the optimum point being 72 to 73° C. Spores are formed in cultivation at 51° C., but developed in the greatest numbers at the optimum temperature. This organism is a short bacillus smaller than the foregoing, motile, and Gram-positive. Both organisms are strict aerobes.

Acid-fast and Granular Types of Tubercle Bacilli.†—Wehrli and Knoll found in their investigations that a certain number of tubercle bacilli were stained both by the Ziehl-Neelsen and by Much's modification of Gram's method. A small number, however, could only be demonstrated by the Ziehl-Neelsen process, while, on the other hand, about 50 p.c. of the bacilli were not acid-fast, but retained the stain with the Gram-Much method. From this investigation it appears that the older methods are insufficient for the identification of the tubercle bacillus.

P. Wolff obtained somewhat similar results in his examination of smears from the mesenteric glands of twenty-one children. In three out of fifteen cases which afforded no clinical or histological evidences of tuberculosis, he obtained Much's variety of bacillus. A guinea-pig inoculated from a mesenteric gland of one of these cases yielded after four weeks the typical acid-fast tubercle bacillus. Two of these three children had given a negative v. Pirquet reaction.

S. Rosenblat, in an investigation of sputum from eighty phthical

* Centralbl. Bakt., 2te Abt., xxvii. (1910) pp. 150-167.

† Op. cit., 1te Abt. Ref., xlvi. (1910) pp. 397-8.

cases, found that the relative preponderance of the types varied inversely. In some cases the acid-fast, in others the granular form was predominant. The two last-named authors agree in regarding the granular bacillus as a degenerate form possessing a low degree of virulence, and in thinking that, under favourable conditions, it is capable of acquiring anew the acid-resisting capsule and thus returning to the Ziehl-Neelsen type.

New Type of Tubercle Bacillus.*—C. Spengler describes a new variety of tubercle bacillus, to which he gives the name of *humano longus*. It occurs principally in severe cases of phthisis, more particularly in patients from the East. It grows feebly upon glycerin serum and glycerin agar, but upon a somatose-pepton-glycerin-agar medium colonies appear in from two to six weeks. It is longer and thicker than Koch's bacillus. It forms spores which can be stained by Gram's method. It possesses a relatively high degree of pathogenicity to men and animals.

Tuberculosis in Cold-blooded Animals.†—E. Bertarelli and G. Bocchia, after a brief recapitulation of the investigations upon this subject hitherto recorded, give a preliminary note of their own work. They examined a very considerable number of fishes, amphibia, and reptiles, but, except in one doubtful case, found no tuberculous lesions: so that they conclude that tuberculosis does not occur naturally in these animals. Experimental inoculation of emulsions of tubercle bacilli into lizards and frogs were made, but in only two cases were tuberculous lesions found. One lizard died six weeks after intraperitoneal inoculation, and tuberculous lymphatic glands were found. In the second place, a frog was killed four months after inoculation into a dorsal lymph space, and clumps of acid-fast bacilli were found in the liver.

A number of gold-fish received intraperitoneal inoculations of avian, bovine, and human tubercle bacilli. The fish were killed four months later, and acid-fast bacilli were recovered from the liver and other organs. The tissues did not appear to have reacted against the invasion, and no typical tuberculous lesions were found.

Streptococcus mucosus.‡—L. Arzt isolated organisms of this type from cases of cervical abscess, panophthalmitis and meningitis, and has made careful investigations of their morphology, cultural characters and pathogenicity. It is a Gram-positive organism, and may appear in chains of six to twelve individuals or in pairs, assuming reniform or lanceolate shapes. By means of Giemsa's stain, thionin-blue and other methods, a capsule can be demonstrated, and in the streptococcal type, this capsule is common to the whole chain of individuals. Little or no growth takes place upon ordinary agar, but upon serum-agar slimy colonies appear. No growth occurs in milk, unless ascitic fluid be added; in this medium even after six weeks no coagulation occurs.

In spite of some slight differences, such as the character of growth in milk, this organism must be considered identical with the *Streptococcus mucosus* of Scholtmüller. This class is intermediate between the streptococci and the pneumococci, but the possession of a capsule as well as certain cultural reactions indicate a greater affinity to the latter class.

* Centralbl. Bakt., 1te Abt. Ref., xlvii. (1910) p. 401.

† Op. cit., 1te Abt. Orig., liv. pp. 385-93.

‡ Tom. cit., pp. 394-411.

MICROSCOPY.

A. Instruments, Accessories, &c.*

(1) Stands.

F. E. Wright's New Petrographic Microscope.†—In the design of this instrument the author adopted the Zeiss No. 1 C as his base. This particular model was chosen chiefly because of its wide upper barrel,

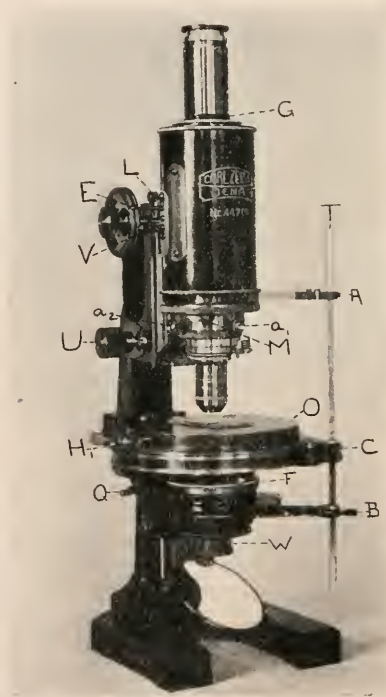

FIG. 53.

which was well adapted for the introduction of diaphragms and the movable Bertrand lens. The general view of the new Microscope is

* This subdivision contains (1) Stands; (2) Eye-pieces and Objectives; (3) Illuminating and other Apparatus; (4) Photomicrography; (5) Microscopical Optics and Manipulation; (6) Miscellaneous.

† Amer. Journ. Sci., xxix. (1910) pp. 407-14 (5 figs.).

shown in fig. 53, fig. 54 being a cross section. The chief changes which have been introduced are as follows.

1. The nicols are revolvable simultaneously about the optic axis of the Microscope. They are connected rigidly by the bar T, and their angle of revolution can be read off directly by the stage-vernier. This method obviates the errors introduced by the usual system of gear-wheels, with accompanying lost motion in the moving parts. The details of construc-

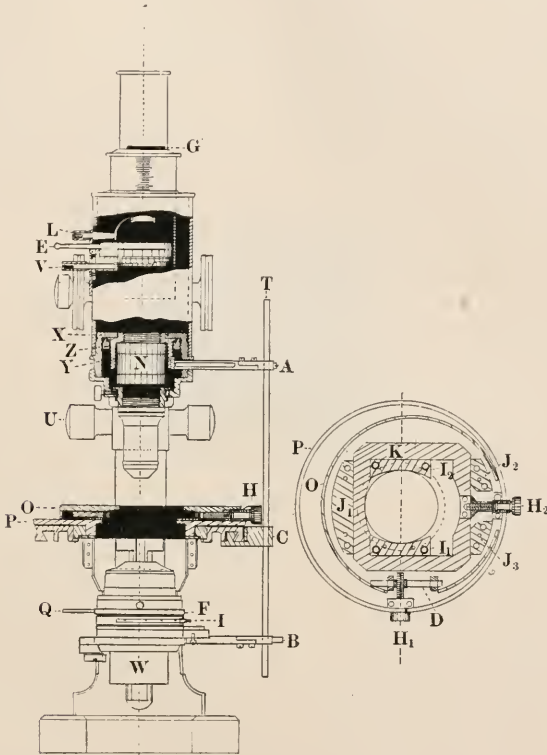

FIG. 54.

FIG. 55.

tion are shown in fig. 54. By means of the screw and cross bar at B the connecting rod T can be instantly released, and the lower nicol withdrawn or revolved by itself independently of the upper nicol. The total angle through which both nicols can be revolved by this device is 190° . [The author afterwards learned that the device of a connecting rod was not altogether new, having been used by Dick over thirty years ago, but was applied only to the revolution of a cap nicol above the ocular in conjunction with the polariser.]

2. A mechanical stage of new design (fig. 55), practically dust-proof

and mechanically simple in construction. In the figure the vertical edge or rim of the cap O of the stage-plate is indicated by the shaded broken circle, the upper surface of this plate being considered removed, and the working parts as seen from above thus exposed to view. The small plates I_1 and I_2 are attached to the lower stage, and are so constructed that the wedge-shaped edges allow the rectangular plate K to move only in an east-west direction. This movement is effected by means of the screw H_2 . The plates J_1 , J_2 , and J_3 of fig. 55, on the other hand, are attached to the upper movable plate O, and their wedge-shaped edges are so adjusted that they allow the upper plate to move only in a north-south direction with reference to the rectangular piece K. The screw H, which terminates in a block attached to the upper plate, and running in a sliding-pin D, accomplishes these north-south movements. The heads of both screws H_1 and H_2 have divisions reading to 0.01 mm. movement. Springs, not indicated in the figure, have been introduced, and oppose the forward motion of the screws H_1 and H_2 , and thus obviate errors due to lost motion in the screws. The total movement of the stage-plate in any direction is 24 mm. Mechanically, it is of simple construction, and consists of few parts.

3. The metal part, containing iris-diaphragm and polarizer, can be withdrawn from the optic axis of the Microscope by means of a release spring, not shown in fig. 54. This part is also revolvable by itself about the axis. This arrangement was adopted in preference to the usual method of inserting and withdrawing the upper nicol, because of the disturbing effect which the introduction of the upper nicol causes, both on the focus and position of the field. With the present disposition, the upper nicol remains permanently in the upper tube, and the optical system—objective, nicol, and ocular—is not disturbed in passing from ordinary to polarized light. In certain Microscopes the effect of the upper nicol on change of focus is compensated by means of a small lens of weak magnification, but even after the introduction of this device some shifting of the field may still be experienced on inserting the upper nicol.

4. An Abbe condenser is used, and with it a large nicol prism, or an Ahrens prism, 15-mm. edge, after the manner of the Fuess Microscope No. 1A. With this arrangement the entire condenser-lens system remains in position, and its upper lens need not be removed when low-power objectives are used. This does away with the devices which have been employed for throwing the upper part of the condenser combination out of the axis of the optic system, and which complicated the construction considerably.

5. The selenite or quartz plate of sensitive tint is inserted in a metal case at Q (fig. 54), just below the condenser. It is revolvable on the carriage F about the optic axis of the Microscope, an arrangement which often facilitates the determination of the ellipsoidal axis of a particular section, because the abrupt rise or fall of interference colours on insertion and rapid revolution of the plate appears more clearly than if the slower moving stage itself were revolved. At M a combination wedge is introduced as in ordinary Microscopes.

6. The Bertrand lens E, fig. 54, is mounted on a sliding arrangement

which, in connection with the sliding ocular tube, permits of different magnifications of the interference figure, an arrangement already adopted on several well-known Microscopes. In the present Microscope the focal length of the Bertrand lens (55 mm.) has been so calculated that the initial magnification of the interference figures can be varied from 0.81 to 1.90 diameters. The ocular itself magnifies this image in turn eight-fold, so that the resulting magnifications range from above 6.5 to 15.2 diameters. The fact that the upper nicol intervenes between the objective and Bertrand lens limits very considerably the range of magnification possible by the Bertrand lens. An iris-diaphragm is introduced directly below the Bertrand lens, and slides up and down simultaneously with it. This diaphragm is opened and closed by means of the pin *V* (fig. 54), which is connected with the diaphragm itself by means of pin-and-ratchet movement.

7. A second iris-diaphragm is introduced at *G* (fig. 53), directly below the ocular, and is used in connection with the observation of inter-

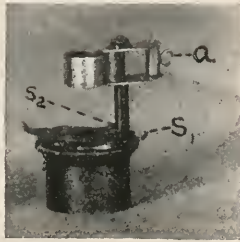

FIG. 56.

ference figures by the Lasaulx method without the Bertrand lens. To be of service in this connexion, the iris-diaphragm should be located precisely in the image-plane from the objective, as was emphasized especially by Czapski in 1891, for in that plane alone can light be excluded from adjacent minerals in the thin section. To realize satisfactorily this condition, the author has heretofore used the cap and stop indicated by fig. 56, with the two sets of slides, S_1 and S_2 , at right angles to each other. This cap fits the Microscope tube, and is inserted in place of the ocular. By means of the lens *a* the field is focused in the plane of the slides and any portion singled out for examination. Because of diffraction phenomena the aperture should not be made less than 0.5 mm. in diameter, but even with this restriction, and with the ordinary objectives, 3 or 4 mm. focal length, grains not over 0.01 mm. furnish good interference figures which ordinarily would be completely overshadowed and not discernible if adjacent light were not excluded.

Experience has shown that the effects are still clearly recognizable if the diaphragm is at a distance of not over 5 cm. from the eye, and for convenience sake, therefore, this diaphragm was inserted just below the ocular. The usual round disks with small aperture supplied with Microscopes serve the same purpose, but are less convenient.

Before stopping-down the field by the diaphragm V just below the Bertrand lens, the image-plane from the objective should, on the same principle, be brought to coincide with the plane of this diaphragm, and the desired mineral section isolated by shutting off light from the adjacent grains. To accomplish this readily, a small lens L (fig. 54), 19 mm. focal length, has been introduced in the present Microscope above the Bertrand lens, and, in conjunction with the ocular, serves the purpose of bringing to sharp focus the image-picture in the plane of the Bertrand lens iris-diaphragm, in accord with the principle noted above. In place of this small auxiliary lens, the author has heretofore used a lens of long focal length, and has viewed the Bertrand lens diaphragm directly from the top of the tube. The new arrangement is more convenient, however, and obviates the necessity of removing the ocular before viewing the interference figure. The lens L swings on an axis, and can be instantly thrown out of the field. A small spring with pointer automatically indicates the correct position of the lens when thrown into the field. The Bertrand lens diaphragm ordinarily supplied with Microscopes is of little value in the observation of interference figures by the Lasaulx method without the use of the Bertrand lens, chiefly because of the disturbing effects of diffraction from the small apertures required and the distance of the aperture from the eye of the observer.

Watson and Sons' "Advanced" Petrological Microscope.*—

The general design of this instrument is that of the Van Heurck model (fig. 57). It is mounted on a similar type of tripod foot, having a spread of $8\frac{1}{2}$ in., and is fitted with rack-and-pinion coarse-adjustment and standard lever fine-adjustment. The stage has a diameter of $4\frac{5}{8}$ in. It is fitted with a sliding bar and centring screws. The edge is divided on a silvered surface to degrees reading by a vernier to one minute. A mechanical stage may be supplied to fit on to the surface of the ordinary rotating stage if desired. The body is of large diameter, 2 in., and is fitted with a rackwork draw-tube divided to millimetres; the lower end has the universal objective thread, so that a low-power Bertrand lens may be inserted for the examination of large crystals, etc. The draw-tube is slotted to receive a Bertrand lens immediately beneath the eye-piece, and the outer body has a suitable corresponding slot to give latitude for adjustment, the actual focusing being done by means of the rackwork draw-tube. At the lower end of the body a large field analyser is fitted, which can be rotated 90° , the rotation reading against a divided scale. Beneath this is a slot to carry a quartz plate or quartz wedge. A quartz plate is included with the instrument. The eye-piece and analyser prism are combined, the latter having a large field and rotating with a reader against a circle divided to degrees. The eye-piece is slotted and has cross webs. The polariser fits into the substage of standard size, and has an extra large prism, the circle by which it is rotated being divided on a silvered edge, and each quarter circle indicated by a spring catch.

Mounted above the polarizer, but detachable from it at will, is the "lever" high-angle condenser system, either or both of whose lenses can be turned out of the field or brought into position without touching

* Catalogue, 1910-11, pp. 74-5 (2 figs.).

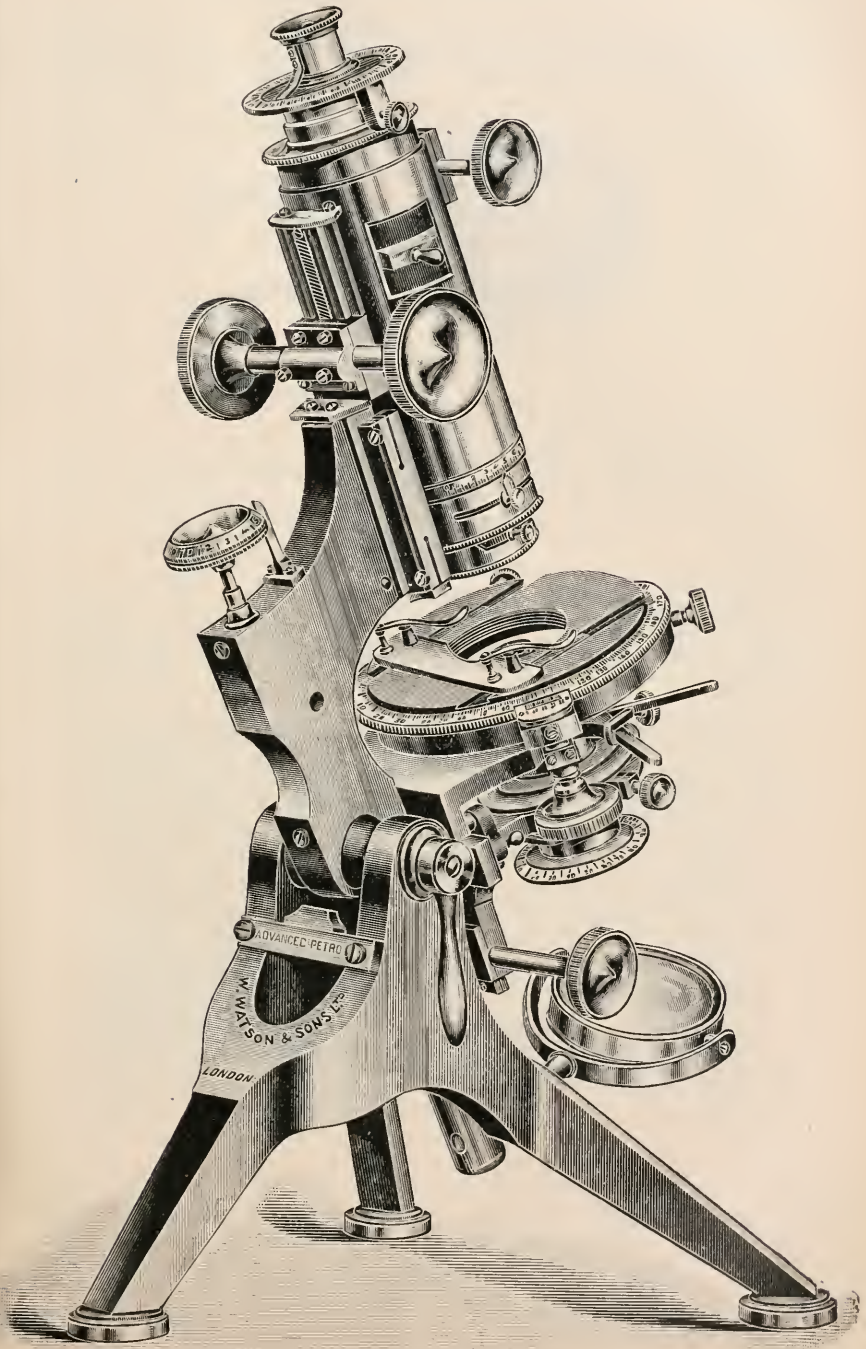

FIG. 57.

the polarizer in any way, as illustrated (fig. 58). It is probably the simplest and most effective arrangement yet devised. The substage is fitted with centring screws, and the whole of the substage apparatus can

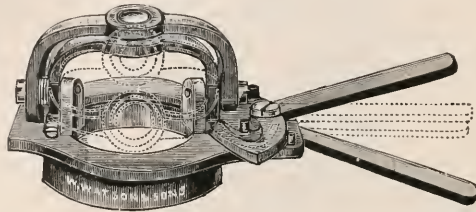

FIG. 58.

be used for ordinary microscopical purposes. It can also be turned out of the optical axis with the apparatus in it.

NACHET—*Microscope pour déterminer les taches de sang, visibles ou invisibles, récentes ou anciennes, sur un corps opaque.*
C.R. Assoc. Anat., 10^{me} réunion, Marseilles, 1908, pp. 201-3.

(2) Eye-pieces and Objectives.

F. E. Wright's New Petrographic Ocular.*—F. E. Wright has designed this ocular for use with the petrographic Microscope, and its purpose is to obtain actual numerical measurement of cleavage angles. ex-

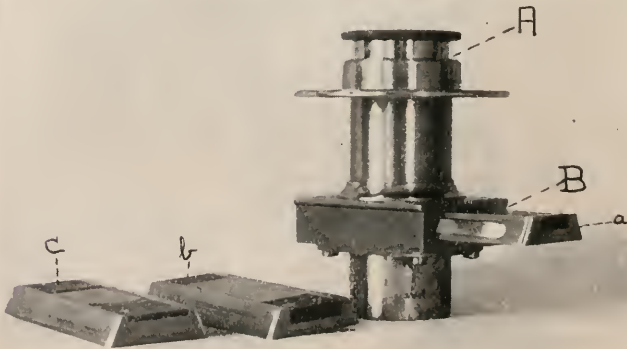

FIG. 59.

tingtion angles, optical axial angles, refractive indices, and bi-refringence. In ordinary circumstances these properties are frequently observed, owing to cumbersome methods, in only a very approximate manner. The

* Amer. Journ. Sci., xxix. (1910) pp. 415-26. (12 figs.).

author finds that his ocular successfully determines all the above properties of a thin section. The apparatus is represented in fig. 59, and consists essentially of a metal holder, which is inserted in the Microscopetube in place of the ordinary ocular, and into which in turn a positive Ramsden ocular is introduced at A, and certain plates mounted in metal carriages, *a*, *b*, *c*, are inserted at B. Cross hairs are attached to the base of the tube A, and are practically in the same plane with the upper

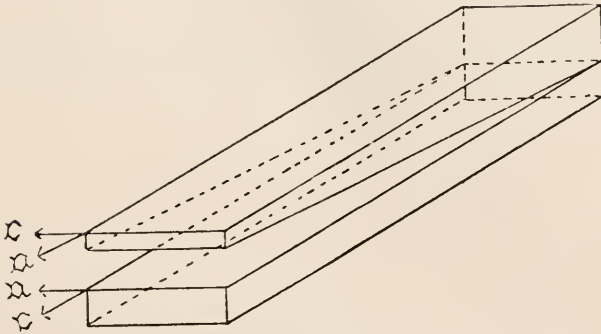

FIG. 60.

surfaces of the sliding plates, *a*, *b*, *c*, with the result that on focusing the Ramsden ocular on the cross-hairs, the divisions marked on the plates, *a*, *b*, *c*, are also in focus, and their relative movements can be read off directly. With the above arrangement the optical constants required can be measured directly by means of the three plates.

Plate *a* (figs. 60, 61) is for measurement of birefringence, and is a combination quartz wedge 35·3 mm. long, and 10 mm. wide. It con-



FIG. 61.

sists (1) of a quartz wedge cut parallel with the principal axis (direction of elongation = *c*) 0·5 mm. thick at the thin end, and 0·89 mm. at the thick end, its pitch being, therefore, about 6° 16'; and (2) of a quartz plate with direction of elongation *a* of same length and width, and 0·56 mm. thick. If these dimensions be followed exactly, $\frac{1}{10}$ mm. divisions ruled on the upper surface of the wedge (fig. 61) will give directly the difference in distance in $\mu\mu$ between emergent light waves at a particular point. Thus, for sodium light the distance between successive interference bands will be 5·89 mm. The zero line of the scale must coincide precisely with the black line of exact compensation between wedge and superimposed plate. In the present wedge this is

the case; the slope of the wedge, however, is not exactly correct, and a slight correction must be applied to the readings obtained, since 22 mm. on the wedge is equivalent to $22.62 \mu\mu$. For interference colours of the first and second order this error (nearly 3 p.c.) is very slight and can practically be neglected; but for higher orders it must be taken into account and the readings multiplied by a factor of proportion. In determining the birefringences ($\gamma - a$), or ($\gamma - \beta$, or $\beta - a$) of a mineral, the position of the mineral plate (under examination) is ascertained by means of convergent polarized light. In actual work it is not always easy to find a plate cut precisely normal either to the optic normal or to one of the bisectrices, and it is of interest to know the percentage error caused by using sections inclined at low angles with the correct directions.

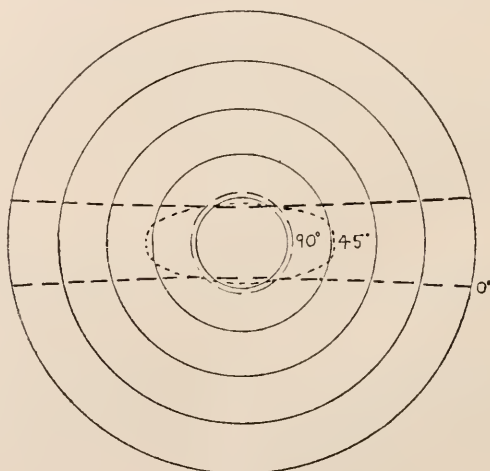

FIG. 62.

For a given plate the birefringence can be calculated approximately from the usual formula

$$(\gamma' - a') (\gamma - a) = \sin I' \sin I,$$

in which I and I' are the angles which the normal to the plate makes with the two optic axes (or optic binormals) respectively. In figs. 62-67 these relations are shown graphically in stereographic projection. In each figure the angular distance between any two successive concentric circles is 10° . In fig. 62 the positions of the directions in a biaxial crystal whose birefringence ($\gamma' - a'$) is 2 p.c. less than that of the optic normal ($\gamma - a$), are indicated for the optic axial angles $2\nu = 0^\circ, 45^\circ$, and 90° . The optic normal coincides with the central point of the figure. Fig. 63 shows positions of the directions for which the birefringence ($\gamma' - a'$) is 5 p.c. less than that of the optic normal ($\gamma - a$) which coincides with the centre of the concentric 10° circles. These curves are drawn corresponding to the optic axial angles $2\nu = 0^\circ, 45^\circ$, and 90° .

Fig. 64 is like fig. 63, except that the directions are indicated whose birefringence is 10 p.c. less than that of the optic normal located at the

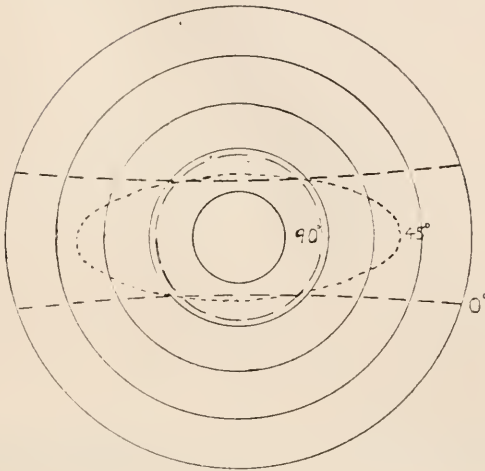

FIG. 63.

centre of the projection plate. The positions of the curves corresponding to optic axial angles $2\nu = 0^\circ, 15^\circ, 45^\circ, 60^\circ, 75^\circ, 90^\circ$ are indicated in the

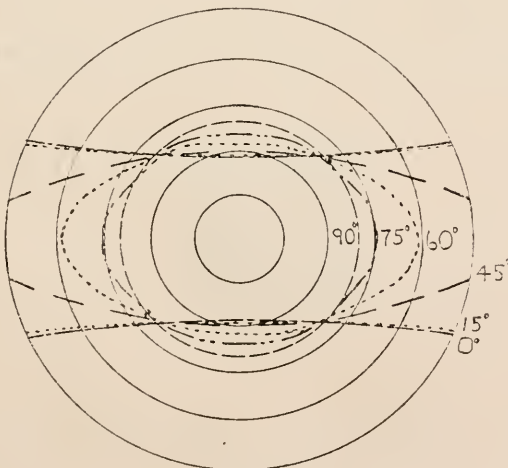

FIG. 64.

figure. In fig. 65 the directions, whose birefringence is 10 p.c. less or greater than that of the acute bisectrix (optic axial angle $2\nu = 45^\circ$), are

shown by the dotted curves. In this figure the dotted curve which passes through the centre point (acute bisectrix) marks the directions

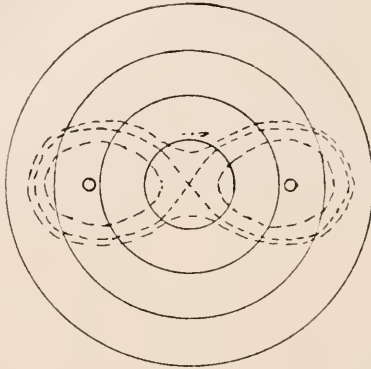

FIG. 65.

whose birefringence is equal to that of the acute bisectrix ($\gamma - \beta$), or ($\beta - \alpha$), as the case may be. Fig. 66 is similar to fig. 65, except that the

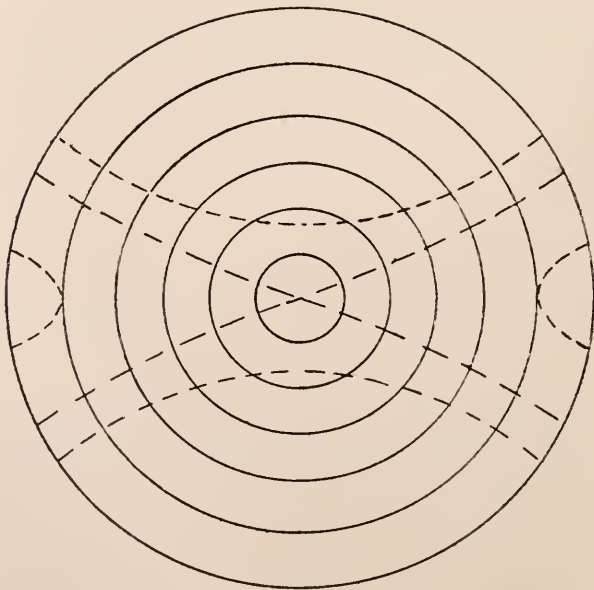

FIG. 66.

centre of the projection plate is the obtuse bisectrix ($2\nu = 45^\circ$). As in fig. 65 the directions whose birefringence is 10 p.c. greater or less than

that of the obtuse bisectrix are indicated. Fig. 67 is similar to fig. 65, except that the optic axial angle is $2\nu = 90^\circ$. The dotted curves again represent the directions for which the birefringence is 10 p.c. greater or less than that of the bisectrix at the centre of the projection plate.

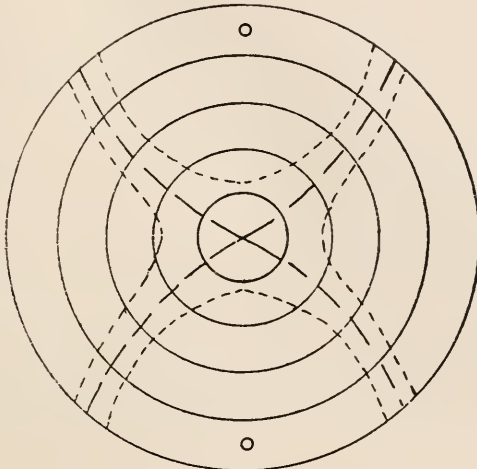

FIG. 67.

Plate *b* (figs. 59 and 68) is for the measurement of the optic axial angle, and is simply a thin glass plate 1.5 mm. wide, on which fine coordinate lines 0.1 mm. apart have been ruled. By means of this plate the optic axial angle of a mineral can be measured, provided one or both optic axes appear within the field of vision.

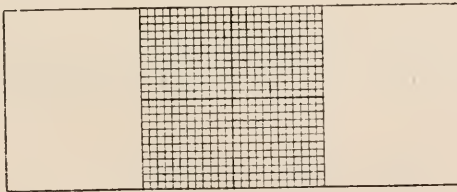

FIG. 68.

Plate *c* (figs. 59, 69, 70) is a bi-quartz wedge plate for the accurate determination of extinction angles. The dimensions are:—Plate of right-handed quartz: length 35.3 mm., width 6 mm., thickness at thin end 35 mm., at thick end 0.85 mm.; plate of left-handed quartz: length 35.3 mm., width 6 mm., thickness 0.4 mm. The thin plate is cemented on the wedge to a combination plate wedge which gives zero extinction at a distance 3.5 mm. from the thin end (fig. 70). The same specifications are followed with a wedge of left-handed quartz and

a plate of right-handed quartz, likewise superimposed and cemented side by side as indicated in the figure, and in such a way that the line of total extinction in the first combination is the extension of the line of

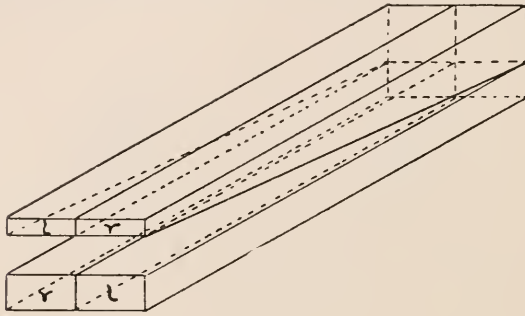

FIG. 69.

zero extinction in the second. This wedge in sodium light gives at the extreme end symmetrical extinction of about $\pm 10^\circ$ (fig. 70), while at the thin end it is $\pm 1^\circ$. Fig. 69 gives a view of the bi-quartz wedge showing relative positions of right- and left-handed wedges and under-

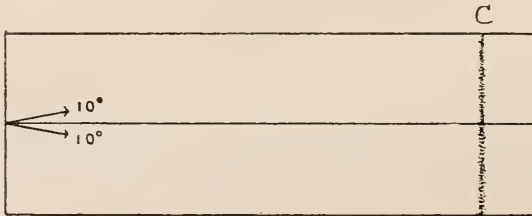

FIG. 70.

lying left- and right-handed quartz plates, all normal to the optic axis. Fig. 70 gives the top view of the bi-quartz wedge plate. The position of the dark line of zero rotation, or exact compensation, is indicated at C.

(3) Illuminating and other Apparatus.

Monochromatic Illumination.*—F. C. Hansen four years ago described a dry yellowish green (light-green, naphthol-yellow) light filter which, interposed between a Nernst light and the reflecting mirror of the Microscope, produced good illumination by means of which sharp images at high magnifications could be observed. The same author now recommends the use of this filter in combination with the mercurial vapour lamp of Schott. This lamp gives out yellow, yellowish-green, and blue rays, and by means of the yellow-green light filter, a clear monochromatic illumination is obtained.

* Zeitschr. wiss. Mikrosk., xxvi. (1910) pp. 525-6.

Ultra-microscopic Image.*—H. Siedentopf, in this treatise, goes very fully into the conditions underlying the formation of the ultra-microscopic image. The scope of his article will be gathered from the following list of its sub-divisions: 1. Limits of applicability of the ultra-microscope. 2. Dark-ground illumination by means of central diaphragms in the objective, and their disadvantages. 3. Dark-ground illumination by unilateral oblique light and the consequent azimuth-errors. 4. Dark-ground illumination by central diaphragms in the condenser, the cardioid condenser. 5. Variation of the diffraction disks by diaphragming the rear focal plane, by wrong use of the Microscope objective, and by obliquely placed cover-glasses. 6. Polarization of the light by diffraction of ultra-microns, and the corresponding appearances in the rear-plane of the Microscope objective. 7. Ultra-microscopic photography by rapid exposures. One of the plates illustrating the paper shows the Brownian movement of fine silver particles of about 20μ in a colloidal solution, taken with an exposure of $\frac{1}{50}$ of a second. The other plate illustrates (1) the variation of the diffraction-disks by diaphragming the rear focal plane; and (2) gives a valuable criterion for cover-glass correction with dark-ground illumination. A bibliography of 30 references is appended.

Aplanatic or Cardioid Condenser for Dark-ground Illumination.†

In section 4 of the article described in the foregoing abstract the author discusses the cardioid curve, and shows that its properties may be advantageously applied to the construction of a new form of dark-ground condenser. The cardioid, which derives its name from its heart-shape, is the curve traced out by a point on the circumference of a circle rolling on another circle of equal radius. It is the caustic curve assumed by rays reflected from a circular surface when the luminous origin is a point on the circumference of the surface. The polar equation to the curve is $R = r(1 + \cos u)$, when r is a constant. If the cardioid be combined with a circle of radius r , the circle being placed in a certain manner, then all rays incident parallel to the axis will, after reflections at the convex surface of the circle and at the concave surface of the cardioid, pass through the cusp of the cardioid. It follows, therefore, that the resulting ray-combination will be free from aberration. This will be understood from fig. 71, where ZZ is the common axis of cardioid and circle. OP is a ray parallel to the axis, reflected at P and P' . M is the centre of the circle.

If the ray is to converge to C , the final branch of the ray will be parallel to the radius PM , and the angle $P'CM$ will be equal to the angle of incidence u . Now it is a property of the cardioid that the angle i at P' , between the radius vector and normal, is equal to half the angle rotated by the radius vector, i.e., $i = \frac{1}{2} P'CM$.

This is proved thus ($P'CM$ being called u):—

$$\tan i = - \frac{dR}{R} \cdot du = \frac{\sin u}{1 + \cos u} = \tan \frac{u}{2}$$

Therefore

$$i = \frac{u}{2}$$

* Zeitschr. wiss. Mikrosk., xxvi. (1910) pp. 391-410 (2 pls. and 6 figs.). † Loc. cit.

It follows, therefore, that if the circle be suitably placed, the angle of convex reflection at the circle will be equal to the angle of radius vector rotation. The figure assumes that the proper position of the

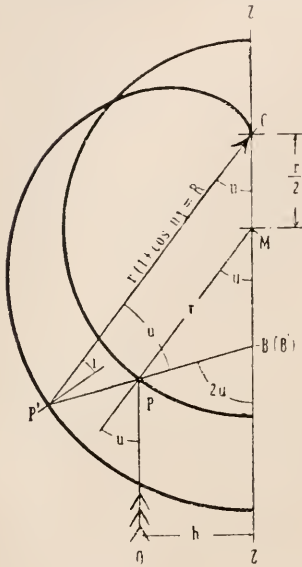

FIG. 71.

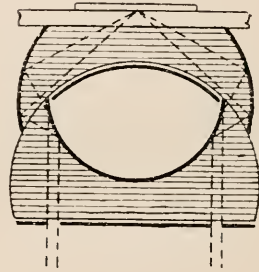

FIG. 72.

circle has been found: it only remains to fix the position of M, its centre. In the isosceles triangle B P' C—

$$2 B C \cos u = R = r(1 + \cos u).$$

Again,

$$B C = B M + M C = \frac{r}{2} \sec u + M C$$

whence by substitution and reduction $M C = \frac{r}{2}$. The point C, being the cardioid-cusp, is fixed, and the circle centre is therefore known. It will be noticed that the construction does not depend upon the value of r , which may consequently be chosen to suit the lens-maker's convenience.

The radius r may also be expressed by $r = \frac{h}{\sin u}$, and this property makes the ray aplanatic in Abbe's sense of the word.

Fig. 72 shows how the construction is applied by Messrs. Zeiss on their aplanatic or cardioid condenser for dark-ground illumination. Parallel to the axis incident rays pass through a ring-shaped opening in the central diaphragm of the condenser. The diaphragm is set accurately perpendicular to the condenser axis. The shaded part of the figure represents solid glass, and the course of the rays and their emergence and

aplanatic combination at the point corresponding to the cardioid-cusp are easily followed.

For successful use of the apparatus, Microscope objective and condenser, must be accurately centred upon each other, and the strongest available light-source (arc-light or sun-light) is required. For gas or electric incandescent light the paraboloid condenser, with its simpler management, will suffice.

Drawing on a Transparent Drawing-surface.*—H. Tafner points out that certain difficulties attend the use in strong light of such projection apparatus as that of Tandler and Edinger. The strong light throws such intense shadows that it is not altogether easy to trace in the outlines, especially when there is much detail. The author suggests that these difficulties may be overcome by projecting, not on to an opaque surface, but on to a transparent one. He finds that a successful method is to draw by means of an engraver's needle on a gelatin film spread out on a matt-glass sheet. Needles of varying degrees of coarseness may be used to suit the work. By the help of graphite or powdered red chalk the lines may be filled in, and the picture is like a photographic negative ready for copying, and many copies may be struck off by a press. The author describes the details of manipulation, and explains how certain difficulties can be avoided. It is also possible to transfer the gelatin film to a copper-plate.

(4) Photomicrography.

DAVIS, W. S.—Photomicrography with Simple Apparatus.

Photo Era, 1908, p. 20.

GARJEANNE, A. J. M.—A Home-made Photomicrographic Apparatus.

The Photograph Monthly, xvi., p. 28.

MARKTANNER-TURNERETSCHER, G.—Wesentlichere Fortschritte auf dem Gebiete der Mikrophotographie und Projection.

Jahrb. f. Photogr. u. Reprodukt. für d. Jahr 1909.

Published by J. M. Eder.

MILNE, J. R.—A Special Form of Photographic Camera for recording the Readings of the Scales of Scientific Instruments.

Proc. Roy. Soc. Edinburgh, xxix. (1908) pp. 176–81.

MONPILLARD, M.—Nouveau dispositif pour la microphotographie instantanée de M. Briandeau à Nantes.

Bull. Soc. franç. de Photogr., xxv. p. 73.

REID, J.—Photography and the Microscope; more particularly a Method of Calculating the correct Exposure.

Photog. Journ., xlix. p. 33.

(5) Microscopical Optics and Manipulation.

Measurements in the Long-waved Spectrum.†—H. Rubens and H. Hollnagel give the following summary as the result of their investigations: 1. The wave-length and energy distribution of the ultra-rays of rock-salt, sylvine, potassium bromide, and potassium iodide were examined by means of a quartz interferometer. 2. It was found that the ultra-rays of rock-salt, sylvine, and potassium bromide were composed of two series of differing intensity. This is perhaps also the case

* *Zeitschr. wiss. Mikrosk.*, xxvi. (1910) pp. 384–6.

† *SB. k. Akad. Wiss.*, 1910, pp. 26–52 (11 figs.).

with the ultra-rays of potassium iodide. 3. The wave-length of each series is stated in the following table. That of the stronger series is indicated by λ_1 , that of the weaker by λ_2 , the "medium" being λ_0 . The table also gives the molecular weight M of the substances.

Ultra-rays from	λ_1	λ_2	λ_0	M
Rocksalt	53.6 μ	46.9 μ	51.7 μ	58.5
Sylvine	62.0	70.3	63.4	74.6
Potassium bromide	86.5	75.6	82.3	119.0
Potassium iodide	96.7	166.0

It is to be noticed that the medium wave-lengths increase with the molecular weights—more slowly than the molecular weights, but more rapidly than their square roots. (The "medium" is got by dividing the half-wave length into the distance between two adjacent maxima or minima.) 4. The refractive index of water is about $n = 82.3 \mu$, and is of the same order of magnitude as in the visible spectrum. 5. By examination of the ultra-rays of potassium bromide our knowledge of the spectrum has been increased by about half an octave. The spectrum now comprises ten complete octaves, of which two are in the ultra-violet, one in the visible region, and seven in the ultra-red.

Phenomena of Light-polarization in Solid and Pseudo-liquid Organized Matter.*—P. de Heen points out that, according to present ideas, matter is constituted by ionic fibres traversed by magnetic currents or by currents of ether, and all the phenomena of polarization are the result of the orientation of these magnetic fibres or of the predominant action of certain orientations (polarization by reflection or by refraction). It is interesting to enquire what difference exists between a network of fibres oriented to form a magnetic field and a network of fibres active as regards polarization of the light. The only difference lies in the circumstance that, to obtain an active substance, all the atomic bobbins must be wound in the same sense. The author explains fully his reasons for arriving at this conclusion.

(6) Miscellaneous.

Quekett Microscopical Club.—The 465th Ordinary Meeting was held on April 26, at 20 Hanover Square, W., the President, Professor E. A. Minchin, M.A., F.Z.S., in the Chair. Mr. A. E. Hilton read a paper on "The Life-phases of Mycetozoa." The author gave a detailed description of the life-cycle of this group, which includes less than 300 species, and said that this small group offered exceptional opportunity for studying life-phenomena, as the processes were less obscured than in many other organisms. Mr. Hilton exhibited active living swarm-spores of Mycetozoa $\times 500$. Mr. James Burton read a note on "Two Instances of Breaking of the Meres." The term may be defined as that

* Bull. Classe Sci., Acad. Roy. Belg., 1910, pp. 23-30 (5 figs.).

condition of a body of fresh-water when it is so permeated with one or more species of microscopic algæ as to be visibly affected by their presence. In the two instances observed the phenomenon was due to the presence in large quantity of the alga *Oscillatoria*; one of the species was probably *O. ayardhii*, the other is still unidentified.

The 466th Ordinary Meeting was held at the Morley Hall, Hanover Square, on May 24, the President in the Chair. The Hon. Sec., Mr. W. B. Stokes, exhibited and described a specimen of Burche's micrometer. Messrs. Baker exhibited a number of preparations of Crustacea injurious to wooden piers and piles. Two of the most interesting were of the Isopods *Leptochelia sairgnii* and *Arcturus* (?) sp., both very rare.

The 467th Ordinary Meeting was held on June 28 at the Doré Gallery, New Bond Street, Mr. C. F. Rousselet, Vice-President, in the chair. Mr. A. C. Banfield described and exhibited a sliding nose-piece for taking stereophotomicrographs. Referring to his method described before the Club on October 26 last,* when, to obtain the stereoscopic effect, the object is moved, he said that with low powers and strongly lighted opaque objects the shadow of the object floated in space and gave an irritating result. In the fitting exhibited a sliding plate is screwed to carry the objective which is laterally displaceable by rack-and-pinion. In practice the device works exceedingly well. Transparencies were exhibited showing the advantages of the new method. Mr. D. Bryce gave an account of his new "classification of the Bdelloid Rotifera." It is not possible in the space here available to give an abstract of value. The complete paper will be published in the next (November) issue of the Journal of the Quekett Microscopical Club. Mr. E. M. Nelson, F.R.M.S., communicated a paper on "*Navicula rhomboïdes* and allied forms." The first part of the paper referred to the old question as to the identity of the diatom known as the Amici test. The author concludes that Professor Amici had no one particular test, and that the test as known in America differed from that used here. In the second part the author suggests the use of an "Index Number," to be used when describing the minute differences of similar species or varieties. Such an index, it is suggested, may be found by dividing the number of the transverse striæ by the length-breadth ratio. Examples were given. Mr. A. Earland read a paper on "Arctic types of Foraminifera in the North Sea." The material examined was dredged by the s.s. 'Goldseeker,' employed by the International North Sea Commission. The particular and characteristic boreal forms were described, and many were exhibited. Concluding his remarks, the author said that in the area of the North Sea, as far north as Noss Head, there is a survival of the fauna of the old Arctic North Sea before the submergence of the land. Among the Orkneys and Shetlands there are records of warm water types which are probably gradually spreading outwards and downwards.

* See this Journal, 1910, p. 233.

B. Technique.*

(1) Collecting Objects, including Culture Processes.

New Anaerobic Apparatus.†—O. Lentz describes a simplified method of cultivating anaerobes upon Petri dishes. This consists in an application of the pyrogallic and potash method, and the materials are prepared in the following way. Disks of blotting-paper, of a diameter of 8·7 cm. and thickness of 0·6 cm., are soaked first in a watery and next in an alcoholic pyrogallic solution. Disks so prepared remain serviceable for about a week. To facilitate the subsequent observation of colonies the centre of the disk is cut out, leaving a ring of the "pyrogallic cushion" with an internal diameter of 4·5 cm. Such a ring is placed upon a glass plate of about 12 cm. square, and is then edged with a pencil of plasticine. The plate, gelatin, agar, or the like, is then inoculated and placed for the moment in the Petri cover. Then about 15 c.cm. of 1 p.c.

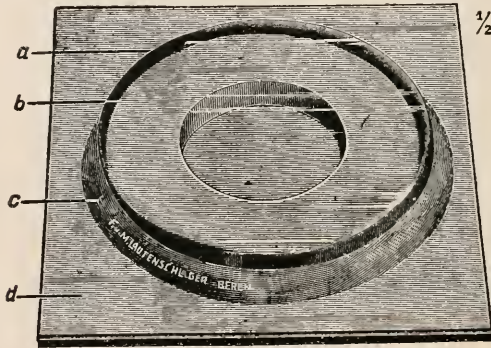

FIG. 73.

watery potash is poured over the pyrogallic pad and the plate is immediately inverted over it (fig. 73). The plasticine is then worked so as to make an efficient air-tight joint. The author tested the excellence of the anaerobic conditions obtained by attempting to cultivate strict aerobes, such as the *Vibrio cholerae*, and by decolorising media stained with methylen-blue. Both tests were most satisfactory. The author has also devised a modification of this method applicable to tubes and flasks.

Method of Obtaining Yeast-spores.‡—A. Gorodkova uses the following medium: water 100, agar 1, pepton 1, broth 1, sodium chloride 0·5, glucose 0·25. Slopes are made, and, after inoculating with yeast-cells, are incubated at 28°C. Spores form in two or three days.

* This subdivision contains (1) Collecting Objects, including Culture Processes; (2) Preparing Objects; (3) Cutting, including Imbedding and Microtomes; (4) Staining and Injecting; (5) Mounting, including slides, preservative fluids, etc.; (6) Miscellaneous.

† Centralbl. Bakt., 1^{te} Abt. Orig., liii. (1910) pp. 358-65.

‡ Bull. Jard. Imp. Bot. Pétersbourg, through Zeitschr. wiss. Mikrosk., xxvi. (1909) p. 583.

Differential Diagnosis of *Bacillus typhosus* and *Bacillus coli* by means of Coloured Cultivation Media.*—E. Calandra used the following media: 1. Broth and gelatin stained with litmus. 2. Media stained with picroic acid and litmus. 3. Broth and gelatin with brilliant cresyl-blue. 4. Broth with Congo red. 5. Broth with neutral red. 6. Broth with Kuhne's alkali blue. The author claims that there are obvious differences produced in the media by the action of these two organisms: verbal description is inadequate to convey these differences, and ocular demonstration is necessary. They presumably depend on acidifying action of *B. coli*.

Cultivating *Bacillus tuberculosis*.†—A. Frouin has devised a medium which is said to be specially favourable to the growth of the tubercle bacillus. It is composed of water 1000, sodium chloride 6, chloride of potassium 0·3, disodium phosphate 0·5, magnesium sulphate 0·3, calcium chloride 0·15, glycerin 40, glucosamin 2, sarcosin 2. The solution is neutralised, sterilised, filtered, distributed into flasks and sterilised anew. Though growth for the first fortnight after inoculation is slow, in four weeks it is abundant, and by that time a thick film has formed.

Cultivation of the Leprosy Bacillus.‡—M. T. Clegg gives further details as to the cultivation of the leprosy bacillus.§ Inoculations were made from the spleens and cutaneous nodules of ten lepers. In eight of the ten instances an acid-fast bacillus was obtained in transplants of amoebal cultures, to which the leprosy material had been added. By heating such an amoeba-cholera-leprosy culture for $\frac{1}{2}$ hour at 60° C. and incubating, colonies of the leprosy bacillus were obtained, which grew readily in pure culture when transplanted to the ordinary laboratory media (e.g. agar, broth, eggs). Guinea-pigs inoculated subcutaneously with the pure culture developed in some instances lesions at the site of inoculation which bore a certain resemblance to the leprosy lesions of man, both macroscopically and microscopically. The acid-fast organisms were found at the site of inoculation, and in some instances also in the spleen.

(2) Preparing Objects.

Fixation of Algæ by means of Quinone.||—When fixing vorticellæ on fresh-water algæ by means of quinone, A. Bonnet made observations as to the effect of the reagent on the algæ. He found that a 4:1000 solution gave excellent results. Sea-water may also be used, but the solution turns brown more rapidly than in fresh-water. Once fixed, the algæ are more resistant to contraction and deformity when being dehydrated preparatory to mounting in glycerin-jelly, in glycerin, or in Canada balsam. The chlorophyll stains greenish-brown; spores and eggs brown, the rest of the protoplasm yellow, and the cellulose membranes are unaffected.

* Centralbl. Bakt., 1^{te} Abt. Orig., liv. (1910) pp. 567-75.

† C.R. Soc. Biol. Paris, lxxviii. (1910) p. 915.

‡ Philippine Journ. Sci., iv. (1909) pp. 403-14 (2 pls.).

§ See this Journal, 1909, p. 661.

|| C.R. Soc. Biol. Paris, lxxviii. (1910) pp. 957-8.

(3) Cutting, including Imbedding and Microtomes.

Dissecting Tile and Stand.*—The tile itself (fig. 74), 6 in. square, half black and half white, is well glazed all over to prevent it soaking up stain, etc., the black being put on before glazing. The stand was devised to meet the demand for a cheap and effective arrangement for class use. The jointed lens-holder has a spring clip to take an ordinary pocket lens and is arranged to slide on a pillar for focusing. A slightly more expensive kind has a drawer for dissecting instruments, etc. The tile is made by Flatters and Garnett, Manchester.

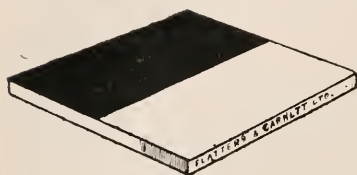

FIG. 74.

(4) Staining and Injecting.

Modification of Neisser's Staining for Diphtheria Bacilli.†—P. Sommerfeld makes films of blood-serum or glycerin-agar cultures and

stains them with methylen-blue (alcoholic or aqueous or Loeffler's); washes with water, dries on blotting-paper, and then treats for a few seconds with a mixture of equal parts of alcohol and formalin. When the preparation is almost colourless it is washed and then dried. Smears from diphtheritic membrane require a longer treatment with formalin. The granules are stained dark blue, the bacterial body being pale blue. Contrast staining, though superfluous, may be effected with vesuvin, chrysoïdin, or eosin.

New Method of Staining Spores.‡—A. F. S. Kent recommends the following procedure for demonstrating the presence of spores. A film is prepared and fixed in the usual way. It is then treated with a solution of sodium hydrate for some seconds, after which the still wet film is stained with phenol-fuchsin, heated as usual for a few minutes. The next steps are to decolorise with 25 p.c. hydrochloric acid, wash, counterstain with methylen-blue, then wash, dry, and mount.

Staining Moist Preparations and Sections by the Azur-eosin Method.§—G. Giemsa points out some advantages of the application of his staining method to moist preparations. By means of this he can demonstrate the minute structure of the nuclei of trypanosomes and *halteridia*. In dry preparations of amœbæ the karyosome in the centre of the nucleus is indicated in a shadowy manner, while in wet preparations it stands out sharp and distinct. This method is also useful for showing the blepharoplast in *halteridia*, and its relation to the basal portion of the flagellum. The study of sections and of the minute structure of bacteria is also facilitated by this means.

New Colour Reaction for certain Albumins.||—W. Arnold has applied the sodium-nitroprusside-ammonia reaction to the investigation of different albumins. The details of the method are as follows: To 1 or 2 c.cm. of the albumin solution are added a few drops of a 4 p.c.

* Catalogue B, 1910, p. 28.

† Deutsche Med. Wochenschr., 1910, p. 505.

‡ Lancet, 1910, i. p. 1473.

§ Centralbl. Bakt., 1te Abt. Orig., liv. (1910) pp. 489-90.

|| Bull. Internat. Acad. Sci. Cracovie, 1910, pp. 56-60.

solution of sodium nitroprusside. Upon the further addition of some drops of an ammonia solution, a deep permanent purple-red colour appears, which is discharged immediately upon the addition of acetic acid. The author found that this reaction was demonstrated to perfection upon the soluble albumins of the crystalline lens. The muscle globulins did not give such a distinct reaction, but a deep purple colour was obtained with myostromin and with acid albumin. After myostromin had been digested by means of pepsin and hydrochloric acid, a carmine-red colour was obtained upon application of the test. Further digestion products, such as the amino-acids, gave no reaction. A negative result was obtained with gluten, and mucin gave only a feeble coloration.

(5) **Mounting, including Slides, Preservative Fluids, etc.**

Terpineol for Microscopic Purposes.*—According to P. Mayer, fluid terpineol has certain advantages over oil of cloves and other clearing agents. It is colourless and remains so permanently. It has no smell. It is miscible with benzol and xylol in all proportions. Sections can be transferred from 90 p.c., or even if necessary from 80 p.c. alcohol directly into this fluid. It has a lower refractive index than oil of cloves and objects cleared in it can be examined directly, before proceeding to the final stages of washing with xylol and mounting in balsam. It is considerably cheaper than other clearing agents.

(6) **Miscellaneous.**

Preparation of Osteological Specimens.†—B. Mozejko describes a method by means of which specimens suitable for investigation can be prepared in a very short time. For instance, the bones of an animal of the size of a guinea-pig can be obtained in a suitable condition in one day. Soft parts, viscera and muscles, are first of all removed so as to leave skeletal structures roughly free. The material is then treated in a boiling solution, until all the soft parts are thoroughly cooked. For large objects a solution of eau-de-Javelle, for smaller animals a soda solution is used. Small and delicate objects must be boiled in water. From this fluid the material is transferred to alcoholic liquor potassæ. The concentration of this solution should vary with the size of the object. After maceration in this fluid, the specimen is transferred to a water bath. The water is changed daily until it is found no longer to become turbid. If it be desired to disarticulate the skull bones, the specimen should remain longer in the macerating fluid.

Formalin for the Preparation of Museum Specimens.‡—B. Mozejko found that animals could be preserved in good condition by injections of 5 to 8 p.c. formalin into the cranial, pleural and peritoneal cavities, and has for some years used this method for studying the anatomical relations of the viscera. He now gives an account of the technique employed for the preparation of museum specimens. Animals anaesthetised with ether were killed by strangulation and injected as above by Kaiserling's formalin-saline mixture. The specimen is then prepared by Kaiserling's process. The author finds that in the case of

* Zeitschr. wiss. Mikrosk., xxvi. (1910) pp. 523-4.

† Anat. Anzeig. xxxvi. (1910) pp. 314-16.

‡ Tom. cit., pp. 317-18.

small animals his method is more satisfactory than vascular injection. In the case of birds and small mammals so injected, he found that the specimen passed into a state of mummification without any decomposition. Such mummified specimens are very suitable for the demonstration of certain anatomical points.

Glycerin Jelly Bath.*—This apparatus consists of a copper box, to contain water, $5\frac{1}{2} \times 2\frac{1}{2} \times 3$ in., on a separate iron stand, as figured (fig. 75). There is a hole at one end to take the bottle of glycerin jelly. In the centre there is a space with movable shelf, for slips and covers. In use, the box is nearly filled with water, and the bottle of jelly, slips, etc., put into position, and a spirit lamp or Bunsen burner placed underneath. When the jelly is melted, the box is removed from the stand and placed on the table (it is a convenient height for mounting upon); a warmed slide or so may then be placed on the top of the box;

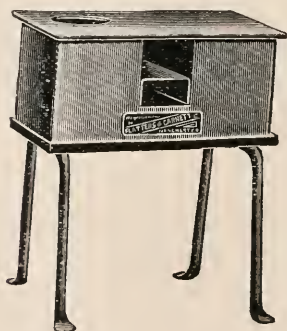

FIG. 75.

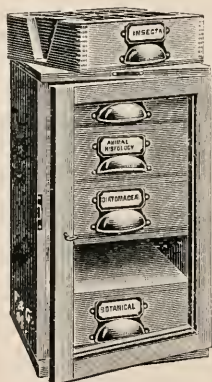

FIG. 76.

the objects can easily be arranged in the liquefied jelly. The lid is removable, and may be placed directly upon the iron stand when a greater heat than that obtainable with the water-bath is required. The apparatus is made by Flatters and Garnett, Manchester.

Microscope Slide Cabinets.†—The new style of cabinet recently introduced by Flatters and Garnett is much more compact than the usual type, e.g. a cabinet, with glass door, to hold 720 slides only measuring $18 \times 10 \times 10$ in. They are made in several sizes, and in either mahogany or pine. In the 720 size, there are five drawers, with brass handles at front and space for contents card; the two sides of each drawer are cut away to allow of the removal of the slide trays, of which each drawer holds twelve, each tray in turn holding twelve 3×1 in. slides in separate divisions. Such an arrangement allows of immediate access to any desired slide; slides do not ride on top of one another, and those relating to a particular subject may be kept in the same drawer (fig. 76).

* Catalogue B, 1910, p. 41.

† Tom. cit., p. 59.

Drawer Units of stout card, covered with book-cloth, are made on a somewhat similar plan, except that each drawer is a separate "unit" for 72 slides. They consist of an outer sheath measuring $8 \times 4\frac{1}{4} \times 3\frac{1}{4}$ in., with a drawer with cutaway sides, and handle with space for contents

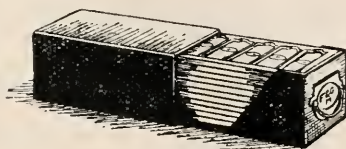

FIG. 77.

card at front, and contain twelve trays, each to hold six 3×1 in. slides in separate divisions. They are very durable, and a number may be arranged in any desired manner, as the collection of slides grows. Similar "units" are made without trays, and with drawers not cut down at the sides; they are useful for storing the various oddments incidental to microscopical work (fig. 77).

Metallography, etc.

Cobalt-gold Alloys.*—W. Wahl has determined the equilibrium diagram of this system by thermal and microscopical methods. Observations were also made on magnetic properties and crystalline form. Cobalt and the cobalt-rich alloys exhibited super-cooling to a remarkable degree. The super-cooling of cobalt appeared to increase with greater purity of the metal, and amounted to 200° C. in one experiment. Inoculation was employed in taking cooling curves. No compounds exist in the system, at either end of which mixed crystals, saturated at low concentration, occur. The eutectic melts at 997° C. and contains 90 p.c. gold.

Lead-tin Alloys.†—W. Guertler suggests, in view of the results obtained by Rosenbain and Tucker, and by Degens, that the evolution of heat at about 150° C. may either be due to the decomposition of mixed crystals of lead and tin or to the formation of a compound of about the composition Sn_3Pb_4 . The author has calculated the heats of fusion of different lead-tin alloys from published data, and finds them much greater than the means of the heats of fusion of the components. Heat is therefore evolved when molten lead and tin are mixed.

Nickel-carbon Alloys.‡—K. Friedrich and A. Leroux have determined the melting-point diagram of the nickel-carbon system for the range 0 to 2.6 p.c. carbon. The alloys contained 0.2 to 0.6 p.c. iron.

* Zeitschr. Anorg. Chem., lxvi. (1910) pp. 60-72 (3 figs.).

† Zeitschr. Elektrochem., xv. (1909) pp. 953-65, through Journ. Chem. Soc., xcvi. (1910) p. 126.

‡ Metallurgie, vii. (1910) pp. 10-13 (7 figs.).

Up to about 1 p.c. carbon a solid solution only is formed; microscopic examination indicates that the limit of solid solubility lies at about 0.9 p.c. carbon. When more carbon is present a eutectic containing between 2 and 2.5 p.c. carbon, and melting at 1307° to 1318° C., is formed. Alloys containing 2 to 2.5 p.c. carbon appear to consist, microscopically, wholly of eutectic, while a suggestion of primary crystals of the carbon-bearing phase may be observed in the alloy with 2.6 p.c. carbon. No difference in micro-constitution between alloys slowly cooled and those water-quenched from the molten state could be detected.

Lead Bronzes.*—F. Giolitti and M. Marantonio have studied the ternary system copper-tin-lead, in the range 0 to 20 p.c. lead, 0 to 25 p.c. tin. No compounds are formed in the binary system copper-lead, the components are incompletely miscible in the liquid, and immiscible in the solid state, and the eutectic temperature is practically the melting-point of lead. In the ternary alloys the tin exists either as Cu_3Sn or Cu_5Sn . The hardness of the alloys was investigated.

Magnetic Properties of Manganese, Vanadium, and Chromium.† P. Weiss and K. Onnes have found that at the freezing point of hydrogen (14° absolute) the magnetic properties of manganese, vanadium, and chromium are still very feeble. These metals therefore neither become ferro-magnetic nor obey Curie's law of paramagnetism. The magnetic properties of a crystal of ferrous sulphate became enormously stronger at low temperatures. Ferro-magnetic manganese was obtained when very pure reduced manganese in the form of powder was melted in a current of hydrogen.

Magnetic Properties of Iron and Alloys.‡—C. F. Burgess and J. Aston have determined the magnetic and electrical properties of seven iron-silicon alloys, prepared from electrolytic iron, and containing 0.23 to 4.65 p.c. silicon, as forged, annealed at 675° C., annealed at 1000° C., and quenched from 900° C. The addition of silicon does not appear to bring about the same improvement in magnetic properties in electrolytic iron as in commercial mild steels. Electrical resistance increases with increase of silicon content; the resistance of the 4.65 p.c. Si alloy is five times that of electrolytic iron.

The same authors§ have made similar tests on electrolytic and other samples of iron, of varying degrees of purity, and also on a number of samples of commercial iron and steel.

Phosphides of Iron.||—N. Konstantinow has taken cooling curves of thirty alloys, containing 0.5 to 21.0 p.c. phosphorus, and gives an equilibrium diagram, differing in some respects from Saklatwalla's, based on the thermal results and on the microstructure of the alloys. Some of

* *Gaz. Chim. Ital.*, xl. (1910) pp. 51-77, through *Journ. Chem. Soc.*, xviii. (1910) pp. 504-5. † *Comptes Rendus*, cl. (1910) pp. 687-9 (1 fig.).

‡ *Met. and Chem. Engineering*, viii. (1910) pp. 131-3 (6 figs.).

§ *Tom. cit.*, pp. 191-4 (6 figs.).

|| *Zeitschr. Anorg. Chem.*, lxvi. (1910) pp. 209-28 (10 figs.).

the melts were inoculated during cooling, to prevent supercooling, to which they showed a marked tendency. The existence of Fe_3P and Fe_2P is confirmed. A comparative table of the phosphides, arsenides, and antimonides of manganese, iron, cobalt, nickel, and copper, is given.

O. Kuhn,* in preparing copper phosphide, obtained a product which on solution in nitric acid, left a residue of glistening needles, insoluble in nitric acid, and corresponding approximately to the formula Fe_5P_2 . The author considers this to be another definite compound, in addition to the four the existence of which is admitted by Le Chatelier and Wologdine.

Decarburisation of Cast Iron by Gaseous Oxidising Agents.†—H. Becker has studied the action of mixtures of carbon monoxide and carbon dioxide upon cast iron at different temperatures, determining the amount of decarburisation by chemical and microscopical examination. The decarburisation is greater as the proportion of carbon dioxide and the temperature increase. Decarburisation ceases when the proportion of CO_2 falls to 30 p.c. at 800°C . to 12 p.c. at 900°C ., and to 2.85 p.c. at 1000°C . White iron appears to decarburise less readily than tempered cast iron at 800°C . A mixture containing 28 p.c. CO_2 will decarburise cast iron at 900°C . without oxidising the iron noticeably. A 24 p.c. CO_2 mixture acts similarly at 1000°C .

Cementation of Steel.—F. Giolitti and L. Astorri‡ find that the addition of a little benzene vapour to carbon monoxide, used as a cementation medium, increases the concentration of carbon in the outer layers of the steel. If the proportion of benzene be increased beyond a certain value, carbon is deposited on the surface of the steel, and the concentration of carbon in the outer layer reaches the value given by solid cementation media. The authors have found cementation to occur when very mild steel and powdered charcoal are heated to 1000°C . in a vacuum, in intimate contact.

F. Giolitti and F. Carnevali § have studied the effect of strongly compressing gases used in cementation.

Improvements in Metallographical Methods.||—R. Loebe describes the following new devices which he has used in determining cooling curves, standardizing thermocouples and similar work. (1) A clock giving audible signals at definite short equal intervals of time; (2) a modification of the wire method of taking melting points. The melting of a wire of the metal under investigation, fixed across the ends of two platinum wires, causes a bell to ring by breaking an electrical circuit. The temperature is indicated by a thermocouple with its hot junction close to the melting wire. (3) An electric resistance tube furnace; (4) clamps for holding a pyrometer centrally in the same furnace;

* Chemiker Zeitung, xxxiv. (1910) pp. 45-6.

† Metallurgie, vii. (1910) pp. 41-59 (17 figs.).

‡ Gaz. Chim. Ital., xl. (1910) pp. 1-20, through Journ. Chem. Soc., xcviii. (1910) p. 507.

§ Atti R. Accad. Sci. Torino, xlv. (1910) pp. 337-45.

|| Metallurgie, vii. (1910) pp. 5-10 (12 figs.).

(5) carbon crucibles for melting ; (6) stirrers for keeping molten metal in motion while a cooling curve is taken.

Invariant Systems and the Composition of Eutectics.*—A. Gorboff discusses the application of the phase rule to the composition of eutectics, and from an examination of the results obtained by numerous investigators, concludes that eutectics follow the law of multiple proportions. Thus the composition of a eutectic may be expressed, like that of a compound, by a chemical formula with rational indices. Some further general rules governing the composition of eutectics are given.

Microscopy and Macroscopy in Workshop Practice.†—J. E. Stead has collected from many manufacturers and investigators opinions as to the value of microscopical study of metals, and quotes a number of typical opinions. He then describes cases in which metallographic methods have proved of great use. A steel casting, before annealing, usually has a skin of somewhat higher carbon content than the interior. This surface layer is decarburised by annealing. Microscopic examination will reveal whether a casting has been annealed or not, and if so, will indicate if a suitable temperature has been employed. Etching the surface of a casting with 20 p.c. nitric acid after rough polishing will show if electric welding has been practised, and whether electrically welded steel has been subsequently annealed or not. The heating by friction of wire ropes sometimes leads to the formation of a dangerously brittle and hard skin in the subsequent rapid cooling. Such a brittle skin can be detected by the Microscope. Many other instances are given.

Formation of Alloys by Pressure.‡—W. Spring agrees with Tammann that the formation of alloys under pressure is a result of diffusion, which is not accelerated by the pressure.

Specific Heat of Metallic Alloys.§—A. V. Saposhnikoff has determined the specific heats at 15° to 100° C. of a number of binary alloys belonging to four typical systems : (1) bismuth-cadmium ; (2) lead-tin ; (3) bismuth-antimony ; (4) zinc-antimony. Regnault's law, which requires that the specific heat of an alloy should be equal to the mean arithmetical specific heat of its components, is confirmed.

Mounting of Metal Sections.||—E. Preuss describes the following as a new method. The section, which may be quite irregular in shape, is placed on a level surface with the polished face down. A brass ring with parallel ends is placed over it and the spaces between section and ring filled up with plasticine. The ring with the section thus fixed in it is mounted on a slide with the polished face up.

* Journ. Russ. Phys. Chem. Soc., xli. (1909) pp. 1241-1300, through Journ. Chem. Soc., xcvi. (1910) p. 111.

† Proc. Int. Assoc. for Testing Materials, No. 15 (1910) pp. 205-10 (26 figs.).

‡ Zeitschr. Elektrochem., xv. (1909) p. 984, through Journ. Chem. Soc. xcvi. (1910) p. 126.

§ Journ. Russ. Phys. Chem. Soc., xli. (1909) pp. 1708-11, through Journ. Chem. Soc., xcvi. (1910) p. 182.

|| Stahl und Eisen, xxix. (1909) p. 239 (2 figs.).

C. F. W. Rys * points out that the use of plasticine for mounting is not new, and describes the well-known method, given by J. E. Stead in 1900, in which parallelism of slide and polished face is obtained by means of a brass ring in a much simpler manner than that described by Preuss.

Electron Theory and Solid Solutions of Metals.†—R. Schenck attempts a theoretical explanation of the diminution of electrical conductivity and of the increase of the ratio of the thermal to the electrical conductivity in the case of metallic solid solutions. The decrease in electrical conductivity appears to be due to increased viscosity.

“Damping” Test of Metals.‡—O. Bondouard has devised methods for recording photographically the curve representing the damping of the vibrations set up by means of an electromagnet in a steel bar. A steel containing 0.3 p.c. carbon was tested (1) as rolled, (2) annealed, (3) hardened.

Thermo-electric Properties of Metallic Alloys.§—W. Haken has determined the thermo-electric forces produced at the junctions of copper with alloys belonging to the binary systems tellurium-antimony, tellurium-tin, tellurium-bismuth, tellurium-lead, antimony-silver, copper-phosphorus. The curves representing the relation between composition and thermo-electric properties, and between composition and electrical conductivity, are compared with the equilibrium diagrams obtained by thermal methods. The existence of compounds and of solid solutions is indicated by the thermo-electric method, which may accordingly be employed to check the conclusions drawn from thermal investigations.

Thermo-electric Properties of Alloys.||—W. Broniewski has collated published data relating to the thermo-electric properties of alloys. By comparing curves representing these properties as a function of the composition of binary systems, with the equilibrium diagrams obtained by thermal and other methods, he arrives at certain general laws. The author's conclusions are too lengthy for reproduction; he considers that the determination of thermo-electric properties may be a useful auxiliary method for the study of alloys. An extensive bibliography is appended.

Homogeneity of Metals.¶—G. Taguceff discusses the causes and the effects of non-homogeneity of metals, having regard especially to steel rails. Fracture under shock, and unequal wear, are in general due to non-homogeneity. The presence of manganese sulphide is detrimental.

Change of State in Metals under Mechanical Strain.**—A. Martens discusses in a general manner the behaviour of metals under tension,

* Stahl und Eisen, xxix. (1909) pp. 555-6 (3 figs.).

† Ann. Physik., xxxiii. (1910) pp. 261-90, through Journ. Chem. Soc., xcvi. (1910) p. 482.

‡ Comptes Rendus, cl. (1910) pp. 696-8.

§ Ber. Deutsch. Phys. Ges., 1910, pp. 229-39, through Journ. Chem. Soc., xcvi. (1910), p. 387.

|| Rev. Métallurgie, vii. (1910) pp. 341-67 (15 figs.).

¶ Proc. Int. Assoc. for Testing Materials, No. 15 (1910) 4 pp.

** SB. k. Preuss. Akad. Wiss., 1910, pp. 209-20 (9 figs.).

after different treatments. The effects of cold-working, annealing, etc., are illustrated by particular examples. Time has an important influence on the effects of stress, since, though stress is instantaneous, strain requires an appreciable time for its development, and may continue to increase for months. Thus different stress-strain curves are obtained by different rates of loading. Time effects are much greater in some metals than in others: the breaking-stress of zinc can be raised 50 p.c. by rapid loading. The effects of repetitions of stress, and the work done to produce fracture, are among other points discussed.

Internal Friction of Solids at Low Temperatures.*—C. E. Guye and V. Freedericksz have determined the rate at which torsional vibrations die away in silver, aluminium, gold, magnesium, iron, and quartz, at 100° , 50° , 0° , -80° , and -196°C . For silver, aluminium, and iron, the "coefficient of damping" diminishes with falling temperature, but apparently does not tend to disappear entirely at the absolute zero. The coefficient of elasticity of the metals becomes greater as the temperature is lower.

C. E. Guye and H. Schapper † have made similar determinations on copper, zinc, gold, nickel, palladium, and platinum. The coefficient of damping was found to vary with the amplitude of the vibration. In general, it cannot be said that this coefficient steadily decreases as the temperature falls. It does not seem possible to arrive at any general laws governing the value of the coefficient of damping.

Novel Application of Alloys.‡—Most alloys throughout a certain range of temperature are partially solid and partially liquid. K. Friedrich incorporates with partially solidified alloys in a pasty and workable condition, solid substances in the form of powder. The examples described are (1) an alloy of 90 p.c. tin and 10 p.c. copper heated to 500°C . and allowed to cool to 220°C . Maintained at this temperature the alloy was pasty; a quantity of powdered blue glass was mixed with it, the mixture pressed and allowed to cool. A polished section showed a white metallic ground sprinkled with blue particles. (2) An alloy of 98 p.c. lead and 2 p.c. antimony, mixed at 250°C . with 10 p.c. iron filings. Pressed and cooled it gave a "hard lead." Possible uses for such pseudo-alloys are discussed.

Solubility of Gases in Metals and Alloys.§—A. Sieverts and W. Krummhaar have determined the amount of various gases dissolved by different metals and alloys, under varying conditions of temperature and pressure. Experiments at very high temperatures were carried out in porcelain tubes heated in a silundum tube resistance furnace. Nitrogen is insoluble in most metals, but forms nitrides with aluminium and with iron. Sulphur dioxide begins to dissolve in copper at the melting point; the solubility increases with the temperature, and is proportional to the square root of the pressure. Numerous other facts are given in the paper.

* Rev. Métallurgie, vii. (1910) pp. 85-6 (1 fig.).

† Comptes Rendus, cl. (1910) pp. 962-4.

‡ Metallurgie, vii. (1910) pp. 97-9.

§ Ber. Deutsch. Chem. Ges., xliii. (1910) pp. 893-900 (2 figs.).

New Method of Coating with Metals.*—U. Schoop describes a process of coating objects with a metallic layer. The metal is melted and projected against the object to be covered, as minute drops or powder, by means of a blast of reducing or inert gas at very high velocity. A remarkably homogeneous and adherent coating is obtained in this way. The process may be used for coating objects with aluminium.

Influence of Pressure on the Boiling-points of Metals.†—H. C. Greuwood has determined the boiling-points of bismuth, copper, lead, silver, and tin, at pressures in the neighbourhood of 100 and 250 mm. mercury. Boiling-points were determined at high pressures as follows:—Lead up to 11·7, bismuth up to 16·5, zinc up to 53 atmospheres. The effect of pressure was found to be very considerable; at 102 mm. bismuth boils at 1200° C., while at 16·5 atmospheres the boiling-point is 2060° C. For each metal the values of the boiling-points lie on a smooth curve.

F. HENNING.—Über ein Spektralpyrometer und einige optische Konstanten von Metallen. *Zeitschr. f. Instrumentenk.*, xxx. (1910) pp. 61–75 (2 figs.).

W. BROWN.—Permanent Steel Magnets. *Sci. Proc. Roy. Dublin Soc.*, xii. (1910) pp. 312–20 (3 figs.).

„ „ Chrome Steel Permanent Magnets. *Tom. cit.*, pp. 349–53 (1 fig.).

D. STENQUIST.—Alloys of Lead and Tin.

[A determination of the hardness of twelve alloys.]

Zeitschr. Phys. Chem., lxx. (1910) pp. 536–8 (2 figs.)

* Comptes Rendus, cl. (1910) pp. 1044–6.

† Proc. Roy. Soc., Series A, lxxxiii. (1910) pp. 483–91 (4 figs.).

PROCEEDINGS OF THE SOCIETY.

MEETING

HELD ON THE 15TH OF JUNE, 1910, AT 20 HANOVER SQUARE, W.,
 PROFESSOR J. A. THOMSON, M.A. F.R.S.E., PRESIDENT, IN THE
 CHAIR.

The Minutes of the Meeting of May 25, 1910, were read and confirmed, and were signed by the President.

The following Donation to the Society was announced :—

	From	
Report of the British Association, Winnipeg, 1909. (8vo,)		} Sir Frank Crisp.
London, 1910)		

The thanks of the Society were voted to the donor.

The President said that he had the pleasure of exhibiting two interesting and beautiful slides of a rare Synaptid sent by Mr. M. J. Allan, Geelong, Victoria. One slide showed the entire animal well cleared; the other showed the characteristic spicules, which have the form of hoops and complex wheels. It was interesting to recall the fact that the complex wheels in these Echinoderms had a gradual development from very simple, almost spherical, corpuscles. Mr. Allan had found the Synaptid in some abundance in Cario Bay, and, noticing some peculiarities, had regarded it as quite new. He had even given it a provisional name, *Amentum hamulus*. This was, however, unnecessary, for the specimen turned out to be the well-known, though rare, *Trochodota dunedinensis* (Parker), first described by Professor Jeffery Parker.

The President went on to say that he had sent the slides, which struck him as interesting, to two well-known authorities on Holothuroids, Professors R. Koehler and C. Vaney, of Lyon, joint authors of numerous important memoirs on Echinoderms. With characteristic courtesy, Professor Vaney had at once supplied the desired identification, and had indicated that the specimen was of considerable rarity and much interest. He expressed his desire to have a specimen, if there was any duplicate available. The Society was indebted to Professor Vaney for his identification of the specimen, and to Mr. Allan for sending it. He hoped that Mr. Allan would not be too much disappointed at learning that what he had found was not new. One of the services that the Society could render was to secure the identification of specimens by experts, and it was to be hoped that those benefited would remember the expert's desire for specimens.

Professor Vaney's letter, which did not, unfortunately, arrive in time to be read at the Meeting, may be included here:—

"*Trochodota dunedinensis* (Parker) is a Synaptid which seems to be very rare. All the specimens described have been collected in Otago Harbour, New Zealand. The specimen collected by Mr. Allan is 2 cm. in length. Its vermiform body shows at its anterior end a crown of ten tentacles, each with several pairs of lateral digitations. On three of these tentacles there is the reddish-brown spot noted by Parker, which some authors regard as a sensory organ. The skin is very transparent, and contains two kinds of spicules: (1) wheels with six rays, of variable size, the largest about 160μ in diameter, and (2) sigmoid corpuscles with the terminal points recurved in two different planes."

Dr. Hebb said that Messrs. Flatters and Garnett, Ltd., had sent several things for exhibition to the Society, one of which was a glycerin-jelly bath; another was a simple dissecting stand, with a drawer inside, and a fitting for a lens—made to meet a demand for a cheap stand for class use. They had also sent two cabinets for holding slides, one of which was a cardboard case, with loose trays for holding 72 slides; and the other was made of mahogany, with several deep drawers to hold boxes like the other, with spaces for labels in the front of each drawer. He had used the smaller kind, and had found it very useful.

Dr. Hebb also exhibited some photomicrographs of Mr. Grayson's rulings, and read a note by Mr. Nelson describing them.

The President read a paper, "On some Alcyonarians collected by Sir Ernest Shackleton's Antarctic Expedition." The specimens shown under Microscopes in the room were collected by Mr. James Murray at Cape Royds and adjacent places. The collection had been made under circumstances of the greatest difficulty, sometimes after cutting through 15 feet of ice. The conditions under which the collection was made were described in Part I. of the Reports on the Biological Results of the Expedition, and he wished to congratulate Mr. Murray on its publication. It was not only full of scientific interest, but was also fascinating as a record of fine achievement under extraordinary difficulties. As the specimens had been handed to him by Mr. Murray in the Society's rooms, he thought it was fitting that he should report the result of his investigation of them to the Society. He began to examine the collection with great expectations, hoping that something new would emerge, but his expectations had not been realised. Although the collection included many specimens, there were only four species, all of which had been found before. He had no more to offer than corroborations and amplifications of what previous observers had seen. Of the four species, one (*Clavularia rosea* Studer) had been previously obtained from Kerguelen Island; another (*C. chuni* Kükenthal) had been dredged from a depth of over 1000 metres from the Indian Ocean, near the equator; the third (*Alcyonium pæssleri* May) had been twice previously recorded from the Antarctic; and the fourth (*Ceratoisid delicatula* Hickson) was an exquisite colony of extraordinary beauty, originally de-

scribed by Professor Hickson from the 'Discovery' collection. The President went on to give a brief description of the four species, and said, in conclusion, that he felt it a privilege to share, even in this very indirect way, in the work of an expedition which had reflected so much credit on every one concerned.

Mr. James Murray said the Aleyouarians were a group which he knew very little about, but he had been very much interested in hearing Professor Thomson's remarks. He collected the material in which the specimens were found, but he was fortunate enough to secure the services of a very good marine biologist, Mr. Pearcey, who picked out the specimens, and got Professor Thomson to examine them. It was not expected they would be likely to get anything very different from what the 'Discovery' people got. He quite agreed with the President's remarks about the appetite for new species.

The President enquired how they managed to get delicate forms like *Ceratoisid delicatula* in such good condition.

Mr. Murray said they did not find any difficulty in preserving them, and took no particular precautions. Some were put into spirit and some were in formol.

The President said he noticed some of the specimens were in formalin, but this was a bad medium, as it had a slow corroding and eventually solvent effect on the spicules.

Mr. Heron-Allen was glad to have the opportunity of proposing a vote of thanks to the President for his very interesting communication. The President had spoken of the privilege he felt it to be to have had these specimens placed in his hands for examination, but he thought the Society should congratulate itself upon having so distinguished a biologist at their head that they were afforded the opportunity of having these interesting objects submitted to them at the earliest opportunity. He had great pleasure in proposing a very hearty vote of thanks to Professor Thomson for bringing these Arctic Aleyouarians before the Society.

The motion was unanimously carried by acclamation.

Dr. Hebb read a paper by Mr. E. M. Nelson, "On an Apparatus for Increasing the Power of an Achromatic Condenser."

Mr. Conrady has supplied the following considered account of his impromptu remarks:—

If Mr. Nelson expects to obtain a more brilliant flame-image by the addition of the doubly-reflecting glass ring he will certainly fail, for this would be directly contrary to the second law of thermodynamics. When Clausius first definitely stated this famous law, "That heat cannot be transferred from one body to another warmer than itself without a compensating expenditure of energy," doubts were expressed whether radiant heat—and therefore also light—did not form an exception; in other words, whether it was not possible by suitable lenses and mirrors to form an image more brilliant than the object itself. Clausius proved to everybody's satisfaction that this was impossible: that the best result possible was an image of the same intrinsic brilliance as the object, and that this was obtained with *any* corrected optical system which *also* fulfilled the sine-condition—of which latter Clausius was another early discoverer.

Clausius thus incidentally proved many years ago that any good condenser gives the brightest possible flame-image, and that any optical addition whatever to such a condenser must reduce the brightness of the flame-image, owing to absorption and other losses in the addition.

As in the arrangement proposed by Mr. Nelson more light undoubtedly enters the condenser than would enter without the added glass ring, the question remains to be answered: What becomes of this light; why is the flame-image not rendered brighter by it? It is rather surprising that Mr. Nelson did not discover the answer himself, for, on elementary considerations of the same type as those which led to the fixing of the Gauss principal and cardinal points, and to the definition of equivalent focal length, it is immediately obvious that the equivalent focal length of the condenser is increased by the addition of the glass ring in the exact proportion which the diameter of the pencil entering the glass ring bears to that which enters the condenser itself. Supposing this proportion to be as 2 to 1, then, as Mr. Nelson pointed out, twice as much light enters the glass ring as that which would get into the condenser direct. But simultaneously the focal length of the condenser, and, therefore, the linear dimensions of the flame-image, are doubled, and the area of the flame-image is therefore increased fourfold. We therefore, with the ring interposed, get twice the quantity of light spread over four times the area; in other words, the intrinsic brilliance of the flame-image, instead of being doubled, is actually halved by the interposition of the ring. The reason why there is not only no gain, but an actual loss of brilliance is that the condenser fitted with the ring obviously does not fulfil the sine-condition.

Mr. E. B. Stringer's note, "On the Use of the Mercury Vapour Lamp in observing the Rings and Brushes in Crystals," was read by Dr. Hebb.

Mr. C. L. Curties said that in further illustration of this paper he had brought to the Meeting two photomicrographs to show the difference in the appearance of a crystal of calcite under the two means of illumination, by which it would be seen that with the mercury vapour lamp the rings extended quite out to the edge of the field. He also exhibited the apparatus in operation, arranged so that a crystal of calcite would be illuminated alternately by the Nernst lamp and by the mercury vapour lamp.

A communication from Mr. E. B. Miller-Williams, "On a New Fine-adjustment for Body and Substage of Microscopes," was also read by Dr. Hebb, and was illustrated by coloured drawings of the proposed device, which were passed round for inspection.

Dr. Hebb said the drawing apparently indicated an old device known as the screw-in-the-post system, but without being able to inspect a working model in action it would be unwise to pass an opinion as to the merit of the invention; still, it was very gratifying to have the benefit of seeing Mr. Miller-Williams's ingenious design even only as a schematic representation, and it was to be hoped that the inventor would see his way to exhibit later an effective working model.

Mr. Shillington Scales, in reply to the President, said he had been studying the drawing, but found it incomprehensible without explanatory notes.

Mr. C. L. Curties said he should like to defer giving an opinion on it until it had been made; but, as far as he could understand the drawing, it would be a very costly arrangement, and he did not think anyone could give an opinion on it without seeing it when made.

The President thought that, as in the case of Mr. Nelson's apparatus, it was open to any Fellow of the Society to make it.

The President said he should like to propose a vote of thanks to Messrs. Baker for the loan of the Microscopes to illustrate the subject of his paper. Also to the writers of the other papers and communications and demonstrations.

This was put to the Meeting and carried unanimously.

It was announced that the next Meeting of the Society would take place on October 19, and that the rooms of the Society would be closed from August 12 until September 12.

The following Instruments, Objects, etc., were exhibited:—

The President:—Slides of *Trochodota dunedinensis*: (1) Entire animal, and (2) Calcareous Wheels and Hoops of ditto. Presented by Mr. M. J. Allan, of Geelong.

The following Slides in illustration of his paper: *Aleyonium paessleri*, Spicules; *Ceratoisis delicatula*, Polyps; ditto, Spicules; *C. rosea*, Polyp and various specimens in fluid. Collected by Sir Ernest Shackleton's Expedition at Cape Royds.

Dr. Hebb:—Black and white Tile for Dissecting purposes; Copper Water Bath for Glycerin-jelly Mounting; Cabinet for Slides; Cloth-covered Unit, containing twelve trays holding six slides each. Sent for exhibition by Messrs. Flatters and Garnett.

Photomicrographs of Mr. Grayson's Rulings, taken by himself: Ten bands of 1000 to 10,000 lines to the inch \times 300; an enlargement of the 10,000 band \times 900, 90,000 \times 2000; and enlargements \times 6000 and \times 8000. Sent for exhibition by Mr. E. M. Nelson.

Diagrams illustrating Mr. Nelson's remarks on Mr. Grayson's photomicrographs.

Diagrams illustrating Mr. Nelson's paper.

Drawings of Mr. E. B. Millar-Williams's Fine-adjustment for Body and Substage of Microscopes.

Mr. C. L. Curties:—Calcite, polarized, illuminated by Mercury Vapour Lamp and Nernst Electric Lamp; and Photomicrographs of the appearance under each method of illumination, in illustration of Mr. E. B. Stringer's note.

New Fellows:—The following were elected *Ordinary* Fellows of the Society:—H. C. Gooding, Frank J. Keeley, F. G. Millar, and T. Chalkley Palmer.

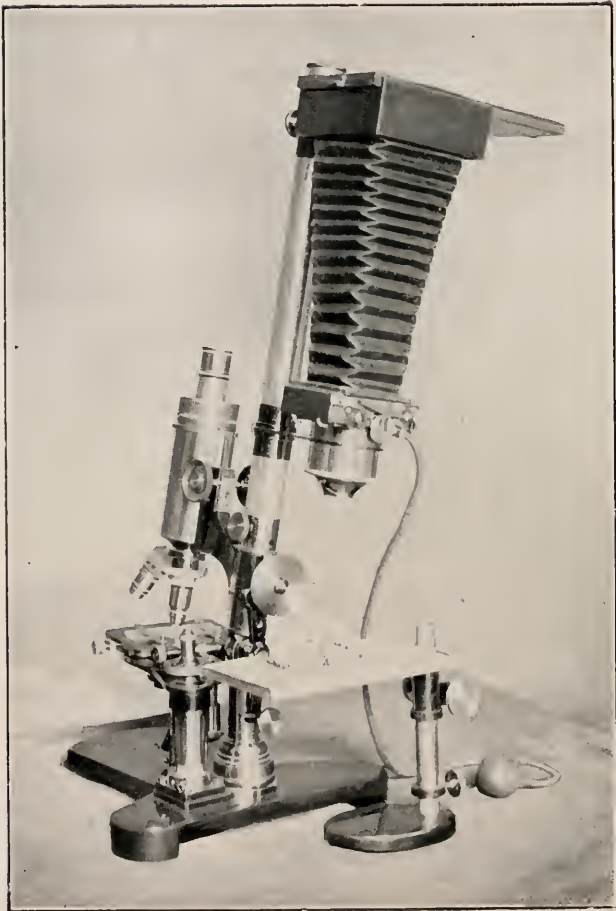

JOURNAL

OF THE

ROYAL MICROSCOPICAL SOCIETY.

OCTOBER, 1910.

TRANSACTIONS OF THE SOCIETY.

XIII.—*Comparative Micrometric Measurements.*

By DR. MARSHALL D. EWELL, Chicago, Illinois.

(Read May 25, 1910.)

THE measurements recorded in this paper were made at the suggestion of the writer by Mr. Frank J. Keeley, of Philadelphia, who is widely known as an accomplished microscopist, and by the writer, with the view of ascertaining how nearly independent measurements of the same spaces under different conditions would agree, and the probable accuracy to be attained in such measurements with medium and high powers.

The results are recorded to the second decimal place, not because confidence is felt in so high a degree of accuracy, but in order better to compare results. Upon this subject Mr. Keeley, in a letter to the writer, stated in substance that if we accept 0.1μ as the limit of accuracy in micrometry, it would seem useless to record decimals beyond the nearest 0.1μ ; and while this is probably good practice in giving measurements of various objects, with the above understanding it does no harm in the comparison of micrometers to use a larger number. Four or five decimals may well be used in stating the value of one division of the filar micrometer, when such value has been determined by taking the mean of many readings.

In 1889 the writer touched upon this subject in a paper published in the Proceedings of the American Society of Microscopists for that year, on pages 64 to 66. The measurements there recorded were made in 1885 and 1889, with powers varying from a $\frac{1}{4}$ -in. dry objective, in which one division of the filar micrometer equalled 0.126μ , to a $\frac{1}{25}$ -in. homogeneous immersion objective,

with which one division of the filar micrometer equalled 0.0256μ . The results given below are the mean of six (6) series of measurements by the writer, and of an unknown number made by Professor Pearce, of the U.S. Coast and Geodetic Survey, in 1882—with what instruments is to the writer unknown. It is perhaps unnecessary to add that none of these measurements were made with a view to comparison of the results. Micrometer measured, "Centimeter A, 1882."

Space.	Corrections		Mean of both Series	Difference from Mean	
	Pearce, 1882	Ewell, 1885 and 1889		Pearce	Ewell
$\frac{1}{100}$ mm.	μ	μ	μ	μ	μ
1st	- 0.08
2nd	+ 0.34	+ 0.36	+ 0.35	+ 0.01	- 0.01
3rd	+ 0.05	+ 0.02	+ 0.03	- 0.02	+ 0.01
4th	+ 0.09	+ 0.06	+ 0.07	- 0.02	+ 0.01
5th	- 0.41	- 0.42	- 0.41	0.00	+ 0.01
6th	+ 0.20	+ 0.18	+ 0.19	- 0.01	+ 0.01
7th	+ 0.39	+ 0.29	+ 0.34	- 0.05	+ 0.05
8th	- 0.19	- 0.19	- 0.19	0.00	0.00
9th	- 0.05	- 0.08	- 0.06	- 0.01	+ 0.02
10th	+ 0.20	+ 0.16	+ 0.18	- 0.02	+ 0.02
11th	- 0.18	- 0.19	- 0.18	0.00	+ 0.01
12th	+ 0.23

The agreement between these two series of independent measurements is close, the greatest difference being only 0.1μ or 0.05μ from the mean of the two. The writer there stated that the use of high powers in micrometry does not give so great an advantage as had been claimed by some writers, and that clearness of definition is of more importance than high amplification. The results of the measurements here recorded confirm the writer in that opinion. Neither is high angular aperture of great importance, at least not in the comparison of micrometers.

The measurements made by Mr. Keeley and the writer were made on a Powell and Lealand glass stage-micrometer, being the same scale described as "Powell and Lealand No. VIII." in a paper by the writer published in this Journal for 1908, pp. 686 and 689. The lines of this scale are fine, well filled, and sealed in with balsam and a cover-glass, and are reasonably well adapted to the making of accurate measurements, with transmitted light—which was used throughout. Mr. Keeley used artificial light and the writer daylight. In it one millimetre is divided into tenths, and the first tenth into hundredths of a millimetre.

In order to avoid any insensible bias, the figures recorded in the said paper were not consulted until after all the other measurements had been made and recorded.

The instruments used by Mr. Keeley in measuring the 0.1 mm. spaces were a Zentmayer Centennial Stand (which is an instrument of very great weight and unusual stability), a Zentmayer filar

micrometer (using one fixed wire and one parallel movable wire, and pitch of screw $\frac{1}{70}$ in.), a Tolles $\frac{6}{10}$ -in. objective of 0.42 N.A., and a Bicknell achromatic condenser diaphragmed to about one-half the aperture of the objective. With this combination one division of the filar micrometer equals 0.26289 μ .

Forty readings were made at each end of each space, and the mean only is recorded.

The instruments used by the writer on the 0.1 mm. spaces were a Spencer stand (of excellent construction, but of moderate weight), a Zeiss filar micrometer (pitch of the screw, $\frac{1}{4}$ mm.), and a Leitz No. 3 objective, of 18 mm. equivalent focus and 0.28 N.A. One division of the filar micrometer with this combination equals 0.169 μ . Ten readings were made at each end of each space measured. The results of the measurements by the writer were as follows:—

Space	No. Divisions	Relative Corrections		Remarks
		Divisions	Microns	
$\frac{1}{10}$ mm.				
1st	578.1	+ 4.1	+ 0.69	Ten readings on each end of each space.
2nd	588.0	- 5.8	- 0.98	
3rd	576.7	+ 5.5	+ 0.93	
4th	585.3	- 3.1	- 0.52	
5th	582.9	- 0.7	- 0.12	
Mean ..	582.2			

The results of Mr. Keeley's measurements were as follows:—

Space	No. Divisions	Relative Corrections		Remarks
		Divisions	Microns	
$\frac{1}{10}$ mm.				
1st	377.0	+ 2.8	+ 0.74	Forty readings on each end of each space.
2nd	383.6	- 3.8	- 1.00	
3rd	376.2	+ 3.6	+ 0.96	
4th	381.9	- 2.1	- 0.56	
5th	380.3	- 0.5	- 0.13	
Mean ..	379.8			

Combining the above results, giving them the weights 1 and 4 respectively, that being the ratio of the square roots of the number of observations respectively, we have the following as the relative corrections:—

Space	Corrections
$\frac{1}{10}$ mm.	
1st	+ 0.73
2nd	- 1.00
3rd	+ 0.95
4th	- 0.55
5th	- 0.13

In order to compare these results to advantage, they are repeated in parallel columns:—

Space	Corrections		Weighted Mean	Differences from Mean	
	Ewell	Keeley		Ewell	Keeley
$\frac{1}{10}$ mm.					
1st	+ 0·69	+ 0·74	+ 0·73	+ 0·04	- 0·01
2nd	- 0·98	- 1·00	- 1·00	- 0·02	0·00
3rd	+ 0·93	+ 0·96	+ 0·95	+ 0·02	- 0·01
4th	- 0·52	- 0·56	- 0·55	- 0·03	+ 0·01
5th	- 0·12	- 0·13	- 0·13	- 0·01	0·00

The differences in these results are quite insensible.

The instruments used by Mr. Keeley in measuring the two $\frac{5}{100}$ -mm. spaces of the first $\frac{1}{10}$ mm. were the same as above stated, except that a Tolles $\frac{1}{3}$ -in. objective was used. With this combination, one division of the filar micrometer equals 0·1702 μ . Thirty readings were made on each end of each space, with the following results:—

Space	Divisions	Relative Corrections	
		Divisions	Microns
$\frac{5}{100}$ mm.			
1st	289·80	+ 1·25	+ 0·21
2nd	292·30	- 1·25	- 0·21
Mean	291·05		

The same spaces were measured in 1907 by the writer, using the Spencer stand, Zeiss filar, and the Leitz No. 3 objective before described. With this combination, one division of the micrometer equals 0·169 μ . Ten readings were made on each end of each space.

Again, in 1909, using a Spencer stand, a Leitz No. 5 objective, of 5·8 mm. focal length and 0·77 N.A., and a Gaertner filar micrometer (pitch of screw, $\frac{1}{4}$ mm.), thirty readings more were made on each end of each space. With this combination, one division of the micrometer equals 0·067 μ .

Combining these two series of ten and thirty readings by the writer, we have the following results:—

Space	Relative Corrections
$\frac{5}{100}$ mm.	
1st	+ 0·23
2nd	- 0·23

Combining these results with those obtained by Mr. Keeley, we have the following:—

Space	Relative Corrections. Both Series	Differences from Mean	
		Keeley	Ewell
$\frac{5}{100}$ mm.			
1st	+ 0.22	+ 0.01	- 0.01
2nd	- 0.22	- 0.01	+ 0.01

These differences are also quite insensible.

The first $\frac{5}{100}$ mm. spaces of the first $\frac{1}{10}$ mm. were next measured by Mr. Keeley, using the same instruments, except that a $\frac{1}{5}$ -in. Wales water-immersion objective of 1.03 N.A. was used instead of a lower power. With this combination, one division of the filar micrometer equals 0.03645 μ . Thirty readings were made on each end of each space, with the following results:—

Space	No. Divisions	Relative Corrections	
		Divisions	Microns
$\frac{1}{100}$ mm.			
1st	268.7	+ 1.9	+ 0.07
2nd	272.3	- 1.7	- 0.06
3rd	270.6	0.0	0.00
4th	268.9	+ 1.7	+ 0.07
5th	272.5	- 1.9	- 0.06
Mean	270.6		

The same spaces were measured by the writer in 1908, using the Spencer stand, Zeiss filar, and a Spencer 4 mm. objective of 0.65 N.A. With this combination one division of the filar micrometer equals 0.0388 μ . Ten readings were made on each end of each space, with the following results:—

Space	No. Divisions Micrometer	Relative Corrections	
		Divisions	Microns
$\frac{1}{100}$ mm.			
1st	252.7	+ 1.7	+ 0.07
2nd	254.4	0.0	0.00
3rd	254.0	+ 0.4	+ 0.02
4th	251.7	+ 2.7	+ 0.11
5th	259.3	- 4.9	- 0.19
Mean	254.4		

The same spaces were again measured in 1909 by the writer, using a Spencer stand, the 4 mm. Spencer objective, and a Gaertner

filar micrometer with an invar screw having a pitch of $\frac{1}{4}$ mm. With this combination one division of the micrometer equals $0\cdot04725 \mu$. Twenty readings were made on each end of each space, with the following results :—

Space	No. Divisions	Relative Corrections	
		Divisions	Microns
$\frac{1}{10}$ mm.			
1st	207·3	+ 1·5	+ 0·07
2nd	210·2	- 1·4	- 0·06
3rd	209·3	- 0·5	- 0·02
4th	207·3	+ 1·5	+ 0·07
5th	210·0	- 1·2	- 0·06
Mean	208·8		

The arithmetical mean of the corrections arising from these thirty measurements by the writer is as follows :—

Space	Mean 30 Readings
$\frac{1}{10}$ mm.	
1st	+ μ 0·07
2nd	- 0·04
3rd	- 0·01
4th	+ 0·08
5th	- 0·10

Finally, combining the results of the measurements by Mr. Keeley and the writer, as above recorded, giving them equal weights, we have :—

Space	Relative Corrections. Mean Keeley and Ewell. Equal Weights	Differences from Mean	
		Keeley	Ewell
$\frac{1}{10}$ mm.			
1st	+ 0·07	μ 0·00	μ 0·00
2nd	- 0·05	+ 0·01	- 0·01
3rd	0·00	0·00	+ 0·01
4th	+ 0·07	0·00	- 0·01
5th	- 0·08	- 0·02	+ 0·02

These differences are again insensible.

From a series of sixteen comparisons, comprising eighty readings on each end of the first $\frac{1}{10}$ mm. of "Powell and Lealand No. VIII.," with the mean of 400 readings on the first five $\frac{1}{10}$ mm. of "Zeiss No. II.," a glass millimetre ruled similarly to "Powell and Lealand No. VIII.," which ("Z. II.") in turn had been carefully compared

with the first millimetre of an invar decimeter, the corrections of which are derived from both the National Bureau of Standards and the International Bureau of Weights and Measures, we have the absolute correction of the first $\frac{1}{10}$ mm. of "Powell and Lealand No. VIII." = $+0.9 \mu$ or $+0.45 \mu$ on each $\frac{5}{100}$ mm., composing the said $\frac{1}{10}$ mm. After applying all corrections, the first $\frac{5}{100}$ mm. of "Powell and Lealand No. VIII." therefore equals 49.33μ , and the second $\frac{5}{100}$ mm. equals 49.77μ . The said corrections are respectively $+0.22 \mu + 0.45 \mu = +0.67 \mu$ and $-0.22 \mu + 0.45 \mu = +0.23 \mu$.

The total correction of the first $\frac{5}{100}$ mm. of "Powell and Lealand No. VIII." being $+0.67 \mu$, the absolute corrections for each $\frac{1}{100}$ mm. composing this space is $+0.13 \mu$. Applying both the relative and the absolute corrections to each $\frac{1}{100}$ mm. space, we have finally:—

Space	Relative Correction	Absolute Correction	Total Corrections	Length
$\frac{1}{100}$ mm.				
1st	$+0.07$	$+0.13$	$+0.20$	9.80
2nd	-0.05	$+0.13$	$+0.08$	9.92
3rd	0.00	$+0.13$	$+0.13$	9.87
4th	$+0.07$	$+0.13$	$+0.20$	9.80
5th	-0.08	$+0.13$	$+0.05$	9.95

The methods adopted by the writer are quite different from those adopted by Mr. Keeley. It has been the practice of the writer, when the unit measured is small enough not to occupy more than about one-third of the field, which, or even less, with ordinary objectives is about the limit, to traverse the whole space measured with the movable wire, taking the difference between the initial and terminal readings, and always using the same part of the screw. Practically the same results have been obtained by the writer using a single web, two webs crossing at an acute angle, and two parallel wires, the space between them being bisected by the defining lines. The last is, in the writer's experience, much more convenient than the other two, and obviates any error incident to the use of one line only where the two defining lines are of unequal thickness. The fixed wire is used simply to be certain that the space being measured has not moved during the process of measurement.

Mr. Keeley's method is radically different. It will be described, using his own language:—"All measurements are made between the fixed and movable wires in the filar micrometer. The fixed wire is placed about two turns of the screw to the right of the centre of the field and adjusted by set screws, so that when the movable wire is exactly over it, the drum reads zero. As it is

impossible to determine when the two wires are exactly superimposed, I make from time to time a number of readings on each side of the fixed wire to determine the zero error, which in my Zentmayer filar is at present one-half division (minus). In measuring an object such as a blood corpuscle, I enclose it between the inner margins of the two wires; hence the diameter of one wire (or half the sum of the diameters of the two wires, which is the same thing) must be allowed for: this is equal to two divisions." So that the total correction in such case would be -2.5 divisions.

In making measurements upon a stage micrometer, the wires are both placed parallel to the two defining lines of the stage micrometer, and on the left side thereof, respectively. Where these defining lines are both of the same thickness, all that is now necessary is to apply the correction for zero error to the reading. If, however, the defining lines are of different thicknesses, in order to make the two methods used in this work comparable, it is necessary to measure from centre to centre of the defining lines. An equal number of readings are, therefore, made on both sides of the two defining lines, and the mean of the two sets of readings taken, which eliminates the effect of unequal thickness of the two defining lines, and gives the reading from centre to centre.

By Mr. Keeley's method, it will be observed that two readings are made, one on each side of each defining line, and the mean adopted as the final reading. This method is more laborious, but the recorded results show that it yields a very high degree of accuracy.

In order to give some idea of the precision of the results obtained, from ten to twenty readings are given in each series, with the resulting probable error, computed in the usual manner.

Using a Spencer stand (new model), Gaertner filar micrometer, with a Leitz No. 3 objective, the following readings were obtained on the first $\frac{1}{10}$ mm. of the micrometer under observation. One division = 0.2073μ .

Space. 1st $\frac{1}{10}$ mm.	Divisions	Differences from Mean	Same Squared
No. Reading 1	474.9	div. - 0.85	0.72
" 2	473.7	+ 0.35	0.12
" 3	473.5	+ 0.55	0.30
" 4	474.2	- 0.15	0.02
" 5	473.6	+ 0.45	0.20
" 6	473.7	+ 0.35	0.12
" 7	474.0	+ 0.05	0.00
" 8	474.0	+ 0.05	0.00
" 9	474.4	- 0.35	0.12
" 10	474.5	- 0.45	0.20
Mean	474.05		$\Sigma [v^2] = 1.82$

Using the formulæ—

$$r = 0.6745 \sqrt{\frac{\sum [v^2]}{n-1}}$$

and

$$r_0 = 0.6745 \sqrt{\frac{\sum [v^2]}{n(n-1)}}$$

in which

$$\sum [v^2] = 1.82$$

we have

$$r = \pm 0.3 \text{ div.} = \pm 0.06 \mu$$

$$r_0 = \pm 0.1 \text{ div.} = \pm 0.02 \mu$$

Using the No. 5 Leitz objective (with which one division equals 0.067μ), on the first $\frac{5}{100}$ mm. of the first $\frac{1}{10}$ mm., we have the following:—

Space. 1st $\frac{5}{100}$ mm.		Readings. Divisions	Differences from Mean	Same Squared
No.	Reading	1	+ 1.89	3.57
"	2	734.7	+ 1.19	1.42
"	3	733.4	+ 2.49	6.20
"	4	736.3	- 0.41	0.17
"	5	735.1	+ 0.79	0.62
"	6	736.7	- 0.81	0.66
"	7	735.8	+ 0.09	0.01
"	8	735.9	- 0.01	0.00
"	9	736.3	- 0.41	0.17
"	10	738.3	- 2.41	0.17
"	11	736.2	- 0.31	0.10
"	12	735.0	+ 0.89	0.79
"	13	737.6	- 1.71	2.92
"	14	736.9	- 1.01	1.02
"	15	736.9	- 1.01	1.02
"	16	736.3	- 0.41	0.17
"	17	735.3	+ 0.59	0.35
"	18	735.7	+ 0.19	0.04
"	19	734.5	+ 1.39	1.93
"	20	736.9	- 1.01	1.02
Mean	735.89		$\sum [v^2] = 22.34$

$$r = \pm 0.7 \text{ div.} = \pm 0.05 \mu$$

$$r_0 = \pm 0.16 \text{ div.} = \pm 0.01 \mu$$

Using the Spencer $\frac{1}{4}$ mm. objective, with which one division = 0.047μ on the first $\frac{1}{100}$ mm. we have:—

Space. 1st $\frac{1}{100}$ mm.	Divisions	Differences from Mean	Same Squared
No. Reading 1	205.1	+ 2.23	4.97
" 2	207.1	+ 0.23	0.05
" 3	207.1	+ 0.23	0.05
" 4	209.4	- 2.07	4.28
" 5	205.4	+ 1.93	3.72
" 6	208.3	- 0.97	0.94
" 7	207.9	- 0.57	0.32
" 8	207.2	+ 0.13	0.02
" 9	204.5	+ 2.83	8.01
" 10	205.0	+ 2.33	5.43
" 11	206.2	+ 1.13	1.28
" 12	206.9	+ 0.43	0.18
" 13	206.6	+ 0.73	0.53
" 14	207.6	- 0.27	0.07
" 15	207.6	- 0.27	0.07
" 16	203.5	- 1.17	1.37
" 17	209.5	- 2.17	4.71
" 18	206.4	+ 0.93	0.86
" 19	209.5	- 2.17	4.71
" 20	210.7	- 3.37	11.36
Mean	207.33		$\Sigma [v^2] = 52.96$

$$r = \pm 1.13 \text{ div.} = \pm 0.05 \mu$$

$$r_0 = \pm 0.25 \text{ div.} = \pm 0.01 \mu$$

As before stated, Mr. Keeley's method requires two readings on each side of each defining line to make a complete observation. Below are given ten complete observations on the first $\frac{1}{10}$ mm., using the $\frac{6}{10}$ Tolles objective, with which one division = 0.263μ :—

Space. 1st $\frac{1}{10}$ mm.		Mean Right and Left	Differences from Mean	Differences Squared
Left	Right			
376.9	376.6	376.7	+ 0.14	0.02
376.8	376.5	376.6	+ 0.24	0.06
376.6	377.0	376.8	+ 0.04	0.00
376.9	376.5	376.7	+ 0.14	0.02
376.6	376.6	376.6	+ 0.24	0.06
377.2	376.6	376.9	- 0.06	0.00
377.4	376.9	377.1	- 0.26	0.07
377.0	377.1	377.0	- 0.16	0.03
376.9	376.7	376.8	+ 0.04	0.00
377.3	377.2	377.2	- 0.36	0.13
Mean		376.84		$\Sigma [v^2] = 0.38$

$$r = \pm 0.14 \text{ div.} = \pm 0.04 \mu$$

$$r_0 = \pm 0.04 \text{ div.} = \pm 0.01 \mu$$

The following are ten complete measurements by Mr. Keeley on the first $\frac{5}{100}$ mm., using the $\frac{1}{3}$ Tolles objective, with which one division equals 0.17μ :—

Space. $1st \frac{5}{100}$ mm.		Mean Right and Left	Differences from Mean	Differences Squared
Left	Right			
290.0	289.5	289.7	+ 0.22	0.05
290.6	289.3	289.9	+ 0.02	0.00
290.3	289.5	289.9	+ 0.02	0.00
290.3	289.2	289.8	+ 0.12	0.01
290.0	289.7	289.8	+ 0.12	0.01
289.9	289.6	289.7	+ 0.22	0.05
290.5	289.7	290.1	- 0.18	0.03
291.0	289.6	290.3	- 0.38	0.14
291.0	289.0	290.0	- 0.08	0.01
290.3	289.7	290.0	- 0.08	0.01
Mean		289.92		$\Sigma [v^2] = 0.32$

$$r = \pm 0.13 \text{ div.} = \pm 0.02 \mu$$

$$r_0 = \pm 0.04 \text{ div.} = \pm 0.007 \mu$$

The following are a series of ten complete measurements on the first $\frac{1}{100}$ mm., using the $\frac{1}{5}$ Wales objective, with which one division equals 0.03645μ :—

Space. $\frac{1}{100}$ mm.		Mean Right and Left	Differences from Mean	Differences Squared
Left	Right			
270.2	267.5	268.8	+ 0.2	0.04
269.4	267.0	268.2	+ 0.8	0.64
270.0	267.9	268.9	+ 0.1	0.01
270.0	268.9	269.4	- 0.4	0.16
269.8	268.8	269.3	- 0.3	0.09
270.6	267.9	269.2	- 0.2	0.04
269.2	267.9	268.5	+ 0.5	0.25
270.6	267.7	269.1	- 0.1	0.01
270.9	268.5	269.7	- 0.7	0.49
270.4	267.3	268.8	+ 0.2	0.04
Mean		269.0		1.77

$$r = \pm 0.3 \text{ div.} = \pm 0.01 \mu$$

$$r_0 = \pm 0.09 \text{ div.} = \pm 0.003 \mu$$

The probable errors both of a single observation and of the arithmetical mean furnish no indication whatever of the existence or non-existence of constant errors involved in the measurements, and have been here computed simply because that is the customary practice in measurements of precision, and as an easy means of

comparing observations made by different observers. Constant errors have been eliminated as far as possible, and every measurement was made independently and without any knowledge of the results reached by the other observer. Indeed, the substantial agreement of the results was not established until the preparation of this paper.

Writing in 1878 upon this subject, the late Professor William A. Rogers used the following language :—“ A simple and direct way to determine the degree of precision with which measures under the microscope may be made, is to compare measurements of the same space made by different observers and under different conditions. I may get results which show an agreement *inter se* quite within the limits of the accuracy required, but which are yet wide of the truth. But if another equally skilful observer obtains substantially the same results from a series of measurements made under entirely different conditions, the inference of their general correctness may be drawn with tolerable safety.” (See Proceedings American Academy of Arts and Sciences, 1878, p. 178.)

The powers used in the series of measurements recorded in the paper just referred to were 194, 290, 560, and 870 ; but the relative accuracy of measurements of the same space with different powers is not discussed in the paper above referred to, though reference is made to the accuracy attained by the use of other different measuring appliances.

In order, if possible, to throw further light upon this topic, the writer has measured the same space, the first $\frac{1}{100}$ mm. of “ Powell and Lealand, No. VIII.,” with the Spencer stand and Gaertner filar micrometer already described, using in succession the following objectives : an 8 mm. Bausch and Lomb objective, N.A. 0·50 ; a No. 5 Leitz objective of 5·8 mm. focal length and 0·77 N.A. ; a Spencer 4 mm. objective of 0·66 N.A. ; a 2 mm. Himmler homogeneous immersion objective of 1·30 N.A. ; and a Zeiss $\frac{1}{8}$ -in. homogeneous immersion objective of 1·27 N.A.

The only change made in the apparatus from beginning to end of these measurements, except as noted below, was in the objectives, which were used in the order mentioned. The surrounding conditions were maintained unchanged as nearly as possible, so that the variation in the degree of accuracy developed, should there be such variation, might be attributed solely to the change of objectives. Of course the personal factor enters into the result, but there was no conscious change in this respect. The readings are given in detail and are as follows :—

Instruments : Spencer new stand, No. 22, with mechanical stage and achromatic condenser ; Gaertner filar micrometer, with an invar screw having a pitch of $\frac{1}{4}$ mm. and two movable parallel spider lines, as before described ; and the Bausch and Lomb 8 mm. objective above described.

With this combination one division of the micrometer equals 0.10175μ . Every measurement was made upon the first $\frac{1}{100}$ mm. of "Powell and Lealand No. VIII.," Book W, p. 79.

No.	Reading	Difference from Mean	Same Squared
	div.	div.	
1	97.3	- 0.4	0.16
2	96.4	+ 0.5	0.25
3	96.5	+ 0.4	0.16
4	96.8	+ 0.1	0.01
5	96.6	+ 0.3	0.09
6	96.7	+ 0.2	0.04
7	98.1	- 1.2	1.44
8	96.9	0.0	0.00
9	96.1	+ 0.8	0.64
10	97.6	- 0.7	0.49
Mean	96.9	Arith. Sum = 4.6	$\Sigma [v^2] = 3.28$

$$r = \pm 0.4 \text{ div.} = \pm 0.04 \mu$$

$$r_0 = \pm 0.1 \text{ div.} = \pm 0.01 \mu$$

Average deviation from mean without regard to sign = $0.46 \text{ div.} = 0.05 \mu$.

Greatest deviation from mean = $1.2 \text{ div.} = 0.12 \mu$.

The same instruments, except No. 5 Leitz objective, one division = 0.067μ . Book W, p. 79.

No.	Reading	Differences from Mean	Same Squared
	div.	div.	
1	146.5	+ 0.8	0.64
2	147.7	- 0.4	0.16
3	147.7	- 0.4	0.16
4	147.9	- 0.6	0.36
5	146.0	+ 1.3	1.69
6	148.1	- 0.8	0.64
7	147.5	- 0.2	0.04
8	147.0	+ 0.3	0.09
9	147.5	- 0.2	0.04
10	147.2	+ 0.1	0.01
Mean	147.3	Arith. Sum = 5.1	$\Sigma [v^2] = 3.88$

$$r = \pm 0.44 \text{ div.} = \pm 0.03 \mu$$

$$r_0 = \pm 0.14 \text{ div.} = \pm 0.01 \mu$$

Average deviation from mean = $0.5 \text{ div.} = 0.03 \mu$.

Greatest deviation from mean = $1.3 \text{ div.} = 0.09 \mu$.

The same instruments, except 4 mm. Spencer objective; one division equals 0.04725μ . Book W, p. 80.

No.	Readings	Differences from Mean	Same Squared
	div.	div.	
1	206·0	+ 1·0	1·00
2	206·0	+ 1·0	1·00
3	207·0	0·0	0·00
4	206·7	+ 0·3	0·09
5	207·0	+ 0·0	0·00
6	207·7	- 0·7	0·49
7	207·0	0·0	0·00
8	207·4	- 0·4	0·16
9	207·5	- 0·5	0·25
10	207·8	- 0·8	0·64
Mean	207·0	Arith. Sum = 4·7	$\Sigma [v^2] = 3·63$

$$r = \pm 0·4 \text{ div.} = \pm 0·02 \mu$$

$$r_0 = \pm 0·1 \text{ div.} = \pm 0·007 \mu$$

Average deviation from mean = 0·5 div. = 0·2 μ .

Greatest deviation from mean = 1·0 div. = 0·05 μ .

The same instruments, except 2 mm. Himmler homogeneous immersion objective, one division = 0·02154 μ . Book W, p. 80.

No.	Reading	Differences from Mean	Same Squared
	div.	div.	
1	452·9	+ 2·1	4·41
2	454·3	+ 0·7	0·49
3	456·6	- 1·6	2·56
4	456·4	- 1·4	1·96
5	456·0	- 1·0	1·00
6	456·4	- 1·4	1·96
7	453·9	+ 1·1	1·21
8	454·5	+ 0·5	0·25
9	454·0	+ 1·0	1·00
10	454·8	+ 0·2	0·04
Mean	455·0	Arith. Sum = 11·0	$\Sigma [v^2] = 14·88$

$$r = \pm 0·9 \text{ div.} = \pm 0·02 \mu$$

$$r_0 = \pm 0·3 \text{ div.} = \pm 0·006 \mu$$

Average deviation from mean = 1·1 div. = 0·02 μ .

Greatest deviation from mean = 2·1 div. = 0·05 μ .

The same instruments, except Zeiss $\frac{1}{8}$ -in. objective, one division = 0·015 μ . Book W, p. 80.

SERIES A.

No.	Readings	Differences from Mean	Same Squared
	div.	div.	
1	647·8	- 1·24	1·54
2	647·7	- 1·14	1·30
3	646·7	- 0·14	0·02
4	648·6	- 2·04	4·16
5	647·0	- 0·44	0·19
6	646·7	- 0·14	0·02
7	648·8	+ 2·76	7·62
8	645·5	+ 1·06	1·12
9	643·5	+ 3·06	9·36
10	648·3	- 1·74	3·03
Mean	646·56	Arith. Sum = 13·76	$\Sigma [v^2] = 28·36$

$$r = \pm 1·2 \text{ div.} = \pm 0·02 \mu$$

$$r_0 = \pm 0·4 \text{ div.} = \pm 0·006 \mu$$

Average deviation from mean = 1·4 div. = 0·02 μ .

Greatest deviation from mean = 3·1 div. = 0·05 μ .

SERIES B.

No.	Reading	Differences from Mean	Same Squared
	div.	div.	
1	640·8	+ 6·8	46·65
2	645·8	+ 1·8	3·35
3	646·1	+ 1·5	3·24
4	644·3	+ 3·3	11·09
5	651·0	- 3·4	11·36
6	653·7	- 6·1	36·84
7	646·9	+ 0·7	0·53
8	650·7	- 3·1	9·42
9	651·0	- 3·4	11·36
10	646·0	+ 1·6	2·66
Mean	647·6	Arith. Sum = 31·8	$\Sigma [v^2] = 136·5$

$$r = \pm 2·6 \text{ div.} = \pm 0·04 \mu$$

$$r_0 = \pm 0·8 \text{ div.} = \pm 0·01 \mu$$

Average deviation from mean = 3·2 div. = 0·05 μ .

Greatest deviation from mean = 6·8 div. = 0·10 μ .

In the measurements with the Zeiss $\frac{1}{8}$ -in. objective the magnified image of the lines of the stage micrometer completely filled the space between the two parallel spider lines, so that it was not easy to set on the lines. The following series were therefore made with the same objective, using instead of the Gaertner filar, a Zeiss

filr micrometer in which the movable lines cross at an acute angle.

With the Zeiss $\frac{1}{8}$ -in. and Zeiss filr micrometer, one division of the micrometer = 0.01247μ . Book W, pp. 82-4.

SERIES C.

No.	Reading	Differences from Mean	Same Squared
	div.	div.	
1	789.0	- 0.56	0.31
2	791.9	- 3.46	11.97
3	787.4	+ 1.04	1.08
4	787.4	+ 1.04	1.08
5	786.7	+ 1.74	3.03
6	783.8	+ 4.64	21.53
7	789.2	- 0.76	0.58
8	792.0	- 3.56	12.67
9	788.3	+ 0.14	0.02
10	788.7	- 0.26	0.07
Mean	788.44	Arith. Sum = 17.20	$\Sigma [v^2] = 52.34$

$$r = \pm 1.6 \text{ div.} = \pm 0.02 \mu$$

$$r_0 = \pm 0.5 \text{ div.} = \pm 0.006 \mu$$

Average deviation from mean = 1.7 div. = 0.02μ .

Greatest deviation from mean = 4.6 div. = 0.06μ .

SERIES D.

No.	Reading	Differences from Mean	Same Squared
	div.	div.	
1	785.5	+ 0.92	0.85
2	792.3	- 5.88	34.57
3	788.9	- 2.48	6.15
4	781.6	+ 4.82	23.23
5	785.2	+ 1.22	1.49
6	786.3	+ 0.12	0.01
7	786.7	- 0.28	0.08
8	786.9	- 0.48	0.23
9	784.9	+ 1.52	2.31
10	785.9	+ 0.52	0.27
Mean	786.42	Arith. Sum = 18.24	$\Sigma [v^2] = 69.20$

$$r = \pm 1.9 \text{ div.} = \pm 0.02 \mu$$

$$r_0 = \pm 0.6 \text{ div.} = \pm 0.007 \mu$$

Average deviation from mean = 1.8 div. = 0.02μ .

Greatest deviation from mean = 5.9 div. = 0.07μ .

SERIES E.

No.	Readings	Differences from Mean	Same Squared
	div.	div.	
1	782.7	+ 1.95	3.80
2	784.4	+ 0.25	0.06
3	785.1	- 0.45	0.20
4	784.1	+ 0.55	0.30
5	785.4	- 0.75	0.56
6	785.6	- 0.95	0.90
7	788.2	- 3.55	12.60
8	785.4	- 0.75	0.56
9	784.1	+ 0.55	0.30
10	781.5	+ 3.15	9.92
Mean	784.65	Arith. Sum=12.90	$\Sigma [v^2] = 29.22$

$$r = \pm 1.2 \text{ div.} = \pm 0.015 \mu$$

$$r_0 = \pm 0.4 \text{ div.} = \pm 0.005 \mu$$

Average deviation from mean = 1.3 div. = 0.02 μ .

Greatest deviation from mean = 3.5 div. = 0.04 μ .

SERIES F.

No.	Reading	Differences from Mean	Same Squared
	div.	div.	
1	782.0	+ 1.35	1.82
2	782.1	+ 1.25	1.56
3	783.8	- 0.45	0.20
4	782.8	+ 0.55	0.30
5	781.6	+ 1.75	3.06
6	783.5	- 0.15	0.02
7	782.2	+ 1.15	1.32
8	785.7	- 2.35	5.52
9	785.3	- 1.95	3.80
10	784.5	- 1.15	1.32
Mean	783.35	Arith. Sum. = 12.10	$\Sigma [v^2] = 18.94$

$$r = \pm 1.0 \text{ div.} = \pm 0.01 \mu$$

$$r_0 = \pm 0.3 \text{ div.} = \pm 0.004 \mu$$

Average deviation from mean = 1.2 div. = 0.015 μ .

Greatest deviation from mean = 2.4 div. = 0.03 μ .

In order that the foregoing results may be more easily compared, they are repeated in the following summary:—*

* In the body of this paper the figures representing the probable errors, etc., have usually been rounded off to the nearest 0.1 μ or 0.01 μ ; they are, however, for purposes of comparison merely, given at times to the third decimal place.

Objective	Prob. Error (r) of single observation		Prob. Error (r_0) of Arith. Mean		Average Deviation from Mean		Greatest Deviation from Mean	
	div.	μ	div.	μ	div.	μ	div.	μ
8 mm. B. & L.								
1 div. = $0\cdot10175\mu$	$\pm 0\cdot4$	$= \pm 0\cdot04$	$\pm 0\cdot13$	$= \pm 0\cdot013$	$0\cdot46 = 0\cdot05$		$1\cdot2 = 0\cdot12$	
No. 5 Leitz.								
1 div. = $0\cdot067\mu$	$\pm 0\cdot44$	$= \pm 0\cdot03$	$\pm 0\cdot14$	$= \pm 0\cdot009$	$0\cdot51 = 0\cdot03$		$1\cdot3 = 0\cdot09$	
4 mm. Spencer								
1 div. = $0\cdot047\mu$	$\pm 0\cdot43$	$= \pm 0\cdot02$	$\pm 0\cdot14$	$= \pm 0\cdot007$	$0\cdot47 = 0\cdot02$		$1\cdot0 = 0\cdot05$	
2 mm. Himmler.								
1 div. = $0\cdot02154\mu$	$\pm 0\cdot87$	$= \pm 0\cdot02$	$\pm 0\cdot27$	$= \pm 0\cdot006$	$1\cdot1 = 0\cdot02$		$2\cdot1 = 0\cdot05$	
1/18 Zeiss; Gaertner filar.								
1 div. = $0\cdot015\mu$								
Series A	$\pm 1\cdot2$	$= \pm 0\cdot02$	$\pm 0\cdot33$	$= \pm 0\cdot006$	$1\cdot38 = 0\cdot02$		$3\cdot06 = 0\cdot05$	
Series B	$\pm 2\cdot63$	$= \pm 0\cdot04$	$\pm 0\cdot83$	$= \pm 0\cdot012$	$3\cdot18 = 0\cdot05$		$6\cdot83 = 0\cdot10$	
1/18 Zeiss; Zeiss filar.								
1 div. = $0\cdot01247\mu$								
Series C	$\pm 1\cdot63$	$= \pm 0\cdot02$	$\pm 0\cdot51$	$= \pm 0\cdot006$	$1\cdot72 = 0\cdot02$		$4\cdot64 = 0\cdot06$	
Series D	$\pm 1\cdot87$	$= \pm 0\cdot02$	$\pm 0\cdot58$	$= \pm 0\cdot007$	$1\cdot82 = 0\cdot02$		$5\cdot88 = 0\cdot07$	
Series E	$\pm 1\cdot21$	$= \pm 0\cdot02$	$\pm 0\cdot38$	$= \pm 0\cdot005$	$1\cdot29 = 0\cdot02$		$3\cdot55 = 0\cdot04$	
Series F	$\pm 0\cdot98$	$= \pm 0\cdot01$	$\pm 0\cdot30$	$= \pm 0\cdot004$	$1\cdot21 = 0\cdot02$		$2\cdot35 = 0\cdot03$	

The conclusions fairly justified by the work recorded in this paper seem to be as follows:—

1. That with experienced observers, measurements of metric spaces from $\frac{1}{100}$ mm. up to $\frac{1}{10}$ mm. may, when made in a series sufficiently large, be relied upon as accurate within limits considerably less than $0\cdot1 \mu$, probably under favourable conditions to about $0\cdot05 \mu$, though as to the correctness of this last statement the writer is not so confident as to the first.

2. That there is no advantage in the use of high powers or large numerical apertures, but in the writer's opinion a positive disadvantage if the power used is very high. In the comparison of standards from 1 millimetre up to 1 metre, the experience of the writer is that, in a series, a 1-in. objective, and in the measurements of small units, as mentioned in this paper, a 4 mm. objective, afford ample initial amplification.

Of course, if the unit measured is very small, and in a band of spaces of similar dimensions, the numerical aperture employed must be sufficient for its resolution, and the amplification sufficient to enable the setting of the wires to be accurately made, nothing further seems necessary; but such measurements do not come within the scope of this paper.

Personally the writer is of the opinion that the lowest power that will suffice to accomplish the desired result is the best; and this is believed to be the better practice.

SUMMARY OF CURRENT RESEARCHES
RELATING TO
ZOOLOGY AND BOTANY
(PRINCIPALLY INVERTEBRATA AND CRYPTOGAMIA),
MICROSCOPY, ETC.*

ZOOLOGY.

VERTEBRATA.

a. Embryology.†

Fertility and Hatching of Eggs.‡—R. Pearl and F. M. Surface publish the results of their study of the factors which influence the hatching of eggs. There is a small but still sensible correlation between the fertility and the hatching quality of eggs. In general, or on an average, the hens whose eggs run high in fertility will also tend to show a high hatching quality of eggs (percentage of fertile eggs hatched), and vice versa. Conditions of housing have a marked and definite influence on the mean fertility and hatching quality of eggs. It was found that both the fertility and hatching quality of eggs were very much better in a "curtain-front" house, which furnished an abundance of fresh, pure air, than when use was made of what was formerly thought to be a highly desirable type of heated house, without curtain-front, but with a supposed adequate system of indirect ventilation. The hatching quality of eggs is generally less variable in proportion to the mean of the character varying than is fertility. The variability in regard to both fertility and to hatching quality is markedly influenced by environmental conditions. The data obtained show that the individuality of the female bird is a very important factor in the determination of the fertility of the eggs. Different individual females have characteristic degrees of fertility of their eggs, independent (within limits) of the character of the male bird with which they are mated. The statistics also indicate that there is no relation whatever between winter egg-production and the percentage of fertile eggs produced throughout the season. But there is a distinct correlation between winter laying and the percentage of fertile eggs hatched during

* The Society are not intended to be denoted by the editorial "we," and they do not hold themselves responsible for the views of the authors of the papers noted, nor for any claim to novelty or otherwise made by them. The object of this part of the Journal is to present a summary of the papers *as actually published*, and to describe and illustrate Instruments, Apparatus, etc., which are either new or have not been previously described in this country.

† This section includes not only papers relating to Embryology properly so called, but also those dealing with Evolution, Development, Reproduction, and allied subjects.

‡ Bull. Maine Agric. Exper. Station, No. 168 (1909) pp. 105-64 (15 figs.)

the subsequent breeding season. The higher the number of winter eggs, the lower, in general, will be the number of fertile eggs hatched, and conversely.

There is apparently no marked superiority of hens over pullets in respect of breeding performance, either in regard to fertility or hatching quality of eggs. There is no indication that the fertility of eggs in the pullet year and in the second breeding year are in any way correlated, but there is a significant positive correlation between the percentage of fertile eggs hatched in the pullet year and in the second breeding year. There is no evidence that the character "fertility of eggs" (measured by percentage of infertile eggs) is in any degree or manner inherited. The character "hatching quality of eggs" (measured by percentage of eggs hatched) is definitely inherited in the female line, and probably also in the male line.

In the last part of their paper the authors discuss the theoretical import of some of the data established, such as the negative correlation between fecundity and hatching quality—that is, germinal viability or vigour. They compare this correlation with the association of high fecundity and a high rate of infant mortality (and probably also of prenatal mortality) in man, and suggest that in both cases bad conditions of housing and nutrition, along with the organic fatigue incident to the high fecundity itself, reduce the general constitutional vigour, and with it the viability of the developing germ and the growing organism.

In conclusion, some points of importance for breeders are emphasized, and the lines on which further investigation—especially in regard to preferential mating—is required, are indicated.

Reproduction in the Domestic Fowl.*—R. Pearl and M. R. Curtis describe in detail a case of incomplete hermaphroditism in the domestic fowl. The specimen was, in its external somatic characters, an antero-posterior gynandromorph. Internally, it possessed on the left side a large lobulated gland in the position and anatomical relations normal to the ovary. There was also a fully developed, normal oviduct in functional condition on the left side. On the right side of the body was a small organ in the position and anatomical relations normal to the right testis. Attached to this organ was a normal epididymis and vas deferens leading to the cloaca. Microscopical examination showed that both of the reproductive organs were in a condition of extreme degeneration. Neither spermatogenesis nor oogenesis could be found in any part of either organ.

Origin of Blood in Toad.†—Harald Mietens finds that the liver has in early stages a pronounced blood-forming function. Blood-cells and endothelial cells are formed from the elements of the hepatic primordium, but the developed organ has no such function. The blood-formation in the liver agrees histogenetically with what occurs in the medio-ventral mesodermic blood-islands. Thus the blood has an endodermic as well as a mesodermic origin.

* Biol. Bull., xvii. (1909) pp. 271-86.

† Jen. Zeitschr. Naturw., xlv. (1909) pp. 299-324 (10 figs.).

Modern Study of Heredity.*—Angel Gallardo gives a clear account of the general scope of recent researches on heredity, with particular reference to biometrical and Mendelian studies.

Experiments on Tadpoles.†—E. Goggio has made a series of remarkable experiments on toad tadpoles. Thus a larva $3-6\frac{1}{2}$ mm. in length may be cut into two parts, which continue to live and develop in the water, independently of each other, for many days. One decapitated larva lived for fifty-four days. The most striking fact is that normality of development seems to be so slightly affected by the most serious injuries.

Male Mitochondria in Fertilized Ovum.‡—Fr. Meves submits more evidence in support of his conclusion that the chondriosomes (mitochondria and chondriokonts) represent a primitive and hereditary substance in the cytoplasm. They are seen in male and female germ-cells and in all embryonic cells. They form the primordial substance for the most diverse differentiations. The chondriosomes of embryonic cells appear to be derived from both the germ-cells. Those of the male germ-cell occur as individualized components in the fertilized ovum.

b. Histology.

Development of Dentine in Mammals.§—O. Heinrich has made a study of the development of the teeth in Mammals from the earliest rudiments to the perfect teeth. He used for his investigation the embryos of pigs, sheep, dogs and cats, and compared the corresponding stages in each form. He thus summarizes the results of his investigation, which dealt specially with the development of the dentine and its relation to the fibrils in the pulp:—The fibrils grow from the connective tissue, which surrounds the primordia of the tooth, into the papillæ till they reach the epithelial layer. There their ends form a lattice-work that becomes more and more intertwined. During this time the peripheral connective-tissue cells of the tooth papilla become transformed into odontoblasts. The odontoblasts form the basal substance of the dentine which they lay down, by means of the odontoblast fibres, on the network. The fibrils are separated from their network by the odontoblast layer, and lie under the odontoblasts, within the pulp, in which they gradually disappear.

Regeneration of Bone in Birds.||—Jan Kinel removed pieces of bone from the skull, the keel and the fingers of adult pigeons, and observed the ensuing regeneration. In the case of skull it was clearly seen that the new bone developed exclusively from the adjacent periosteum and from the dura mater. Similarly in the case of the sternum, the reparation was made by the adjacent periosteum. The new growth was more intense the further the wound was from the margin. Kinel cut off a piece (15 mm. in length) from the second phalanx of the second digit,

* Las Investigaciones modernas sobre la Herencia en Biología. Cordoba, 1909, 72 pp.

† Atti Soc. Tosc. Sci. Nat. Pisa, xxv. (1909) pp. 21-58.

‡ Anat. Anzeig., xxxvi. (1910) pp. 609-14.

§ Arch. Mikr. Anat., lxxiv. (1909) pp. 781-811 (2 pls.).

|| Anat. Anzeig., xxxvi. (1910) pp. 515-21 (2 figs.).

and examined the result in twenty-three weeks. There was a new and independent piece of bone intercalated, 2 mm. in length, which the experimenter regards as supernumerary phalanx. It appeared separately in the proliferation of periosteum at the wound.

Mitochondria of Hepatic Cells.*—André Mayer, Francis Rathery, and Georges Schaeffer find that definite granulations or mitochondria occur normally in the cells of the liver, and apart from all reagents. They form a constituent part of the cells, and do not show any appreciable change in number or in aspect with different modes of treatment. They do not behave as reserve substances.

Clasmatocytes.†—F. Pardi has made a study of Ranvier's clasmatocytes in Amphibians and in Mammals. In the former they are ramified "Mastzellen," often showing fragmentation. In the latter they are quite different from "Mastzellen," and are in genetic relation with minute cells like lymphocytes which migrate from the connective-tissue.

Visible Centrosomes in Living Cells.‡—Fr. Heiderich has succeeded in seeing the centrosome in living cells from the mucous membrane of the stomach of the frog, the cat, the dog, and the horse, and in the posterior corneal epithelium of the cat. The position of the centrosome has been previously seen in living pigment cells of fishes (by Solger), in living leucocytes (by Heidenhain). The centrosome itself has been seen in living summer ova of *Mesostoma ehrenbergi* (by Bresslau) and in living blastomeres of *Ascaris* (by Boveri).

c. General.

Mimicry.§—Géza Entz, sen., publishes the third and concluding portion of his study of animal coloration. The present paper deals with mimicry, and its general conclusions may be summed up as follows. Many cases of resemblance occur not only among animals of allied races, but also among those of quite different descent. Many animals resemble portions of the bodies of other animals, other plants or parts of plants, while many plants resemble animals or parts of animals. Sometimes the resemblance is so slight that it could only deceive the most casual observer for a moment, in others it extends to the most minute details, and goes far beyond the requirements of the mimicry-theory. In many cases, indeed in the great majority, the mimicry is of no use either to the mimetic species or its model. Defenceless animals imitate others equally defenceless, aquatic animals imitate terrestrial forms, recent animals those that have long been extinct, and so on. In regard to such cases, the "mutual assurance theory," ingenious as it is, can hardly satisfy the naturalist. Even in cases of "true mimicry," in which some advantage to the mimetic species can be demonstrated, the utility of the mimetic habit has been greatly exaggerated. The whole theory rests upon the anthropomorphic conception that animals perceive and pursue their prey in exactly the same way as human beings do. If mimetic

* C.R. Soc. Biol. Paris, lxxviii. (1910) pp. 427-9.

† Atti Soc. Toscana Sci. Nat. Pisa, xxv. (1909) pp. 59-86 (2 pls.).

‡ Anat. Anzeig., xxxvi. (1910) pp. 614-18 (1 pl.).

§ Math. Naturw. Ber. Ungarn, xxv., (1909) pp. 1-94.

species, e.g., of butterflies, have survived in virtue of the mimetic habit, it is difficult to understand why other non-mimetic and non-immune species should be equally or more numerous under the same external conditions. Observation shows, too, that many species which resemble non-living objects often lose any possible advantage from the resemblance by moving at the critical moment.

That the phenomena of mimicry should have originated through natural selection the author regards as not only improbable, but inconceivable without the aid of the metaphysical conception of purposeful endeavour. He believes that recent investigation has already established that colours, markings, and forms arise in accordance with definite laws working of necessity, without exception, and with no reference to utility. The markings on the wings of grasshoppers, praying mantises and the like, are due to innate constitutional causes, and their resemblance to sticks, leaves, etc., seem to him simply a phenomenon of convergence. Further study and more definite experiment are required, but, if these are to lead to a deeper understanding of the evolution of colour and markings, they must be untrammelled by the preconceptions of the popular theory of mimicry.

Reactions of Amphibians to Light.*—A. S. Pearse has made an experimental study of the reactions of Amphibians to light, with the view of ascertaining more fully the photoreceptors involved, and determining the part played by the central nervous system in these reactions. The following Amphibians were found to be positively phototropic: *Diemictylus viridescens*, *Rana clamata*, *R. palustris*, *Bufo fowleri*, *B. americanus*; and the negatively phototropic species studied were: *Necturus maculosus*, *Cryptobranchus allegheniensis*, *Amblystoma punctatum*, *Plethodon cinereus*. Most of these species, after removal of their eyes, gave photic responses which were like those of normal individuals. The photic reactions of eyeless Amphibians are not due to the direct stimulation of the central nervous system or the exposed ends of the optic nerves by light, but to the action of the skin as a photoreceptor. Mechanical stimulation (handling) does not change the character of the photic reactions, though it makes them more evident by inducing locomotion.

Toads which are stimulated by light through the eyes alone, react in the same manner as individuals stimulated through the skin, or through both the skin and the eyes. The movements of eyeless toads, stimulated unilaterally by light from above, are toward the illuminated side; and toads stimulated through one eye only from in front do not go toward the light, but turn towards the illuminated side. The photic reactions are therefore due to differences in light intensity on the two sides of the body, and the direction of the rays is ineffective. After the eyes had been removed, *Cryptobranchus* and *Necturus* were most responsive when the tail was illuminated, but the skin of the toad is apparently of equal sensitiveness in all parts of the body. A prolonged period passed in light or darkness had no effect on the phototropic responses of the toad. *Cryptobranchus* is strongly photokinetic, but in the other Amphibians tested, this quality was not strongly developed.

* Proc. Amer. Acad., xlv. (1910) pp. 161-208 (7 figs.).

When normal Amphibians were used, blue light was the most effective in the production of tropic responses, but when eyeless individuals were tested with the same coloured lights, the rays towards the blue end of the spectrum showed no such potency as those near the opposite end. It may be said that while both skin and eyes are sensitive to the whole range of the visible spectrum, colour-sensitiveness is present only in the latter. It is possible, however, that the supposed colour-sensitiveness is due to the effects of what are intensity-differences to the Amphibian eye. A decrease in the intensity of light brings about a correspondingly smaller number of positively phototropic responses, and an increase in the number of indifferent reactions. The phototropic responses of eyeless toads are not due to the stimulation of heat-receiving organs in the skin. Thermo- and photo-reception are separate processes, and the former does not readily give rise to tropic reactions. "Spinal" Amphibians—in which the cord is severed from the brain—gave no photic responses, but such reactions were induced in animals in which the brain anterior to the metencephalon had been excised.

Cumulative Effect of Selection.* — R. Pearl and F. M. Surface examine the results gained during the course of eleven years' experimenting with poultry, with a view to determining whether these indicate that there is a cumulative effect of selection. The data discussed were obtained from two lines of work. On the first of these, hens were selected throughout a period of nine years for high egg production. No hens were used as breeders whose production in the pullet year had not been 160 or more eggs. The cockerels used were, after the first year of the experiment, invariably the sons of mothers producing 200 or more eggs in their pullet year. Secondly, the inheritance of egg production from mother to daughter was directly measured. Records of the pullet year of egg production of 250 daughters of hens, laying 200 or more eggs in their (the mothers') pullet year, were obtained. It was found that selection for high egg production throughout nine years did not sensibly increase the average production of the flocks, or lead to any decrease in the variability of egg production. The data give no evidence that there is a sensible correlation between mother and daughter in regard to egg production, or that fecundity is sensibly inherited. The daughters of the "200-egg" hens did not exhibit, when kept under the same environmental conditions, such a high average of egg production as did pullets of the same age which were the daughters of birds whose production was less than 200 eggs per year. The daughters of "200-egg" hens were not less variable in respect to egg production than were similar birds whose mothers were not so closely selected.

In general, the authors are strongly inclined to the view that the existing evidence indicates that the superior egg-production of present-day races of domestic poultry is, in the main, the result of the action of the favourable environmental conditions included in the process of domestication rather than the effect of the selection of favourable fluctuating variations through a long period of time.

* *Zeitschr. Indukt. Abstammungs und Vererbungslehre*, ii. (1909) pp. 257-75.

Expressions of the Emotions in Pigeons.*—W. Craig publishes a paper, the first of a series, on the expression of the emotions in pigeons, the blond ring-dove being the species chosen for this study. The expression of fear, the alarm note, the "kah," or social call, and the "coo," with its various modifications as song or nest call, are described in detail, and, wherever possible, are illustrated by musical notes. Then follows a sketch of the life-cycle of the bird, and of the first occurrence of the different notes in the young bird, and their development in accordance with the growth of the vocal organs and the development of the nervous system.

Brain of American Alligator.†—A. M. Reese continues his researches on the development of the brain of the American alligator, and gives an account of the paraphysis and hypophysis, based on material collected by him in Central America. His results are as follows: The paraphysis in the alligator has long been mistaken for the epiphysis, which latter structure is entirely absent. The paraphysis is first seen in embryos of 7 mm. in length, as a wide evagination of the roof of the forebrain, to the anterior end of the transverse velum. This evagination early becomes partially constricted off from the brain, and forms a rounded, hollow mass connected by a wide stalk with the diencephalon. As growth proceeds, the paraphysis becomes elongated, until, in embryos of 7 cm. in length, it is seen as a tubular structure, with nearly smooth walls slightly curved away from the cerebral hemispheres and over the top of the diencephalon. In embryos of 13 cm. the paraphysis has practically the same structure as the 7 cm. embryo. The velum grows forward into each lateral ventricle to form its choroid plexus.

The hypophysis in the alligator begins, at about the same stage as the paraphysis, as a single median evagination of the roof of the mouth, just beneath the floor of the infundibulum. The original evagination becomes the stalk of a considerably branched, hollow structure, which, by the lengthening of the stalk, recedes to some distance from the roof of the mouth. The stalk becomes solid, and finally loses all connexion with the oral epithelium. The body of the hypophysis also becomes almost completely solid in an embryo of 13 cm., and is seen as a lobulated mass of lymphoid tissue lying close under the floor of the infundibulum.

Digestion in Marine Invertebrates.‡—H. E. Roaf has made experiments to investigate the presence of acid or alkali, during digestion, in the intestine of marine Invertebrates. He has also made some observations on the habits of the animals studied.

In *Actinoloba dianthus* the reaction of the tentacles is practically neutral. The mesenteric filaments show a more acid condition. A case of partial fission was studied, and it was found that the two individuals, although structurally united, were physiologically independent.

The food of sea-urchins near Port Erin is chiefly composed of barnacles, but seaweed is also found in the intestine. During feeding the pedicellariæ, spines, and tube-feet all participate in conveying food

* Journ. Comp. Neurol. and Psychol., xix. (1909) pp. 29-80.

† Smithsonian Misc. Coll., liv. No. 1922 (1910) pp. 1-20 (5 pls.).

‡ Journ. Physiol., xxxix. (1910) pp. 438-52.

to the mouth. The rhythmical mouth movements were found to have a temperature coefficient of about 3.2. The food in the intestine is in the form of oval masses surrounded by a capsule; during digestion the food capsules become at first relatively acid, then more alkaline.

In starfishes (*Asterias*, *Porania*) the pyloric caeca become acid to congo-red during digestion. After *Pecten* is fed on Diatoms the skeletons are found in the style, which is probably formed by the mixing of the food with the secretion of the digestive gland. Various observations were made on the formation of enzymes and on the conditions in which they act.

Theory of Abyssal Light.*—C. C. Nutting brings forward a number of facts which seem to him to indicate that a "bathysal" light, produced by phosphorescence, may be sufficient to be of use to deep-sea animals. The eyes of "bathysal" animals are larger, on the average, than those of their relatives in shallow water. These enlarged eyes are regarded as an indication that the abyssal light is sufficient to be of utility to their possessors. The coloration of deep-sea fishes is largely protective and aggressive. The coloration of the lower Invertebrates is thought to be adaptive, as in the case of shallow water animals. The coloration of commensals may be protective. It is held to be possible that the phosphorescence of the lower eyeless forms, such as Cœlentera, may be of the same utility as alluring coloration among the higher animals.

Intensive Study of Plankton around South End of Isle of Man.† W. A. Herdman, A. Scott, and W. J. Dakin have co-operated in an interesting study, some of the general conclusions of which may be stated. There is a great increase in spring, due mainly to the sudden appearance of enormous quantities of Diatoms. There is usually a second less marked and less constant increase in September to October. It is largely composed of Copepods, but some Diatoms, and on occasions Dinoflagellates in quantity may also be present. The Dinoflagellates have usually one well-marked peak or maximum in the year, and that lies somewhere between the extremes of April and August. On the whole, the Copepods have their greatest abundance in early summer (May and June), and again in autumn (September). There is usually a marked drop about midsummer. As a rule the Dinoflagellate maximum in early summer is later than that of the Diatoms, but precedes that of the Copepods. Some organisms, such as nauplii of *Balanus*, show a remarkable regularity in their time of appearance. The most populous zone in the sea is below the surface, but above 10 fathoms. The memoir includes some interesting photographs of "monotonic" plankton.

Vestiges of Thyroid in Chlamydoselachus and Dogfish.‡—T. Goodey found in *Chlamydoselachus anguineus* that a narrow tube, intimately connected with the thyroid gland, extends from the thyroid (a compact mass on the ventral surface of the basihyal cartilage) to the

* Proc. 7th Internat. Zool. Congress, 1907 (advance print published 1910) p. 11.

† Lancashire Sea Fisheries Lab., 18th Rep. (1910) pp. 193-297 (21 figs.).

‡ Anat. Anzeig., xxxvi. (1910) pp. 104-8 (4 figs.).

mouth. It is to be regarded as a remnant of a thyroid duct. In the basi-hyal of *Seyllium canicula* and *S. catulus* there is a small foramen, and gland follicles like those of thyroid may occur in it. Perhaps the foramen marks the situation of the anterior end of the original evagination of the thyroid from the ventral wall of the oral cavity. The author recalls the fact that the thyro-glossal duct occasionally persists as an abnormality in man.

Rearing Marine Larvæ.*—E. J. Allen and E. W. Nelson have made numerous experiments on the culture of plankton organisms (especially Diatoms) and on the rearing of marine larvæ (sea-urchins, Polychæts, molluscs, etc.). We give their summary of the precautions to be taken in rearing larvæ.

The eggs of the female selected must be really ripe, and the spermatozoa of the male active. The smallest quantity of sperm necessary to fertilize the eggs should be used. Sterile sea-water, treated in such a way that Diatoms, etc., will grow well in it, should be used. No frequent change of water is then necessary.

All dishes, jars, instruments and pipettes should be carefully sterilized before use. Every possible effort should be made to prevent the introduction into the rearing-jars of any organisms other than the larvæ to be reared and organisms on which they feed. The jars should be covered with loosely-fitting glass covers. The eggs after fertilization must be separated from all foreign matter, pieces of ovary, or testis, etc. As soon as the larvæ swim up they should be pipetted off into fresh vessels of treated water, so as to leave behind any unsegmented eggs, etc.

The food organisms should be small in size, so that the larvæ can draw them into the mouth by ciliary currents. The food should distribute itself through the body of the liquid, and not settle too readily on the bottom of the vessel. (This is one of the great advantages of the Diatom *Nitzschia closterium*, *forma minutissima*.)

The food should be abundant early, so that the larvæ may commence feeding as soon as they are able to do so. The food, however, must not be allowed to get excessively thick in the water. It can be kept down by diminishing the light or by changing some of the water. The temperature should be kept as constant as possible. Within limits, the actual degree of temperature is not so important as the avoidance of rapid change of temperature. A good north light, not exposed to direct sunlight, is most suitable for the rearing-jars.

In determining the amount of water to be used in any particular vessel, regard must be had to the amount of water surface exposed to the air, which should be large in proportion to the volume of the water. A change of food is generally required after the metamorphosis of the larvæ.

Zoology of the Minotaur Myth.†—C. Keller gives a learned discussion of the extinct fauna of Crete, in the course of which he argues ingeniously that Minotaur is a synonym for *Bos primigenius*.

* Journ. Biol. Assoc., viii. (1910) pp. 421-74.

† Viert. Nat. Ges. Zurich, liv. (1909) pp. 424-35.

Mouth and Pharynx of Hamster.*—P. Roscher describes the whole anterior region of the alimentary system in *Cricetus frumentarius*—the cheek-pouches, tongue, teeth, glands, etc. The cheek-pouches are for transport to the place of storage; they have nothing to do with digestion. They might be compared to a paunch. The buccal glands are highly developed. Minute descriptions are given of all the parts.

Kidneys of Fishes.†—Frédéric Guitel describes the kidneys of *Aphya pellucida*, *A. ferreri*, *Tripterygion nasus*, and *Clinus argentatus*. In at least three of these (*Aphya ferreri* is doubtful) the kidney is a persistent pronephros.

Venous System of the Lamprey.‡—B. Možejko gives a preliminary account of part of this system. He deals with the abdominal venous sinus, the hepatic veins, the anterior cardinal or jugular veins, the ventral jugular vein, the peribranchial cavities, the median sinuses, the sinuses at the anterior end of the head, the orbital sinuses, and the facial veins.

Tunicata.

Development of Salpa Chain.§—Myrtle Elizabeth Johnson describes the manner and rate of growth of the zooids of the chain of *Salpa fusiformis-runcinata*. Some account is also given of chains of *S. zonaria-cordiformis* and *S. cylindrica*. Some of the chief observations are summarized as follows:—

The chain of *Salpa fusiformis-runcinata* is made up of a series of blocks, the zooids of each block being approximately the same size. Between the last two blocks is found a short piece, the intermediate piece, containing imperfect or undeveloped zooids, while in the proximal portion of the chain is a deploying point where the zooids change from single to double file. A terminal remnant of imperfect zooids is found at the distal end of the chain, unless the distal block is the first one produced. The unsegmented chain consists of a tubular sheath of ectoderm enclosing strands containing the various embryonic elements. The chain elongates and becomes cut up into a series of segments, each containing its share of the embryonic elements. This segmentation is initiated and carried on by the infolding of the ectoderm. As the zooids grow, they push each other out of line so that they change from a single file to double file. The regular segmentation of the proximal portion of the chain is sometimes interrupted by an unsegmented space. The blood tubes, which run through the chain, grow smaller and disappear before the zooids are set free. This disappearance begins at the distal end. As the vascular connexion disappears, papillæ develop, which unite adjacent zooids and may or may not furnish nutritional connexion. The zooids at the ends of the block are much smaller than the intermediate zooids. The maximum size (length or width) is near the distal end in the younger blocks. In one block of large zooids the maximum size is near, though not at the proximal end of the block. In

* SB. k. Akad. Wiss. Wien, Math-Nat. Classe, cxviii. (1909) pp. 441-504 (2 pls.).

† Arch. Zool. Expér., v. (1910) Notes et Revue, pp. i-x. (1 fig.).

‡ Anat. Anzeig., xxxvi. (1910) pp. 618-43 (4 figs.).

§ Univ. California Publications (Zool.) viii. (1910) pp. 145-76.

the oldest block, the most proximal zooids are larger than the most distal ones; in the youngest, the distal ones are larger than the proximal. *S. zonaria-cordiformis* has "no intermediate piece" or "terminal remnant," and the segmentation at the base is not interrupted by an unsegmented portion. The zooids of the blocks are smallest at each end, the maximum occurring near, but not at the distal end. *S. cylindrica* has an intermediate piece. The zooids are smaller at each end of the block, and the maximum size occurs near, but not at the distal end. These results suggest that further investigation may show the graph of the block to be a reliable species character. The stalk of *Equisetum robustum* has shorter internodes at the base and at the tip, the maximum ones occurring near the base. The diameter of the internodes is least at each end and greatest in the middle. An unusually small zooid is often found opposite an unusually large one in the salpa chain.

The conclusions reached of a more general or theoretical character are: The periodicity occurring in the salpa chain may be a phenomenon comparable with the grand period of growth, and also with the length period of the internodes, as defined by botanists. R. Pearl's first law of growth finds a parallel for the salpa chain, since the size of a zooid is a function of its position in the block.

INVERTEBRATA.

Mollusca.

a. Cephalopoda.

Follicular Epithelium of Cephalopods.* — C. Saint-Hilaire gives an account of the minute structure of follicular epithelium in *Eledone*, *Loligo*, and *Sepiolo*, which is remarkable for the complex system of intra-cellular ducts, previously referred to as vacuoles.

γ. Gastropoda.

Luminosity of *Phyllirhoe bucephala*. † — E. Trojan has made a study of *Phyllirhoe bucephala* Peron and Lesneur, with special reference to its luminosity. As far as is known, this is the only Pteropod which is luminous in itself. Two kinds of glandular cells occur in the skin of *P. bucephala*—mucous cells and albumin gland-cells. The former tend to form many-celled glands, the latter always remain isolated. The animal has chromatophores with numerous pigment-granules. These function in the same way as those of Cephalopods. There are peculiarly large mucous glands on the lips of *P. bucephala*, and it may be that these replace the salivary glands of other forms. This mollusc possesses both single-celled and many-celled skin sense-organs, the latter showing some resemblance to the sensory buds of lower Vertebrates. Luminosity is only observable after stimulation. It is of two kinds: a weak light diffused over the whole body and including the tentacles, and a more intense light restricted to definite points, which are absent altogether from the tentacles and the tail, and most frequent in the latter third of

* Zeitschr. wiss. Zool., xcv. (1910) pp. 316-26 (1 pl.).

† Arch. Mikr. Anat., lxxv. (1910) pp. 473-518 (2 pls. and 4 figs.).

the body. The first kind arises from the mucous cells, the secretion of these single-celled glands being luminous. The points of intenser light on the sides of the animal come from luminous organs formed by the aggregation of single-celled glands. Each of these, even when associated with others, retains its bottle-shape and its long separate duct. The number of cells that go to make up a luminous organ may be as many as twenty. The development of the organs can be traced step by step in the same animal. Whether the secretion of the mucous cells is luminous, alone or with the co-operation of that of the albumin cells, was not demonstrated. But the luminosity of *Phyllirhoe* is undoubtedly extra-cellular and extra-glandular. The animal is probably poisonous, and the biological significance of the light may be analogous to that of warning colours.

Gastropod Foot and Branchial Cavity.*—Hilda M. Bishop has studied the structural features of the foot of various Gastropods in correlation with the observed functional activities, e.g. in *Haliotis*, *Patella*, *Trochus*, *Paludina*, *Littorina*, and *Cypræa*. The creeping mechanism, the adhesion at rest, and the retraction into the shell, are particularly discussed. There are also notes on the ctenidia and on the mucus-glands in the branchial cavity of *Littorina*.

New Genus of Nudibranchs.†—A. Vayssièrè describes *Eliotia souleyeti* g. et sp. n., a new type from the Mediterranean, which he names after Charles Eliot and Souleyet. It is a minute form with its nearest relatives in *Madrella*. A new family, Madrellidæ, is proposed for the two genera, and this is left in the meantime among the Æolididæ adjacent to the Coryphellidæ.

Tentacular Anomaly in Chromodoris elegans.‡—A. Vayssièrè describes a specimen in which the left rhinophore or dorsal tentacle was bifurcate at the base. The associated nerve showed a simple bifurcation as it entered the stalk.

5. Lamellibranchiata.

History of Mya arenaria.§—Henry H. Howorth argues that *Mya arenaria*, one of the very commonest shells in the present seas of Scandinavia, Britain, and Belgium, has only recently invaded this area. It is not an Arctic shell, but a boreal one. It has not been found living in Arctic waters, and the statement that it occurs there has been due to a mistaken inference. Hence, all deductions as to glacial climate deduced from its having occurred in certain beds must fall to the ground.

Marine Lamellibranchs of Siam.||—H. Lyngø reports on a large collection from the Gulf of Siam, which raises the number of known species from that region from 85 to 379, and includes many new forms. There do not seem to be any peculiar forms, and the whole character of the collection is Indo-Pacific.

* Ann. Nat. Hist., v. (1910) pp. 513-24.

† Ann. Sci. Nat., x. (1909) pp. 97-108 (2 pls.).

‡ Tom. cit., pp. 103-10 (2 figs.).

§ Proc. Zool. Soc. London, 1909, pt. 4 (published 1910) pp. 745-67 (8 figs.).

|| Mem. Acad. Sci. Danemark, v. (1909) No. 3, pp. 100-299 (5 pls. and 1 map).

Arthropoda.**a. Insecta.**

Bionomics of the House-fly.*—C. G. Hewitt publishes the third part of his fine study of the structure, development, and bionomics of the house-fly, *Musca domestica*. This paper deals with the habits of the house-fly, its allies, its enemies (parasitic and other), and finally its relation to human disease. The distribution of *M. domestica* is almost world-wide, for it has apparently followed man everywhere. In this country it is by far the commonest species, and may be almost the only one in warm kitchens, etc., where food is present, but in other rooms the lesser house-fly, *Hamalomyia canicularis*, is often abundant, and sometimes predominates. In country houses *Stomoxys calcitrans*, which is not a house-fly in the strict sense, is often the dominant species. The author gives some account of the life-history and the breeding-places of other species occurring as co-inhabitants of houses, and then proceeds to discuss the physiology of *Musca domestica*.

Reference is made to previous papers in regard to the influence of food, temperature, and light, and the bearing of these on the question of hibernation is indicated. While the great majority of the flies observed in summer are killed off or die naturally on the approach of winter, some, apparently the most recently emerged, hibernate throughout the cold weather. Dissection showed that the abdomens of hibernating individuals are packed with fat cells, the fat body having developed enormously, and that the alimentary canal shrinks into a very small space. Dark places are sought out and many flies hibernate between the wall-paper and the walls of living rooms. Hibernation is more or less complete according to temperature, and the same factor determines the time of emergence in spring. Flies, though capable of fairly long flights, do not normally fly far from their breeding-places, but they may be borne by the wind for considerable distances. Experiments in regard to regeneration showed that broken wings and legs are not re-grown, although the wing has been known to be regenerated in the case of a newly pupated fly.

By far the most important of the natural enemies of the house-fly is the fungus *Empusa muscæ* Cohn, which kills off great numbers in autumn. It may be recognized as a whitish ring of fungal spores surrounding the dead body of a fly attached to a wall or window-pane. The life-history of the fungus is described, and it is suggested that it might be artificially cultivated and disseminated so as to rid us of the flies at the beginning instead of at the end of summer. An Arachnid, *Chernes nodosus*, and certain mites are frequently found firmly attached to the bodies of flies, but there is not sufficient experimental evidence to show whether these are really parasitic, or whether they merely use their hosts as a medium of transportation. The investigator found within the head region of two of the flies dissected the Nematode worm *Habronema muscæ*, seen by Carter in Bombay, but not previously recorded for this country.

The last part of the paper contains a discussion of the probabilities

* Quart. Journ. Mic. Sci., lxiv. (1909) pp. 347-414 (1 pl.);

of the dissemination of pathogenic organisms by *Musca domestica* and its non-bloodsucking allies. The evidence, both epidemiological and bacteriological, for the spread of the bacillus of typhoid fever by flies is reviewed, and it is shown that by their agency alone a sporadic incidence in a military camp may be converted into an epidemic. In regard to anthrax, cholera, and tuberculosis, experimental evidence shows that bacilli may be carried on the bodies of flies, and afterwards transferred to food-stuffs, and to wounded or moist surfaces. Conjunctivitis, especially Egyptian ophthalmia, is most probably spread in a similar manner, but bacteriological evidence on this point is lacking.

Development of the Dragon-fly. —P. Backhoff has studied the development of the copulatory apparatus in the Zygopteron genus *Agrion*, most of which takes place in the post-embryonic period. The larval period of the Agrionidae falls into nine stages with seven moults, not counting the actual emergence. The development of the copulatory apparatus extends over the last three larval stages, and continues till the perfect insect has attained its full development. It shows increasing intensity and rapidity, so that the main development takes place just before the emergence of the imago. There is no special penis musculature, erection being brought about by the abdominal muscles. The copulatory apparatus is a hypodermic outgrowth, and as such is quite independent of the embryonic limb-rudiments. It consists wholly of epithelial tissue. Its development is accompanied by a partial moult. The penis of Zygoptera is not connected with the sperm-capsule, but communicates with the blood-lacunæ of the body sinuses and ends blindly on the external aspect. The copulatory organs are more primitive in the Zygoptera than in the Anisoptera. The copulatory organs of the Odonata must have evolved in the Permian or Triassic period.

Study of the Honey-bee.†—E. Zander publishes the first two of a series of studies on the honey-bee, *Apis mellifica*. The first paper contains a full description of the development and comparative anatomy of the thoracic exoskeleton of the bee and the wasp, with special reference to the disputed point of the exact composition of the thorax. Both the development and the anatomy show that the division of the thorax from the abdomen lies between the fourth and the fifth segment, the fourth being displaced forwards to form the posterior wall of the thorax, the fifth forming the stalk and the anterior wall of the abdomen. The cleft between the two the author regards as an extremely developed intersegmental furrow.

In the second paper the structure and mechanism of the flight-apparatus of the honey-bee are discussed. The author describes the complicated flight-movements, vertical and rotatory, but rejects the conclusion of Marey and others that all except the vertical movements are due to the resistance of the air. He regards the synchronism of the movements as due to the unity of the impulse, that is, of the muscular effort. A detailed morpho-physiological analysis showed that all the parts of the flight-apparatus are so marvellously fitted together that a single muscle-

* Zeitschr. wiss. Zool., xcv. (1910) pp. 647-706 (1 pl. and 29 figs.).

† Tom. cit., pp. 507-17 (1 pl. and 8 figs.); pp. 517-50 (2 pls. and 6 figs.).

contraction, either in a vertical or a longitudinal direction, is sufficient to give rise to the whole of the complicated movements, since the contraction arises from a single point in the wing-root. Observation has shown that the mechanism of flight varies greatly within the class Insecta, so that the above conclusion cannot be applied to other forms without investigation.

Gametogenesis of Gall-fly.*—L. Doncaster gives the following summary of his chief results. The gall-fly, *Neuroterus lenticularis*, has two generations in the year, the flies appearing in April and June respectively. The spring generation consists exclusively of females, which differ considerably from the females of the summer brood. Their parthenogenetic eggs are laid in oak buds, and all the eggs laid by any one female develop into individuals of the same sex in June, i.e. some of the spring females are male-producing, others are female-producing. The summer generation thus consists of males and females; their eggs are fertilized, and are laid in the tissue of young oak leaves, and give rise to galls very different from those produced in the spring. The flies from these galls hatch in April, and thus complete the cycle.

Mitoses in the body-tissues of young pupæ show about twenty chromosomes, both in the spring parthenogenetic females, and the males and females of the summer brood. In the spermatogonia of young male larvæ, mitoses show ten chromosomes. In the primary spermatocytes of young pupæ ten chromosomes appear. An imperfect mitotic figure is developed, but the nuclear membrane does not disappear, and after the metaphase is reached the nucleus returns to a "resting" condition. During this process the cell develops an elongation at one end, at the tip of which is one of the centrosomes (or centrioles); as the nucleus re-forms, the centrosome and a small piece of cytoplasm are separated off, as happens in the bee and wasp. The process is thus much like that found in the bee, except that the nucleus returns to a "resting" condition.

The spermatocytes now develop about twenty chromatin masses which form themselves into ten band-like chromosomes. These shorten, form an equatorial plate across the cell, a typical spindle is produced; and the chromosomes divide so that ten travel into each daughter-nucleus. Two spermatids are produced, which are similar, except that in some cases at least one of them receives a small extra-nuclear body of unknown nature which is absent from the other. Both spermatids develop into spermatozoa. In primitive ova in the young female larvæ of the summer generation mitoses like those in the body-cells are found, with apparently twenty chromosomes. After the deposition of yolk has begun, no further nuclear divisions occur in the egg.

The maturation divisions of the summer eggs are difficult to follow, but apparently two divisions occur, giving rise to four groups of chromosomes, of which the three outer represent the three polar nuclei, while the innermost group sinks in to form the female pronucleus. This group probably consists of ten chromosomes, but they are so crowded that the number commonly appears rather less in sections.

The male pronucleus and the female pronucleus meet and form the

* Proc. Roy. Soc., Series B, lxxxii. (1910) pp. 88-113 (3 pls.).

first segmentation spindle, in which, as in the later segmentation divisions, about twenty chromosomes appear. The polar chromosomes disintegrate and disappear. The primitive ova of the spring generation have not been observed. In an egg from the egg-tube of a young pupa twenty chromosomes were seen in the nucleus.

The maturation of the spring egg has not yet been sufficiently studied, but it appears that some eggs undergo at least one maturation division, others probably none. In eggs in which maturation has occurred, segmentation mitoses show ten chromosomes; all the eggs laid by one individual female in which the chromosomes could be counted were of this type, and it is suggested that these develop into males. In the eggs laid by other females, however, twenty chromosomes appear to be absent, and it is probable that there has been no maturation division, and that these eggs would develop into females.

New Host of *Lynchia maura*.*—E. Massonnet discusses the distribution of Hippoboscidae and of *Lynchia maura* Bigot in particular. Their range usually depends on their power of flight, and that on the proportion of length of wing to length of body. The genus *Ornithomyia* stands first and has most hosts, while *Cratærhina pallida* Olf. with rudimentary wings, is restricted to martin and swallow, and the wingless *Melophagus ovinus* to the sheep only. In *Lynchia maura*, however, which has wings as well developed as those of *Ornithomyia avicularia*, only one host has hitherto been known—namely, pigeons of the Mediterranean region. The author now records it from *Strix bubo*, and gives reasons for not regarding this as accidental.

Caterpillars of *Epichnopteryx helicinella*.†—C. Vaney and A. Conte have studied this well-known Psychid. The larva lives in a case coiled in a loose spiral, and the larva is itself coiled. The coiling is essentially dorso-ventral, very slightly lateral. In September all the cases enclose remains of the mother-insects and numerous larvæ which hibernate in the shelter of these. As many as thirty-five larvæ were found in one tube, each showing the characteristic torsion. In fact, the torsion is the primitive embryonic torsion seen in all Lepidoptera.

Why is it retained throughout the larval period? This is due to the pressure exerted on all the larval tissues during the long period of hibernation by the inert and compact substances (vitellus and silk) accumulated in the body. The torsion is not in any way comparable to the torsion of a hermit-crab, which is secondary.

Mosquito Fed by Ant.‡—E. Jacobson found a small mosquito in Java which is regularly fed by the ant *Crematogaster difformis*. The mosquito frequents trees where the ants pass to and fro. It stops one and strokes the head quickly with fore-limbs and antennæ. The ant emits a drop of juice, which the mosquito quickly licks up. Then the ant goes on its way. J. C. H. de Meijere has described the mosquito as *Harpagomyia splendens*, and points out that there are no piercing organs connected with the proboscis, nor any trace of mandibles and first

* C.R. Soc. Biol. Paris, lxxviii. (1910) pp. 430-2.

† Tom. cit., pp. 432-4.

‡ Tijdschr. Entomol., lii. (1909) pp. 158-74 (1 pl.). See also Zool. Zentralbl., xvii. (1910) pp. 250-1.

maxillæ. Jacobson also found another Dipteron, named by de Meijere *Proscætomicilia myrmecophila* g. et sp.n., behaving in a similar way to the same ant, while yet another, *P. brevisrostris*, tapped another ant, *Dolichoderus bituberculatus* Mayr. Both of these species touched the tip of the abdomen with their proboscis.

Piophilæ Larvæ in Cheese.*—G. Alessandrini has made experiments on dogs by giving them abundance of the *Piophilæ*-larvæ, which some people like in their cheese. The larvæ can pass through the gut of man and dog without being affected. They are extraordinarily tough, able to survive sixteen hours in 70 p.c. alcohol, thirty hours in petroleum. They do some damage to the wall of the intestine by working their oral hooks and the papillæ on their ventral surface.

Structure and Habits of Claviger testaceus.†—E. Krüger gives an interesting account of this beetle, which lives with ants, and is patted and licked by them for the sake of an exudation. The glands which secrete this are described. There are two different sets of them. There are also odoriferous glands, which Wasmann discovered. The modifications of the mouth-parts are discussed, such as the simplification of the mandibles. The reproductive system is also described.

Rat-fleas.‡—J. Const. Gauthier and A. Raybaud have proved by direct observation that the rat-fleas, *Ceratophyllus fasciatus* and *Ctenopsylla musculi* can bite man and can thrive on human blood. They also show that the bacillus of Yersin may survive for a long time in hibernating fleas (*C. fasciatus*) at a low temperature.

Roumanian Blood-sucking Diptera.§—N. Leon reports the unwelcome presence in Roumania of *Phlebotomus papatasi*, one of the Psychodidæ, whose bite causes a fever in dogs.

Structure of Trigonalys hahni.||—E. Bugnion has made a study of this rare parasite of wasps, describing the structure of the abdomen, the alimentary canal, the mouth-parts, and the genital organs. He directs attention to the "tyloides"—peculiar sensory structures borne on the antennæ of the male. They have been described in Ichneumonids by R. du Buysson, and are probably olfactory.

Study of an Ephemeroïd.¶—H. Drenkelfort has made a detailed study of the habits, life-history, and structure of a May-fly, *Siphilurus lacustris* Eaton.

Development of Plasmatidæ.**—Johann Hammerschmidt has studied this in *Dixippus morosus* Br. with special reference to the origin of the mid-gut epithelium. It begins in yolk-cells, which form a primary endoderm, and lie like an epithelium marking the outer

* Arch. Parasitol., xiii. (1909) pp. 337-82 (33 figs.). See also Zool. Zentralbl., xvii. (1910) pp. 247-8.

† Zeitschr. wiss. Zool., xcv. (1910) pp. 327-81 (2 pls. and 33 figs.).

‡ C.R. Soc. Biol. Paris, lxxviii. (1910) pp. 941-4.

§ Centralbl. Bakt. Parasitenk., liv. (1910) pp. 521-3 (1 fig.).

|| MT. Schweiz. Entomolog. Ges., xii. (1910) pp. 14-20 (4 pls.).

¶ Zool. Jahrb., xxix. (1910) pp. 527-617 (3 pls.).

** Zeitschr. wiss. Zool., xcv. (1910) pp. 221-42 (2 pls.).

boundary of the yolk. As development goes on, this is replaced by a secondary endoderm of mesodermic origin. Anteriorly this arises from lateral sub-oesophageal bodies; in the rest of the body from mesodermic aggregation in the middle line (the "chorda" of Nusbaum, the "blood-cell-strand" of Heymons).

Glands of Caterpillars.*—L. Bordas has investigated a large series of caterpillars in respect to their glands. He describes a series of silk-glands of various types, and the accessory glands of Lyonnet. The minute structure is also discussed, and the production of silk. Bordas confirms what Gilson noted, that the raw material of the silk is elaborated both in nucleus and cytoplasm. It passes into the internal cavity of the gland, going through the cuticular intima by a process more like filtration than osmosis. In the lumen of the gland it undergoes various changes. The thread of silk has a hyaline homogeneous core, the silk proper, and a delicate cortical sheath, which is removed by washing. The accessory glands secrete a liquid, or slightly viscous material, which serves to unite the threads of silk, and possibly acts on them chemically, so that they are rapidly hardened. Bordas has found thoracic glands on most of the caterpillars he has studied. They sometimes secrete an offensive fluid, as in the caterpillar of the puss moth. In almost all cases there are mandibular glands, whose secretion is partly digestive, but especially defensive.

Thysanura and Collembola of Midland Plateau.†—Walter E. Collinge enumerates two species of Thysanura and thirty-eight species and three varieties of Collembola. One of the varieties of Collembola is new, *Lepidocyrtus lanuginosus* var. *plumbeus*.

Thorax of Insects and Articulation of Wings.‡—R. E. Snodgrass seeks to show the unity of structure that prevails throughout all the orders of Insects. He accepts six primitive head-segments, provided that the apparent superlingual is a real segment, and one microthoracic, or neck-segment. The sclerites of the microthorax form the cervical sclerites of the neck, often reduced or rudimentary, and the gular-plate of the head, when such a plate is present. Its appendages form the labium.

The thorax proper has three segments. (In Hymenoptera the tergum of the first abdominal segment is added.) These three segments are primary metameres. The sclerites in each are subdivisions of the wall of one primitive segment, and the apparent double nature of each segment is secondary. Characters that have been urged as special evidence to the contrary, such as the equivalence of the episternum and epimerum and the double structure of the coxa in some orders, lose their significance when nymphal, larval, and pupal forms are examined. The wing is hinged to the notum on the two notal wing processes, and is supported from below upon the wing process of the pleurum.

* Ann. Sci. Nat., x. (1909) pp. 125-98 (3 pls. and 22 figs.).

† Birmingham Nat. Hist. Phil. Soc., 1910, 14 pp. (6 figs.)

‡ Proc. U.S. Nat. Museum, xxxvi. (1909) pp. 511-95 (30 pls.).

5. Arachnida.

Courtship of Spiders.*—T. H. Montgomery discusses the significance of the courtship and the secondary sexual characters of Araneids. After describing the general mating relations, the numerical proportions of the sexes, the relative time of maturity, and the senses employed in sexual recognition and stimulation, the author gives an account of the phenomena of courtship in "Snarers" and "Hunters," taken partly from his own observations on the Lycosids, partly from the literature of the subject.

He finds that, in the male, the chief psychical condition is sexual desire resulting from a physiological state due to internal secretions at the time of maturity. But with this is associated an inhibiting factor, the male's fear of the female. One of the most general motions made by the male is the raising of the forelegs towards the female, and this is but a modification of the spider's general attitude of defence—a motion exhibited by both sexes when strongly disturbed. Similar explanations are suggested in regard to the waving of the palpi, which may follow any excitement, and the lateral flexion of the abdomen, which may be due to the tension of a silken thread secreted when the spider, in his movements, touches the ground with his spinnerets.

Montgomery concludes that the male spider, in visual courtship, is not actuated by a conscious effort to exhibit his peculiar beauties, and that the female does not select males by an æsthetic sense. Courtship by the male results simply because fear is mingled with his desire; and probably the female will accept the first male who courts her and makes himself recognized as a male at the time when she is physiologically desirous. Sexual selection, in Darwin's sense, has probably played no part in the evolution of the secondary sexual characters of spiders. The nature and use of secondary sexual characters are next discussed. They are classified as: weapons employed by males in their combats with one another; characters used for sexual recognition and sexual stimulation; characters of more immediate value in assuring approximation of the sexes and copulation; characters of value in provision for and nurture of the progeny; characters due to habitudinal differences of the sexes; characters of value in protecting a particular sex against other species. Analysis of these six categories of secondary sexual characters shows that, as far as spiders are concerned, natural selection alone is sufficient to explain the regulation of the phenomena. At the same time, these phenomena would seem to have a manifold origin, as they certainly fulfil very different uses.

New Hydrachnids.†—Edward Schechtel describes *Limnesia polonica* sp. n., and the hitherto unknown female of *Arrenurus nodosus* Koen., both from Galicia.

6. Crustacea.

Sympathetic Nervous System of Crustacea.‡—Jerzy Stanislaw Alexandrowicz has studied this in rock lobster (*Palinurus*), crayfish

* Amer. Nat., xliv. (1910) pp. 151-77.

† Bull. Internat. Acad. Sci. Cracovie, 1910, pp. 92-4 (1 pl.).

‡ Jenaisch. Zeitschr. Naturw., xlv. (1909) pp. 395-444 (5 pls. and 8 figs.)

(*Astacus*), and some other forms. There is an autonomic system connected with the central system. Its function is to set the peristalsis going and to control it. It consists of bipolar cells, each of which gives off, on the one hand, a "receptor" process to the lumen of the gut, and, on the other hand, an "effector" process which unites with that of other cells in a plexus, from which fibres go to the muscles, stimulating a terminal plexus. The nerve from the last abdominal ganglion has very numerous ramifications in the musculature, where it unites with the motor fibres. It regulates the automatic movement.

Amphipods from North Side of Bay of Biscay.*—E. W. Sexton discusses a number of Pleustidæ and Eusiridæ. In some species several stages of development were found, which seem to prove conclusively that not only do these animals become sexually mature before attaining their full growth, but that, in both sexes, the secondary sexual characters undergo considerable modification after sexual maturity is reached, the character most affected being the second gnathopod.

Sexual dimorphism is well illustrated in the collection, the second gnathopod being the organ generally affected. One species, *Sympleustes grandimanus* Chevreux displays a very unusual and marked type of dimorphism, the side-plates and peræopods differing widely in the two sexes, as well as both the gnathopods.

The mouth-parts remain very constant, and form the safest basis for specific distinctions. The antennæ and gnathopods, usually relied on, are the parts most affected by sex and development. But it is in the sensory equipment that most change is seen after sexual maturity is reached: the ommatidia increase in number, the flagella of the antennæ increase in length, those of the male to a far greater degree than those of the female, the calceoli, sensory filaments, and the like, develop in both sexes, and the peduncles of the antennæ in the male become covered with masses or thick tufts of sensory filaments or sensory setæ.

Coagulation of Blood in Arthrostraca.†—John Tait has studied this in *Ligia oceanica*. The explosive cells, discovered by Hardy in the crayfish, have been studied in films of Isopod blood. They discharge into the immediately surrounding plasma a material which either itself coagulates or there induces coagulation in the portions of plasma reached by it. In this way a little localized island of coagulation is formed around each exploded corpuscle. These islands, once formed, are fixed structures, with a definite boundary, which has no tendency to become diffuse or to spread outwards. There is thus a limit to the range of action of the explosive corpuscles, and there is no evidence that, as Hardy suggested, they yield a ferment which causes the plasma, as a whole, to coagulate.

On first formation, these localized coagula are plastic structures, which can be modified in shape by movements of the surrounding fluid. They are likewise sticky, and tend to adhere to or entangle any cells with which they come in contact. They soon set and harden, however. In a film that has been kept at rest their usual form is circular. The

* Proc. Zool. Soc., 1909, pt. iv. (published 1910) pp. 848-79 (2 pls. and 2 figs.).

† Quart. Journ. Exper. Physiol., iii. (1910) pp. 1-20.

actual formation of these coagula in situ at a wound may be watched in the Amphipod *Gammarus*, and the part which they play in the natural arrest of hæmorrhage thus studied. They help to stop the bleeding by forming an adherent bunch of globules or botryoidal mass at the site of injury. To these globules issuing blood-cells tend to adhere, thus further clogging up the paths by which the blood escapes. The birth of one of these globules is accompanied by a considerable output of kinetic energy, the explosion consisting not merely in a shedding out of material from the corpuscle, but in an actual rending and breaking apart of the immediately surrounding clot. This process suggests an analogy with MacDonal's hypothesis regarding the cause of muscle contraction. The part played by these localized coagula must not be taken in the meantime to supersede or dispose of the cell-agglutination hypothesis put forward by other authors as the cause of the first coagulation in Crustacean blood. According to the view here taken, the phenomenon exists alongside of and intimately associated with cell-agglutination as a contributing factor in arrest of hæmorrhage. A second coagulation of Isopod blood, this time involving the whole plasma indiscriminately, may be made out in addition to the aforementioned localized coagulation. There is no histological evidence to associate this second coagulation with the disintegration of any one particular element of the blood more than another.

Antarctic Schizopods and Cumacea.*—H. J. Hansen describes from the collection made by the 'Belgica,' *Euphausia longirostris* sp. n. and *E. superba* Dana. The latter seems to live everywhere in the Antarctic Ocean, and has been taken by every expedition touching any part of these seas. It is the chief food of seals, e.g. *Lobodon carcinophaga*. Hansen describes a number of larval forms, and points out that there is much difference in the development of *Euphausia superba*, *E. pellucida*, and another species of the same genus. In the order Mysidacea he describes *Pseudomma belgicæ* and *Antarctomysis narima*, which occurred also in the 'Discovery' collections. Two new species of Cumacea are described, *Cycluspis glacialis* and *Campylaspis frigida*.

Indian Fresh-water Crabs.†—A. Alcock has made a catalogue of the Potamonidæ in the Indian Museum—43 species and varieties of *Potamon*, 45 of *Paratelphusa*, and 3 of *Gecarcinus*. The Potamonidæ are typical inhabitants of fresh-water, but a few species flourish in brackish water on the one hand and in damp jungle on the other. They are found in ponds, lakes, streams, rivers, and marshes; and though they flourish most at low or inconsiderable levels in the tropics, they extend into the warmer temperate regions, and are also quite common at considerable elevations in the torrid zone. The Indian forms show great variety of habitat, and even one and the same species, e.g. *Paratelphusa spinigera*, may occur from the swamps of Lower Bengal to an elevation of 2000 ft. The variability seems to be considerable.

The eggs are comparatively large and not extremely numerous in a

* Expéd. Antarc. Belg., 1908 (received 1910) pp. 1-20 (3 pls.).

† Catalogue of Indian Decapod Crustacea. I. Brachyura; fasc. ii. Potamonidæ; pp. 1-135 (14 pls.)

batch. They are carried by the mother in the usual way in crabs, and, so far as is known, are hatched not as zœas, but in a much more advanced stage, and the young stay in the mother's brood-pouch until they have attained the adult form and a considerable size. The author discusses the differentiation of species and varieties and the geographical distribution.

Structure of Fresh-water Ostracods.*—Alfred Bergold has investigated the internal structure of various species of *Cypris*, and describes the alimentary canal, the lip-glands, the excretory organs (associated with the first antennæ, the second antennæ, and the maxillæ), the maxillipede gland, and the female genital apparatus.

The mesenteric epithelium shows a typical "stiftchensaum." The cells are both secretory and absorptive. The three segmental organs (of first and second antennæ and maxillæ) are excretory; the labial glands and maxillipede glands are secretory. In the female genital apparatus there are three distinct parts:—the vagina with a copulatory vesicle, a spiral canal with a receptaculum seminis, and a copulatory or cement gland.

Lernæodiscus.†—Max Kollmann points out that in various internal features, notably in the structure of the testis, *Lernæodiscus* approaches *Sacculina* and diverges from *Peltogaster*. The study of the whole structure confirms this view. It seems impossible to derive *Lernæodiscus* from *Peltogaster*, as Smith has proposed. The approximation of *Lernæodiscus* to *Sacculina* and *Heterosaccus* does not present any difficulty. Indeed, *Lernæodiscus* may be compared to a *Heterosaccus* whose mesenteron has been greatly developed to right and left.

Decapod Natantia of Coasts of Ireland.‡—Stanley Kemp reports on 47 species of Decapoda Natantia collected by ss. 'Helga.' Ten species are practically restricted to the littoral and laminarian zones, such as *Hippolyte varians*, *Leander squilla*, and *Orangon vulgaris*; these and some others are also found in brackish water; several species, such as *Pandalus montagui* and *Pandalina brevirostris* may be reckoned as seasonal visitors to the laminarian zone; the great majority live on or very close to the bottom. The following species have, however, been taken under circumstances which afford the clearest proof that they are free-swimming—*Amalopenæus elegans*, *Sergestes robustus*, *S. arcticus*, *Pasiphae sivado*, *Parapasiphae sulcatifrons*, *Acanthephyra purpurea*, *A. debilis*, *Hymenodora glacialis*, *Caridion gordonii*. Of these, *Pasiphae sivado* and *Caridion gordonii* occur constantly on the bottom, but are nevertheless sometimes found in midwater, usually in soundings of no considerable magnitude. The seven remaining forms are, as a general rule, bathypelagic, but *Sergestes robustus* and *Acanthephyra purpurea*, having been found in the stomachs of fish which are known to frequent the ocean floor, must be regarded as members of the benthos as well as of the nekton.

A few species are definitely associated with other animals: *Typton*

* Zool. Jahrb., xxx. (1910) pp. 1-42 (3 pls. and 3 figs.).

† Ann. Sci. Nat. (Zool.) x. (1909) pp. 255-73 (1 pl. and 6 figs.).

‡ Scient. Invest. Fisheries, Ireland, 1908, i. (1910) pp. 1-190 (23 pls.).

spongicola lives within Monaxonid sponges; *Richardina spinicincta*, the only representative of the Stenopidea yet found in British waters, seems restricted to the areas peopled by the Hexactinellid sponge *Pheronema*; *Leontocaris lur* has only been found on two occasions, and in each haul Antipatharians and colonies of *Lophohelia* occurred abundantly. We do not quite follow the author when he says: "This, coupled with the highly specialized structure of the species, suggests the possibility of an *Alcyonarian* association."

Of the 54 species of Decapoda Natantia from British and Irish waters, 19 have been found north of the Arctic circle, while 26 occur in the Mediterranean.

Five species of British and Irish Nantantia (four of which have not been found south of Scotland) are known to live on the bottom in water below freezing-point. These are *Pandalus borealis*, *Spirontocaris polaris*, *S. spinus*, *S. gaimardi*, *Sabinea sarsi*.

Snapping Shrimps.*—Henri Coutière deals with about thirty species and varieties of *Synalpheus* from the American coasts. He divides them into four groups, and discusses their relationships and distribution. A striking fact is the existence of forms almost identical in regions so remote as the Red Sea and California or Florida. For the Synalpheids are very sedentary animals, which are almost never seen to swim, but live in couples in Sponges and Madrepores. Many such facts suggest the idea of species primitively widely dispersed. Coutière finds nothing analogous to the mutations which Bouvier has described among Atyidæ.

Annulata.

Regeneration in Oligochæts.†—F. H. Kreckler deals with phenomena of regeneration in *Limnodrilus*, *Tubifex*, *Lumbriculus*, and *Lumbricus*. *Limnodrilus* does not regenerate a head when more than seven somites have been removed. An interesting point brought out is the small amount of new tissue regenerated at the anterior end. No individual replaced more than one-and-a-half segments, which was the case when the first three somites were removed, and the entire amount removed was regenerated only when the first somite alone had been cut off.

Although lack of movements proper to the head end may prevent the worm (*Limnodrilus*) from burrowing when the anterior segments have been removed posterior to the level at which a head regenerates, still it seems probable that it is also in part due to the important fact that the bluntness of the anterior end in this region prevents the worm from cleaving its way into the mud. For *Limnodrilus* the minimal size of a piece, at different levels within the head-forming region capable of regeneration, is as follows. A head-piece will not regenerate unless it consists of at least 7 somites. At the level of the second somite the minimal piece is also 7 somites, 2-8. At the level of the third somite it is 5 somites, 3-7. At the level of the fourth somite it is 4-7. At the level of the fifth somite it is 3 somites, 5-7. This is the shortest piece of this worm capable of regenerating at both the anterior and the

* Proc. U.S. Nat. Museum, xxxvi. (1909) pp. 1-93 (54 figs.).

† Zeitschr. wiss. Zool., xev. (1910) pp. 383-450 (3 pls.).

posterior ends. At the level of the sixth somite the minimal size is 4 somites. At the level of the seventh somite it is also 4 somites, and at the level of the eighth somite it is 6 somites.

In *Lumbriculus* pieces of the same size from the same level of different individuals do not regenerate the same number of somites at the posterior end in the same length of time (two weeks), nor in a succeeding period of equal length. The same result holds true for *Limnodrilus*.

In *Lumbriculus* the minimal size of a piece from the posterior end of the body capable of regenerating is 35 somites, while ten somites from the posterior end it is 25 somites. In *Limnodrilus* the last four, consecutive pieces 12-15 somites long, do not regenerate.

In *Limnodrilus* and *Tubifex* the presence of the intestine is necessary at the posterior end of the body for regeneration to occur from this point. When a bit of the intestine is removed, so that the intestine does not touch the posterior end of the body-wall, no regeneration takes place from this point. The posterior end of the intestine which ends free in the coelom regenerates until it comes in contact with the posterior end of the body-wall, after which regeneration of the entire body begins at this point. In *Tubifex*, when a portion of the intestine is removed from the anterior end of an individual at a level posterior to the point at which anterior regeneration of the body-wall takes place, the anterior end of the intestine will not regenerate. In *Lumbricus herculeus*, when a portion of the intestine is removed from the anterior end within the region in which a head is formed, so that the intestine does not touch the body-wall, the body-wall will regenerate a tongue of new tissue in which no alimentary tract is present. The presence of an alimentary tract is therefore probably not necessary for the regeneration of the body-wall at the anterior end of *Lumbricus herculeus*.

When the intestine has been removed from the posterior end of *Limnodrilus* and *Tubifex* the wound closes in the same manner as it does under normal circumstances, but thereupon the muscle fibrils of the body-wall musculature stream out into the coelom and, together with peritoneal cells, chloragogen and connective-tissue, form a strand which extends from the posterior end of the body-wall to the posterior end of the intestine. Somewhat similar strands appear to be formed at other points wherever the continuity of the body-wall musculature has been broken. The intestine of *Limnodrilus* and *Tubifex* is regenerated from endoderm alone. When the intestine regenerates independently of the body-wall the intestinal musculature is regenerated from the old intestinal musculature. Under the same conditions the chloragogen is regenerated from the old chloragogen. A proctodaeum was found to form according to the method described by Abel. An abnormal anal opening found in *Tubifex* was probably caused by the entoderm coming in contact with the body-wall. The ectoderm enters the coelom to form mesoderm (*Tubifex* and *Limnodrilus*). The neoblasts perform no phagocytic function. At the posterior end of the body the secondary mesoderm, i.e. the longitudinal muscles of the body-wall, the septa, etc., is regenerated from the neoblasts (*Tubifex* and *Limnodrilus*). The circular muscles of the body-wall are regenerated from the ectoderm cells in situ. When the regeneration of the body-wall does not occur in the absence of the

intestine the neoblasts do not form mesoderm, but collect in an unorganized mass at the posterior end of the body. When, during the absence of the intestine, the regeneration of the body-wall at the posterior end of the body does not take place, the ectoderm cells that have been metamorphosed into neoblast-like cells enter the coelom, and together with the neoblasts form a mass of cells in the ventral half of the coelom. Neither the position of the neoblasts nor the area over which the ectoderm cells are metamorphosed is influenced by inverting the position of the worm's body. The neoblasts are always found about the metamorphosed ectoderm cells at the posterior end of the body, and it seems probable that the neoblasts have some influence in causing the ectoderm cells in their immediate vicinity to assume a neoblast-like character. The neoblasts can migrate towards the anterior end of the body, but they do not come in contact with the ectoderm at this point, and do not form mesoderm. They are not present at the anterior end of *Tubifera* or *Limnodrilus* at levels from which anterior regeneration occurs. They were not found anterior to the tenth somite under any conditions. The secondary mesoderm at the anterior end of the body is formed from the old mesoderm.

Species of Arenicola in Paris Museum.*—J. H. Ashworth reports on the collection of lob-worms in the Museum of Natural History in Paris. It includes *Arenicola marina*, *A. grubii*, *A. ecaudata*, and *A. pusilla*. A description is given of the last.

Body-wall of Leeches.†—L. Hachlov deals in the first instance with *Hirudo medicinalis*, describing the epidermis, the unicellular glands, the connective-tissue, the pigment-cells, the botryoidal tissue, and the musculature. He also discusses "Bayer's sensory organs" in *Clepsine serocolata*.

New Gephyrean Type.‡—F. H. Stewart describes from the Indian Ocean *Investigator sicarius* g. et sp.n., which seems to be a type of a new order of Gephyrea. The order Investigatoroidea is thus defined:—Gephyrea with anterior terminal mouth and posterior sub-terminal anus, with a nervous system consisting of dorsal cerebral ganglia and two lateral nerve-cords. Within the phylum, *Investigator* most closely approaches Priapulioidea, the only important difference being in the nervous system.

The body is divided into a sausage-shaped trunk, a longer narrower neck, and a globular introvertible head. There are numerous glassy chitinous spines. The hind end of the body is formed by a flatly conical shield. The spines at the edge of the shield are long and spike-like, projecting outwards, but on the surface of the shield they converge on an aperture in the centre. This leads into a gill-chamber containing a bilaterally divided gill. The anus opens on the ventral wall of this chamber. There are two nephridia opening at the edge of the shield.

Life-history of Diplodiscus temporatus.§—L. R. Cary has made an experimental study of the life-history of *Diplodiscus temporatus* Staf-

* Ann. Sci. Nat., x. (1909) pp. 111-24 (4 figs.).

† Zool. Jahrb., xxix. (1910) pp. 449-84 (3 pls. and 3 figs.).

‡ Memoirs Indian Museum, i. No. 4 (1909) pp. 283-93 (1 pl. and 3 figs.).

§ Zool. Jahrb., xxviii. (1909) pp. 595-659 (4 pls.).

ford, with especial reference to the development of the parthenogenetic eggs. The rediæ and cercariæ in this form show many marked differences from the same stages in the European species, *Amphistomum subclavatum*, with which it has usually been confounded. For the formation of a complete cyst it is essential that the cercaria be able to attach itself to some substratum by means of the ventral sucker, otherwise only an open tube of the cyst-forming material will result. The cercariæ are positively heliotropic, and, when set free from the snail in the normal manner, always swim to or near to the surface before encystment takes place. The encysted worms are unable to withstand desiccation for more than one hour. Tadpoles or other animals, which obtain their food by browsing along the banks of streams, may take up the encysted cercariæ with their food. In large tadpoles the worms become transformed into sexually mature worms. In other animals, and in some cases in small tadpoles, the worms become again encysted. If such intermediate hosts are eaten by adult Amphibians, the worms are able to go on developing again. The eggs (germ-cells) in the sporocyst may arise either from cells which have come over from an early developmental stage free in the body-cavity of the sporocyst, or they may, as is the case throughout the later life of the sporocyst, arise from nuclei in the body-wall which become segregated at one end of the body-cavity to form a rudimentary ovary.

The mitosis in this form is intranuclear. All the chromatin in the nucleus is gathered into a single caryosome. (Rarely there are two.) This body is surrounded by a densely staining mass of cytoplasm. The centrosomes in the resting stage of the nucleus lie either in the body of the caryosome, or so closely apposed to it that their identity cannot be made out. The centrosomes become apparent in a comparatively late prophase. In the prophase, the caryosome increases in size at the expense of the nucleoplasm until the whole of the nuclear contents are gathered into a single lightly staining mass, which is connected with the nuclear membrane by several strands. Within this at first homogeneous mass, there appear chromatin granules which later increase in size, and finally fuse to form the spireme thread, which soon segments to form the chromosomes. The spindle fibres are very prominent, each one being apparently made up of several (four) smaller fibres. Up to the metaphase of division, the nuclear membrane retains its nearly spherical shape. The elongation begins in the anaphase, and the constriction follows immediately. In the anaphase the daughter-chromosomes are drawn up into a compact mass in which all outlines of the separate chromosomes are soon lost. The constriction of the nuclear membrane continues until the daughter-nuclei are separated as if by amitosis. The formation of the spireme for the maturation division takes place without the concentration of the whole of the nuclear contents into an enlarged caryosome. Instead, the caryosome becomes directly converted into the spireme thread without the intervention of a stage in which the chromatin exists in small granules. Usually the maturation spindle is excentric in the egg; it is located near that end of the nucleus which lies nearest to the cell-wall. In the formation of the polar body a portion of the nuclear membrane containing one set

of the daughter-chromosomes from the maturation division becomes extruded from the cell, so that the polar body contains no cytoplasm, but consists of a portion of the nucleus surrounded by a double membrane. The mitosis in this form resembles closely that occurring in the Protozoa. The two micromeres which represent the ectoderm, are given off from the single macromere (mesoderm) in the first two divisions. The gastrulation is epibolic. Two of the ectoderm cells in the nine-cell stage are set apart from the rest to form the investing membrane. The embryo soon becomes a syncytium, but separation between the ectoderm and the endoderm usually remains distinct for some time after the cell walls are lost. Sometimes another layer of cells (nuclei and cytoplasm) may be distinguished between the ectoderm and the endoderm.

The primordium of the gut often retains its identity from the stage when it exists as a single cell after the separation of the two primary micromeres. The primordium of the anterior sucking disk, pharynx, and œsophagus becomes marked out at the anterior end of the embryo. The water-vascular system arises as two lateral intracellular tubes, one on either side of the body. The flame-cells arise in connexion with some of the meristem nuclei, and later acquire their connexion with the lateral trunks. The reproductive organs arise first as a single mass of cells, which later become separated into recognizable primordia of the testes, the ovary, and the accessory parts of the reproductive system.

The life-cycle of the *Malacotylea* may be characterized as heterogeny with paedogenesis.

Parasites from Fishes from Irish Sea.* — Jas. Johnstone has notes on *Lebouria idonea* Nicoll, from a dragonet, *Prosthecobothrium dujardinii* (van Beneden) from *Raja maculata* and *Echeueibothrium variabile* van Beneden, *E. dubium* van Beneden, and *Rhinebothrium minimum* (van Beneden) from Rays.

Fasciolopsis.† — Henry B. Ward discusses *Fasciolopsis baskii* Stiles, a Trematode parasitic in the duodenum of man in India, Siam, China, Assam, and Sumatra, and very common in Chinese pigs, and *F. rathhousi* Ward, also from the human intestine in China.

Cysticercoid from a Jerboa-flea.‡ — Alfons Dampf describes a Cysticercoid from the abdominal cavity of *Mesopsylla eucta* sp. n., a flea found on the jerboa, *Alactaga jaculus*, of Turkestan. No tapeworm is known in the jerboa. The hooks of the Cysticercoid are very like those of *Hymenolepis nana*.

Genus Allocreadium.§ — Ivan E. Wallin describes *Allocreadium lobatum* sp. n., a Trematode from the stomach of a fish (*Semotilus bullaris*), and *A. colligatum* sp. n., from the intestine of *Labrus mixtus*. He discusses various other forms, and gives a very useful diagnostic key to the species of *Helicometra*, *Allocreadium*, and *Lepocreadium*, within the sub-family Allocreadiinæ.

* Lancashire Sea Fisheries Lab., 18th Rep., pp. 16-37 (11 figs.).

† Trans. Amer. Micr. Soc., xxix. (1909) pp. 1-16 (2 pls.).

‡ Centralbl. Bakt. Parasitenk., liv. (1910) pp. 452-4 (2 figs.).

§ Trans. Amer. Micr. Soc., xxix. (1909) pp. 50-64 (2 pls.).

Nervous System of *Polystomum integerrimum*.*—J. André gives a detailed account of the cerebral ganglia and the nerves arising from it. There is more resemblance to what obtains in a rhabdocel Turbellarian than to *Tristomum* or to *Temnocephala*.

Eyes of *Polystomum integerrimum*.†—J. André describes the eyes of the adult parasite, which are very remarkable in showing so little trace of reduction. There is a sensory cell with a "rod-cap," and with a nerve-process to the brain. What is even more remarkable is the presence of a pigment-cup with an associated matrix-cell.

New Species of *Proteocephalus*.‡—G. R. Larne describes *Proteocephalus filaroides* sp. n. from the small intestine of *Amblystoma tigrinum*. The adult tapeworm and the plerocercoid larvæ are both abundant. The facts hint at direct development in one host. The new species is nearly related to *Proteocephalus lönnbergi* in *Necturus maculatus*. Both have a peculiar end-organ, unsegmented neck, a relatively thin and flat strobila, and relatively weak musculature. Their excretory and reproductive systems are much the same.

***Diplogonoporus brauni*.**§—N. Leon reports a second occurrence of this tapeworm (in a Roumanian woman), and gives a description of the specimen. The reproductive organs were immature, as in the first specimen, so that the systematic position of the species remains uncertain.

Parasitic Turbellarians.||—Bruno Wahl describes a new genus, *Umagilla*, in the family Dalyellidæ (Vorticidæ). The diagnosis reads:—Dalyellids with a large doliiform pharynx near the anterior end, compact paired testes, branched yolk-glands, unbranched paired ovary, and a genital opening near the posterior end. The species *U. forskalensis* was found in *Holothuria forskalii*, which also harbours another Dalyellid, *Anoplodium gracile* Wahl. The author has also some notes on *Syndesmis*, another genus in the same family.

North American Turbellarians.¶—Ludwig von Graff gives a preliminary account of a study of North American Turbellarians. He has added 30 to the list of 44 known American species, and 24 of the species are new. Seventeen species are common to Europe and the United States.

Experiments on Cleavage of *Cerebratulus Ovum*.**—N. Yatsu has obtained the following results:—The mode of cleavage is not disturbed by the removal of a portion of cytoplasm, unless the operation is performed close to the beginning of the first cleavage. If a portion of cytoplasm, whether from one or two blastomeres, is removed during the first cleavage, the mode of cleavage is disturbed. Slight injury or a

* Zeitschr. wiss. Zool., xcvi. (1910) pp. 191-202 (11 figs.).

† Tom. cit., pp. 203-20 (13 figs.).

‡ Trans. Amer. Micr. Soc., xxix. (1909) pp. 17-49 (4 figs.).

§ Centrabl. Bakt. Parasitenk., lv. (1910) pp. 23-7 (5 figs.).

|| SB. k. Akad. Wiss. Wien., cxviii. (1909) pp. 943-65 (1 pl. and 2 figs.).

¶ Proc. Seventh Internat. Zool. Congress, 1907 (published 1910) 5 pp.

** Journ. Coll. Sci. Univ. Tokyo, xxvii. (1910) art. 10, pp. 1-19 (4 figs.).

horizontal cut affects the cleavage but little. If the blastomeres are separated by a vertical cut near the end of the first cleavage, partial cleavage takes place as in the blastomeres isolated at the 2-cell stage.

If a portion of cytoplasm is cut off from the vegetal region at the 2-cell stage, the size-relation of the upper and lower cells of the 8-cell stage is normal, irrespective of the angle of the section. In the egg compressed between two planes parallel to the main axis of the egg, the second cleavage is equatorial; and upon relieving the pressure, the third cleavage is vertical and perpendicular to the first.

The following results were obtained from the study of the egg of both *Cerebratulus larteus* and *C. marginatus* :—

In the eggs kept in sea-water without calcium-salts, the third cleavage is vertical, resulting in eight blastomeres arranged either in a ring or in two parallel rows. In the trefoil egg the second cleavage is vertical, giving rise to six blastomeres arranged in a ring. Irrespective of the number of the initial blastomeres (basal cells) formed by vertical cleavages, the division goes on normally in each of them.

Nematohelminthes.

New Nematode from Trinidad.*—R. T. Leiper describes *Lago-chilascaris minor* sp. n., which causes subcutaneous abscesses in natives in Trinidad. The peculiar shape of the three lips, and the presence of a narrow keel-like ridge of cuticle on either side of the body throughout its length, distinguish this form from the three species of *Ascaridæ* known to occur in man, viz. *Ascaris lumbricoides*, *Belascaris mystax*, and *Toxascaris marginata*. The alimentary canal is the normal habitat, and its occurrence in abscesses under the skin renders it likely that some other host—probably one of the Carnivora—and not man, is its normal host.

Rotifera.

Life-cycle of *Hydatina senta*.†—A. F. Shull has made an experimental study of the causes that determine the transition from the parthenogenetic to the sexual mode of reproduction in the Rotifer *Hydatina senta*, and has obtained results which seem to him to go far towards bringing previous contradictory conclusions under a single point of view. He has been able to secure winter eggs and males from the same parent, and finds that, as has long been suspected, male eggs and sexual eggs are identical. His experiments show that the presence of other substances than food in the water exert a strong influence on the inauguration of the sexual phase. To test this influence, the experimenter used water from old cultures, from which the Protozoa had been removed by filtering. This filtrate was used in various strengths, and cultures were also made in pure spring water. The results of the various experiments are tabulated, and in every case the evidence points to the same conclusion: that the filtrate from the old cultures reduces the number of sexual females. A further set of experiments was undertaken to test the apparent effect of starvation. Each time there was a

* Proc. Zool. Soc., 1909, pt. iv. (published 1910) pp. 742-3.

† Amer. Nat., xlv. (1910) pp. 146-50.

considerably higher proportion of sexual females in the starved families. But on the evidence of all the experiments the author concludes that the higher proportion of sexual forms in the starved families is due, not to the lack of food, but to absence of chemicals which, in the well-fed families, prevent the appearance of the sexual forms.

Echinoderma.

Experiment with Sea-urchin Ova.*—Tad. Garbowski has tried to make eggs of *Paracentrotus lividus* unite with those of *Asterias glacialis*, and in doing so observed that the cells sometimes show centrosomes with an extraordinary clearness, as if there had been intra-vitam staining. The two kinds of eggs were shaken together in a centrifugal machine, and it was observed that in the sea-urchin ova, some of which had segmented, there were large bright red centrosomes, just as if they had been stained. This is due, however, to a peculiar aggregation of the characteristic pigment of the *Paracentrotus* ova, which occurs as a sub-equatorial girdle or diffusely.

Indian Ocean Shallow-water Asteroids.†—René Koehler gives an account of the littoral starfishes in the Indian Museum, Calcutta—67 species, of which no fewer than 28 are new. The new species belong to the following genera:—*Luidia*, *Astropecten*, *Dorigona*, *Goniiodiscus*, *Anthenea*, *Pentaceros*, *Asterina*, *Disasterina*, *Nepanthia*, *Chælaster*, *Fromia*, *Ferdina*, *Ophidiaster*, *Linckia*, *Nardoa*, and *Schlerasterias*. The author has paid particular attention to the genus *Pentaceros*.

Cœlentera.

Indian Ocean Alcyonaria.—J. Arthur Thomson and E. S. Russell ‡ report on a collection of Axifera made by J. Stanley Gardiner. There are 50 species, of which 11 are new. The following are some of the points of interest. A variety of *Plumarella delicatissima*, previously obtained from the west coast of Patagonia, was found at Providence. Interesting new species of *Calicogorgia* have afforded material for making a clearer distinction between this genus and the nearly related *Anthogorgia*. In *Calicogorgia rigida* sp. n. the polyps contained numerous embryos, about 1 mm. in diameter. The somewhat divergent *Echinogorgia ramosa* sp. n. seems to connect its genus with *Anthogorgia*. The species *Bebryce mollis* Philippi should include *B. philippi* Studer and *B. studeri* Whitelegge; it is found from the Mediterranean to Funafuti. Many striking examples of "convergence" and of colour-variability are seen in the collection. An artificial key is given for the species of the genus *Acis*.

J. Arthur Thomson and Doris L. Mackinnon§ report on the Stolonifera, Alcyonacea, Pseudaxonia, and Stelechotokea, of the same collection, dealing with 76 species, of which 13 are new. A remarkable

* Bull. Internat. Acad. Sci. Cracovie, 1910, pp. 95-110 (8 figs.).

† Echinoderma of Indian Museum, pt. vi. (Calcutta, 1910) 191 pp. (20 pls.).

‡ Trans. Linn. Soc. London (Zool.) xiii. (1910) pp. 139-64 (4 pls.).

§ Tom. cit., pp. 165-211 (5 pls.).

and puzzling form, *Sympodium salomonense* sp. n., spreads as a membrane over weathered coral. The puzzling *Bellonella indica* Thomson and Henderson is really a species of *Erythropodium* (a sub-genus of *Alcyonium*). The difficult form *Paranephthya pratti* Thomson and Henderson requires a new genus, for which the name *Sclerella* is proposed. It is probably an annectent genus, like *Dactylnephthya*, *Cactogorgia*, *Agarioides*, and *Studeriotis*, binding together Alcyonids, Nephthyids, and Siphonogorgids. In *Stereonephthya macrospiculata* some of the spicules attain the length of 1 cm., the longest and strongest Alcyonarian spicules as yet recorded. The authors believe that *Chironephthya* must be merged in *Siphonogorgia*. Simpson's interesting genus *Cactogorgia* finds another representative, *C. lampas* sp. n. The contrast between *Melitodes* and *Wrightella* is defined.

Telesto rosea.*—Kumao Kinoshita describes a peculiar structure in the main stem of this species. When the colony reaches a certain size a new zone of spicules is laid down from the base upwards, outside what has been already formed, and gradually a zoned structure results. As many as six rings may be seen separated by zones of mesogloea without spicules, and penetrated by longitudinal solenia.

Development of Lucernarids.†—W. Wietrzykowski has studied in particular *Halicystus octoradiatus*. The eggs and sperms are liberated simultaneously about eight o'clock in the evening in July and August. There are two polar bodies, and the first cleavage forms two almost equal blastomeres. The whole segmentation is total and equal; a planula is formed with the endodermic cells radially disposed around the future axis. After a short period of free life the planula fixes itself and several stages are described, the oldest reared having four tentacles.

Cleavage of Ctenophore Ovum.‡—N. Yatsu has studied the egg of *Beroë* and made experiments on its cleavage. The ovum shows an extraordinary structure, while its cleavage belongs to a rather common type. The central mass is a watery alveolar substance. There is a shallow vegetative furrow and a lateral elongation of the egg. The "cleavage head" is formed at first as a shallow indentation. As it grows deeper, beautiful spinings of hyaloplasm are to be seen along the walls. The cleavage head is a saddle-like thickening of ectoplasm, with a fine alveolar structure. Rays can be seen it, but they do not extend into the entoplasm. Below are found compressed alveoli of entoplasm. This shows clearly that the cleavage head is itself actually pushing downwards. "The egg of *Beroë* is cut by the contraction of the saddle-like (in later stages ring-shaped) accumulation of ectoplasm (the cleavage head in optical section) uninfluenced by other structures, such as nuclei, centres, and amount of cytoplasm."

Ontogeny and Phylogeny of Hydroids.§—Alfred Kühn discusses the development of the reproductive polyps in Corynidae, Cladonemidae,

* Annot. Zool. Japon, vii. (1910) pp. 209-11 (1 fig.).

† Arch. Zool. Expér., v. (1910) Notes et Revue, pp. x.-xxvii. (12 figs.).

‡ Proc. Seventh Internat. Zool. Congress, 1907 (1910) 4 pp. (4 figs.).

§ Zool. Jahrb., xxx. (1910) pp. 42-174 (8 pls. and 16 figs.).

Pennaridæ, Tubularidæ, Clavidæ, Bougainvillidæ, and Campanularidæ. The comparative morphology of the colonies that form gonophores and the comparative embryology of the gonophores lead to the conclusion that the evolution of Athecata and Thecophora alike started from forms which had already established an alternation of generations between sedentary polyps and free-swimming sexual individuals. The latter had the general structure and typical development of medusoids. Probably also the ancestral forms showed tetramerous symmetry.

The typical stages in medusoid-development are the following: (1) The formation of the ectodermic "glockenkern" (sub-umbrellar primordium) and the endodermic radial diverticula (primordium of the umbrellar endoderm); (2) the formation of the velar plate from the roof of the bell-cavity, the manubrium, etc.: and (3) the formation of the marginal organs and tentacles, and the liberation of the velum.

In diverse groups a reduction of the free-swimming medusoids has come about, and the stages "eumedusoid," "cryptomedusoid," and "heteromedusoid" may be distinguished, leading eventually to a simple diploblastic sexual bud (styloid gonophores). Most of the gonophores are demonstrably reduced medusoids. In a few cases it is doubtful whether the gonads are produced from much reduced gonophore buds (medusoid buds), or from modified polyp-buds, or are simply organs arising de novo on polyps.

New Genus of Unstalked Hydroids.*—A. H. Clark describes *Comatilia irido-metriformis* g. et sp. n., a peculiar form from deep water between the Bahamas and North Carolina. According to the structure of its oral pinnules and brachials it belongs to the Comasteridæ. Judged upon its other characters it might be placed in the Antedonidæ, Himero-metridæ, Thalassometridæ, or Tropiometridæ. Certain features find a parallel only in *Rhizocrinus* and *Bathycrinus*. On the whole it is a Comasterid.

Porifera.

Reactions of Sponges †—G. H. Parker has made a series of interesting experiments with *Stylotella heliophila* Wilson, a monaxonid demosponge, and gives the following summary of his results.

Under natural conditions *Stylotella* closes its oscula and contracts its flesh when, at low tide, it is exposed to the air. Its outer surface is perforated by many ostia which lead to large sub-dermal cavities; these in turn connect through incurrent canals with the flagellated chambers from which excurrent canals pass to the gastral cavity and the osculum.

The flesh of *Stylotella* contains many myocytes, which are arranged as sphincters around the ostia, internal cavities, and osculum. These sphincters apparently work against the general elasticity of the flesh and not against radiating systems of myocytes. The oscula close in quiet sea-water, on exposure to air, on injury to neighbouring parts, in solutions of ether (0.5 p.c.), chloroform (0.5 p.c.), strychnine ($\frac{1}{3000}$).

* Proc. U.S. Nat. Museum, xxxvi. (1909) pp. 361-73 (1½ pl.).

† Journ. Exper. Zool., viii. (1910) pp. 1-41 (3 figs.).

cocaine ($\frac{1}{10000}$), and in de-oxygenated sea-water. They contract but do not close in diluted sea-water and at temperatures higher than normal (35° to 45° C.). They remain open in currents of sea-water, and their closure is inhibited by solutions of cocaine ($\frac{1}{10000}$) and of atropine ($\frac{1}{1000}$), and in fresh-water. They are apparently uninfluenced by low temperatures, by weak solutions of cocaine ($\frac{1}{30000}$), and of atropine ($\frac{1}{10000}$), and by light. The ostia close on injury to neighbouring parts, in solutions of ether (0.5 p.c.), chloroform (0.5 p.c.), strychnine ($\frac{1}{15000}$), and cocaine ($\frac{1}{1000}$). They open in solutions of cocaine ($\frac{1}{10000}$), and of atropine ($\frac{1}{1000}$), in dilute sea-water, de-oxygenated sea-water, and warm sea-water (35° C.). They are apparently unaffected by mechanical stimulation, except injury, by low temperature, and by light. The choanocyte currents cease in solutions of ether (0.5 p.c.), and of chloroform (0.5 p.c.), in diluted sea-water, and at high temperatures (40° to 45° C.). They become slow at low temperatures (9° to 10° C.), and fast in solutions of strychnine ($\frac{1}{15000}$). In de-oxygenated water they first become fast and then cease.

The flesh of *Stylotella* is capable of contraction, but such contraction gives the sponge only a shrivelled appearance, without changing its general form. The currents in *Stylotella* are constant in direction and give no evidence of reversal. They are controlled by the ostial and oscular sphincters. They produce a pressure equivalent to 3.5 to 4 mm. of water. The pressure necessary to break through the closed ostia is 10 to 15 mm. of water, and through the closed oscula somewhat more. The reactive organs of *Stylotella*, the ostia, the oscula, the flesh, and the choanocytes, are all more or less independent of one another, and their action is changed by direct stimulation. In the ostia, oscula, and flesh contraction is accomplished by spindle-shaped cells, the myocytes, which resemble primitive smooth muscle-fibres. The body of *Stylotella* is almost without transmission, and such transmission as is present is so sluggish in character and so slight in range as to resemble transmission in muscles and not in nerves. It is probable that *Stylotella* possesses no organs that can reasonably be called nervous. The nervous and muscular systems of Metazoa were not differentiated simultaneously (Kleinenberg, Ö. and R. Hertwig), nor independently (Claus, Chun), but muscles, independent effectors, as represented by the sphincters of sponges, were the first of the neuro-muscular organs to appear, and these formed centres around which the first truly nervous organs, receptors, in the form of sense-cells, developed, giving rise to a condition such as is seen in the Coelenterates to-day. To this receptor-effector system as seen in modern Coelenterates was added in the higher Metazoa the adjuster or central organ, thus completing the essential parts of the neuro-muscular mechanism as seen in the higher Metazoa.

Fresh-water Sponges from the Philippines and Australia.* — Nelson Anandale describes *Spongilla sceptrioides* Haswell (New South Wales and Queensland), a close ally of *S. lacustris*, and two new species, *S. philippensis* (Philippines), and *S. clementis* (Philippines).

* Proc. U.S. Nat. Museum, xxxvi. (1909) pp. 627-32 (4 figs.).

Protozoa.

Adaptation and Immunity of Infusorians to Ethyl-alcohol.*—J. Frank Daniel has studied the acclimatization of Infusorians to ethyl-alcohol, and the effects of this acclimatization on their resistance to other chemicals. His chief conclusions are thus summarized :—

In certain strains of *Stentor caruleus*, and in *Spirostomum ambiguum*, it was found that living for a few days in 1 p.c. ethyl-alcohol increases the resistance of the animals to a stronger solution of the same substance—ethyl-alcohol. This increased resistance is shown (1) in the fact that the organisms are not so quickly killed in a lethal solution; (2) in the fact that they may continue to live in a stronger solution—stronger than that in which they could live before acclimatization. Different species of Infusoria and different strains of the same species, living under dissimilar environmental conditions, showed various degrees of normal resistance to alcohol, and very different capacities for becoming acclimatized to it.

In *Stentor caruleus* one strain, designated as E, manifested a high normal resistance, but this resistance was increased little or not at all by remaining in 1 p.c. alcohol; while another strain F, had a low normal resistance, which was readily increased by living in a weak acclimatizing medium.

Incidentally, similar differences in the resistance of different sorts of Infusoria to other chemicals were observed. Thus, *Spirostomum* withstood about eight times as concentrated a solution of hydrochloric acid as did *Stentor*. Marked differences are likewise observable among individuals of the same culture when tested for resistance to different chemicals.

Acclimatization to alcohol is shown not alone in an increase of resistance to a stronger solution, but in changes in the behaviour of the organisms. The unacclimatized animal responds to the stronger chemical by powerful motor reactions, while the acclimatized organism shows much slighter activity. In a weak solution of alcohol (1 p.c.) the beginning of acclimatization is usually evident within a few hours. This increases in a fairly uniform ratio until about the fourth day, at which time a maximum degree of immunity may be expected. The degree of resistance produced corresponds in a measure to the strength of the alcohol used as an acclimatizing medium. As compared with the resistance produced by a 1 p.c. medium, that due to $\frac{1}{2}$ p.c. is lower in degree. In a medium much stronger than 1 p.c. the correspondence does not hold, since stronger solutions decrease the resistance by producing injury to the organism.

The fact that in these experiments some strains show little or no capacity for becoming acclimatized to alcohol although tried for long periods of time and with refined methods, makes it questionable whether acclimatization takes place so readily and to so high a degree as is commonly supposed. Tolerance, or acclimatization, to ethyl-alcohol does not increase the resistance of the organisms to other chemicals. On the contrary, it usually renders the animals less resistant to other agents. This matter was studied in detail in *Stentor* and *Spirostomum*

* Journ. Exper. Zool., vi. (1909) pp. 571–611.

for an acid, an alkali, and for two substances belonging to the group of alcohols—namely, glycerin and methyl-alcohol. In all cases the animals which had acquired an increased resistance to ethyl-alcohol as a result of living in a 1 p.c. solution showed no increase, or an actual decrease of resistance to other chemicals. Thus the immunity produced by ethyl-alcohol is specific; it does not produce protection against all chemicals.

Study of Lophomonas.*—C. Janicki describes the structure, division, and encystation of *Lophomonas blattarum* Stein and *L. striata* Bütschli, two remarkable parasitic Flagellates in the hind-gut of the cockroach. The genus is most nearly related to *Jania*, *Trichonympha*, and *Microjenia*.

Hastatella radians.†—P. de Beauchamp and B. Callin discuss this interesting free Vorticellid, which is characterized by the presence of two crowns of peculiar sharp "fulcra"—delicate pointed prolongations which perhaps aid in flotation.

Protozoon Parasites in Blood of Fishes.‡—R. O. Naumann has studied Mediterranean and Adriatic fishes, especially ground-fishes. About 3-4 p.c. had blood-parasites—Hæmogregarines, Trypanosomes, etc. Spirochaets were found in *Galus minutus* and *Pelamys sarda*. Two new types are described, *Gobidium multifidum* from *Gobius minutus* and *Arnoglossus grohmanni*, and *Immanoplasma scylli* from the dog-fish, *Scyllium canicula*.

Studies on Amœbæ.§—A. Schepotieff has studied in the first place the marine *Amœba flava* Gr., and describes the following stages: large multinucleate forms (= *Pelomyxa*-stage), multinucleate cysts in which the nuclei form chromidia and secondary nuclei arise, swarm-spores (isogametes), conjugation, mononuclear forms. In the second place he describes a species of *Nucleophaga*, a parasite of marine Amœbæ. Its stages resemble Prowazek's Chlamydozoa, which are said to be the causes of variola, scarlet fever, hydrophobia, and many other diseases. Schepotieff distinguishes stages in normal nuclei, in hypertrophied nuclei, and in the cytoplasm. He presumes that there are also stages free in the water which spreads the infection. It spread like an epidemic among his Amœbæ.

New Genus of Arenaceous Foraminifera.||—J. A. Cushman describes *Ammodiscoïles turbinatus* g. et sp. n., from 1181 fathoms in the Gulf of Mexico. The genus is split off from *Ammodiscus*, which is plano-spiral both in the young and in the later stages, while *Ammodiscoïles* is definitely conical when young. The entire spiral test consists of as many as thirty coils, the later portions becoming usually conical in the opposite direction from that of the younger portion.

* Zeitschr. wiss. Zool., xcv. (1910) pp. 243-315 (4 pls. and 16 figs.).

† Arch. Zool. Expér., v. (1910) Notes et Revue, No. 1 (pp. xxviii-xxxiii (2 figs.)).

‡ Zeitschr. Hygiene u. Infectiousk., lxiv. (1909) pp. 1-112. See also Centralbl. Bakt. Parasitenk., xlvi. (1910) pp. 323-5.

§ Zool. Jahrb., xxix. (1910) pp. 485-526 (1 pl.).

|| Proc. U.S. Museum, xxxvi. (1909) pp. 423-4 (1 pl.).

BOTANY.

GENERAL,

Including the Anatomy and Physiology of Seed Plants.

Structure and Development.

Vegetative.

Anatomical Study of the Mangifereæ.*—M. A. Goris publishes a contribution to the systematics of this tribe of Anacardiaceæ, based upon anatomical characters. Referring to the previous work of Jadin, the author finds that the leaf (always simple), rather than the stem, is important for the diagnosis of genera.

The tribe includes the following genera, grouped in accordance with floral characters :—

- A. Five free carpels, only one fertile *Buchanania*.
 B. One carpel only.
 (a) Leaves alternate.
 i. Stamens 10–5, 4–1 fertile, the others aborted.
 1. Pedicel swollen under the fruit . . . *Anacardium*.
 2. Pedicel not swollen under the fruit . . . *Mangifera*.
 ii. Stamens 3, all fertile; drupe globular, ovoid.
 1. Petals sessile, not accrescent . . . *Gluta*.
 2. Petals accrescent under the fruit . . . *Swintonia*.
 iii. Stamens numerous; petals accrescent . . . *Melanorrhœa*.
 (b) Leaves opposite *Bouea*.

The anatomical structure of all these is essentially of one type, the differences being secondary only, but of value in differentiating the genera. This anatomical grouping, moreover, is in accord with that based on floral characters. *Buchanania* is characterized by the presence of mucilage in the cells of the leaf-epidermis, which are of a peculiar form. The stem differs from that of the other genera in the smallness of the amount of cortical sclerenchyma, and the presence of bast-fibres, which divide the bast into several zones. *Swintonia* is readily distinguished by the papillæ which occur on the leaf-epidermis. The shape and structure of the leaf suggest affinity with *Buchanania*, the two being isolated from the rest of the tribe. *Anacardium* differs from the other genera in having secretory canals in the cortex of stem and leaf-petiole. The arrangement of the stomata is also characteristic. *Bouea* is distinguished by the presence of sclerotic cells in the mesophyll, the absence of secretory canals in the pith, and the arrangement of the vascular bundles in the petiole and main vein, which tend to remain

* Ann. Sci. Nat. Bot., xi. (1910) pp. 1–29 (figs.).

separate, each set from the other. *Melanorrhœa* has a leaf with sclerenchymatous hypoderm, 1-layered; the vascular bundles are joined by bands of sclerenchyma; and there are numerous glandular hairs. *Gluta* has a 2-layered leaf hypoderm; bundles isolated; and glandular hairs are uncommon.

The two last-named genera seem to approach *Mangifera* in their affinities, through the species *M. fatida*, *M. andamica*, and *M. quadrifida*, in which a single-layered sclerenchymatous hypoderm is present. *M. Reba*, with secretory canals in petiole and principal leaf-vein, indicates connexion with *Anacardium*, as also do *M. cœsia* and *M. lagenifera*: these two latter, moreover, with sclerotic elements in the leaf-mesophyll, approach *Bouea*, and this is substantiated by the isolated condition of the vascular bundles in these two species. *Mangifera* seems, therefore, to represent a central synthetic type, combining in its several species the anatomical characters met with in the other genera.

Branch Types and the Age of Trees.*—M. Jean Daniel, in a note, points out that certain trees bear three kinds of branch. 1. Long branches, with elongated annual shoots separated by bud-scars arranged at relatively long intervals. 2. Short branches, with dwarfed annual shoots, the separating bud-scars being more or less crowded. 3. Mixed branches, composed of an irregular succession of long and short shoots. Two general types emerge, the Beech type and the *Ginego* type. The author concludes from his study of these that the short branch differs from the long branch in having a relatively small amount of wood, in the absence of annual rings, in the fewness of medullary rays, and in the abundance of parenchymatous tissue. The mixed branch has similar characters, but the difference from the long branch is less accentuated. When the tree has attained its maximum growth, it produces only short and mixed branches, and consequently the annual growth-increase is not clearly defined from that time forward.

These considerations point to the impossibility of determining the age of a plant with any approach to accuracy by observing the number of "annual" rings. For more than one ring may be formed in a year if the conditions are changed in certain ways; where the rings seem quite clear, again, their formation may last only for a limited time, and in some cases the rings are very indistinct.

Physiology.

Nutrition and Growth.

Function of the Endodermis and Selective Absorption by Protoplasm.†—J. de Ruzf de Lavison publishes some interesting experiments and conclusions relative to the details of root-absorption of certain salts. The substances used were sulphate of iron, which cannot pass through living protoplasm, and sulphocyanide of ammonium, which can. Some striking drawings of magnified root-sections are given; and it seems clear that the suberized frame-work round the typical endodermal cell is impermeable, so that every salt-solution which enters the

* Comptes Rendus, cl. (1910) pp. 1611-13.

† Rev. Gen. Bot. xxii. (1910) pp. 225-41 (figs.).

plant must pass the protoplasm of the endodermis, for it cannot permeate the walls.

The endodermis thus functions as a living membrane, completely surrounding the central cylinder of the root. This membrane, the present experiments prove, exercises a distinct selective power, which is not merely quantitative, dependent upon the strength of the solutions concerned, but qualitative also. The author points out, however, that this latter selective power appears to be of little use to a plant growing in normal conditions—for the soil does not contain substances incapable of penetrating the protoplasm.

Youth-form of Leaves and its Significance.*—Th. Nicoloff discusses the phyletic significance of the form adopted by young leaves of certain plants, either in seedlings (*Pothos celatocaulis*, *Acer Negundo*, *Fraxinus excelsior*, etc.), or on mature branches, normal or adventitious (*Juglans*). He concludes that this youth-form does not invariably afford a criterion of affinity. In some cases it is due merely to special conditions of environment (*Pothos*), and change in leaf-shape on normal branches may be induced by change in the environment, as shown by certain experiments of Goebel; in other cases, such as certain aquatic monocotyledons, the phenomenon is not so readily explained. But there is no doubt that in some instances some connexion exists between the youth-form of leaves and the normal leaf-form of allied species, particularly in the case of leaves which arise upon adventitious branches. The author suggests that during the formation of a species, the new specific characters, which are the expression of a changing environment, appear first in the later stages of ontogeny, gradually working back, in the process of time, to the earlier stages. The earliest stages of ontogeny may thus tend, in certain cases, to lack new characters, and so display the ancestral characters. In some cases, even, where evolutionary progression has not advanced too far, the ancestral form may be induced by a return to the old conditions—as Goebel's experiments show—but this is not often the case. Adventitious buds are endogenous, arising from the pericycle; this tissue, being deep lying, is not effectively exposed to the new environmental conditions, and so retains for a relatively long period the disposition to "revert" to ancestral characters.

The "youth-form" displayed by leaves on adventitious branches, then, affords the safest guide to ancestry.

Osmotic Pressure in Plants.†—H. H. Dixon and W. R. G. Atkins describe a new method of determining the freezing-point of small quantities of liquid with accuracy by a thermo-electric process; this they apply to the sap of various plants, and thence calculate the osmotic pressure. The relation between the latter (P) and the consequent depression (Δ) in the freezing-point of the sap has been given by Nernst as $\Delta \times 12 \cdot 08 = P$, in atmospheres. The authors conclude that osmotic pressures are variable with the species and individual alike, and the variation in the same individual under varying circumstances may be very considerable—e.g. 24·58 atm. to 11·58 atm. in Lilac. Leaves of the same individual under similar conditions have the same osmotic

* Rev. Gen. Bot., xxii. (1910) pp. 113–24 (figs.).

† Proc. Roy. Soc. Dublin, xii. (1910) pp. 275–311 (fig.).

pressure. The variation is probably due chiefly to fluctuation in the carbo-hydrate content of the cells, and is not defined by the height of the leaves above the ground, nor by the resistance of the conducting tissue; the osmotic pressure is in any case much greater than the tension of the water supply could have been.

Photosynthesis leads to increase in osmotic pressure, and a similar but smaller increase occurs in plucked leaves stored in darkness, because of the hydrolysis of saccharose and starch. Shielding leaves from the light leads to fall in osmotic pressure—e.g. 18 to $11\frac{1}{2}$ atm. Mature leaves showed higher pressure than developing ones, and the pressure in roots is relatively low (4 to 6 atm.). The greatest osmotic pressure observed was 26·87 atm., in Lilac, but this is probably by no means a maximum for this plant. The lowest record was 3·79 atm., in *Chamærops humilis*.

Ascent of Sap in Trees.*—Leclerc du Sablon points out the unsettled state of this problem, and objects to previous explanations based on the assumption of a difference of pressure between the two ends of the stem on the score that no cause can be ascertained to account for a difference of pressure sufficient to raise water from the roots to the summit of a tall tree. Bonnier has shown that pressure-differences can be transmitted for only a very short distance in the interior of the wood, and Ewart has demonstrated the great resistance offered by the vessels on account of their fine bore, and the presence of cross-walls and of groups of air-bubbles (Jamin chains).

The author suggests that the water-current is maintained by the osmotic power of the living cells of the wood. The leaf-cells transpire, their osmotic power increases and turgescence diminishes; they therefore take water from the neighbouring vessels in which the pressure will be less than atmospheric. This pressure-effect, we have seen, cannot reach far, but it can reach at least the neighbouring living cell; the equilibrium between this and the vessel will then be broken, and sap will pass into the vessel. This process is repeated from living cell to living cell, and water circulates throughout the organism, quite independently of its bulk. The necessary force is thus derived from increase in osmotic pressure, and all causes which, like transpiration, influence the osmotic strength, contribute to the ascent of the sap.

Irritability.

Influence of Light upon Fruit- and Seed-development.†—M. Lubimenko publishes the results of various experiments in this connexion, performed with *Colutea arborescens*, *Pisum sativum*, *Lathyrus latifolia*, various Rosaceæ, and other plants. The author concludes:—
1. That a closed atmosphere is necessary for normal seed-development, the oxygen necessary for respiration being derived from the photosynthetic activity of the pericarp wall; and this necessity extends probably to the first stages of embryo development. 2. Mechanical pressure of the surrounding tissues plays a significant part in limiting embryo development. 3. A certain intensity of illumination is indispensable to the initiation of fruit development. Darkness prevents the formation of

* Comptes Rendus, cli. (1910) pp. 154-7.

† Rev. Gen. Bot., xxii. (1910) pp. 145-75 (figs.).

seed, and leads to the death of the entire fruit. The most favourable intensity, moreover, is relatively low. The light-function in this connexion has nothing to do with photosynthesis; it is a direct influence, operating in the direction of cell-nutrition by organic substances, probably on account of the importance of light in the elaboration of diastases—as has been established by Reynolds Green. The author draws attention to the analogy between this influence of light and the similar influence exerted upon the development of growing points. 4. When once an adequate supply of enzymes has been formed, embryo development may proceed favourably in complete darkness; but at the same time the production of dry substance in the fruit, and also the number of seeds, is appreciably lessened if development proceeds in darkness. 5. Darkness, therefore, results in enfeebled fruit-development; and the same result follows if, on the other hand, the illumination exceeds a certain intensity. Even ordinary daylight is somewhat too intense to be the most favourable in this regard. 6. Light has an appreciable effect upon the chemical composition of the fruit-substance. The experiments show that the amount of ash in the case of certain fruits increases as the illumination during development decreases; and also that light has its effect upon the formation of sugars and acids, the acidity of the fruit diminishing in proportion with the intensity of illumination. 7. Seed-germination is most active either in darkness or under the same light-conditions which prevail during seed-formation.

The author concludes by pointing out the practical value of such experiments in fruit culture.

CRYPTOGAMS.

Pteridophyta.

(By A. GEPP, M.A. F.L.S.)

Development of *Angiopteris* and *Kaulfussia*.*—D. H. Campbell gives an account of the embryo and young sporophyte of *Angiopteris* and *Kaulfussia*. The Marattiales are of special interest as showing the nearest relationship to the Ferns and Pteridosperms of the Palæozoic period. Existing Marattiales comprise only about thirty species, distributed in five genera. *Angiopteris*, *Kaulfussia*, and *Archangiopteris* are monotypic genera. *Danæa* contains about fifteen species, *Marattia* about twelve. Campbell collected prothallia and young sporophytes of *Angiopteris evecta* in Ceylon, and of *Kaulfussia æsculifolia* in Java; also prothallia of three species of *Danæa* in Jamaica. In order to fill up some gaps in our knowledge of the young stages of these rare ferns, he prints the present contribution. He sums up his results as follows: 1. Probably in all Marattiaceæ the stem, leaf, and root all arise from the epibasal part of the embryo; in *Danæa* the primary hypobasal cell forms a suspensor, and all of the organs, including the foot, are of epibasal origin. 2. In *Kaulfussia* and *Angiopteris* the stem and leaf do not take up all of the epibasal tissue; a portion also contributes to the foot. 3. The stem apex usually shows a single large initial cell, which possibly may be derived directly from one of the primary quadrants of

* Ann. Jard. Bot. Buitenzorg, 3^e Suppl. (1910) pp. 69–82 (2 pls.).

the embryo; the cotyledon cannot certainly be traced back to one of the primary quadrants, and does not seem to be always formed from the same portion of the embryo; the cotyledon does not show a definite apical cell. 4. The root arises secondarily, is endogenous in origin, and is practically always of epibasal origin. It grows from a single initial cell. 5. The foot is very large in the young embryo, but later is almost obliterated by the growth of the root. 6. No vascular cylinder is formed in the stem region of the young sporophyte; the vascular bundle of the leaf is continued without interruption with the root, and the young sporophyte appears bipolar, the leaf growing upward, the root downward. 7. The bundle of the leaf petiole is concentric, that of the root diarch. 8. The vascular system of the stem of the young sporophyte is built up of the leaf traces alone. No strictly cauline bundles occur in the early stages of the sporophyte.

Fossil Marattiaceæ.*—F. Krasser publishes diagnoses of the species of Marattiaceæ noted by the late Dionysius Stur in the Upper Trias flora of Lunz. Of the seventeen species described, ten are new and known only from Lunz. All the species belong to fossil genera (seven in number), which are valid genera on the score of their sporangia. The fossil Marattiaceæ of the Keuper of Lunz thus show an extraordinary degree of differentiation.

Fossil Osmundaceæ.†—R. Kidston and D. T. Gwynne-Vanhan have published a third instalment of their studies of the fossil Osmundaceæ. Inter alia, they give an account of *Thamnopteris Schlechtendalii* Eichwald. They find the middle of the stele to be occupied by a mass of short tracheids without admixture of parenchyma. Their view that this is to be regarded as the equivalent of a pith is combated by E. C. Jeffrey.‡

Stele of *Osmunda cinnamomea*.§—J. H. Faull has examined much material of the sporelings of *Osmunda cinnamomea* in all stages, and sums up his results as follows. The cortical cells at the base of the sporeling are inhabited by a fungus. Despite individual variations, in no case is the transition from protosteles to siphonosteles effected by a simple expansion, as has been claimed for Osmundaceæ. There are bays or gaps in the xylem near the nodes, which may result in enclosing a "stellar" pith. Rarely, and only in adult stems, does the internal endodermis and "extra-stellar" pith connect with the external endodermis and cortex through the leaf-gaps. Internal phloem has been found in unbranched adult plants, and this fact, together with the absence of branching in the sporeling, is thought to indicate that internal phloem and internal endodermis in this family have not "intruded" through branch gaps. The general conclusion is that the stele of the existing Osmundaceæ is a "reduced amphiphloic siphonostele," and that it is consistent with Jeffrey's theory of the origin of the siphonostele and the homology of the pith.

* SB. k. Akad. Wiss. Wien, cxviii. (1909) pp. 13-43.

† Trans. Roy. Soc. Edinburgh, xlvii. (1909) pp. 651-67 (8 pls.).

‡ Bot. Gaz., l. (1910) p. 74.

§ Trans. Canadian Inst., viii. (1909) pp. 515-34 (3 pls.). See also Bot. Gaz., xlix. (1910) pp. 475-6.

Fossil Osmundaceæ and Zygopterideæ.*—W. T. Gordon writes on the relation between the fossil Osmundaceæ and the Zygopterideæ. Anatomically they are almost indistinguishable; and this fact, taken in conjunction with their geological positions, points to the conclusion that the Zygopterideæ diverged from the parent stock before the Osmundaceæ did, and subsequently dropped out of existence.

Fossil Ferns of France.†—O. Lignier publishes a sixth paper on the fossil plants of Normandy, treating of the Jurassic flora of Mamers (Sarthe). The Pteridophyta are represented by *Lomatopteris*, *Linopteris*, *Equisetites*.

F. Pelourde ‡ publishes observations on some fossil plants of the Autun strata, namely, *Stipitopteris* sp. and *Botryopteris antiqua*, which he describes and compares with other known specimens.

Suspensor in Helminthostachys.§—W. H. Lang indicates in a note the discovery of a suspensor in *Helminthostachys zeylanica*. The suspensor is multicellular, two tiers being visible. It closely resembles the suspensor of *Botrychium obliquum*, but is attached to the prothallus by a large foot. The possession of a suspensor is not a peculiarity of the Lycopodiales, but has been demonstrated in *Botrychium*, *Helminthostachys*, and *Dunæa*.

Schizoneura paradoxa.||—R. D. Vernon gives a description of fragments of *Schizoneura paradoxa* Schimper and Mougeot found in the Bunter of Nottingham, an Equisetaceous plant of exceptional interest as being the first evidence of contemporary life in the Bunter rocks of England.

L. J. Wills ¶ publishes some notes on the genus *Schizoneura*, and shows that the species fall into two groups—*Neocalamites* and *Schizoneura* proper—but what relation these bear to the Calamites and to the modern *Equisetum* must remain a secret until more is known of the internal structure and of the fructification.

Assimilating-tissue of Fossil Ferns (Calamites).**—H. H. Thomas describes the assimilating tissues of some Coal Measure plants, especially those of the *Calamocladus* section of the Calamites. The leaves are small, short, cylindric, and were borne in whorls on long, slender, pendulous stems. The central vascular bundle is surrounded by the bundle-sheath and then by palisade tissue, the isolated cylindric cells of which are situated radially. The air-spaces being very large, the mesophyll is very spongy. The stomata are confined to the adaxial (probably lower) side of the leaves. The stomata closely resemble those of *Equisetum*. The bundle-sheath is rendered conspicuous by the large mass of its opaque carbonaceous contents. No phloem nor sieve-tubes are obvious. The bundle-sheath doubtless functioned as the path of conduction for the products of assimilation in these small leaves. The

* Proc. Cambridge Phil. Soc., xv. (1910) pp. 398-400.

† Mém. Soc. Linn. Normandie, xxiv. (1910) 48 pp. (pls. and figs.).

‡ Ann. Sci. Nat., xi. (1910) pp. 361-71 (figs.).

§ Ann. Bot., xxiv. (1910) p. 611.

¶ Proc. Cambridge Phil. Soc., xv. (1910) pp. 401-5.

¶ Tom. cit., pp. 406-10.

** Proc. Cambridge Phil. Soc., xv. (1910) pp. 413-15.

smallness of the leaves was probably compensated for by their multitude. The author finds that there was considerable variety in the respective assimilating systems of the different members of the Carboniferous flora.

Prothallial Development in Lycopodium.*—H. Bruchmann gives an account of the germination of the spores and of the development of the prothallium of *Lycopodium clavatum*, *L. annotinum*, and *L. Selago*. Now for the first time there is some information on these matters. The resting-period of the spores is very prolonged; extending to some three to seven years. An unusually small number of spores germinate. The reticulate spores of *L. clavatum* and *L. annotinum* belong to an entirely different section of the genus from that which contains the papillate-spored *L. Selago*; and they produce quite different types of prothallium, which, however, are similar in development. Both the kinds of spores develop independently of fungi, until they consist of five cells, but thereafter they are dependent on association with fungi throughout life. The first sign of germination in the spore is the formation of a lenticular cell, which, as in other Pteridophyta, means a rudimentary rhizoid.

The first stage in the development of the prothallium is an egg-shaped body with two-sided apical cell. In a later stage it differs from all known forms, but is subject to the influence of geotropism. In the second stage of development both forms of prothallium present a radial pear-shaped appearance, and have a meristematic growing-point. The two types now diverge: in the *L. clavatum* type the prothallium grows slowly, is highly differentiated and capable of resistance; that of *L. Selago* is simpler, grows and disappears more quickly. The third and last stage is accompanied by a change from apical to marginal growth, and by the formation of an axial-conducting tissue from a secondary meristem of the middle of the apex. Finally, the middle of the apex is converted into generative tissue and sexual organs, and assumes a dorsiventral mode of growth. In this stage the prothallium exhibits inflorescences and buds. In both types of prothallium the fungus-association inhabits the whole cortical tissue, and is intracellular; in *L. clavatum* it is intercellular in the inner layers. The endophytic fungi differ in shape in the two types. In the *L. clavatum* type the fungus forms balls in the cells, and can pass in and out as it chooses. In the *L. Selago* type the fungus enters the cells in the form of mycelial threads and sporangioles; one single infection is enough for the whole lifetime of the prothallium, but the fungus attains a regular communication with the substratum through the rhizoids. The fungus-association in both types brings about a good acquisition of food-stuffs, especially a rich storing of starch. *L. complanatum* belongs to the *L. clavatum* type in its prothallium and embryo. *L. Selago* belongs to the type of *L. Phlegmaria*.

Lycopodium Selago: a curious habitat.†—J. W. H. Trail notes the finding of this species on the decaying thatch of an old cottage up the Dee valley. It had produced sporangia and separable buds in plenty. The species has become scarce in the neighbourhood of Aberdeen, owing to the drainage and cultivation of the peaty moors.

* Flora, n.s., i, (1910) pp. 220-67 (figs.).

† Ann. Scottish Nat. Hist., No. 75 (1910) pp. 185-6.

Stomata of *Lycopodium annotinum*.*—J. Borodine publishes a note on the remarkable distribution of the stomata on the leaves of *Lycopodium annotinum*. Each annual shoot exhibits a regularized variability in the relation between the number of stomata on the upper and under surfaces of the leaves. The 1-4 basal leaves have stomata on the upper surface only; in the successive leaves stomata are found on the under surface, and their number on the under surface becomes larger and larger. They first appear near the basal margin and gradually cover the whole surface except the costa. On the upper leaves they rapidly diminish to zero. Also most of the leaves formed in summer possess stomata on the under surface only. But towards the end of the season the last formed nearly erect leaves produce more and more stomata above and fewer and fewer beneath. Borodine shows also that this tendency to produce a considerable number of leaves destitute of stomata on their upper surface undergoes certain variations.

Sagenopteris and Hydropterangium.†—T. G. Halle writes on the Swedish species of *Sagenopteris* Presl and on *Hydropterangium*, a new genus. He thinks it probable that the *Marsilia*-like fossil leaves called *Sagenopteris* belong to the Hydropterideae, though their stomata occur on the upper surface only. This position of the stomata prevented Schimper from placing *Sagenopteris* in Hydropterideae. Halle also describes under *Hydropterangium marsilioides* some sporocarp-like bodies which are frequently found with *Sagenopteris*, and suggests that they may be closely related to one another. No spores were found, but the structure of *Hydropterangium* recalls *Marsilia*. Halle figures a series of leaves of *S. undulata* and *S. Nilssoniana*, in order to show the great variation that they present under each species.

K. Yasui ‡ describes the life-history of *Salvinia natans*, treating first of the microspore-formation and of the male prothallium, and then of the megaspore-formation, the female prothallium, fertilization, and embryo. The text is in Japanese. Some 93 highly magnified figures of the development of the various parts are given on the two folding plates.

Cones of *Selaginella*.§—M. G. Sykes and W. Stiles describe four main types of sporophyll in *Selaginella*. 1. In *S. pumila*, *S. rupestris*, and other species, the sporophyll has a well developed dorsal flap extending freely downwards and protecting the young sporangium immediately below it. Two of the species have radially arranged leaves and are presumably among the more primitive members of the genus. 2. In *S. spinosa*, the only other radial species examined, there is nothing which can certainly be compared with this free dorsal flap. A slight dorsal swelling is present, occupied by an air-cavity; it is possible that this may represent the reduced remains of such a flap. In this species the sporophyll is flat and the sporangium exposed. 3. In *S. helvetica*, one of the dorsiventral species, there is a well-developed dorsal projection, which is, however, not free but decurrent. It is especially prominent

* Ann. Jard. Bot. Buitenzorg, 3e Suppl. (1910) pp. 447-52.

† K. Svensk. Vet. Akad. Handl., xlv. No. 7 (1910) 16 pp. (3 pls.). See also Bot. Zeit., lxviii. (1910) pp. 165-6.

‡ Tokyo Bot. Mag., xxiv. (1910) pp. 81-91, 123-37.

§ Ann. Bot., xxiv. (1910) pp. 523-36 (pl.).

in the young cone where the two alternating sporangia of the whorl below are appressed against it. It is suggested that it may be homologized with the free dorsal flap in *S. pumila*, here fused with the stem. 4. The species of this type form a series, in which the dorsal outgrowth, which originally served to protect the sporangia below, is gradually reduced and lost, while at the same time each sporophyll more and more completely enfolds and protects its own subtending sporangium. In *S. flabellata* there is a transversely elongated dorsal projection, the median portion of which extends freely downwards; in *S. caulescens* the free median portion is lost, and only a small curved ridge is left; in *S. Vogelii* and *S. apus* all signs of a dorsal projection at the base of the sporophyll are lost. Finally, there appear to be in *Selaginella* a series of forms of sporophyll, the most complex being found in one of the more primitive species. This complex form presents a remarkable resemblance to the form of the sporophyll in *Lycopodium alpinum* and *L. cernuum*, and in *Spencerites*—a significant resemblance, though not meaning close relationship. The development of a complex sporophyll differentiated into dorsal and ventral portions, in genera separated in time and in general features so widely as are these three, seems to indicate that it is a very ancient character. Otherwise it is an instance of parallel development.

Rhizophore of Selaginella.*—W. C. Worsdell writes on the morphology of the rhizophore of *Selaginella*, discusses the views that have been put forward about its morphological value, and describes his own observations and experiments. He became convinced that the rhizophore is of a shoot-nature, and that the very definite place of origin of the rhizophores is a strong indication of their shoot-nature.

Periderm-formation in Filicinean Petioles.†—H. S. Holden announces in a note that, having discovered a typical wound-periderm in a Medullosean petiole, an account of which is about to be published, he has been led to investigate a number of Filicinean petioles, mostly of the Polypodiaceæ, with a view to determining whether a similar response is exhibited by them. As a result, he finds that quite a number of them show a well-marked wound-cambium, often several cells in depth.

Note on a Wounded Myeloxylon.‡—H. S. Holden gives an account of the wound-tissue visible in a thin section of a fossil plant, a *Myeloxylon* slide in Manchester Museum. Two to seven rows of periderm-cells, that have arisen from a group of cambium-cells, are shown in some photomicrographs.

Peculiar Fern Prothallia.§—L. Pace describes some peculiar fern prothallia, which, obtained on rotten wood from a swamp in Indiana, have been in cultivation ever since. The summary of her observations is that prothallia kept for three years in the laboratory in as nearly normal conditions as possible, except for the absence of liquid water,

* New Phytologist, ix. (1910) pp. 242-53 (figs.).

† Ann. Bot., xxiv. (1910) p. 611.

‡ New Phytologist, ix. (1910) pp. 253-57 (figs.).

§ Bot. Gaz., 1. (1910) pp. 49-58 (figs.).

continue to grow, but develop peculiar forms and branching of various types. The sex-organs continue to develop, antheridia being found occasionally on the main plant in all positions, but especially on the branches. Archegonia become very numerous, approximately 300 having been found on one gametophyte. These not only develop in the apical region, but also far back among the old archegonia. Fertilization may take place whenever liquid water is present, as shown in several cases where gametophytes were placed in water and sectioned later. Apogamy is present in a sporangium-like structure which lacked the long stalk of the Polypodiaceae, but was not unlike the younger stages of the sporangium of the Osmundaceae. It had two layers of cells outside the fertile region, the inner of these layers resembling a tapetum.

Culture of Fern Prothallia.*—E. D. Wuist obtained good results by cultivation in porous pots in bright light, the transpiration being carefully regulated. Most of the prothallia were dioecious; but archegoniiferous prothallia were made monœcious by placing them in a nutritive solution for 4 to 7 days. As to spores, they germinated readily in water in bright light (but less readily in nutritive solutions), and, when later transferred to nutritive solutions, they produced normal dioecious prothallia. Young sporophytes produced continued to grow in the nutritive solutions.

Geography of Ferns.†—H. Christ publishes a detailed book on the geographical distribution of Ferns, dividing the subject into two parts. 1. Ferns under the influence of soil and climate. In this part he treats of soils, climatic conditions of all sorts, hygrophytes and xerophytes, with their various modifications, arctic and alpine ferns, etc. 2. Fern floras. In this part he treats of the principles of floristic botany, such as distribution in its various aspects: endemism, cosmopolitanism, invasions, survivals, etc; the main floral regions—north temperate, Mediterranean, Chinese-Japanese, Malayan, Australasian, tropical African, South African and African Islands, Mexican, tropical American, South Brazilian, Andes, South Chile. A bibliography is provided.

Olaf Swartz's Types of Ferns.‡—C. Christensen gives an account of some ferns of Olaf Swartz's herbarium, now intercalated in the general herbarium of the Riksmuseum in Stockholm. He enumerates twenty-three of Swartz's types, adding critical comments. In a second list he gives seven Swartzian species which are included in the ordinary handbooks; the types of these are shown in photographs. In a third list he gives eight of Cavanilles's species, which were described in 1802-3, and which it is possible to recognize, thanks to authentic fragments found in Swartz's herbarium.

Relationships of the Genera of the Vittarieæ.§—R. C. Benedict discusses the relationships of the genera of the Vittarieæ. This tribe of ferns seems to furnish a good illustration of the law of recapitulation,

* Mich. Acad. Sci., 11th Rep. (1909) p. 37.

† Die Geographie der Farne. Jena: Fischer (1910) 358 pp. (129 figs. and 3 maps).

‡ Arkiv Bot., ix. No. 11 (1910) 46 pp. (5 pls. and figs.).

§ Journ. New York Bot. Gard., xi. (1910) pp. 101-2.

which is of such value to conchologists. *Vittaria lineata* forms beard-like clumps on palmettos in Florida, and its long narrow leaves have a simple venation; there is a single median costa, which gives off lateral veins at intervals. These lateral veins run to the margin, then bend forward parallel to the costa, and each joins up with the vein above it; thus a single series of areolæ is formed along each side of the costa. But the first-formed leaves of *V. lineata* are still more simple, and have but a single vein or costa. This is exactly the type of venation of *Monogramme trichoidea*, a Philippine species. The later leaves of *Vittaria lineata* show successively one or two to several areolæ. This stage corresponds to what is found in *Antrophyum minimum* Baker, which may belong to the genus *Hecistopteris* J. Smith. Similarly, *Antrophyum* and *Ananthacorus*, which have the most complex venation in the tribe, recapitulate the characters of *Monogramme* and *Hecistopteris*. They have several rows of areolæ on each side of the costa. The law of recapitulation may serve to elucidate the relationships of *Phlebodium*, *Goniophlebium*, and others which have a complicated reticulate venation.

Hymenophyllum peltatum in Yorkshire.*—W. E. L. Wattam records the discovery of *Hymenophyllum peltatum* Desv. (*H. Wilsoni* Hook.), the deflexed filmy fern, at Ingleton, and adds some remarks on its distribution by F. Arnold Lees. It has been recorded from Ingleborough and Dentdale.

Asplenium Lingelsheimi, a new hybrid.†—W. Seymann publishes some notes on a hybrid fern, *Asplenium Adiantum nigrum* × *Ruta muraria*, found on walls on Monte Igneldo, near San Sebastian. He gives its history in literature, and gives it the name *Asplenium Lingelsheimi*, with two forms—*adiantoides* and *rutoides*.

Two Species of *Platycerium*.‡—H. Christ gives an account and figures of two species of *Platycerium*. One was described by him in 1900 in Warburg's Monsunia as *P. sumbawense*, and occurs in the islands of Sumbawa and Timor. The other, *P. Ridleyi*, is a new species carefully described by him, and was collected by H. N. Ridley at Bukit Timah, Singapore, and is said to occur in Borneo and Lingga Island. Christ cites the collector's notes and discusses a question of nomenclature. The new species is allied to *P. coronarium*, but is smaller and has a remarkable hollow involute cucullate fertile frond, which protects the sorus from drought and rain. The plant grows in inaccessible positions on high trees.

Varieties of *Polypodium vulgare*.§—H. Kingsmill Moore gives an account of some varieties of *Polypodium vulgare* and of the mode of cultivation which he has found to be best suited to them. Having studied the plants in their natural habitats he attempted to cultivate them. The var. *ca.nbricum* and others succeeded well in exposed situations, but var. *cornubiense* would barely exist there. When, however, an attempt was

* Naturalist, No. 640 (1910) p. 214.

† Oesterr. Bot. Zeitschr., lx. (1910) pp. 278-80 (figs.).

‡ Ann. Jard. Bot. Buitenzorg, 3^r Suppl. (1910) pp. 7-12 (2 pls.).

§ Journ. Roy. Hort. Soc., xxxvi. (1910) pp. 112-14 (4 photos.).

finally made to grow the latter in leaf-mould, mixed with lime, rubble and sand, in the hollow of sheltered rotten tree-stumps, the plants succeeded beyond all expectation. Thus var. *cornubiense* and its crested form *multifido-elegantisimum*, also var. *ramosum* and var. *pulcherrimum*, are now a great success.

New European Fern.*—Frère Sennen gives an account of a fern, collected at the foot of the Cantabrian mountains, near Santander in the north of Spain, which is new to the European flora. Originally distributed as *Polypodium Eliasii* Sen. & Pau., it is shown by H. Christ to be in fact *Dryopteris africana* (Desv.) C. Chr., formerly known as *Gymnogramme Totta* Schlecht., a species with a distribution extending from West Africa to Japan, long known in Madeira and even in the Azores, and a member of the group of Atlantic ferns—*Davallia canariensis*, *Asplenium hemionitis*, *Woodwardia radicans*. It belongs to the *Leptogramme* section of *Dryopteris*. Frère Elias found it in a sheltered spot in a wood near the sea.

New North American Ferns.†—L. S. Hopkins publishes descriptions and figures of two new varieties of common North American ferns. One of them is *Adiantum pedatum* var. *laciniatum*, in which some of the normal pinnules are replaced by linear branching pinnules which are partly fertile and partly sterile at their tips. And the other is *Cystopteris fragilis* var. *cristata*, in which the apices of the frond and pinnæ are forked, and acute or obtuse.

North American Ferns.‡—R. Dodge recently delivered an address to the American Fern Society on the subject of Variation in *Botrychium ramosum* (better known as *B. matricariifolium*). By keeping the plants under observation in their natural habitats, by noting the effect of drought and winter, of soil, of prevailing winds, etc., he is led to the conclusion that *B. ramosum* is a polymorphic species, of which *B. tenebrosum*, *B. simplex*, and *B. lanceolatum* are but forms, due to chemical and biological laws not yet understood.

W. N. Clute § gives a simple account of the Philippine *Doryopteris ludens* for comparison with the American *D. pedata*, figured by him two years previously. He also || describes and figures three forms of *Polypodium vulgare*. And he offers some suggestions as to the employment of regularized descriptive names for garden forms, e.g. *furcatum*, *digitatum*, *polydactylum*, etc., for apical crestring; *ramosum*, *ramulosissimum*, etc., for lateral crestring. Under the head of Pteridographia, ¶ he has put together notes on forms of *Lycopodium clavatum*, fertile spikes in *Botrychium*, an aberrant *Osmunda*, stolons of *Nephrolepis*, forms of *Botrychium obliquum*.

A. Prescott ** gives an account of some juvenile ferns, the identification of which has perplexed her.

* Bull. Acad. Internat. Géogr. Bot., xix. (1910) pp. 95-6.

† Ohio Nat., x. (1910) pp. 179-81.

‡ Fern Bulletin, xviii. (1910) pp. 33-43.

§ Tom. cit., pp. 47-51.

¶ Tom. cit., pp. 43-5 (pl.).

** Tom. cit., pp. 51-5.

** Tom. cit., pp. 45-7.

American Forms of *Lycopodium complanatum*.*—C. A. Weatherby discusses the American forms of *Lycopodium complanatum*. The species occurs in the Western Hemisphere in two distinct areas. One area extends from North Carolina to Alaska; the other from South Mexico to Bolivia and South Brazil. There are two northern and two southern varieties; but there is nothing to warrant specific segregation. Weatherby gives a synopsis of the varieties, and arranges them as follows: the type (North America, Alaska to Maine, Europe, Asia); var. *validum* (Mexico) a new variety; var. *tropicum* (South America) syn. *L. thyooides* Humb. et Bonpl.; var. *stabilitiforme* (Nova Scotia to North Carolina); var. *Wibbei* (New England).

New Tropical Ferns.†—E. Rosenstock publishes diagnoses of some new species of ferns, two from Kaiser Wilhelms Land, in New Guinea, collected by G. Bamler; two from East Java, collected by Mousset; and three from South Brazil, collected by Schmalz and by Wacket.

Ferns of Argentina.‡—C. M. Hicken publishes descriptions of some new Argentine ferns, representing two species and two varieties.

Ferns of Venezuela.§—J. R. Johnston gives a list, revised by W. R. Maxon, of the Pteridophytes of the Venezuelan island of Margarita. It comprises fifty-five ferns and two species of *Lycopodium*, with the synonymy and geographical distribution appended.

Ferns of South China.—H. Christ || publishes a fourth list of ferns collected in Kouy-Tchéou, by J. Cavalerie, partly from the environs of Pin-fa (including *Pteris insignis*, *Trichomanes Fargesii*, and two novelties, *Cyrtomium Hemionitis* and *Plagiogyria argutissima*) and partly from the new station Lofou, a set of tropical, Malay character, comprising twenty-eight species. Eight new diagnoses and a figure of *Cyrtomium Hemionitis* are given.

He also ¶ gives descriptions of four new ferns collected by Bon in Tonkin, and defines Subconjunctæ, a new subsection of the *Nephrodium* section of *Dryopteris*, illustrating the venation with a figure.

Bryophyta.

(By A. GEPP.)

Sexuality in the Mosses.**—J. Cardot gives a resumé of the later studies of El. and Em. Marchal on sexuality in the mosses. In their previous publication they had shown that in the case of dioicous mosses regeneration of the sporophyte produces sexiferous plants which present, at least virtually, a hermaphrodite character, and which are capable of

* Proc. Amer. Acad., xlv. (1910) pp. 412-15.

† Fedde's Repertorium, viii. (1910) pp. 163-4, 277-9.

‡ Trab. Mus. Farmac. Buenos Aires, No. 19 (1907). See also Fedde's Repertorium, viii. (1910) pp. 275-6.

§ Proc. Boston Soc. Nat. Hist., xxxiv. (1909) pp. 177-86.

|| Bull. Acad. Internat. Géogr. Bot., xix. (1910) pp. 137-43.

¶ Not. Systemat. Herb. Mus. Paris, i. (1910) pp. 185-8 (fig.).

** Rev. Bryolog., xxxvii. (1910) pp. 87-9.

multiplying themselves indefinitely by asexual methods. The question remained, whether the gametes of this hermaphrodite form, obtained from a strictly dioicous species, could form an egg and therefrom a tetrahaploid sporogonium. But the Marchals, in testing this question, found that their cultures of diploidic gonophytes, though kept under observation for two years, remained completely sterile; and yet an histological study of the sexual organs revealed no abnormality, save that the antherozoids are rarely mobile. The Marchals accordingly concluded that in the case of dioicous mosses the aposporic gonophytes are cursed with an absolute sterility; but that they can transmit their bisexuality to new individuals by vegetative propagation. This conclusion Cardot regards as rather premature and as too absolute; for he holds that in certain unknown unexpected and unusual conditions the aposporic gonophytes might conceivably be provoked into a state of fertility; and that a diploidic aposporic race after a prolonged period of sterility might become for a brief time fertile. Perhaps it would be wise to continue the cultures for a long period of years. The Marchals have also studied the behaviour of monoicous species (*Amblystegium serpens*, *A. subtile*, *Barbula muralis*). The aposporic gonophytes obtained from them have the same sexuality as normal gonophytes; but the remarkable thing is that diploidic state in no way hinders their fecundation. The resulting sporophytes, when examined cytologically, were found to be tetraploidic, the chromosomes showing themselves during the phases of sporogenesis to be twice as many as in normal sporophytes and the chromatic elements united in pairs. From the tetraploidic capsule are produced diploidic spores, which are fertile and which fix definitely the new race, the bivalent race. Finally, by regeneration from the tetraploidic sporophytes, some tetraploidic gonophytes have been obtained, constituting a tetravalent race, but have not yet been found to be fertile, the lapse of time being insufficient. An interesting fact which results from the Marchals' cytological observations is that the size of the cells and of the nuclei is distinctly larger in diploidic gonophytes than in normal gonophytes, and is larger still in tetraploidic gonophytes. There is in fact a direct proportion between the number of the chromosomes and the size of the nucleus and cell. And correspondingly the reproductive organs themselves are of larger size. Consequently it is possible to find in the size of the cells and nuclei (of, for example, the perigonal bracts, antheridia, spore-mother-cells, etc.) a criterion for the discrimination between normal plants and the products of apospory. And in conclusion, some simple experiments made by the Marchals show that young sporogonia, when wounded, readily give rise to an aposporic protonema. Hence it behoves bryologists to bear in mind the possibility of apospory when studying the variability of mosses and the relations of allied species.

Discoid Gemmæ in Foliose Hepatics.*—N. E. Stevens gives an account of the discoid gemmæ in the leafy hepatics of New England. In the leafy hepatics there are two distinct types of gemmæ. 1. Those of the simpler type are unicellular or bicellular, and arise in clusters on leaf or stem near the apex. 2. Those of the second type are discoid multicellular bodies, borne either on margin or surface of leaf. Gemmæ-

* Bull. Torrey Bot. Club, xxxvii. (1910) pp. 365-73 (figs.).

formation of the simpler type seems often to be associated with limitation of growth, the entire growing-point being given over to the production of gemmæ. The production of discoid gemmæ, on the other hand, rarely seems to affect the growth of the plant much. Gemmæ of the simple type are much common on northern forms, whereas discoid gemmæ occur chiefly on tropical epiphyllous species. In New England two species bear discoid papillæ, namely, *Cololejeunea Büdlercomizæ* and *Raulula complanata*, and it is the development and structure of the gemmæ in these that is discussed by Stevens.

Protonema and Propagules in Hepaticæ.*—I. Douin treats of the protonema and propagules of the hepaticæ. A 2-celled propagule of *Leioscyphus anomalus* gives rise to a prothallus of four cells, then to a rudimentary thallus, the two together constituting the protonema of the species. A rude stem with rudimentary leaves then arises, and, finally, a normal stem, leaves, and small amphigastria. A similar course of events is seen in the case of the germinating spores of *Cephaloziella striatula*. Thus in their development is found a link between the foliose and the thalloid Jungermanniaceæ, just as there is a link in their mode of fructification. Moreover, the importance of the propagules is seen in the fact that they transmit the same qualities as the spores, giving rise to the same course of development, and, though much neglected, they have a systematic value, if wisely used. They are produced with special precautions by the plant. For example, to protect them, amphigastria are developed in several species of *Cephaloziella* and *Cephalozia*, in which ordinarily no amphigastria are found. The propagules, in case of dioicous plants, carry on the sex of the parent plant, just as the spores do—at least, they behave just as true cuttings would. Thus *Cephaloziella dentata* is sterile in Eure-et-Loire, and reproduces itself entirely by propagules; the plants, indeed, produce archegonia annually, but never have them fertilized, owing to the absence of the male element. Propagula do not vary much. They are multicellular and lenticular in *Marchantia*, *Lunularia*, *Blasia*, and *Raulula*. But more commonly they are 2-celled and elliptic or angulate, as in *Cephalozia*, *Lophozia*, *Marsipella*, *Aneura*. They are unicellular in *Calypogeia*. And in *Gongylanthus* they were once seen to be in tetrads.

Rhizoids of Marchantiales.†—V. Schiffner discusses the rhizoids of Marchantiales. These are of two kinds: (1) the smooth-walled; (2) those with internal papillæ (Zäpfchenrhizoide). The latter are peculiar to the Marchantiales and do not occur at all in the Jungermanniales and Anthocerotales. Their meaning has been variously explained, but not in a manner to satisfy Schiffner. Botanists of the present day are, he says, too ready to invent biological meanings for every plant structure. He gives a résumé of the suggestions made by Strasburger, Leitgeb, Kny, Haberlandt, Stephani, Kamerling, Goebel. Schiffner himself, after examining a vast number of specimens, has come to the conclusion that the papillate rhizoids do at times conduct water as a part of their functions, and that the papillæ do prevent the

* Rev. Bryolog., xxxvii. (1910) pp. 73-7 (figs.).

† Ann. Jard. Bot. Buitenzorg, 3^e Supp. (1910) pp. 473-92 (figs.).

channel of the rhizoid from being blocked by bubbles. But these are not the only functions of the papillate rhizoids; for they occur just as freely and as well developed in plants which are so bathed in water that no bubbles could possibly be formed. He thinks it far more likely that the presence of papillate rhizoids in the Marchantiales and their total absence from all other hepatics is just a distinctive morphological character of the group, and that they have not been adapted from the smooth-walled rhizoids to meet a special requirement. They are morphological, not biological. Strangely enough there are two kinds of rhizoid in one genus of the Jungermanniales, namely the thalloid *Monoclea*. They are smooth-walled. But there is no reason to suppose that the narrow sort have in any way developed from the papillate rhizoids of the Marchantiales. Nor is there any close phylogenetic relationship between *Monoclea* and Marchantiales.

Luminosity of Moss Leaves.*—A. J. M. Garjeanne discusses the phenomenon of the reflection of light by moss leaves, especially the peculiar golden-green gleam which is seen sometimes in the leaves of *Mnium*, etc. He describes what he himself observed in the stolons of *Mnium rostratum* growing in a dark, narrow ditch near Venlo, in Holland. A close examination showed him that the back of each leaf was covered by a clinging drop of water, which formed a biconvex or plano-convex lens. Further consideration has led him to the conclusion that the peculiar luminosity is due to the double reflection undergone by the incident rays of light within this aqueous lens on the back of the leaf. It is mostly the younger leaves of the stolons which behave in this way.

Types of Tropical Mosses.†—K. Giesenhagen gives an account of the principal types of moss-life in tropical forests of the rain-zone, and the way they adapt themselves to their environment. He describes the external factors that affect the plants, the most important being the saturated condition of the atmosphere. He thus discusses the types of moss-associations. 1. Orthotropic, including humble tufts, tall tufts, and moss cushions. 2. Plagiotropic, including mats and lax tangles. He also divides the solitary mosses biologically into (1) terrestrial, including simple erect stems with distant leaves, and simple erect stems with a crown of leaves at the top; (2) epiphytic, including frond-like and pendulous. He gives examples of each type, and discusses them in some detail. Finally, he gives a list of 105 mosses and 74 hepatics collected by him in Sumatra, Java, and Ceylon.

Inter-relationships of Bryophyta.‡ — F. Cavers continues his account of the inter-relationships of the Bryophyta. First he treats of the two views that may be taken, either that the Marchantiales form an ascending group, starting from *Riccia* and culminating in *Marchantia*; or that they show wholesale reduction, starting from a type like *Marchantia* and having in *Riccia* the most reduced member of a descending series.

* Beih. Bot. Centralbl., xxvi. 1^{te} Abt., (1910) pp. 1-6 (pls. and figs.).

† Ann. Bot. Jard. Buitenzorg, 3^e Supp. (1910) pp. 711-90 (2 pls. and figs.).

‡ New Phytologist, ix. (1910) pp. 193-234 (figs.).

The latter view gains considerable support from Goebel's recent study of *Monoselenium*. He then passes on to his third chapter—Anacrogynous Jungermanniales, a group which he divides into four families—Aneuraceæ, Blyttiaceæ, Codoniaceæ, Calobryaceæ. He then discusses their inter-relationships, summing them up in a pedigree table, where he shows two main branches. The *Aneura* line leads up to *Symphogyna*, etc., and the *Pellia* line leads up to *Fossombronia* and the acrogynous hepatics.

Primitive Form of the Liverworts.*—J. P. Lotsy replies to a criticism of a passage in his *Vorträge über botanische Stammesgeschichte*, and briefly explains how he tried to determine what was the primitive form of the liverworts. The question was this: Which hepatic shows the greatest similarity to the Algæ? *Anthoceros* was ruled out because of its highly-developed $2x$ -generation. *Riccia*, also, which has a lowly $2x$ -generation, was ruled out on account of the high development of its x -generation. *Sphærocarpus* is the most simple surviving hepatic, but its $2x$ -generation is too highly developed—is higher than that of *Riccia*. The primitive hepatic must have had a very simple thallus and sporophyte, recalling *Sphærocarpus* and *Riccia* respectively. Accordingly he gave to this hypothetical form the name *Sphæroriccia*.

Acolea and Marsupella.†—C. Massalongo has published a monograph of the Italian species of *Acolea* and *Marsupella*. The former genus is characterized by the want of a perianth, and the latter genus by the presence of a perianth. As regards vegetative characters, each of the genera has two analogous groups of forms; and if the perianth-character were disregarded the two genera could be united. But Massalongo prefers to keep them distinct. For *Acolea* he minutely describes six Italian species, and for *Marsupella* eleven, supplying keys for their easier determination, and appending full synonymy and distribution.

Chiloscyphus and Heteroscyphus.‡—V. Schiffner discusses *Chiloscyphus* and the new genus *Heteroscyphus*. The old *Chiloscyphus* is a heterogeneous group, uniform in the character of its fertile branch and perianth, but very diverse in habit and in the character of the androecium. There are two types of androecium. 1. In *Chiloscyphus* proper, containing all the European species, the androecia are intercalary on the main stem or on the equal side branches, the bracts being like the sterile leaves. 2. In *Heteroscyphus* the androecia are small, amentiferous, and apparently ventral, and the bracts are small and unlike the stem-leaves. The species of *Heteroscyphus* are almost all exotic. Schiffner defines these two genera, and enumerates the species referable to each, and gives a list of over twenty species the androecia of which are unknown. It may be that a third genus will have to be set up.

Bryological Notes.§—V. Schiffner publishes another instalment of his bryological fragments. 58. The unknown *Jungermannia flaccida* of Hübener is, on the evidence of the original specimen from the Harz

* Bot. Gaz., xlix. (1910) pp. 460–1.

† Atti R. Ist. Veneto, lxxix. (1909) pp. 109–50 (figs.).

‡ Oesterr. Bot. Zeitschr., lx. (1910) pp. 169–73.

§ Tom. cit. pp. 271–5.

mountains, not a proper species, but is a flaccid form of *Nardia obovata* var. *rivularis* Schiffn. 59. K. Müller's recently published species *Marsupella ramosa*, from Allgäu in Bavaria. Schiffner has studied several specimens of this, and gives the results of his examination, being entirely in accord with K. Müller, except as to its affinities. Schiffner holds that it is very closely related, not to *M. emarginata* and *M. Funckii*, but to *M. Sullivantii* in structure of stem, leaves, and other details. 60. He records two hepatics new to Sardinia: *Riccia Bischoffii* var. *ciliifera* Lindenb. and *R. Gougetiana* Mont. 61. *Raphidostegium Welwitschii* is recorded from the Dalmatian island of Arbe, where the fruiting plants occur on damp sand among heather. It is an Atlantic moss, which is spreading eastwards along the Mediterranean.

Ephemeropsis tjibodensis.*—A. Ernst gives an account of *Ephemeropsis tjibodensis* Goeb., an extraordinary little epiphytic moss recorded from a mountain in Java. He finds that it is by no means rare, but that it abounds in mountain-woods under favourable conditions, and is widely distributed. He found it on Mt. Salak in Java, in Sumatra and in the Malay Peninsula. He never found it in fruit, but he found plants with gemmæ in every stage. He describes the development of these gemmæ, and discusses the distribution of the genus. The species grows epiphytically on all sorts of plants, even on mosses and lichens, but prefers rough leaves.

Cynodontium Jenneri.†—H. N. Dixon discusses the question, What is the true name of *Cynodontium laxirete* Grebe? The moss was described in 1868 as *Didymodon Jenneri* by Schimper in an article by C. Howie, and shortly afterwards was referred to *Dicranum polycarpum* by Wilson. It is now usually regarded as a proper species, and has been redescribed as *Cynodontium laxirete* by Grebe and as *Oncophorus polycarpoides* by Stirton. More recently Stirton has proposed for it the new combination *Cynodontium Jenneri*, which no doubt is its lawful name.

Ceratodon conicus.‡—W. G. Travis publishes a note on the occurrence of *Ceratodon conicus* in the Mersey district. He collected the moss on the sandhills at Formby and at Freshfield, where it grows associated with *Bryum pendulum*, *B. Warneum*, etc., just as it does at Dunkirk on the French coast, where it is common in hollows of the dunes. It has also been found on sandhills at New Brighton, Cheshire.

What is Dicranoweisia robusta Vent.?§—A. Luisier discusses the identity of *Dicranoweisia robusta* Vent., a Portuguese moss, collected by E. Sequeira at Penafiel, and described by him under *Dicranodontium* in 1881, and by Venturi under *Dicranoweisia* in 1882. And since then it has remained an unknown species, at least outside Portugal. Recently Luisier found among some of I. Newton's specimens at the Polytechnic Academy at Oporto two specimens of *Glyphomitrium polyphyllum*, which also bear the name *Dicranoweisia robusta* Venturi, and which had been

* Ann. Bot. Jard. Buitenzorg, 3e Suppl. (1910) pp. 699-710 (pl.).

† Rev. Bryolog., xxxvii. (1910) pp. 72-3.

‡ Journ. Bot., xlviii. (1910) pp. 205-6.

§ Bull. Soc. Port. Sci. Nat., iii. (1910) pp. 60-3.

collected at the stations and at the dates recorded for this latter species. They correspond exactly with Venturi's description, which, however, is rather vague about the areolation. However, an examination of the type in Venturi's herbarium at Trient finally settled the question. *D. robusta* is henceforth but a synonym of *Glyphomitrium polyphyllum*.

Pohlia carnea in Transylvania.*—I. Györfy gives a detailed account of the morphology of *Pohlia carnea* Lindb. fil., treating of its stem, leaves, seta, sporogonium, etc., illustrating the same with figures. He finds that it differs in some points from previous descriptions.

"Neolithic" Moss Remains.†—H. N. Dixon gives an account of some "neolithic" moss remains from under the 25-foot raised beach near Fort William, washed out of sandy peat. Thirty-six species were identified, the fragments being mostly in a good state of preservation. This collection differs from all, or nearly all, previous collections in being distinctly not a paludal or a peat-moss association. Very few of the constituent species could be considered to be in any way paludal. A few are inhabitants of wet rocks. Others grow on dry boulders. Several belong to the woodlands. In all probability these plants originally were growing near a large stream which tumbled over boulders and flowed at times between wet, rocky cliffs down a wooded mountain side or valley. In such a situation in Scotland at the present time an almost precisely similar moss-association is found. The seeds found in the same deposit indicate a meadow origin, and are badly preserved. The climate of the period must have been mild and equable, as is indicated by the presence of *Dicranum Scottianum*. *Thuidium delicatulum* is interesting as a moss, which, until 1874, was regarded as common in North America and absent in Europe, but is now known to occur all over Europe, and in England is found to be western and montane. *T. Philiberti* is a rare moss, growing on wet mountain rocks; first found in 1893, it is now known from several places in Europe and North America.

Scottish Hepaticæ.‡—S. M. Macvicar publishes a list of additions for 1908-9 to the census of Scottish hepaticæ. There are 89 additional records distributed under 25 botanical counties. *Lophozia longidens* is a new record for west Scotland.

Moss-flora of Todmorden, Lancs.§—A. Stansfield gives an enumeration of the mosses found at Todmorden amounting to 194 species. Some—for instance, all five species of *Orthotrichum*, which were formerly met with in the district—have disappeared. The hepaticæ amount to 46.

New Lancashire Mosses.||—J. A. Wheldon calls attention to some new Lancashire cryptogams. *Sphagnum parvifolium* Warnst., from 900 ft. altitude near Rochdale, is a variety of *S. intermedium*. *Drepano-*

* Magyar Bot. Lapok., ix. (1910) pp. 120-6 (pl.).

† Ann. Scottish Nat. Hist., No. 74 (1910) pp. 103-11.

‡ Tom. cit., pp. 114-17.

§ Lancashire Nat., ii., pp. 204, 249-52, 285-88, 311-13, 347-50, 355-57.

|| Op. cit., iii. (1910) pp. 81-2.

cladus uluncus var. *Wheldoni*, from the Southport sand dunes, was recently described by Renauld, and differs in its markedly dimorphous leaves from var. *falcatus*. Another new form from the same place is *D. uluncus* var. *falcatus* f. *littoralis* Ren. It is the ordinary form of the sea-shore. A puzzling specimen from near St. Anne's has been referred by G. Roth to *D. uluncus* var. *pseudo-Sendtneri*.

Lancashire Hepatics.*—W. G. Travis announces that he was fortunate enough to rediscover the rare *Petalophyllum Ralfsii* among the sandhills at Freshfield. Years ago it used to occur near Birkdale, but the site is now built over. It is distinguished from all other British hepatics by the delicate dorsal lamellæ on its thallus.

He also † records the finding of *Lejeunea cavifolia* in Skillaw Clough, near Parbold, south Lancashire, where it was sparingly associated with *Metzgeria furcata* and *Neckera complanata* on Permian limestone.

Additions to the Manx Sphagna.‡—J. A. Wheldon records some additions to the Sphagnaceæ of the Isle of Man. The Census Catalogue of British Mosses gives a complete record of the Manx moss-flora up to 1907. Nine species and five varieties of *Sphagnum* are there recorded. But the island is really rich in these plants in its moorlands and bogs. And Wheldon now furnishes a list containing twenty-one species and nineteen varieties. It is expected that another ten or twelve species, such as occur in Lancashire and Westmorland, will be found upon further search.

Moss-flora of the Jura.§—C. Meylan gives a list of species gathered by him in the Jura during 1908–9, namely twenty-three mosses, four sphagna, nineteen hepatics. Eleven of them are new to the range. Special notes are added to *Brachythecium Geheebii* and to *Calypogeia*, the relationship of *C. Neesiana* to *C. Trichomanis* being discussed, and a key appended to facilitate the better discrimination of *C. suevica*, *C. Neesiana*, *C. Trichomanis*, and their varieties.

Moss-flora of the Haute-Saône.||—A. Coppey begins a series of phytogeographic studies on the mosses of the Haute-Saône. In the present instalment he makes an introductory statement and defines the object of his work; provides a bibliography extending from 1845 to 1909, and briefly criticises its contents; describes the general characters of the region, and explains the method adopted; and makes some general remarks on ecology. His work is based on the Catalogue raisonné of Renauld (1873 and 1883), with additions to and corrections of its determinations and its notes on distribution.

Spanish Bryophytes.¶—A. Casares Gil gives a list of ten hepatics and nine mosses which are new to the Spanish flora. Among them is a description of the new *Scapania Casaresana* Steph.

* Lancashire Nat., ii. (1909) p. 23.

† Tom. cit., p. 128.

‡ Op. cit., iii. (1910) pp. 7–10.

§ Rev. Bryolog., xxxvii. (1910) pp. 77–81 (figs.).

|| Tom. cit., pp. 81–7.

¶ Bol. R. Soc. Española Hist. Nat., x. (1910) pp. 242–4.

Rare European Mosses.*—T. Herzog publishes notes on some difficult and new species of European mosses. He discusses critically *Rhabdoweisia crenulata* (Mitt.) Jameson, and gives descriptions of *Cynodontium meridionale* and *Oncophorus sardous* from Sardinia, and *Pohlia Berninæ* and *Brachythecium Rubelii* from Switzerland.

European Hepatics.†—K. Müller publishes two more parts of his Lebermoose, and treats of *Jamesoniella*, 2 sp.; *Anastrophyllum*, 3 sp.; *Sphenolobus*, with two subgenera: (1) *Eusphenolobus*, 7 sp.; (2) *Tritomaria*, 4 sp.; and the large genus *Lophozia*, with three subgenera: (1) *Barbilophozia*, 11 sp.; (2) *Dilophozia*, 14 sp., unfinished; (3) *Leiocolea*. A pedigree table displays the species of *Lophozia* in one connected group placed according to their affinities. Keys, detailed descriptions, figures, critical notes, synonymy, and distribution are supplied.

North American Moss Book.‡—A. J. Grout has published the fifth and last part of his Mosses with Hand-lens and Microscope. Abundantly illustrated with original drawings, or more usually with figures from Sullivant's *Icones* or from the *Bryologia Europæa* of Bruch and Schimper, the book serves to make easy the study of the more common mosses of the north-eastern United States. It is written in non-technical English and provides keys to the genera and species. At the end of the book is a key to sterile specimens, which the author hopes may enable the student to recognize sterile mosses of special interest.

North American Bryophytes.—A. Lorenz§ gives an account of *Lophozia alpestris* Evans as it occurs in New England. Originally called *Jungermannia alpestris* by Schleicher, it is found in the mountains of Europe. The points in which it differs from its allies are narrated, and an extract from Nees's *Naturgeschichte* is given.

H. E. Greenwood|| gives an account of five common species of *Cephalozia* illustrated by photo-micrographs, which show the more common characteristics of each species. The examples figured are *C. bicuspadata*, *C. curvifolia*, *C. connivens*, *C. serriflora*, *C. lunulifolia*.

J. Röhl¶ treats of the typical form and the series of forms with reference to the genus *Sphagnum*, in reply to an article by Le Roy Andrews in the January number of the same periodical. Röhl maintains that in Sphagnology it is preferable to employ series of forms (Formenreihen) rather than types of species (Artenotypen).

J. M. Holzinger** notes some additions to the moss-flora of the United States, and gives a new description of *Grimmia Agassizii*.

E. G. Britton †† gives a short biographical notice of Adalbert Geheeb (1842–1909), whose moss-herbarium has been added to the Botanical Museum at Berlin.

Critical Mosses of New England.‡‡—G. E. Nichols publishes some notes on Connecticut mosses, by way of supplementing or amending

* Allgem. Bot. Zeitschr., xvi. (1910) pp. 81–5.

† Rabenhorst's Kryptogamen-Flora, vi. lief. 10–11 (Leipzig, 1910) pp. 577–704 (figs. 287–321). ‡ New York: 1910, pp. 319–416 (pls. and figs.).

§ Bryologist, xiii. (1910) pp. 69–71. || Tom. cit., pp. 72–6 (6 figs.).

¶ Tom. cit., pp. 77–9.

** Tom. cit., pp. 84–5.

†† Tom. cit., p. 86.

‡‡ Rhodora, xii. (1910) pp. 146–54.

Evans and Nichols's *The Bryophytes of Connecticut* (1908). Nichols has been studying the *Ephemeræ*, and gives his results. The species of *Nanomitrium* and *Ephemerum* are very minute, consisting of a short stem and a bud-like cluster of leaves, in which nestles the diminutive sporophyte, and they arise from a persistent green protonema. They are annuals, and mostly grow in open, moist places: for example, in dried-up ponds. *Nanomitrium* is distinguished from *Ephemerum* by possessing a well-marked rudimentary lid to its capsule. At maturity the capsule of *Nanomitrium* has a delicate unistratose wall, the spore-sac having disappeared. In *Ephemerum*, on the other hand, the capsule has no lid and its wall is bistratose, is comparatively tough, and contains stomata; also, the spores are twice as large ($80\ \mu$ as against $35\ \mu$ in *Nanomitrium*). *Nanomitrium* appears to be rarer than *Ephemerum*, but both genera escape notice owing to their small size. The species of *Ephemerum* are classified by their leaf-characters. In one group the leaves possess no midrib. In the other group a midrib is present, though often indistinct. This latter group is again divided into two, in one of which the leaves are ovate-lanceolate and smooth; in the other the leaves are narrowly lanceolate and distinctly papillose. Nichols gives further details, which need not be quoted here.

Passing on to the recent additions to the flora of Connecticut, the author gives notes on:—1. *Physcomitrium immersum*. This is frequently confused with *Aphanorrhagma serratum*, but differs in habit, growing in laxer tufts, and also in the supra-medial dehiscence of its thin-walled capsule. *Aphanorrhagma* grows in depressed tufts, and its capsule is tough-walled and dehisces round the middle. 2. *Aulacomnium androgynum* does not fruit in the eastern states, but produces masses of gemmæ. 3. *Philonotis marchica* and *P. cæspitosa*. These species had been overlooked, and have been brought to light as a consequence of Dismicr's revision of the European and North American species. A key for the discrimination of *P. marchica*, *P. cæspitosa*, and *P. fontana* is given. 4. *Pterigynandrum filiforme* and *Pogonatum brachyphyllum* have recently been found in small quantity. 5. *Drepanocladus aduncus* (*Hypnum aduncum* L.). There is much dispute about the identity of this plant. The following solution is suggested by Warnstorff. The *Hypnum aduncum* of Linnæus was misunderstood by Hedwig, who unwittingly redescribed Linnæus's plant as *H. uncinatum*, and wrongly applied the binomial *H. aduncum* to a collective group of forms of *Harpilium* (= *Drepanocladus*). From the latter group several species, viz. *H. Kneiffii*, *H. Sendtneri*, etc., have been split off by Schimper; and the disputed question remains, What is *Hypnum aduncum* Hedw.? Warnstorff follows Lindberg in discarding *H. uncinatum* Hedw. and retaining *H. aduncum* Linn. (= *Drepanocladus aduncus* Warnst.), and he designates as *Drepanocladus subaduncus* a form which Hedwig certainly included in his *Hypnum aduncum* group.

Canadian Mosses.*—N. C. Kindberg publishes a list of Canadian mosses containing 104 species and varieties collected by Macoun, Brinkman, and others. Thirty-four new species and several sub-species and varieties are described.

* *Ottawa Nat.*, xxiii. (1909-10) pp. 137-43, 180-91.

Mexican Mosses.*—J. Cardot publishes a sixth instalment of his preliminary diagnoses of Mexican mosses. He describes thirteen species and two varieties of *Brachythecium* and *Rhynchostegium*. The specimens cited were collected chiefly by Pringle.

Bryophytes of New Caledonia.†—I. Thériot publishes a list of mosses from Caledonia collected by M. Franc. The list contains diagnoses of one new genus, twenty-two new species, and nine new varieties. The new genus is *Franciella*, and is distinguished from *Spiridens* by the great length of the pedicel (4 cm.), the shortness of the operculum, and the tissue of the leaves. In another list he enumerates seven other species which are new records for the island. In a third list he gives F. Stephani's determinations of the hepatics collected at the same time—seventeen species.

Japanese Bryophytes.‡—S. Okamura describes *Isotachis Makinoi*, a new species of liverworts from Yaku-Shima. The text is in Japanese.

He also§ gives a list of thirty-six mosses from the province of Etchu, and among them the new species *Haplohymenium brachycladon* Okam.

Specific Types versus Formenreihen.¶—J. Röhl renews the discussion of specific types *versus* series of forms, replying to Le Roy Andrews. Röhl maintains that the proper way to do systematic work is to go afield and collect specimens extensively, to study all the forms and group them together in series of forms (Formenreihen). The system of describing as a specific type the first specimen found is artificial and unnatural, and leads to the ignoring of all intermediate and divergent forms because they do not fit in with the type. In the "Formenreihen" method, special attention is paid to all these intermediate forms, because the purpose is to connect the species together, not to separate them artificially. In Sphagnology we ought not to bind ourselves to a system, but to learn to understand the speech of nature.

Specific Names of Sphagnum.¶—J. Röhl gives a list of names of species of *Sphagnum*, which, in point of priority, are in accord with the rules of the International Botanical Congress at Vienna, 1905. And with them he gives their synonyms. The list contains sixteen of these prior names and their dates.

Congress Notes.**—J. Röhl gives a short account of the conclusions reached at the International Botanical Congress in Brussels, especially in regard to the nomenclature of mosses. 1. It was decided that the starting-point in nomenclature for the hepatics and *Sphagnum* should be Linnaeus's *Genera Plantarum* (1753), and for the mosses Hedwig's *Species Muscorum* (1801). 2. A committee was appointed to prepare a list of *Nomina conservanda*. 3. Since the Congress was concerned with generic names, and not with specific, it did not deal with his suggestions

* Rev. Bryolog., xxxvii. (1910) pp. 65-72.

† Bull. Acad. Internat. Géogr. Bot., xix. (1910) pp. 96-104.

‡ Tokyo Bot. Mag., xxiv. (1910) pp. (50) (51).

§ Tom. cit., pp. (197) (198).

¶ Allgem. Bot. Zeitschr., xvi. (1910) pp. 53-5.

¶ Tom. cit., pp. 70-1.

** Tom. cit., pp. 86-7.

regarding the nomenclature of *Sphagnum*. 4. It was decided that diagnoses must, from January 1908 onwards, be written in Latin, and, though short, must contain at least one distinguishing character. The Latin diagnosis may be followed by a more detailed description in one of the four languages—English, French, Italian, or German. 5. Some proposals which Röhl put forward as to establishing priority and hindering the changing of old names, were rejected by the Congress.

Moss Criticisms.*—G. Roth replies to some remarks in L. Loeske's recently published Moss-studies. Loeske charges Roth with having drawn upon Limpricht's Laubmoose for the descriptions in his Europäische Laubmoose. Roth defends himself. Loeske condemns Roth's treatment of *Drepanocladus* as retrograde, and the descriptions as very inferior to those of Warnstorf. Roth claims that his figures are better than any descriptions. And so on.

Hepatics and Contamination.†—J. Archer, in a brief note, calls attention to the manner in which hepatics contrive to gather up smut and dirt. Even where other Cryptogams near a large town were fairly clean, the hepatics were coated with dirt.

Thallophyta.

Algæ.

(By MRS. E. S. GEPP.)

Fixing of Algæ.‡—A. Bonnet describes a new method of fixing algæ by means of quinone. Filamentous algæ, or species with a delicate thallus—for instance, Siphonæ, Confervaceæ, Conjugatæ, minute Phæophyceæ, or Florideæ—can be well preserved by treating with freshly prepared quinone, in the proportion of 4 : 1000. The fixing acts equally well in fresh-water or in salt-water, but in the latter case the quinone solution becomes brown more rapidly than in fresh-water. An alga once fixed in this medium resists much better the dehydration necessary for the mounting in glycerin jelly, Canada balsam, or other media. Chlorophyll becomes greenish-brown, of a more or less intense shade according as to whether it is already charged with phycophein or phycoerythrin. The rest of the protoplasm dyes a light yellow, while the cellulose membranes remain uncoloured.

Leuvenia, a New Genus of Flagellates.§—N. L. Gardner describes and figures a new genus of Flagellates containing one species, *Leuvenia natans*. It was discovered on the surface of quiet, fresh-water in a shady ravine in California by Professor Osterhout, and, subsequently, in water highly charged with organic matter, at San Francisco. The motile stage, growth stage, and palmella stage are described. As regards the systematic position the author says:—The somewhat unusual combination of morphological features which this organism possesses, such as the inconstant

* Allgem. Bot. Zeitschr., xvi. (1910) pp. 123-4.

† Lancashire Nat., iii. (1910) p. 67.

‡ C.R. Soc. Biol. Paris, lxxviii. (1910) pp. 957-8.

§ Univ. California Publications (Bot.) iv. (1910) pp. 97-106 (pl.).

number of nuclei and chromatophores in growth and mature stages, the presence of contractile vacuoles in the anterior and in the posterior ends in the motile stage, the method of chromatophore division, and the absence of such organs as pyrenoids, gullet, and stigma, makes its systematic position rather difficult to determine.

Asexual Mode of Auxospore Formation.*—K. Yendo and K. Akatsuka describe the mode of auxospore formation of *Arachnoidiscus Ehrenbergii* Bail. The spores were formed asexually, each from a single frustule. In the essential points the process of formation accords satisfactorily with that already observed by Smith, Schütt, etc., for *Melosira*. As, however, the process has not hitherto been known in *Arachnoidiscus Ehrenbergii*, the authors give here an account of it.

Physiology of Diatoms.†—O. Richter, in a previous paper, showed that sodium was indispensable to *Nitzschia putrida* Benecke, a marine diatom, and in the present paper he shows that the same holds good for brown marine diatoms of the *Nitzschia* and *Navicula* type. As a proof of this he made use of a medium containing agar and 1 p.c. and 2 p.c. of salts of sodium, magnesium, and potassium. He considers that the membrane of marine diatoms contains sodium silicate.

Diatoms of the Sedbergh District.‡—R. H. Philip publishes a short study in the evolution of diatoms, founded on Peragallo's theory and illustrated by his examination of the species in the Sedbergh district. He shows first that diatoms are divided into three sub-families: the Raphidiæ, having a true raphe on at least one of the two valves; the Pseudo-Raphidiæ, having a blank space simulating a raphe on at least one valve; and the Crypto-Raphidiæ, which possess neither a true raphe nor the appearance of one on either valve. The first division (with some exceptions) are self-motile. The other two divisions are incapable of self-movement. He then goes on to show that diatoms may be regarded as being descended from a common ancestor with *Radiolaria*, an ancestor in which the differentiation of animal and vegetable had not been attained. In any case, however, the Diatomaceæ which are nearest to the *Radiolaria* are the earliest to appear in fossil deposits. These all belong to the Crypto-Raphidiæ, or as Peragallo prefers to call them, the Ana-Raphidiæ. As the life of diatoms devoid of power of motion was fraught with danger from the continual deposition of silt and other causes, it is evident that species which could develop a raphe and consequently a power of motion, would greatly benefit in the struggle for existence. Thus we find that the Raphidiæ are much the largest of the sub-families of to-day. Taking for instance the diatoms of the Hull district, of the 600 species recorded two-thirds are Raphidiæ and less than a sixth Ana-Raphidiæ. The author then goes on to show how great an advantage species of the Pseudo-Raphidiæ would have on the other hand in the ghylls and streams of gorges; and explains the acquisition of a stipes, like that of *Gomphonema*, and the advantages to be gained by the formation of chains, etc. He then details the species in the Sedbergh district,

* Bot. Mag. Tokyo, xxiv. (1910) p. 47-50 (pl.).

† SB. k. Akad. wiss. Wien., cxviii. (1909) pp. 1337-44.

‡ Naturalist, No. 639 (1910) pp. 148-52 (pl.).

which mostly belong to the Pseudo-Raphidiaceæ, and explains how this sub-family has become adapted to inhabit Alpine streams.

Bacillariaceæ from Nyassa Land.*—O. Müller publishes his fourth and last report on the collection of Bacillariaceæ obtained by the Nyassa-See and Kinga-Gebirg expedition. He treats of the Naviculinæ, Fragilarinæ and Eunotiinæ, comprising 25 genera and 265 species, etc., of which 38 are new. The total for Nyassa Land and the surrounding region is thus raised to 40 genera and 509 species, of which 125 are new.

Calcareous Phosphates composed of Diatoms.†—L. Cayeux describes an interesting investigation of a fragment of limestone brought from the banks of the Senegal river at Daoulalé by M. Chadeau. The formation is clearly Lower Eocene, hitherto unknown either in Senegal or throughout the centre of Africa. The fragment of limestone consists of phosphorus elements of irregular size and shape, and are of two sorts; one is composed of bone matter and the other of broken scraps of diatoms. Among the rare specimens which are whole and recognizable was seen *Triceratium* and *Coscinodiscus*. The result of this investigation is interesting to geologists, botanists and to the commercial world, inasmuch as the discovery of tripoli in Senegal may lead to its being found anywhere between that region and Tunis in sufficient quantity for practical use.

Characium.‡—F. D. Lambert describes two new species of *Characium*, *C. gracilipes* and *C. cylindricum*, which were found growing on *Branchiopus veruialis* in a small pool at Medford, Mass. They were both identified by F. S. Collins and distributed as Nos. 1269 and 1270 in the Phyc. Bor.-Amer. The author gives diagnoses and descriptions. He also adds a few remarks on *Dactylococcus Hookeri* and *D. de Baryanum*, which Collins regards as belonging to *Characium*. *C. gracilipes* and *C. cylindricum* are hosts of a fungus, of which the author figures two stages, promising further notes on the subject at a later date.

Coleochæte.§—F. D. Lambert describes and figures an unattached zoosporic form of *Coleochæte*, found in a small pond in Massachusetts, which he takes to be the dwarf zoosporic plants of *C. scutata* described by Pringsheim. The present observations confirm those of Pringsheim. These zoosporic plants form an independent phase in the life-history of the alga, but their existence has not always been recognized by authors, who have cast doubt on Pringsheim's statements. Details and figures of the development of this form are given in the present paper.

Dasycladus clavæformis.||—W. Figdor gives the result of his experiments on *Dasycladus clavæformis* as regards regeneration. He tried to force the plant to restore a lost vegetative growing-point, and was successful in nearly all cases. His attempts to bring about regeneration of the basal end of the plant failed in every case, and he found that in no plant were the rhizoids formed again after having been removed.

* Engler's Bot. Jahrb., xlv. (1910) pp. 69-122 (2 pls. and figs.).

† Comptes Rendus, cli. (1910) pp. 108-10.

‡ Tufts College Studies, iii. No. 1 (1910) pp. 1-11 (pl.).

§ Tom. cit., pp. 61-8 (pl.).

|| Ber. Deutsch. Bot. Gesell., xxviii. (1910) pp. 224-7.

E. Wulff * continues the work of Figdor by experiments with a view to testing the power of *D. claviformis* to transform (under the influence of external factors) the growing-point of the root into that of the shoot, and vice versâ. He was successful in changing a root growing-point into a shoot growing-point, but the opposite was a failure. The author regards light as the determining factor in this transformation; how far gravity and conditions of correlation take part in it is not determined.

Vaucheria. †—P. Desroche has proved by experiment that *Vaucheria terrestris* and *V. geminata* are, in reality, two forms of adaptation of one and the same species, capable of living aerially or aquatically. The one or the other of these forms is produced according to whether the plant grows in contact with the air or in a nutritive solution. The author's experiments were made on carefully isolated cultures of *V. terrestris*, which in a sterilized Knop solution of 2:1000 developed all the characters of *V. geminata*.

The same author ‡ in a later note describes a further transformation in the same culture. In one of his five tubes he noticed that sixteen out of his thirty-one examples showed the characteristic form of *V. geminata*; the others were all abnormal, the abnormalities being all of the same type. Each of the two symmetrical oogonia is replaced by a hermaphrodite group formed by an antheridium and two oogonia, and each of these oogonia may be replaced in its turn by a similar group. Thus there are formed cymes in which all the branches are terminated by antheridia, except the branches of the last generation, which bears oogonia. The most developed cyme observed showed branches of the third generation, and it seems as if the power of growth was unlimited. It appears also that the sex of a bud is not absolutely determined, and that even when a bud has begun a differentiation into an oogone, its differentiation may be arrested and replaced by vegetative growth; that then the female determinism of the bud disappears to give place to a sort of sexual indifference, represented by hermaphroditism.

Caulerpa prolifera. §—J. M. Janse continues his studies on this alga, and in the present paper gives the result of his experiments in deciding the influence which is exercised by basipetal impulsion on regenerating organs. In a former paper he dealt with the power of organs in *Caulerpa prolifera* to replace injuries with organs of a similar character, and the present work amplifies his previous conclusions. The first part treats of regeneration, with details as to the experiments, and the second with the actual change of organ caused by injury to young portions of the alga. Experiments on a young leaf-embryo showed that it might be entirely checked, or it might continue its growth as a leaf, or it might form either rhizoids or a rhizome. These possibilities are discussed at length, and then the two questions are propounded. 1. How comes it that the leaf-embryo so often changes its natural design

* Ber. Deutsch. Bot. Gesell., xxviii. (1910) pp. 264-68.

† C.R. Soc. Biol. Paris, lxviii. (1910) pp. 968-9.

‡ Tom. cit., pp. 998-1000.

§ Jahrb. wiss. Bot., xlviii. (1910) pp. 73-111 (2 pls.).

(Anlage)? 2. Why do not all leaves which are experimented upon behave alike? Finally, the author states that the likeness and difference between the different meristem plasmata cannot be explained; that they agree in all properties certainly, but that before the formation of the respective organs of the plant a difference takes place in them. Also that the meristem plasma of rhizome and rhizoid are more nearly related than is either of these with the meristem plasma of the leaf.

Periodicity in Dictyota at Naples.*—I. F. Lewis writes an interesting account of the periodicity in the production of the sexual cells of *Dictyota dichotoma* at Naples. Williams has described the same for Bangor and Plymouth, and Hoyt for Beaufort, North Carolina. The striking differences in the behaviour of the species in different localities makes every fresh observation on the subject of importance. At Naples the sexual cells of *Dictyota* were found to be produced at regular intervals, the time of initiation of the rudiments and liberation of the mature gametes bearing a definite relation to the periodic changes in the tides. The crops are borne, as at Bangor, at fortnightly intervals. Initiation of the rudiments occurs on the same day as general liberation of the mature gametes, this being two or three days after the least neap tide. The number of days required for the development of a single crop is approximately sixteen. The development of the sori is fairly uniform, not being accelerated at the time of the spring tides. Charts of comparison are given for the periodicity of plants at Bangor, Beaufort, and Naples. The causes of periodicity are discussed. The author finds that Williams' hypothesis, that the effective factor is the increased illumination during low water of spring tides, is inadequate to explain the phenomenon at Naples, since the *Dictyota* flourishes there at a depth of many feet below the surface, and the difference between the height of low water at spring and neap tides is only 0.25 foot. Nevertheless, he notes that the critical points in the sexual life of *Dictyota* coincide exactly with the periods of maximum intensity of illumination, both initiation and liberation occurring at Naples on the day that low water occurs at or nearest midday. The author believes that the stimulus of the maximum intensity of light is only one of the factors in producing periodicity, and that the factors may vary with the locality. Periodicity in the release of sexual cells is a widespread phenomenon, probably to be attributed to various factors in different species, and perhaps to more than one factor in the same species in different localities.

Himanthalia lorea.†—N. Wille has made a minute examination of the anatomical structure of *Himanthalia lorea*, and gives a detailed account of his results. The plant, as is well known, consists of a button-shaped vegetative portion, and of long strap-shaped outgrowths which bear the sexual organs. The vegetative part adheres to rocks at or near low-tide mark, and lives for two or three years. In the second or third summer of its life it produces the long strap-shaped thallus, which only survives for one summer. Since the two portions of the plant are so diverse in character, it follows that the anatomical structure is also

* Bot. Gaz., 1. (1910) pp. 59-64.

† Jahrb. wiss. Bot., xlvii. (1910) pp. 495-538 (2 pls.).

different, and the author in the present paper describes both in detail. In anatomical characters *H. lorea* shows, of course, marked agreement with other families of the Fucaeeæ, but it also recalls in some points the anatomy of the Laminariaceæ. Since the latter similarity is not to be explained by genetic relationship, it is probably caused by external conditions of life, and the more so since the habitat of *Himanthalia* and *Laminaria* is in general the same. The investigations here described were carried out on living material only, an essential condition in a study of either Fucaeeæ or Laminariaceæ.

Compsopogon.* — H. Murray records having found a quantity of *Compsopogon leptocladus* in the Reddish Canal, in Lancashire. Its distribution is purely tropical and sub-tropical, and it has never till now been recorded for Europe. Other aliens are also recorded for the Reddish Canal, but no explanation is given for their presence in Lancashire.

New Parasite on Gracilaria confervoides.† — H. L. Wilson has carefully examined certain tubercles or granules which are scattered profusely over the thallus of *Gracilaria confervoides* in San Francisco bay. They are colourless, and resemble sand grains or small particles of rice, being, in fact, from 1–2 mm. in any diameter. They are normally spherical in shape and smooth, and from their white colour are conspicuous against the dark thallus of the *Gracilaria*. Superficially the tubercles are alike, but in reality they are of three different kinds, each kind being devoted to the development of its particular organ of reproduction, tetrasporangia, antheridia, or cystocarps. There is no significance in the place they occupy on the *Gracilaria*, nor does their size offer any aid in determining their identity, for the smallest as well as the medium and the largest show well-developed organs of reproduction. The structure of each sort of tubercle is minutely described, and the following summary is given. The tubercle differs in tissue and structure from the *Gracilaria* on which it is found. It is provided with its own independent means of reproduction. It is furnished with numerous filamentous processes or rhizoids, that serve as a means of nourishment; and being thus amply endowed for the exigencies of its own existence, it must be classed as an independent plant. This plant, showing entire absence of colour, and provided with ample means of drawing its nourishment from another plant, must be classed with the parasites. Though this parasite is closely related to its host-plant, it cannot, on account of certain differences, be placed in the same genus; and therefore the author proposes the name of *Gracilariophila* for it, and calls it *G. oryzoides*. It has also been recorded on *Gracilaria multipartita*, and is found on the coasts of California.

Lithothamnium calcareum.‡ — P. Lemoine has made a study of this alga, and writes fully on its distribution and manner of life. It is extensively used on the coasts of Brittany for liming and improving the soil. The species is extremely variable in habit, and many forms of it

* Lancashire Nat., ii. (1909) p. 72.

† Univ. California Publications (Bot.) iv. (1910) pp. 75–84 (2 pls.).

‡ Annales de l'Institut Océanographique, i. fasc. 3 (1910) 30 pp. (1 pl.).

have been described. The author discusses first the distribution of *L. calcareum* in the region of Concarneau, Finisterre, where her investigation was carried out, and describes the forms found there. Then follows an account of the habit of life of the alga and the formation of "mäerl," the fertilizing material made from it. The plant may be found between 5 and 25 metres in depth, but mostly between 10 and 20 metres, and it seems to prefer a sheltered spot and a hard substratum. Of the many forms described the author recognizes as valid only six, including the type form f. *coralloides* Crouan. The forms are distinguished purely by their external aspect, for the anatomy of all is the same, and very few are ever found with reproductive organs. The anatomy, however, is very characteristic of the species, and quite distinguishes it from any other ramified species of *Lithothamnium*.

Irish Algæ.—J. Adams* publishes a list of synonyms of Irish algæ, in which the nomenclature of his previous paper, "A Synopsis of Irish Algæ," issued about two years ago, is brought up to date. The fresh-water species are given in a separate list from the marine species, and the former list has been revised by West. In the present paper 102 species have been added to the records in the previous paper, and a considerable number of new localities have been added to the species already recorded. A revised census of species is appended, and an additional bibliography which is complete to the end of 1909.

A. D. Cotton† gives a very brief account of a visit to Achill and Clare Island, where he found *Codium elongatum* and *Leathesia crispa*.

Algæ of Panama.‡—M. A. Howe gives a short report of his expedition to Panama last winter for the purpose of collecting marine algæ. There were, however, so very few algæ to be found that he had to direct his attention to other branches of collecting. A marine flora seems to be almost non-existent in the Bay of Panama, with the exception of certain encrusting algæ, some Cyanophyceæ, and species of *Euteromorpha*, *Chætomorpha*, *Bostrychia*, *Caloglossa*, *Catenella*, and some of the Rhodomelææ. At Colon more satisfactory results were obtained. The author is unable to account for the paucity of marine plant life in the region of Panama.

Algæ of Brandenburg.§—E. Lemmermann publishes the completion of his work on the Algæ of Brandenburg. This last part contains the Introduction, in which the author discourses on general subjects connected with his work: apparatus for collecting, manner of collecting, preparation of exsiccata, fixing solutions, reagents and staining, permanent mounts, cultures, drawing, and literature. The systematic part of the work contains the completion of the Flagellatæ, and the treatment of the Peridinales, both from the general and the systematic point of view. The author hopes that this book may form the ground-work of a thorough study of the Brandenburg Algæ and Protozoa, and to this end he has given drawings of many of the Flagellatæ and of most of the Peridiniææ.

* Proc. Roy. Irish Acad., xxviii. sect. B. (1910) pp. 167-214.

† Kew Bulletin, 1910, pp. 171-2.

‡ Torreya, x. (1910) pp. 94-5.

§ Kryptogamenflora der Mark Brandenburg, iii. heft 4 (1910) pp. i-x. (1-29), 497-712.

Flora of Bremen.*—F. Hustedt continues his contributions to the flora of Bremen, and describes the Bacillariaceæ of the Ochthum, a tributary of the Weser. He observed altogether 148 species belonging to 33 genera. Comparisons are given between this flora and the species previously examined by the author from a moorland canal. Critical notes are added to some of the records.

Algæ of the Tatra Mountains.†—R. Gutwinski publishes a flora of the algæ of the Tatra mountains. His work is divided into four sections, which deal with the position and character of the Tatra mountains, a review of past work on the algæ of the district, problems concerning the algal flora of the Tatra, and a systematic enumeration of species. 129 genera are recorded, and 827 species, of which 11 species and 28 varieties or forms are new. These are all figured. Critical remarks are also appended to some of the already known species.

Algæ of Trebizond.‡—S. Stockmayer has worked out the collections of marine, fresh-water, and brackish-water algæ made by Handel-Mazzetti in the district of Trebizond. Before enumerating the species found, the author gives a résumé of previous work done on the algæ of the Black Sea and Asia Minor, with notes on the climate, topography, and geology of the region. The collections contain 60 marine species, 67 fresh-water, and 5 brackish-water. Of these, 61 fresh-water species are new for Asia Minor, and 8 marine for the Black Sea. Notes on geographical distribution are added, and remarks on the varieties of *Synedra affinis*.

Black Sea Algæ.§—N. N. Woronichin records a species new to the Black Sea, *Castagnea mediterranea* Bornet. He collected it himself in an excursion to the Crimea, and found it also among Black Sea algæ in Charkow University, and in the Sebastopol Biological Station. This alga is peculiar in that it was growing on stones, whereas *C. mediterranea* generally grows epiphytically. The author also examined specimens of *Chorda Filum*, collected in 1869 by Sperk, and in 1889 by Perejaslawzew. These specimens proved to be not very typical plants of *Scytosiphon lomentarius* J. Ag., characterized by the small size of the thallus, the absence of constrictions, and the more compact structure. *Chorda Filum* must therefore be struck out of the list of Black Sea algæ.

Russian Fresh-water Algæ.||—A. A. Elenkin publishes a first contribution concerning new, rare, or interesting species and forms of algæ collected in Central Russia. He describes a new species of *Anabaena*, *A. Scheremetievi*, with varieties and forms, and also gives critical descriptions of other species and varieties of the genus. He considers that *A. spiroides* is very closely allied to a variety of his new species, and that both these, together with *A. Bergii*, *A. planctonica*, *A. caspica*, *A. macrospora*, *A. sphaerica*, and probably *A. Wernerii*, are phylogenetically allied, forming a natural group, which the author designates subsection *Scheremetievi*.

* Abh. Nat. Ver. Bremen, xx. (1909) pp. 91-120.

† Bull. Internat. Acad. Sci. Cracovie. (1909) pp. 415-560.

‡ Ann. k.k. Nat. Hofmus. Wien (1909) pp. 55-100.

§ Bull. Jard. Imp. Bot. St. Pétersbourg, x. (1910) pp. 78-84.

|| Op. cit., ix. (1909) pp. 121-54.

Japanese Algæ.*—K. Okamura publishes a further part of his *Icones of Japanese Algæ*, containing plates of *Cryptonemia Schmitziana*, *Desmarestia ligulata*, *D. viridis*, and *D. latifrons*. The structure of *Desmarestia* is well figured, showing the corticating filaments of the stem.

New Fossil Fucoid.†—A. Hollick describes and figures a specimen found by him in the Museum of the New York Botanical Garden, under the name of "*Haliserites* sp." It was collected at Franklin, Delaware Co., N.Y. The author discusses the systematic position of this fossil, as to whether it should be regarded as belonging to *Haliserites* or not, and shows that it belongs to *Thamnocladus*. He gives a diagnosis of it under the name of *Thamnocladus passifrons*.

MAZZA, A.—Saggio di Algologia Oceanica. (Marine algology.)

[A continuation of this author's work on marine algæ]

Nuov. Notar., xxi. (1910) pp 65-99, 125-52.

Fungi.

(BY A. LORRAIN SMITH, F.L.S.)

New Chytridiaceous Fungus.‡—Olive Hood discovered the new fungus in the colonies of *Eudorina elegans*. The parasite was most evident in the early autumn months, as the zoogonidia at that time attack the *Eudorina* colonies; the parasite (zoogonidium) becomes attached to the gelatinous envelope of the *Eudorina* by the pointed end, and gradually penetrates the cells of the interior where a new zoogonidium is formed. The zoogonidia, when mature, escape into the water, and increase in size before they attack a new host. The fungus has been named *Rhizophidium Eudorinæ*.

Fresh-water Phycomycetes.§—H. E. Petersen has studied these in Denmark. He considers that the Chytridineæ are derived from higher Phycomycetes, or from algæ, and he dissents from the view of Dangeard and E. Fischer, that they descend from the Monadineæ. The formation of mycelium from the zoospore separates the Monadineæ from the Chytridineæ.

Submersed Phycomycetes may be found in any tranquil water not containing much ferric-oxide; they attach themselves usually to branches of trees, and may survive the winter in vegetative form, though it is usually by the spores that they live through the cold period. The author found seventy species in Denmark, twelve of these being new to science. One new genus is described, *Pithiomorpha*.

Cytology of *Albugo candida* and *Peronospora Ficariæ*.||—Fritz Kruger cites the work of recent writers on nuclear division in the

* *Icones of Japanese Algæ*, ii. No. 5 (1910) pls. 71-5.

† *Bull. Torrey Bot. Club.*, xxxvii. (1910) pp. 305-7 (1 pl.).

‡ *Proc. Birm. Nat. Hist. Soc.*, xii. (1910) pp. 38-45 (5 figs.).

§ *Bot. Tidsskr.*, xxix. (1909) pp. 345-440 (28 figs.). See also *Bot. Centralbl.*, exiii. (1910) pp. 611-12.

|| *Centralbl. Bakt.*, xxvii. (1910) pp. 186-205 (2 pls.).

Peronosporineae, and proceeds to examine the statement that there is a reduction of chromatin substance before fertilization. He describes his working methods, and gives a full account of his research of the two fungi, more particularly of *Albugo candida*. He found that in the development of the sexual organs of both forms there was only one nuclear division that differed in any way from the typical karyokinesis, and the nuclei resulting from this division, both male and female, have the same number of chromosomes as the vegetative nucleus. The two gamete-nuclei lie together for some time before fusing to form the primary oospore nucleus. This zygote nucleus differs from all the others in the amount of chromatin it contains. After a certain time, when certain changes of structure have taken place, division occurs: the spindle of this division is much longer than those of the other divisions, and the arrangement of the chromosomes on the equatorial plate is much looser. At the ends of the spindle are small, dark bodies, probably centrosomes. The division may be considered as heterotypic. The daughter-nuclei of the zygote nucleus undergo simultaneous division, and the number of chromosomes was about sixteen; those of the zygote nucleus were more, but their number could not be accurately determined owing to the structure of the nucleus, and the difficulty in obtaining good preparations of that stage.

Vine Roesleria.*—Roesleria of the vine is due to a fungus, *Vibrissia hypogæa*, an Ascomycete parasitic on the roots. P. Viala and P. Pacottet have cultivated the spores of the fungus in solids and fluids, and have reproduced the conidial stages. On the solid media were formed thick layers of green mycelium and numerous conidiophores. On the liquid cultures they obtained the same green mycelium, with spongy spherical bodies formed in the liquid, on the exterior of which were numerous tubes, some of them swollen in a succession of balls. These balls became finally green spores.

Trochila Populorum.†—C. W. Edgerton has been making cultures of this fungus, to try and link it up with *Marssonia castagnei*, Potebnia having hazarded the opinion that the two fungi were life-stages of the same species. Both grow on poplars. Edgerton has not been wholly successful, but he found a *Trochila* always growing on *Marssonia* spots, which he diagnosed as *T. Populorum*. He gives a minute description of the fungus.

Studies in Pyrophilous Fungi.‡—It has been a debated question as to the reason why certain fungi, such as *Pyronema*, only grow on burnt soil. F. J. Seaver and E. D. Clark have examined the soils chemically, and have compared the heated with the unheated. They have come to quite definite conclusions as to the value of the heating process; they find that heat renders soluble a great amount of material in the soil, and thus makes it available as food for fungi. They tested their results in various ways, and a full account is given of the various experiments. Soil subjected either to steam or dry heat (either in a closed oven or by

* Comptes Rendus, cl. (1910) pp. 1770-1.

† Mycologia, ii. (1910) pp. 169-73 (7 figs.)

‡ Tom. cit., pp. 109-24 (3 pls.).

burning over the surface of the soil) becomes a favourable nutrient medium for other fungi besides *Pyronema*, and they judge that it is, in all cases, due to the large amount of food substances rendered suitable for fungoid growth.

Monascus.—R. E. Buchanan* has been led to examine the moulds that appear on silage, as many farm animals, especially horses, had died after eating mouldy silage. Many moulds belonging to the genera *Penicillium*, *Aspergillus*, and *Mucor* were isolated and cultivated; in one instance the only mould present was *Monascus purpureus*, not previously recorded from America. It is the characteristic mould used in Eastern Asia for the preparation of red-rice (Ang-quac). Though eleven horses died after eating the silage where *Monascus* occurred, the author is not certain yet of its pathogenic properties.

Charles E. Lewis † describes a growth of *Monascus Barkeri* which was found in a bottle of pickles from Chicago; it is also new to America, and probably the spores were imported with some of the spices used in preparing the pickles.

North American Hypocreales. II. ‡—F. J. Seaver publishes two new species, *Macbridella olivacea* and *Nectria zonata*, with studies of their life-histories. He made cultures of the fungi of *Macbridella* on palm stems and of *Nectria* on the outside of plant-pots, where it was originally found creeping over green algæ, such as *Protococcus*. Both species were associated with conidial forms belonging to the genus *Verticillium*.

Oak-mildew. §—E. J. Klein reports that the mildew appeared in Luxemburg in the beginning of spring in 1907 while a south-west wind was blowing, and he argues that it must therefore have come from some western locality. His opinion is that it is unconnected with any known oak-mildew in Europe.

Fusion of Yeast-cells. ||—A. Guilliermond reviews the different publications on the fusion of yeast-cells before ascus formation, and makes a comparative survey of the whole question. He finds that copulation is fairly frequent in yeast-cells, and that there is a great similarity in the process among the different forms. With the exception of *Schizosaccharomyces octosporus*, in which there is complete fusion, the two fusing cells remaining distinct with a neck or bridge between them. Fusion may take place in quite small colonies, and the cells in that case must be nearly related, in some cases sister-cells. They may differ in size, but that does not indicate difference in sex, it is merely a stage of development. Guilliermond repeats that the yeasts are evidently a group in which sexuality tends to disappear and to give place to parthenogenesis. He finds all stages among the forms that have been examined: those that show complete fusion, those in which it has disappeared leaving traces behind, those in which there is no indication of fusion, and finally, as in *Saccharomyces Ludwigi*, where the spores fuse on germinating.

* Mycologia, ii. (1910) pp. 99-106 (2 pl.).

† Tom. cit., p. 174.

‡ Tom. cit., pp. 175-82 (1 pl., 1 fig.).

§ Naturalistes luxembourgeois, ii. (1910) pp. 50-2. See also Bot. Centralbl., cxiv. (1910) p. 12.

|| Ann. Mycol., viii. (1910) pp. 287-97 (10 figs.).

Study of Torula Fungi.*—Arthur Geiger selected four organisms from the wort of a brewery that were not true yeasts, and has studied them under every aspect: morphologically, including the form, size, and contents of the cells, the cell-bands, growth on the various substrata, and formation of the cell-walls; physiologically, the examination consisted of the re-action of the cells to various sugars, acids, and alcohols. Finally, he tested their behaviour under changes of temperature. Geiger determined all four as new species—*Pseudomonilia albomarginata*, *P. rubescens* (the giant colonies red-coloured), *P. mesenterica*, and *P. cartilaginosa*. Full descriptions are given of these and of the results of the various culture experiments. In addition, fourteen tables have been drawn up, giving comparative percentages and results.

Yeast-cells of Endomyces albicans.†—Henry Pénau cultivated the fungus on carrot, beetroot, and potato. He describes his methods of work and the changes in the development of the cells. He supports Guilliermond's views on the yeast-cell, and found, as he did, a metachromatic corpuscle and a nucleus, the latter extremely small and possibly possessing only one chromatin granule. It is always attached to the vacuole of the metachromatic corpuscle. At the time of cell-division the cytoplasm buds out and the nuclear granule divides into two equal minute chromatic masses, one of them passing over into the daughter-cell.

Functions of Yeast.‡—W. Stanley Smith publishes a paper on yeast from an industrial point of view. He discusses chiefly the environment and the changes that are brought about by the quality of the food presented to the yeast-plant in the wort used in brewing. He discusses the different kinds of beer manufactured and the conditions that affect the taste, etc., of the products of brewing. He also discusses various chemical questions in connexion with the fermentation process.

Systematic Study of Hendersonia.§—Ernst Voges has examined a large number of species of this genus, and he finds that the presence or absence of the pycnidium is not a sufficiently decisive character in determining the systematic position of genera. He considers that the character and habit as a whole must be taken into account. In the case of *Hendersonia*, nearly related forms would be widely separated if isolated features alone were dwelt upon, some of the species being classified among Sphaeropsidales, others among Melanconiales. Voges found very marked differences in the form and development of the pycnidia of *Hendersonia* species on the same branch; in some cases the fruiting body was wholly immersed, in others the epidermis was burst and the pycnidium laid open. He did not find any further fruiting-form in connexion with this fungus.

Culture Studies of Species of Penicillium.||—Ch. Thom lays down as an essential, in describing species of this genus, that they should be

* Centralbl. Bakt., xxvii. (1910) pp. 97–149 (1 pl. and 14 figs.).

† Comptes Rendus, cli. (1910) pp. 252–4.

‡ Journ. Inst. Brewing, xvi. (1910) pp. 456–68.

§ Bot. Zeit., lxxviii. (1910) pp. 87–100 (10 figs.).

|| U.S. Dept. Agric. Bur. Anim. Ind. Bull. No. 118 (1910) 107 pp. (36 figs.). See also Ann. Mycol., viii. (1910) p. 418.

cultivated on the same medium, otherwise confusion arises, as they develop so differently on various substrata. He himself has followed this method, and yet he has found thirteen new growths that he has been unable to place in any species already described; these he considers as new. He has figured and described the various forms morphologically and physiologically.

Important Entomogenous Fungus.*—H. S. Fawcett describes a new fungus, *Aegerita Webberi*, which lives on the white fly larvæ. The white fly, *Aleyrodis Citri*, is very destructive to orange trees, and the spread of the fungus is secured by artificial methods, either by pinning fungoid leaves among those affected by white fly, or by spraying the trees with water which contains the spores of the fungus. Whenever the atmospheric conditions are favourable to the growth of these fungi, fair success in checking the white fly has been attained. A full description of the fungus is given and of its development on the larvæ.

Hypophycetes.†—The recent fascicle issued by G. Lindau completes the work of addition and revision. Most of it is occupied by a key to the genera, and by an index of plants and various substances which serve as hosts, or as substrata, to the various moulds.

Peridial Cells in the Roesteliæ.‡—F. D. Kern finds that the peridium of the *Roesteliæ* is very characteristic and quite sufficient to distinguish the genus from other Uredineæ. He notes the way in which the individual cells are joined together, usually so loosely that they separate easily, and this accounts for the split and ragged condition of most of the peridial walls. The size of the cells varies in the different species, both in length and breadth; the thickness of the cell-wall is also to be noted; usually it is thinner on the inner wall than on the others. Only two species have smooth cell-walls, in all the others there is more or less sculpturing, usually ridges or ridge-like markings. The peridial cells of the different species are figured.

Germination of Uredospores of Hemileia vastatrix.§—F. C. von Faber has studied the process of infection of coffee leaves by the spores of *Hemileia* in Java. They germinate readily on both sides of the leaf, but infection takes place through the stomata and only on the under side. Infection does not take place in too great moisture, even though germinating tubes are formed; it is only when there has been considerable transpiration from the leaf that the fungus is able to enter the tissues, and then it is by means of suckers which develop on the germinating tube. The uredospores germinate in darkness or in weak light, and more readily in a short strong illumination, which seems to act as a stimulant, especially after a period of darkness. Longer illumination has a harmful influence on the uredospores. The blue violet rays exercise a favourable influence if of short duration, but they kill the spores that are exposed to them for a long time.

* Mycologia, ii. (1910) pp. 164-68 (2 pls.).

† Rabenhorst's Kryptogamen-Flora, abt. 9, lief. 118 (Leipzig, 1910) pp. 817-80.

‡ Bot. Gaz., xlix. (1910) pp. 445-52 (2 pls. and 2 figs.).

§ Ber. Deutsch. Bot. Gesell., xxviii. (1910) pp. 138-47.

Development of the *Æcidium*.*—A. F. Pavolini is engaged in the study of the *Æcidium* of *Uromyces Dactylidis* and publishes a preliminary note on the results of his work. He gives a sketch of the work done and of the views held on the question of sexuality in the *Æcidium* by Masee, Neumann, Sappin-Trouffy, Blackman and Christman. Pavolini selected this species of *Uromyces* as not only Masee and Neumann, but Blackman and Fraser in their last paper deal with this form. He collected specimens of different ages on the leaves of *Ranunculus Ficaria*. In the youngest stages of the *Æcidium* he noted an irregular mass of uninucleate hyphæ, the lower more compact and with more dense protoplasmic contents than the upper. At a later stage the hyphæ are arranged in parallel or slightly oblique lines, the upper cells of which are already binucleate. The nuclei lie side by side or superposed, the difference in position being caused by the position of the cell from which the second nucleus has migrated; occasionally the parallel hyphæ are bifurcate. The binucleate cells after repeated division form the mother-cells of the acidiospores. The author, therefore, sees here a case of reduced fecundation with equal gametes. He saw no instance of division in uninucleate hyphæ, the double condition being always due to migration. Cells were seen with three or four nuclei, but the reason of that may possibly be pathological, or due perhaps to the disappearance of the membrane between two cells. He is not sure yet if "migration" be the proper term to use in the uniting of the nuclei. A superficial layer of sterile cells was not seen, all the cells seemed to be normally nucleate and equally functional. The two conjugate nuclei remain distinct until the development of the teleutospore, when fusion takes place.

Uredineæ.†—W. Tranzschel publishes results of his culture experiments during 1906 and 1907. He finds that *Puccinia Porri* is one of the Hemipucciniæ, the sporidia producing only uredospores; that *P. Eriophori* forms æcidia on *Senecio paluster* and *Ligularia sibirica*. The *Æcidium*-form of *Puccinia litoralis* was developed on *Sonchus arvensis*, *S. asper*, and *S. oleraceus*; *Æcidium Trollii* is connected with *Puccinia Dietrichiana* on *Argopyrum caninum*. Other less important results are also chronicled.

The same author ‡ has written a paper on *Æcidium*-forms with golden-brown spore-membranes. He gives descriptions of the species with that type of spore; they were mostly collected in Eastern countries.

Trabut § reports a rust on cabbages at Sidi-Aïssa, due to *Æcidium Brassicæ* sp. n. The gardens were surrounded by ditches filled with *Phragmites isiaica*. Trabut thinks the *Æcidium* may belong to the rust *Puccinia isiaicæ*.

Coloured Drawings of Mushrooms, edible and poisonous.||—A series of coloured drawings of field and cultivated mushrooms, and

* Bull. Soc. Bot. Ital. (1910) pp. 83-8.

† Arb. Bot. Mus. k. Akad. Wiss. St. Petersburg, vii. (1909) pp. 1-19. See also Ann. Mycol., viii. (1910) p. 415.

‡ Tom. cit., pp. 111-16. See also Ann. Mycol., viii. (1910) p. 415.

§ Rev. Hort. Algerie, xi. (1907) pp. 285-6. See also Bot. Centralbl., cxiii. (1910) p. 632.

|| Guide to Worthington Smith's Drawings of Field and Cultivated Mushrooms and Poisonous or Worthless Fungi often mistaken for Mushrooms. British Museum (Natural History), 1910, 22 pp. (with text figs. and large coloured plates).

poisonous or worthless fungi which are often mistaken for them, has been issued in pamphlet form by the Trustees of the British Museum. The drawings are reproduced on a reduced scale from a beautiful series by W. G. Smith which is exhibited in the Department of Botany, and are accompanied by a descriptive text.

Notes on the Larger Fungi.—A further series of coloured plates of edible fungi have been printed,* with descriptive letterpress. These are *Craterellus cornucopioides*, *Lycoperdon giganteum*, and *Boletus edulis*. Notes are given as to the methods of cooking.

In a further issue of the Journal† two species of poisonous Agarics are figured and described: *Amanita mappa*, which is easily avoided as it has a strong unpleasant smell, and *A. pantherina*, which has a dusky brown cap covered with whitish warts. Both of these grow on the ground, chiefly in woods.

Wilmer G. Stober‡ gives a list of the larger fungi found near Oxford, Ohio. He adds descriptive notes; the species are all American.

W. A. Merrill§ publishes a coloured plate and descriptions of ten species of *Hygrophori*, the most common species in the United States. Eight of them are also common in Great Britain.

Distribution of Poisons in Mushrooms.||—W. W. Ford has investigated several species of *Amanita* to test their poisonous qualities. He found that in a carefully prepared extract of *Amanita phalloides* there were two poisons: amanita-hæmolysine, a glucoside, and amanita-toxine, which is the more poisonous. He found the same substances in *A. virosa*, *A. spreata*, and *A. verna*. Other species that he examined contained a similar toxine, but no hæmolysine; they are, none the less, deadly poisonous. *A. Frostiana*, considered to be a variety of *A. muscaria*, was found to be without either of these two poisons, and Ford concludes that it cannot be nearly related to *A. muscaria*.

Chilian Fungi.¶—C. Spegazzini has described 326 species of fungi for Chili, very little having been known previously of the fungi of that region. He has found many new species, and these are described in Latin. Critical notes in Spanish accompany most of the species. The new genera described are *Physalosporella* and *Paranthostomella* (Sphaeriaceæ); *Sphæronemopsis* (Sphaeropsidææ); *Lophodermopsis* (Lophostomataceæ); *Stemphyliopsis*, *Volutellopsis*, and *Myriophysetta* (Hyphomycetes).

Servian Fungi.** — In preparing the list of fungi for Servia, N. Ranojević describes the journeys that he undertook in the neighbourhood of Belgrade at different times of the year, and longer travels to more distant regions. He has collected or identified 647 species,

* Journ. Board Agric., xvii. (1910) pp. 217-18 (3 pls.).

† Tom. cit., pp. 301-2 (2 pls.).

‡ Ohio Nat., x. (1910) pp. 177-8.

§ Mycologia, ii. (1910) pp. 159-63 (1 col. pl.).

|| Science, n.s., xxx. (1909) pp. 97-108. See also Ann. Mycol., viii. (1910) pp. 419-20.

¶ Buenos Aires (1910) 205 pp. (text figs.). See also Hedwigia, l. Beibl. (1910) pp. 59-60.

** Ann. Mycol., viii. (1910) pp. 347-402 (12 figs.).

including 2 new genera, 28 new species, and a new variety. Among the fungi, 25 species of Mycetozoa find place. The new genera are *Pseudolachnea*, a member of the Excipulaceæ in which the fruit simulates a *Peziza*, and *Ranojevičea* (Tuberculariaceæ) with forked conidiophores terminating in two sterigmata.

Catalogue of Irish Fungi.*—J. Adams and G. H. Pethybridge have recently issued their list of all the fungi hitherto recorded in Ireland. Their first record is taken from Threlkeld's *Synopsis Stirpium Hibernicarum*, published in 1726, which contains the names of 19 species of fungi found in Ireland. The first serious investigator was John Templeton, who collected and named 232 species prior to 1800, though not published till Taylor prepared a catalogue in 1840. The authors' list contains 1464 species, but they consider that it probably represents less than half the fungal flora of the country. The Basidiomycetes are most largely represented by 711 species, after them the Ascomycetes with 344 species. A full bibliography is added.

Mycological Notes. II.†—C. Ferdinandsen and O. Winge publish notes on a series of fungi. *Cladochytrium Myriophylli* was placed with its host *Myriophyllum verticillatum* in a glass of water, and both sank to the bottom during the winter. In May the resting-spore became a sporangium with zoospores. The development of *Sebacina caesia* was watched; the crust thickened by the gradual formation of new basidia; specimens of *Galactinia savirosa* were found with blue milk. Other fungi are commented on and their proper affinities given, and some new species are described.

Ambrosia Fungi.‡—J. Beauverie has brought to a conclusion the account of his researches on the fungi cultivated by wood-boring insects. Neger had already established the fact that these insects used such beds of fungi as nourishment. Beauverie has reviewed Neger's work and added his own results. He finds that the fungi draw from the woody tissues nitrogenous substances and present them in a concentrated form, a great advantage to the insects. Ambrosia-eating insects bore their galleries only in rather fresh material and always in sap-wood, as only in such conditions could the fungus develop properly and find the aeration necessary for growth, and it is noteworthy that these galleries never traverse wood previously contaminated in any way. It has been impossible to determine accurately the fungus in the galleries of *Tomicus dispar*, but Beauverie found *Dematium* forms, and in the stroma formed of the hyphæ in the galleries were empty hollow cases which may be undeveloped pycnidia of a *Macrophoma*. Figures and descriptions referring to the whole work are published.

Review of Plant Diseases.§—M. Hollrung's yearly volume on plant diseases has just been issued, dealing with the material published on this

* Proc. Roy. Irish Acad., xxviii. (1910) pp. 120-66.

† Bot. Tidsskr., xxix. (1909) pp. 305-19. See also Bot. Centralbl., cxiii. (1910) pp. 627-8.

‡ Ann. Sci. Nat. Bot., sér. 9, xi. (1910) pp. 65-73 (5 pls. and 10 figs.).

§ Jahresb. Pflanzenkr., xi. (1908). Berlin: Paul Parey (1910) vii. and 362 pp.

subject during the year 1908. The sections are headed: A. Pathological plant anatomy; B. General plant pathology; C. Special plant pathology; D. Plant hygiene; E. Plant-therapy; F. Advancement of phytopathology and plant protection. Diseases caused by animals as well as by fungi are included in the survey so far as they have been noted or studied during the year. The literature of each subject is given at the end of the chapter dealing with it, and also at the beginning of the sections, and there is a full general index to the whole volume.

American Text-book of Plant Diseases.*—B. M. Duggar has included in his account of plant diseases the work done in recent years in the different agricultural stations throughout the United States. He gives a brief historical account of the subject. The general text of the book falls into three parts: (1) culture methods and technic; (2) physiological relations, and (3) fungous diseases of plants. The diseases are grouped according to the fungus causing them, under Phycomycetes, Ascomycetes, etc., and special attention is given to the influence of environment on the development of the fungi; methods of control or of cure are also dwelt on.

Plant Diseases.—J. B. Parker† describes a disease of *Catalpa* leaves due to a fungus, *Didymosphæria Catalpæ* sp. n. The minute perithecia grew on pale spots of the leaf, both on the upper and under surfaces. The author compares the effect of the fungus with that of other parasites on the same leaves.

W. W. Gilbert ‡ has examined the root-rot of tobacco plants caused by *Thielavia basicola*. It induces dwarfing of the plants and finally kills them. The causes that aid the development of the fungus are a soil too rich in humus, excessive moisture, and lack of air in the tobacco beds.

A description § of shot-hole fungus, *Cercospora circumcissa*, has been published by the Board of Agriculture. The first indication of the disease is the presence of small pale spots on the leaf, which become yellow; the fungus itself becomes visible later, tufts of threads with spores at the tips. In time the diseased patches of leaf-tissue drop out, leaving a hole. Peach, almond, cherry, apricot and nectarine are liable to be attacked by the fungus. An account of a useful sulphur spray is also given. It acts as a most efficient fungicide.

A bad attack of currant black-knot|| (*Plowrightia ribesia*) was reported from a garden near Cambridge, and also from Swavesey in the same county. A further case was reported from Middlesex. Most of the trees attacked had died. Corky-scab of potatoes (*Spongospora scabies*) has appeared in several localities. Other diseases submitted to the Board of Agriculture affected apple-trees (mildew), Douglas Fir seedlings (probably *Dothiorella pithya*) and periwinkle (*Puccinia Vincæ*). Cucumber

* Fungous Diseases of Plants. Boston: Guin and Co. (undated) xii. and 240 pp. (240 figs.). See also Bot. Gaz., 1. (1910) pp. 65-7.

† Ohio Nat., ix. (1909) pp. 509-12 (1 pl.). See also Centralbl. Bakt., xxvii. (1910) p. 272.

‡ U.S. Bureau Plant Ind. Bull., No. 158 (1909) 55 pp. (5 pls.). See also Centralbl. Bakt., xxvii. (1910) pp. 272-3.

§ Journ. Board Agric., xvii. (1910) pp. 211-15.

|| Tom. cit., pp. 215-17.

and tomato canker has been discovered in several new localities—four cases were reported from Kenilworth and one from Guernsey.

In a more recent number of the *Journal** several fungoid attacks are reported; *Phyllosticta prunicola* was found on the leaves of Cox's orange pippin. American gooseberry mildew has been doing serious damage in districts where due care had not been taken to ward off the attack; several fungi have been found on tomato plants doing more or less damage; these were *Fusarium Lycopersici* and *Cladosporium epiphyllum*. From Long Niddry in East Lothian *Sphaerella tubifica* was reported on mangolds, and from Boston celery plants were sent that were suffering from an attack by the fungus *Sclerotinia sclerotiorum*.

E. Barsali † states that pine cones in the neighbourhood of Pisa did not develop properly and became pale straw-coloured. There were minute black points on the cone-scales that proved to be the pycnidia of a *Diplodia*, but he scarcely considered these the cause of the mischief; it was rather due in part at least to the common mould, *Tricothecium roseum*. Anything that impaired the vigour of the tree aided the growth of the fungus.

In a leaflet ‡ published by the Board of Agriculture leaf-shedding in Conifers is said to be caused by the attack of the fungus *Botrytis cinerea*. The first indication of the disease is a yellowing of the leaves. The affected shoots are twisted or curved downwards. Seedlings suffer most. All diseased seedlings and leaves should be collected and burned.

Another leaflet § deals with celery leaf-spot. It is caused by *Phyllosticta Apii* and was first detected in the United States. It appeared in epidemic form in Sussex in 1909 in a field of celery, and much damage was caused. Another celery-leaf disease is caused by *Septoria Petroselini*. It has long been known in this country and on the Continent. Spraying with Bordeaux mixture is advised in both cases of disease.

George Grant Hedgcock || has been searching for the cause of "pinrot" or "peckiness" in the incense cedar of California and Oregon, by which great injury is done to the heart-wood of the tree. He ascribes the disease to *Polyporus amarus* sp. n.

BALLAND & DROZ—Sur l'Aspergillus niger des tanneries.

[Account of an attempt to free the tanneries from *Aspergillus niger*.]

Journ. Pharm. et Chimie, sér. 6, xxix. (1909) pp. 573-75.

See also *Bot. Centralbl.*, cxiii. (1910) p. 627.

BIGEARD & GUILLEMIN—Flore des Champignons supérieurs de France les plus importants à connaître. (Flora of the most important of the higher fungi of France.) Chalons-sur-Saône: E. Bertrand, 1909, xvi. and 600 pp. (56 pls.).

See also *Bot. Centralbl.*, cxiii. (1910) p. 627.

DIETEL, P.—Uridineen aus Japan. III.

[List of species with notes. There are several new species and one new genus, *Nothoravenelia*.] *Ann. Mycol.*, viii. (1910) pp. 304-14.

* *Journ. Board Agric.*, pp. 300-1.

† *Bull. Soc. Bot. Ital.* (1910) pp. 80-3.

‡ *Board of Agric. and Fish., Leaflet No. 234, 3 pp. (1 pl.).*

§ *Op. cit.*, Leaflet No. 238, 2 pp. (5 figs.).

|| *Mycologia*, ii. (1910) pp. 155-6.

- FAIRMAN, CH. E.—**Fungi Lyndonvillenses novi vel minus cogniti.** (Fungi of Lyndonville, new or rare.)
[New and rare species of microfungi collected at Lyndonville in New York State.] *Tom. cit.*, pp. 322-32.
- FISCHER, ED.—**Beiträge zur Morphologie und Systematik der Phalloideen.** (Contribution to the morphology and classification of the Phalloideæ.)
[The author discusses *Clathrella delicata*, *Dictyophora irpicina*, and *Mutinus elegans*.] *Tom. cit.*, pp. 314-22 (1 pl.).
- FRIES, TH.—**Skandinaviens tryfflar och tryffelkännande svampar.** (The truffles and truffle-like fungi of Scandinavia.)
Svensk. bot. Tidsskr. (1909) pp. 223-300.
See also *Bot. Centralbl.*, cxiv. (1910) pp 9-10.
- HAGEN, OSCAR—**Neue untersuchungen über Norwegische Mucorineen.** (New research on Norwegian Mucorineæ.)
[Culture experiments and descriptions of new species.]
Ann. Mycol., viii. (1910) pp. 265-80 (11 figs.)
- JUEL, O.—**Taphrina species on Betula.**
[Ten species are recorded. Notes are given of these.]
Svensk. Bot. Tidsskr. (1909) pp. 183-91 (3 pls.).
See also *Bot. Centralbl.*, cxiii. (1910) pp. 623-9.
- KEISSLER, KARL VON—**Ueber einige Flechtenparasiten aus dem Thüringer Wald.** (Some lichen parasites from Thuringia.)
[A list of fungi parasitic on lichens collected by G. Lettau.]
Centralbl. Bakt., xxvii. (1910) pp. 208-15.
- LIND, J.—**Fungi (Micromycetes) collected in the Arctic North America (King William Land, King Point, and Herschell Island) by the Gjoa Expedition under Captain Amundsen, 1904-6.**
Selsk. Skr., Math.-Nat. Kl. (1909), 9, 25 pp. (1 pl.) (March 1910).
See also *Bot. Centralbl.*, cxiii. (1910) pp. 610-11.
- LLOYD, C. G.—**Synopsis of the Genus Hexagona.**
[Descriptions of all the well authenticated species.]
Cincinnati, Ohio (June 1910) 46 pp. (55 figs.).
- MAGNUS, P.—**Ein kleiner Beitrag zur Kenntniss parasitischen Pilze Liguriens.** (A small contribution to the knowledge of the parasitic fungi of Liguria.)
[A list of twenty-eight species collected by J. Borrmüller.]
Mitteil. Thüring. Bot. Ver., v. (1910) pp. 13-17.
See also *Hedwigia*, l. Beibl. (1910) pp. 58-9.
- MIGULA, W.—**Kryptogamen-Flora von Deutschland, Deutsch Osterreich, und der Schweiz.** (Cryptogamic flora of Germany, German-Austria, and Switzerland.)
[The fascicle (pp. 431-510) completes the first volume dealing with Myxomycetes, Phycomycetes, Ustilagineæ, and Uredineæ.]
Gera, Friedrich von Zetzschwitz (1910).
- MOESZ, G.—**Magyarországi Cordyceps-ei.** (Magyar.) (The *Cordyceps* species of Hungary.)
[Critical study of species and of probable species of *Cordyceps*.]
Beibl. Bot. Közlemények (1909) pp. 83-91 (1 pl.).
See also *Centralbl. Bakt.*, xxvii. (1910) p. 289.
- MURRILL, W. A.—**The Polyporaceæ of Jamaica.**
[Many new species are described.] *Mycologia*, ii. (1910) pp. 183-97.
- O'KANE, W. C.—**The Ohio Powdery Mildews.**
[List of the Erysiphææ of Ohio, with keys to genera and species.]
Ohio Nat., x. (1910) pp. 166-76 (2 pls.).
- PETROFF, J. P.—**Die Pilze des Moskauer Districts.** (The fungi of the Moscow district.)
[The list includes three Myxomycetes and forty-eight species of fungi.]
Bull. Jard. Imp. Bot. St. Pétersbourg, x. (1910) pp. 1-20. (Russian with German index.) See also *Hedwigia*, l., Beibl. (1910) p. 59.

- RADAIS ET SARTORY—**Sur l'immunisation du Lapin contre le poison des Amanites à phalline.** (On the immunisation of the hare against the phalline poison of *Amanita*.)
[Immunisation was secured by repeated injections of the poison.]
Comptes Rendus, cli. (1910) pp. 156-8.
- REHM—**Ascomycetes exs. Fasc. 46.**
[List with notes of species issued, some of these new to science.]
Ann. Mycol., viii. (1910) pp. 298-304.
- SACCARDO, P. A.—**Notæ Mycologicae.**
[A list of species (several new) from East Africa with notes and a bibliography of East Africa mycological literature. Also a list of new or rare species, mostly European.]
Tom. cit., pp. 332-47.
- SACCARDO, P. A. & J. B. TRAVERSO—**Sylloge fungorum. XIX. Index iconum fungorum enumerans.** [Vol. xix. of the *Sylloge fungorum* being an index to published drawings in alphabetical arrangement, A to L.]
Patavii (1910) 1158 pp. See also *Ann. Mycol.*, viii. (1910) pp. 412-13.
- SPEGAZZINI, C.—**Mycetes Argentinenses (Series IV.)**
[The author lists 612 species of fungi, of which 312 are new to science.]
Anal. Mus. Nac. Buenos Aires, ser. 3, xii. (1909) pp. 257-458 (40 figs.).
See also *Bot. Centralbl.*, cxiii. (1910) pp. 630-2.
- SUMSTINE, D. R.—**The North American Mucorales. I.**
[A systematic account of the group. The name *Rhizopus* is changed to *Mucor*, *Pilobolus* to *Hydrogera*, *Mucor* to *Hydrophora*.]
Mycologia, ii. (1910) pp. 125-54.
- TAKAHASHI, T.—**A Preliminary Note on the Varieties of *Aspergillus Oryzæ*.**
[The writer recognizes three varieties.]
Journ. Coll. Agr. Imp. Univ. Tokyo, i. (1909) pp. 137-40 (6 figs.).
See also *Bot. Centralbl.*, cxiv. (1910) p. 60.
- THEISSEN, F.—**Perisporiales riograndenses.**
[List of genera and species of Microthyriaceæ and Perisporiaceæ.]
Brot. Ser. Bot., ix. (1910) pp. 5-44.
See also *Ann. Mycol.*, viii. (1910) p. 414.
- „ **Marasmii Austro-brasilienses.** (*Marasmius* in S. Brazil.)
[Two new species are included.]
Op. cit., viii. (1909) pp. 53-65 (6 pls.).
See also *Ann. Mycol.*, viii. (1910) p. 414.
- TORREND, C.—**Notes de Mycologie portugaise.**
[A list of species collected at Villa Viçosa (E. Portugal) at Christmas—several new species are described.]
Bull. Soc. Port. Sci. Nat., iii. (1910) pp. 3-7.
- WISNIEWSKI, P.—**Septoria Trapa-natantis.**
[A new fungus parasitic on *Trapa natans*.]
Kosmos (1910) pp. 78-9. See also *Hedwigia*, l. Beibl. (1910) p. 60.

Lichens.

(By A. LORRAIN SMITH.)

Lichen-flora of Bohemia and Moravia.*—Mir Serirt has collected and named a large and representative series of lichens from these countries. He comments on the necessity for immediate action in ascertaining

* *Hedwigia*, l. (1910) pp. 51-85.

the lichen-flora, as so many changes are made in the different localities by the advance of agriculture, or, in the case of limestone rocks, by quarrying the material on which so many rare species have been found. He notes particularly the presence of two crustaceous forms—*Rinodina oreina* f. *Mougeoteoides* and *Acarospora chlorophana*—on Lydite rocks. He found these constantly on the Lydite, and usually in great abundance; and this was the more remarkable as these rocks are usually very barren. He further states that the species are not affected by position or by orientation; they grow equally well in sun or shade, in exposed or sheltered situations. The substratum alone seems to be the factor of importance in their growth. The locality and substratum are given with each species.

CROZALS, A. DE—**Lichens observés dans l'Herault. 1. Lichens d'Agde et de Roquehaute.** (Lichens observed in l'Herault.)

[A list of 27 species of Collemataceæ, 292 lichens, and 22 parasites. The soil is of volcanic origin.]

Bull. Acad. Internat. Géogr. Bot., sér. 3, xvii. (1908) pp. 498-556.

See also *Centralbl. Bakt., xxvii.* (1910) p. 278.

WHELDON, J. A. & ALBERT WILSON—**Inverness and Banff Cryptogams: Lichens.**

[A list of specimens found on the Northern Grampians.]

Journ. Bot., xlviii. (1910) pp. 127-29.

Mycetozoa.

(By A. LORRAIN SMITH.)

Mycetozoa of the Midland Plateau.*—W. B. Grove has found in the country round Birmingham seventy-seven species of Mycetozoa. The localities are in the counties of Warwick, Worcester, and Stafford, and he states that about one-fourth of all the known species have been recorded from these districts. The author gives a short sketch of the group and of their habitat, and notes the manner in which the plasmodium travels to some exposed position for the formation of sporangia. The list includes the locality and the names of the collectors.

Plasmodiophoraceæ.†—René Maire and Adrien Tison publish an account of *Tetramyxa*, a little known genus of Plasmodiophoraceæ. There are only two species, *T. Triglochinis* and *T. parasitica*. The latter grows on *Ruppia* and *Zannichellia*, and is the one that has been examined. It forms tumours on the host-plant, the swelled tissue being due to the active division of the cells irritated by the parasite. In each infected cell there is but one "schizonte," though occasionally several are fused to form a plasmodium. Whilst in this condition the nuclei divide in the manner described in *Plasmodiophora* and *Sorosphæra*. A spore-forming stage follows; the energids forming the plasmodia separate, and the nucleus of each one undergoes two divisions, resulting in four daughter-cells, which become four spores.

* The Fauna of the Midland Plateau. Birm.: Nat. Hist. Soc. (reprint), 1910, 23 pp.

† Comptes Rendus, cl. (1910) pp. 1768-70.

Schizophyta.

Schizomycetes.

Appearance found in certain Bacteria when Examined by the Indian-ink Method.*—G. Sangiorgi calls attention to an appearance seen in bacteria when examined by the indian-ink method. In the centre of the cell, whether of the coccus or bacillus shape, appears a dark inclusion of the same shade as that of the film, and which is therefore in marked contrast with the bright body of the bacterium. The character of the cultivation medium makes no difference, but the appearances are more frequent in young germs than in older ones. The effect of acetic acid and of NOH (1 : 1000) is unfavourable, but dilutions of 1 : 10,000 and upward seem to make no difference. Bacteria killed by boiling do not exhibit the phenomenon. The appearance seems to be associated with the growth and vitality of the organisms.

Chemical and Bacteriological Study of Fresh Eggs.†—Mary E. Pennington examined fifty-seven eggs, and found that seven only were sterile; in the remainder, bacteria, of which thirty-six varieties were identified, were present, both in white and yolk. The chemical data relate mainly to nitrogenous compounds in both white and yolk: nitrogen coagulable by heat, in filtrate, tannic acid precipitate, etc. These details are given in numerous tables.

Endotoxin of *Micrococcus melitensis*.‡—P. N. Bernard finds from animal experiment that bouillon cultures do not become toxic before the fifteenth day. Heated cultures when kept increase in toxicity with age, and after 35 days are twenty times as toxic as cultures of the same age when not heated. The endotoxin is unaffected by heating to 58°C. for 1 hour; the toxicity is diminished by a temperature of 80°. When boiled for 5 minutes the fluid is ten times less toxic than the original; prolonged heating completely destroys the toxin.

Biological and Chemical Studies on Nitroso-bacteria.§—G. E. Gage records experiments made with *Pseudomonas radicola* for the purpose of investigating its nitrogen-fixation when growing in symbiosis with *Trifolium pratense*. The experiments showed that *Pseudomonas radicola* can be isolated from the soil, carried through inoculation experiments, and recovered in a pure state. By cultivating weak strains on nitrogen-free media the nitrogen-fixing property is considerably exalted. Of sugars, maltose suited the organism best. When grown on media containing less than 5 C atoms no gum is produced. In very old cultures, especially on solid media, *P. radicola* develops a membrane which appears cell-like in structure, but does not give the cellulose and starch reactions. Subcultures from these may produce considerable nitrite and

* Centralbl. Bakt., 1te Abt. Orig., lv. (1910) pp. 94-6 (2 figs.).

† Journ. Biol. Chem., vii. (1910) pp. 109-32, through Journ. Chem. Soc., xcvi. and xcvi. ii. 224.

‡ C.R. Soc. Biol. Paris, lxi. (1910) pp. 36-8.

§ Centralbl. Bakt., 2te Abt., xxvii. (1909) pp. 7-48.

nitrate. Though difficult to determine how or when changes in the nitrifying process take place, it is certain that the nitrite stage may be extremely transitory. The presence of sugars greatly accelerates the growth of the organism and the nitrification.

Gram-negative Cocci from the Human Conjunctiva.*—P. Verderame describes three Gram-negative cocci isolated from different cases. Their general characters are as follows: 1. Grows at room temperature; does not liquefy blood-serum; does not hæmolyse the medium in blood-cultures; does not liquefy gelatin; renders broth turbid and forms scum; does not coagulate milk; colonies on agar yellowish grey. 2. Does not liquefy blood-serum; does not grow at room temperature; does not hæmolyse blood-plates; does not liquefy gelatin; renders broth slightly turbid; does not coagulate milk; colonies on agar yellowish to whitish grey. 3. Grows at room temperature; liquefies blood-serum and hæmolyzes blood-media; liquefies gelatin; broth very turbid; coagulates milk; growth on agar iridescent yellowish grey. None of the three are capsulated, or form spores or indol, or produce gas. The first variety evidently belongs to the *M. catarrhalis* group. The second occupies a position intermediate between *Meningococcus* and *M. catarrhalis*. The third coccus belongs to a special group described by Kayser and Ruata, and is sharply differentiated from gonococcus and meningococcus. Most of the cocci appear to have been extracellular and feebly if at all pathogenic to animals and human beings.

Disease of Sheep caused by a Lanceolate Diplococcus.†—A. Gaertner isolated an organism from the bodies of sheep which succumbed from an epidemic disorder affecting chiefly ewes which had recently lambed and also their offspring. The organism is a diplococcus running to chains. It grows well on ordinary media and luxuriantly on blood-agar. Pure cultivation caused the disease in healthy sheep by inhalation, intraperitoneal injection, and feeding. The name *Diplococcus vel Streptococcus lanceolatus ovium* is suggested by the author.

Germs in Mountain Air.‡—B. Galli-Valerio confirms the fact of the diminution of germs in passing from rooms to rooms, to open spaces far from towns, and on mountains. His observations, of which he gives records of 151, show that the presence of man and animals increases the number of germs even of mountain air, and that the number is also increased by the winds if the soil be not wet, frozen, or covered with snow. The observations also showed that while the number of bacteria decreased in passing from rooms to open spaces and to mountains, the organisms then more frequently met with were Hyphomycetes and even Blastomycetes. The only pathogenic species isolated were *M. pyogenes aureus* and *albus*.

Bottle-bacillus.§—H. Dold gives an account of this bacterium, which many dermatologists regard as the causal organism of certain skin diseases,

* Centralbl. Bakt., 1te Abt. Orig., liv. (1910) pp. 523-46 (1 pl.).

† Tom. cit., pp. 546-63.

‡ Tom. cit. pp. 497-521.

§ Op. cit., 1te Abt. Ref., xlvi. (1910) p. 713.

such as pityriasis, acne, and others. It occurs in ovoid, bacillary, bottle-shaped, and thread forms. In consequence of this remarkable polymorphism, it has been difficult to obtain pure cultures. It grows upon all ordinary media. It does not liquefy gelatin nor clot milk. Upon agar, bluish-white colonies of about 2 mm. in diameter appear in 24 to 48 hours. They have a distinct margin. In acid and fluid media a great variety of forms develop. Glucose and lactose are not fermented.

Bacterium anthroposepticum.*—E. Fränkel and E. Pielsticker give this name to a new organism belonging apparently to the hæmorrhagic septicæmia group. It was obtained in cultivations of the blood of a man who developed acute osteomyelitis and septicæmia from an infected wound in the right wrist. The injury was caused by a scratch with a fish-bone. At the autopsy, there were found osteomyelitis and acute infective periostitis, and croupous pneumonia of the left lung. The organism is a short, ovoid, Gram-negative bacillus, showing well marked polar staining, and resembling in general appearance the plague bacillus. It is actively motile, and carries a number of long flagella at one end. It grows well on ordinary media, forming raised, pigmented colonies. On blood media it causes marked hæmolysis. Important diagnostic points are the following: a peculiar aromatic smell in cultures and a characteristic metallic sheen on agar growths. This organism liquefies gelatin, whereas the bacteria of hæmorrhagic septicæmia do not. Animal inoculations showed that fowls and pigeons are immune, but sparrows, white mice, and rabbits can be infected. Inoculation of rabbits produced an early orchitis followed by dyspnœa, increasing weakness of the hinder extremities, and death. Immunising experiments have not yielded any positive results.

Bacterial Parasites of Barley.†—H. Zikes gives an account of certain bacteria frequently found parasitic upon grains of barley. He carried out a number of cultivation experiments in a Schönjahn's apparatus, and observed in many cases the formation of zooglcæa, sometimes yellow, sometimes red. From the yellow zooglcæa he isolated three forms—*Bacterium fluorescens liquefaciens*, *B. herbicola aureum*, and *B. rubrum*. The last-named organism was comparatively rare. *B. herbicola rubrum* was isolated from the red zooglcæa. The author has made a comparative study of the cultural characters of these organisms, the results of which are given in tabular form. *B. herbicola rubrum* and *B. fluorescens liquefaciens* have a deleterious effect upon the roots and cause dwarfing of the plant. Sections of germinating grains infected with these organisms show a destructive infiltration. *B. fluorescens liquefaciens* and *B. herbicola aureum* in symbiosis have also a marked pathogenic effect.

New Variety of Mycosis occurring in Man.‡—V. Babes and T. Minonescu describe two cases of deep suppuration, due to infection with a *Cladothrix*. The pus contained a multitude of small black nodules,

* Centralbl. Bakt., 1^{te} Abt. Ref., xlvi. (1910) pp. 713-15.

† SB. k. Akad. Wiss. Wien, cxix. (1910) pp. 11-32.

‡ Centralbl. Bakt. 1^{te} Abt. Orig., iv. (1910) pp. 108-15.

which were found to consist of interlacing threads showing false branching and intertwined with connective-tissue fibres. In both cases secondary infection with streptococci had occurred, masking the primary infection, which, in the absence of the black nodules, would probably have been overlooked. It was found impossible to obtain satisfactory cultures of the *Cladothrix*, and animal inoculations also gave negative results. In the second case, in which retro-bulbar suppuration proceeding to the formation of a cerebral abscess had caused death, it was possible to demonstrate that the *Cladothrix* forming black masses was the primary cause of the disease.

Bacillus of Typhus Fever.*—During the epidemic of typhus in Moscow in 1909, W. Predtjetchensky examined blood drawn from the veins of a large number of patients, and found a bacillus which he considered to be, in all probability, the causal organism of the disease. In the first place he found the organism in examination of direct films. The blood was oxalated and then lightly centrifugalized. The supernatant fluid was decanted and again centrifugalized. Examination of films prepared from this deposit were found to contain short stout bipolar-staining bacilli. Control examination of blood from patients suffering from other diseases showed no such forms. These bacilli were most abundant between the sixth and the ninth day of the disease.

By inoculating 200 c.cm. flasks of broth with 2.5 c.cm. of blood from the veins of typhus patients, the author obtained, in the great majority of cases, a pure culture of this bacillus. From broth, subcultures were made upon nutrient agar and other media. Milk was clotted in three or four days. Gelatin was not liquefied. The morphological characters were as follows: a short stout Gram-negative bacillus, non-motile and not possessing flagella. Involution forms, ovoid-bacilli and diplo-bacilli in chains were often found. It has points of resemblance on the one hand to *Bacillus pestis*, and on the other to *B. mucosus capsulatus* Fricke. Agglutination experiments and animal inoculations provided further evidence in support of the view that this is the specific organism of typhus.

Scientific Cheesemaking.†—In continuation of his previous paper ‡ upon the subject, P. Mazé deals first of all with the disorders with which cheese may become affected. These may be due to improper development of the organisms which normally participate in the maturation of the cheese. The result is a lack of co-ordination between the various ferments. In other cases, the mischief is due to the introduction of extraneous organisms. In the acid stage, the *Bacillus lartii aerogenes* may gain access and destroy the material. An active gas producer, this organism may rapidly make the cheese into a swollen spongy mass. The black fermentation, dreaded by dairymen, is caused by *Penicillium glaucum*. After the reaction of the clot has become alkaline, *B. subtilis* and the organisms of putrefaction may make their appearance. Further,

* Centralbl. Bakt., 1te Abt. Orig., iv. (1910) pp. 212-18.

† Ann. Inst. Pasteur, xxiv. (1910) pp. 435-66.

‡ See this Journal, ante, p. 498.

the author discusses the empirical selection of ferments and the importance of the quality of milk used. He emphasizes the necessity of pasteurisation.

- BIELECKI, J.—**Sur la variabilité du pouvoir protéolytique de la bactérie charbonneuse.**
Comptes Rendus, cl. (1910) pp. 1548-50.
- CALMETTE, A. & C. GUÉRIN—**Sur la resorption des bacilles tuberculeux chez les Bovidés à la suite de l'injection des mélanges de sérum d'animaux hyper-immunisés et de bacilles cultivés en série sur bile de bœuf.**
Op. cit., cli. (1910) pp. 32-5.
- POYNTON, F. J. & A. PAINE—**Some further investigations and observations upon the pathology of rheumatic fever.**
[Contains further evidence in favour of the authors' views respecting the aetiology of rheumatic fever.] *Lancet* (1910) i., pp. 1524-8 (2 figs.).
- SELIBER, G.—**Sur la Symbiose du bacille butyrique en culture d'autres microbes anaérobies.**
Comptes Rendus, cl. (1910) pp. 1545-7.



MICROSCOPY.

A. Instruments, Accessories, etc.*

(1) Stands.

Old Achromatic Microscope by Trécourt and Georges Oberhaeuser.—This old Microscope, presented by Members of the Council (fig. 78), appears to be one of the early instruments made by Georges

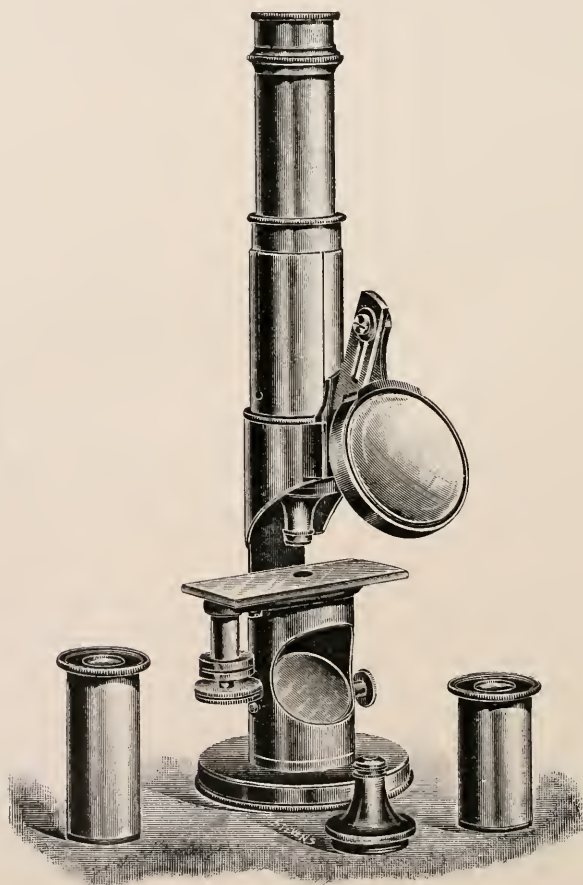

FIG. 78.

* This sub-division contains (1) Stands; (2) Eye-pieces and Objectives; (3) Illuminating and other Apparatus; (4) Photomicrography; (5) Microscopical Optics and Manipulation; (6) Miscellaneous.

Oberhaeuser in Paris, when associated with M. Trécourt, about 1830. The model is based on the "Drum" Microscope, the first form of which was produced in 1742, by Benjamin Martin in his "Pocket

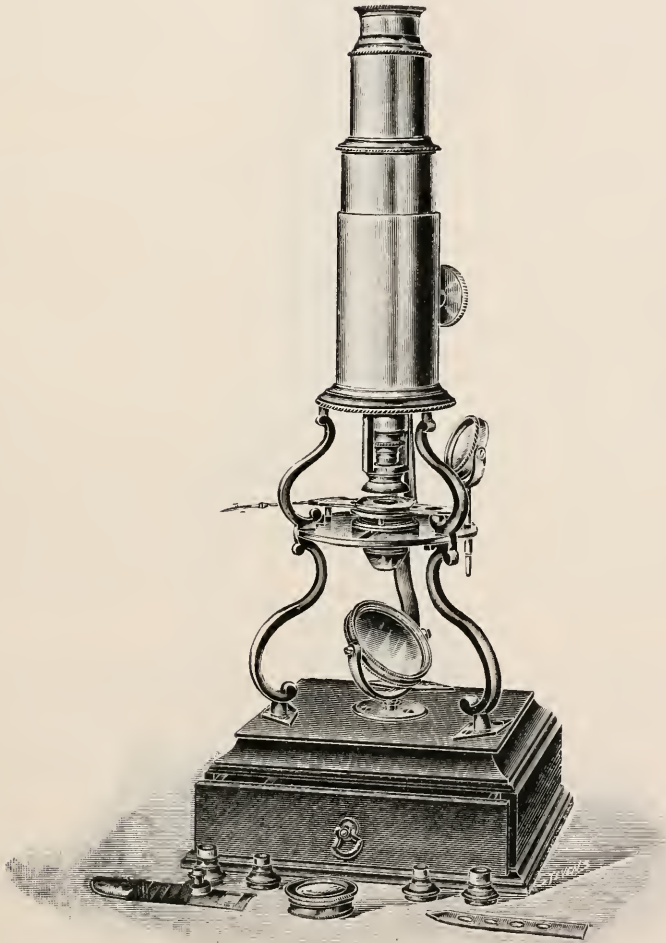

Fig. 79.

Reflecting Microscope." It was afterwards copied with modifications and improvements by Fraunhofer (1811), and many other makers, and has survived to the present day in the cheap form of school Microscopes.

The present instrument is very well finished in brass, mounted on a circular brass base, has a movable concave mirror in the drum, and a bullseye condenser fixed by a dovetailed fitting for the illumination of opaque objects. The coarse-adjustment is effected by sliding tube, and the fine-adjustment by a screw movement to the stage. Nine achromatic objectives are provided, some doublets, and some triplets, ranging in power from 65 mm. to 1.7 mm.; also six eye-pieces (one missing), giving amplifications from 9 to 1790 diameters, according to the table supplied. There is also an eye-piece with needle-points for measuring objects, and two stage micrometers: 1 cm., ruled in 100 parts, and $\frac{1}{2}$ mm., also divided in 100 parts.

Old Microscope presented by Mr. Albert Ash.—This old Microscope (fig. 79) is an improved form of Culpeper and Scarlet's "double reflecting" model, first introduced about 1750, and was called by Adams, in 1798, "the common three-pillared Microscope." It is well made, all in brass, with the three scroll pillars screwed on to the square mahogany box containing the various apparatus; amongst these are a lieberkuhn, concave mirror, bullseye condenser, and six objectives. This model enjoyed great popularity from 1750 onwards on account of its cheapness and handiness, and was extensively copied by all makers of this period. The focusing was effected by sliding the tube carrying the eye-piece and objective up and down the fixed body-tube, but early in the last century, when rack-and-pinion had been generally introduced for the purpose of focusing, this model was further improved by the addition of a rack fixed to the body-tube and working through a slot. This improvement could readily be fixed to the older models, and there is no doubt that this specimen was so altered at some later period, for the colour and lacquer of the brass used for the rack and inner tube are different from that of the rest of the Microscope.

Old Microscope presented by Mr. C. F. Rousselet.—This old Microscope (fig. 80), made entirely of wood and cardboard, is a model which was extensively manufactured at Nürnberg, in Germany, for about a century from 1750 onward. It is a simple and cheap imitation of Culpeper and Scarlet's "three-pillared double reflecting Microscope." The optical part consists of three simple biconvex lenses; two of these, forming the eye-piece, are mounted in a cardboard tube with wooden ends, and are held in position by a wire ring; the third is very much smaller and more convex, is provided with a pin-hole metal diaphragm, and forms the object-glass of about $\frac{1}{2}$ -in. focus. The combination, therefore, is that of a chromatic compound Microscope, giving a total magnification of about 45 diameters. The focusing is effected by sliding the cardboard tube carrying the object-glass up and down the fixed body-tube. A movable plane mirror fixed to the centre of the foot-plate serves to illuminate transparent objects; these were mounted on a wooden slider held in position by a wooden clip and spiral wire spring.

The underside of the wooden base shows a mark burned in with red-hot iron, which is understood to be a Nürnberg trademark.

["The present Microscope formerly belonged to my great-uncle, Charles Garnier, who died in 1869, since when it has been in my possession—it was my first Microscope."—C.F.R.)

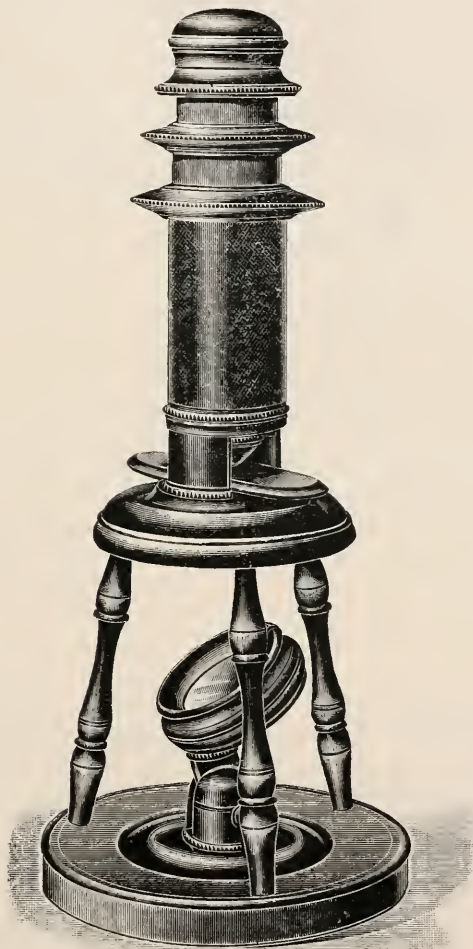

FIG. 80.

Simple Improvements for a Petrographical Microscope.*—Under the above title, A. Johansen suggests four advantageous improvements.

1. *A rotating upper nicol in which the annoying reflection of light from the surface is overcome.* In examining, between cross nicols, minerals which are rather dark, a small amount of light falling upon the upper

* Amer. Journ. Sci., xxix. (1910) pp. 435-8 (4 figs.).

surface of the nicol produces a hazy appearance of the image. Fig. 81 represents a light-tight modification of the upper nicol of the Fuess IIIA Microscope. A vertical section through the carriage is shown at A. A rotating collar *a a'* is moved by the lever *c*, and is supported by the flanges *b b'* of the outer tube in which it rotates. A part of the scale *d*

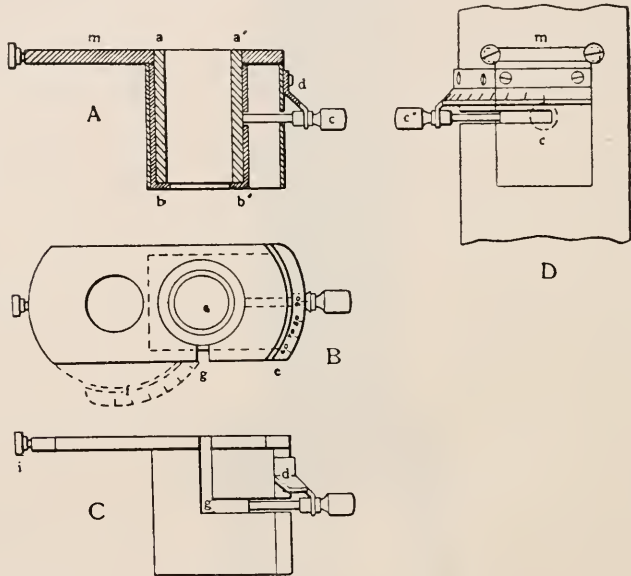

FIG. 81.

is attached to the box and is divided into degrees, although only the 10° divisions are shown at B. B and C are respectively the horizontal and vertical projections. The separation of the scale into two parts, which was made necessary by its lowered position, is shown at *e* and *f*. The slot *g*, which is also shown in C, is for the easy removal of the nicol

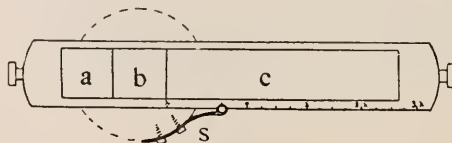

FIG. 82.

from the carriage. The prism is rotated 90° and is lifted out, after the entire carriage is taken from the tube of the Microscope, by the removal of the screw *v*. D is an end view, showing how the plate *m* entirely closes the upper part of the opening in the tube and prevents all reflection from the surface of the nicol. The lever *c* is shown at *c'* rotated through 90° .

2. *A permanently attached combination wedge.*—A great deal of time is ordinarily lost in picking up the accessories to the Microscope and in hunting for the slot into which they are to be inserted. The author has found that the simple contrivance shown in fig. 82 overcomes all this. A carriage, exactly fitting the slot above the objective, is inserted in the tube of the Microscope, and is kept in place by two end screws like those holding the Bertrand lens bar. At one end is a square of gypsum, *a*, giving red of the first order; *b* is an opening; and *c* is a quartz wedge underlain by a mica plate, the two minerals having their directions at right angles to each other, and similar in construction to a Wright

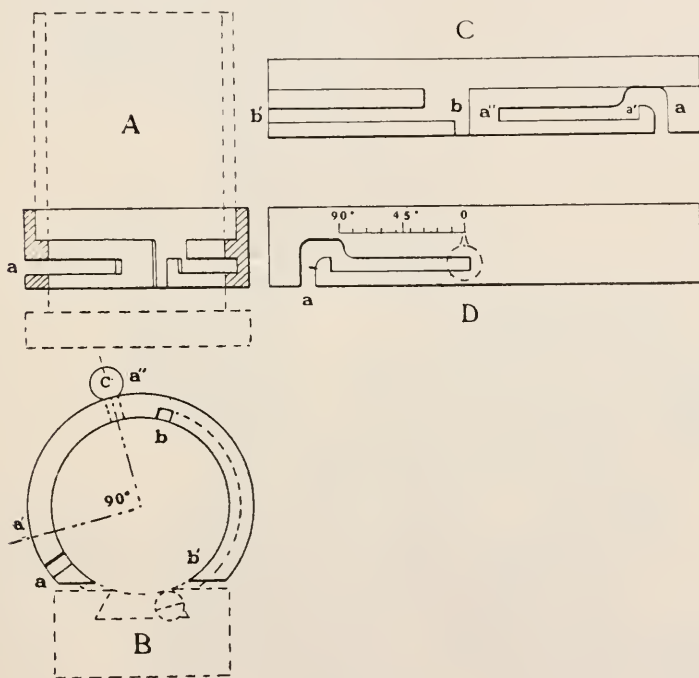

FIG. 83.

quartz gypsum wedge. The thickness of the underlying mica plate is so chosen that it exactly compensates the front end of the quartz wedge, consequently the colours of the combination wedge begin at darkness and gradually increase to the fourth order as the wedge is pushed forward. A spring *S*, attached to the side of the Microscope tube, presses against the carriage and produces enough friction to hold it wherever it is placed. When the opening *b* is centred, the spring drops in a rounded notch as shown. Upon the upper side of the carriage a scale is engraved, and the end of the spring shows the order of the colour at that time beneath the cross hairs of the Microscope.

3. *A rotating lower nicol for observing very slight pleochroism.*—A

brass collar turned to fit the lower part of the nicol tube is soldered on, as shown in fig. 83. A shows a section through the collar, the nicol tube being here indicated by dotted lines; B is a view from below; C a view of the inside of the collar as it would appear if straightened out; and D, the outside of the collar similarly unrolled. A groove is cut on the inside to receive the head of a screw projecting from the side of the nicol tube $b b'$ (B and C). On the opposite side of the tube a lever c moves in the slot $a' a''$ (B), which is of such length that the distance between centres of the lever, in the position $a' a''$, is just 90° . The screw head and the lever bar thus form the bearings to carry the nicol tube. As the lever is moved from a' to a'' , the screw-head b slides in the groove from b to b' . The nicol tube may be removed or inserted easily by slightly raising and rotating the tube until the lever bar passes over the projection at a (D).

4. *Additions to the Hirschwald Stage.*—Fig. 84 shows two scales en-

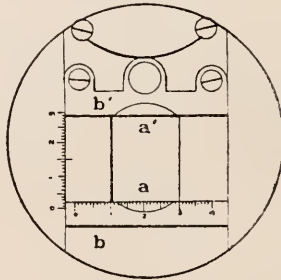

FIG. 84.

graved upon the two parts of the Hirschwald stage. A mark on the sliding portion indicates the distance through which the plate has been moved. Horizontal movement is registered by a small scratch made with a diamond point on the lower margin of the thin section. Any mineral whose position is once registered may again be located by resetting the stage to the former reading. It is necessary to read both the horizontal and the vertical scales.

Watson and Sons' "Royal" Microscope.*—This model has been subjected to revision in several of its structural details, and to enable these to be more clearly understood, illustrations are appended of the principal parts. Reference to the fig. (85) of the Microscope itself will show that it has mechanical movements to stage, a compound substage with screws to centre and rackwork to focus, and a mechanical draw-tube carrying large-sized eye-pieces.

The principal feature in the construction is one which has hitherto prevailed only in this firm's "Van Heurck" instrument. Usually the stage is attached to the lower part of the limb by screwing, but in this instrument a closer and more rigid union is effected. It will be seen by reference to fig. 86 that the limb is continued downwards, so as to form

* Catalogue, 1910-11, pp. 46-9 (3 figs.).

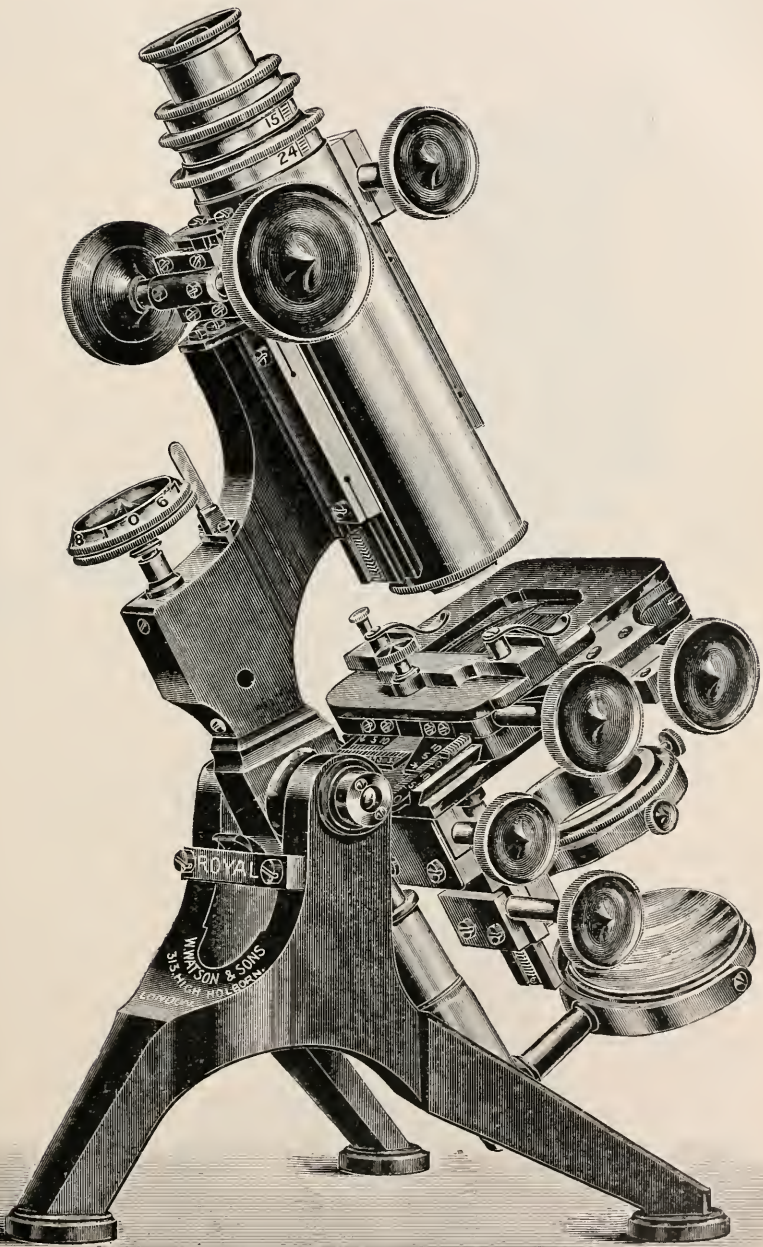

FIG. 85.

an attachment base for the substage, and a shelf and centre for the stage attachment.

The casting of the stage base-plate is continued backwards, so as to

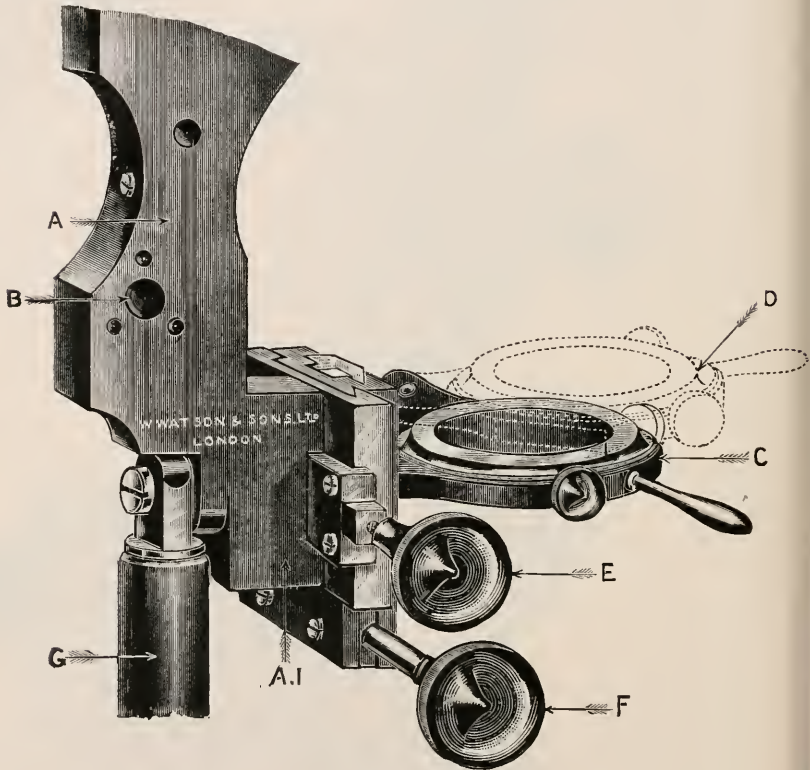

FIG. 86.

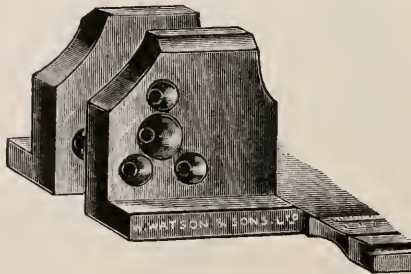

FIG. 87.

form two cheeks (see fig. 87), which embrace either side of the limb. These cheeks are then screwed to the limb, and the axis-bolt, on which the instrument is inclined, passes through the whole.

The substage-fitting is arranged to swing out of the optical axis with the condenser or other apparatus which may be carried in it, and a fine-adjustment is provided to the substage when required.

Quidor-Nachet Microscope.*—The purpose of this instrument is photomicrographic, with especial reference to stereoscopy. The Microscope is described, and has been designed, by A. Quidor. The manufacture is by Nachet. As will be seen from fig. 88 and pl. XII., this instrument differs from the ordinary model by the inclination which the Microscope tube can take to the left and to the right of the vertical, and by the independence of the stage P. An iris-diaphragm placed above the revolver is used with weak objectives, thereby increasing the depth. Inclination is measured by a graduated drum E. A clamp-screw S fixes the apparatus in any desired position. The milled heads F control the rackwork focusing in the usual way. The stage not only has rotatory and rectangular movements, but can also be moved vertically by means of the micrometer-screw L. An index I coincides with a definite point on the stage support when the upper surface of the latter coincides with the axis of rotation. The independence of the stage makes it possible to bring the upper face of the object to the level of this axis, a condition indispensable if the object is to be, and to remain, centred during the angular displacement of the optic axis of the Microscope. The camera is placed above the Microscope-tube, and takes, automatically and successively, on the same plate (8 × 16 cm.) and at two different angles, two views of the same object. The photography is performed with or without the ocular. In fig. 88, AB and A'B' are two successive positions of the frame for taking a stereoscopic cliché. D is the rod carrying the camera. T is a double tube for preventing all infiltration of diffused light; *b* is one of the buttons controlling the rectangular movement; *c* is the axis of rotation. Fig. 88 also shows the arrangement for magnifications less than 8 diameters and for reductions.

The author gives a table of the magnifications obtainable. They may extend to 680 diameters.

The author also explains and enunciates the two following principles which govern the use of his Microscope:—1. For the same inclination of the optic axis the relief given by stereoscopic views of the same object is independent of the magnification. 2. When an object is photographed under an angle of inclination I_1 , its relative relief for a new inclination I_2 is multiplied by the square root of the ratio of the new angle of inclination to the first.

The author adds many practical hints. An aquatic animal should be photographed in water. Small animals between 4 and 40 mm. should be fastened by a drop of gelatin to the bottom of a small dish and then covered with water. The gelatin may be allowed to dry hard, or may be set with a drop of formol. Smaller animals should be fixed with osmic acid and mounted on a slide with formulated water. Animals exceeding 40 mm. should in general be photographed dry. As an illuminant sunlight, when obtainable with a heliostat, is excellent. Nachet's form of the Nernst lamp is the most trustworthy; it can be worked with

* Arch. Zool. Expér. et Gén., v. (1910) p. lxxvii-lxxxii (5 figs.).

an alternating or a continuous current. The author gives several examples of stereoscopic views taken by his apparatus.

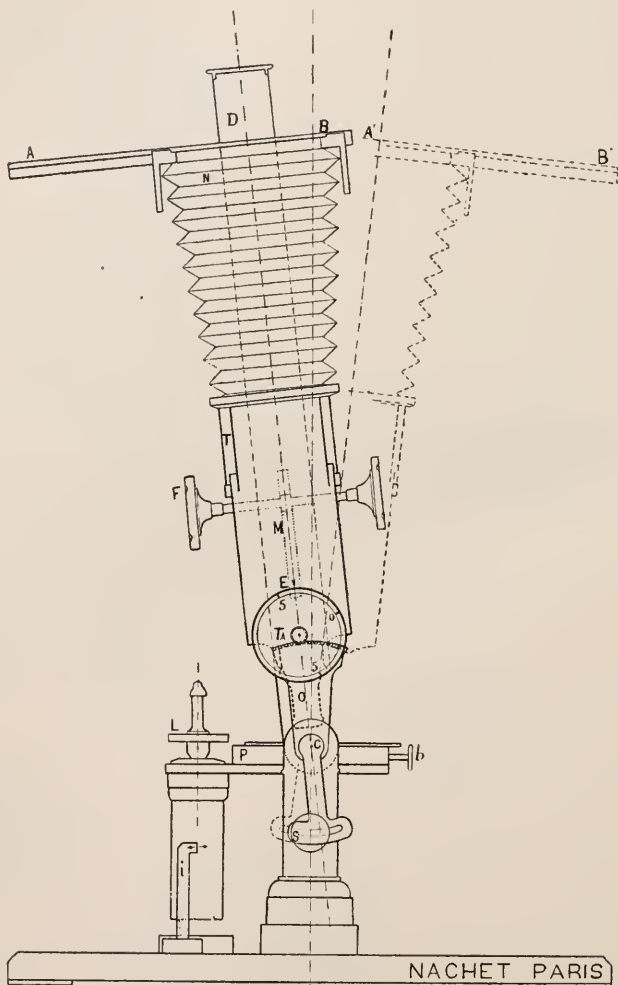

Fig. 88.

BOMAN, H. L.—Objektisch-Goniometer für das Dick-Mikroskop.

Centralbl. f. Mineral., Geolog., u. Paläontog., 1910, p. 187.

LEISS, C.—Verbessertes Kristallisations-Mikroskop mit Erhitzungs und Kühl-
verrichtung für projection. *Zeitschr. f. Kristallograph.*, xlv. (1909) 280 pp.

SOUZA-BRANDAO, V. DE—O novo Microscopio da commissao do Serviço Geo-
logico. *Comunicações do Serviço Geologico de Portugal.*

Lisboa : (1903) v. pp. 118-250.

(2) Eye-pieces and Objectives.

Watson and Sons' Parachromatic Objectives.*—Fig. 89 shows the construction of the low-power objective of this series. The construction of the $\frac{1}{6}$ -in. and $\frac{1}{12}$ -in. has been given.† The working distance of these objectives is greater than usual, for example, the distance between the front lens of the 1-in. and $\frac{2}{3}$ -in. objectives and the object is about the same as their focal length, and the $\frac{1}{6}$ -in. has a working distance of more than 1 mm. This working distance permits the $\frac{1}{6}$ -in. objective to be used in connexion with the hæmocytometer, a great boon for clinical laboratory work, as those who are given to blood counting know. The immersion objective has been specially designed and entirely re-computed for laboratory work, and is particularly adapted for the examination of stained specimens.

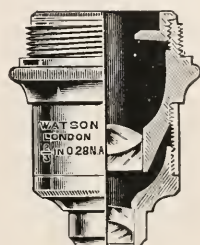

FIG. 89.

(3) Illuminating and other Apparatus.

Drawing with the Camera-lucida.‡—F. Brocher discusses the causes of eye-fatigue frequently experienced in the use of the camera-lucida. He shows that the cause lies in the difficulty of seeing at the

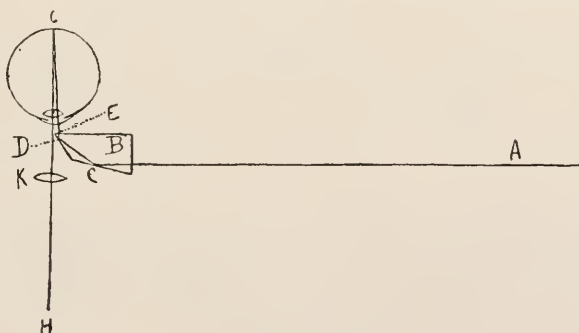

FIG. 90.

same time two objects at different optical distances. Thus if the object to be drawn is at A, at a distance of 1 m., and the paper and pencil are at H, at a distance of 30 cm. (fig. 90), the eye has to exert two different degrees of accommodation. To see A distinctly the surface of the crystalline lens must modify its curvature by one dioptrie, while to see H it must modify it by 3.33 dioptries. It is impossible that the crystalline lens can exert these two different radii of curvature at the same time. Hence the sense of eye-fatigue. If A is to be seen distinctly,

* Catalogue, 1910-11, pp. 86-9 (3 figs.).

† See this Journal, ante, p. 226.

‡ Bull. Soc. Zool. de Genève, 1908, pp. 105-14 (7 figs.).

then H will be invisible, and vice-versâ. The remedy is to bring both A and H to the same optical distance from the eye, and this may be done by inserting a convergent lens of 2.33 dioptries (i.e., $3.33 - 1.0$) between the eye and the paper. The author discusses many of the possible cases, and gives tables of the lenses required under various circumstances.

New Nicol for Projection Purposes.*—W. von Ignatowsky points out that for the projection of crystalloptic examination it is usually necessary to have a parallel beam of polarized light, and that the diameter of this beam must be as great as possible. The polarization of the beam is effected in two ways, either by bringing the polarizer directly into the beam, or into the place where the image of the light-source is formed. In the latter case, it is necessary to apply a lens behind the polarizer (in the sense of the light-course) in order to parallelize the beam. This is, indeed, the method usually adopted, because it requires a smaller nicol. In the former case, the free aperture of the nicol must be very great,

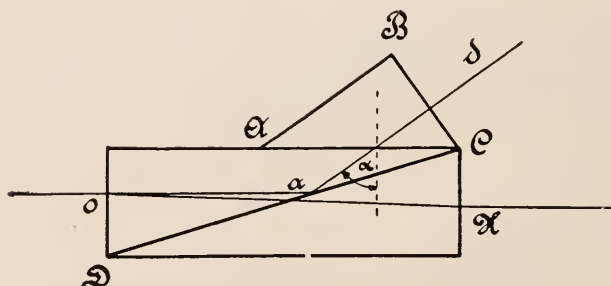

Fig. 91.

and the method is, owing to the high price of calcite, expensive. But both methods have the following disadvantage. As 50 p.c. of the incident radiation remains behind at the nicol, the nicol itself becomes so heated within a very short time that the cement layer is injured, and the nicol is useless for further investigation.

The author describes a method by which the above inconvenience is avoided in a very simple way; it even allows an hour's projection with arc lamp and a current up to 30 amperes without the least injury to the nicol. The cause of the heating lies, doubtless, in the absorptive properties of the black layer which reflects the ordinary ray. It therefore becomes necessary to avoid this cause. Fig. 91, representing a nicol with perpendicular end-planes, shows how the author gets over the difficulty. The extraordinary ray oX goes right through the nicol, and the ordinary ray oa is reflected at the cement layer DC . The plane AC of the nicol is polished. But as the angle α is greater than the angle of total reflexion, a glass prism ABC is cemented on, thereby permitting the free exit of the ordinary ray oal out of the nicol. In the applica-

* Zeitschr. f. Instrumentenk., xxx. (1910) pp. 217-18 (1 fig.).

tion, for example, of a Glans prism (involving an air-layer) it is of great advantage to avoid heating, because the cement is apt to fly into the air-layer. In such a case a lateral plane should be polished on to the nicol; the glass prism is not necessary because the angle α is less than the angle of total reflexion.

Allotropic Conversion of Phosphorus in the Cardioid-Ultramicroscope.*—H. Siedentopf describes how the actual conversion of white phosphorus into its allotropic, red phosphorus, can be watched. For this purpose it is necessary to introduce a small piece of the white variety into the quartz-chamber of the cardioid-ultramicroscope and to use a magnification of 1500 diameters. The agent of conversion is the light of the visible spectrum. The long-waved rays are kept off by long water chambers and the short-waved are absorbed through the glass of the illuminating lenses. The sharply defined circular field of the cardioid-condenser is controlled by the image of the illuminating lens projected through the condenser and only a very small field at first obtained. An arc-lamp is the light-source. Almost immediately after the admission of light into parts which were previously optically empty, there appear white sub-microscopic specks at a distance apart of perhaps half a micron. The brightness of these specks (? luminiscence) increases rapidly, so that further observation on account of excessive brightness is impossible. If a cobalt glass disk, which cuts off the yellow rays and transmits the red and blue, be laid on the ocular, the change can be further followed and the complete conversion into red seen. The first step in this conversion seems to be a colloidal phase. Before using the cobalt glass place a matt disk immediately under the condenser. Gradually larger and less approximate particles make their appearance. They continue to increase in brightness, but are no longer round; they emit whitish prolongations, partly rectilinear, partly slightly curved, on three or more sides. These prolongations are unpolarized, so that nothing can be said as to a possible crystalline nature. If the matt disk be now removed and strong light allowed to enter freely, these particles with their prolongations develop in a few seconds an intensive light-emission; with the cobalt-glass disk their red tint may be recognized. More central particles and prolongations reveal themselves, and gradually the whole field is filled with the gleam of a reddish meshwork. This new state of the phosphorus remains permanent in darkness. Similar demonstrations may be made successively of different parts of the field.

If solution of phosphorus in carbon disulphide be used, instead of pure phosphorus, the effects are similar. There is, however, also an earlier phase. If the light be darted, lightning-like, into areas which were previously optically empty, white sub-microns are seen in active molecular movement; but they are quickly absorbed, and remain clinging to the walls of the quartz-chamber. In gold solutions this molecular movement may last three days before absorption. The author has experimented with arsenic and selenium with a similar series of results. He has also observed the reduction of potassium bichromate, which under the influence of light takes place in a few seconds.

* Ber. Deutsch. Chem. Gesell., xxxiii. (1910) pp. 692-4.

Recent Progress in Ultramicroscopy.*—Under this title H. Siedentopf describes the cardioid condenser and many of its results. He also discusses various technical difficulties in the application of the apparatus. These have already been noticed in our pages. He draws attention, however, to a new and convenient form of special chamber,† which is illustrated in fig. 92. A small circular quartz plate of about 2 cm. diameter and 1.2 mm. thick is provided on its upper face with a circular groove. The area within this groove forms a sort of plinth and is polished down about $1-2 \mu$ deeper than the peripheral ring. If now a dust-free cover-glass of uniform thickness is laid on this external ring there is a formation of Newton's colours, but an air-layer of $1-2 \mu$ in thickness is superposed above the plinth. If a small drop of any fluid had been previously introduced by means of a platinum loop, the liquid would have spread itself out and any excess would have found its way into the circular groove. In this way the operator can easily obtain a fluid layer of $1-2 \mu$ thick. It is found that ordinary cover-glasses of

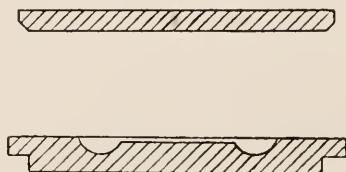

FIG. 92.

0.16 mm., as generally used, are unsuitable. They reveal curvature and exhibit a tendency to cleave to the plinth, with the effect of squeezing out the fluid. It is necessary to use stouter cover-glasses of $\frac{3}{4}$ mm. thickness.

Interferometer, with Inverse Superposed Luminous Rays, giving in White Polarized Light a Narrow Central Fringe of Sensible Tint and Narrow Coloured Fringes at White Intervals.‡—G. Sagnac describes (fig. 93) an interferential apparatus, by means of which he combines rays differing by small velocities of propagation.

Two isosceles triangular prisms, P_1, P_2 , cut out of the same piece of glass ($n = 1.514$ for the radiation $\lambda_s = 0.56 \mu$), with angles α identical to a few seconds, are placed with their faces, ll' , very close together so that a rhombic prism is formed. The layer of air, ll' , acts as a transparent silvered surface. Hence the light issuing from the collimator C divides at the air-layer into transmitted vibrations (relative amplitude T) and reflected vibrations (relative amplitude R), which are propagated in opposite directions along the same triangular circuit $I M_1 M_2$. The lens L receives together the vibration T, a second time transmitted by the air-layer (amplitude T_2) and the vibrations R, a second time reflected by the same layer (amplitude R_2). A polarizer, not represented

* Ver. Deutsch. Phys. Gesell., xii. (1910) pp. 1-42 (many figs.).

† Tom. cit., p. 13.

‡ Comptes Rendus. cl. (1910) pp. 1676-9 (1 fig.).

(4) Photomicrography.

Practical Photomicrography.*—Fig. 94 shows a simple and very inexpensive apparatus which J. Jullien has found very satisfactory, and which any deft amateur can adapt to his Microscope. The apparatus is essentially composed of a rectangular wooden box of exterior dimensions $27 \times 27 \times 62$ cm. One of the larger sides forms the door, accurately closing by means of two pins. The bottom is pierced with a round hole 12 cm. in diameter, to which is fastened a sleeve of black stuff, supple and light-tight. The Microscope tube fits into this sleeve and is secured by a running string. The interior of the box is completely varnished in

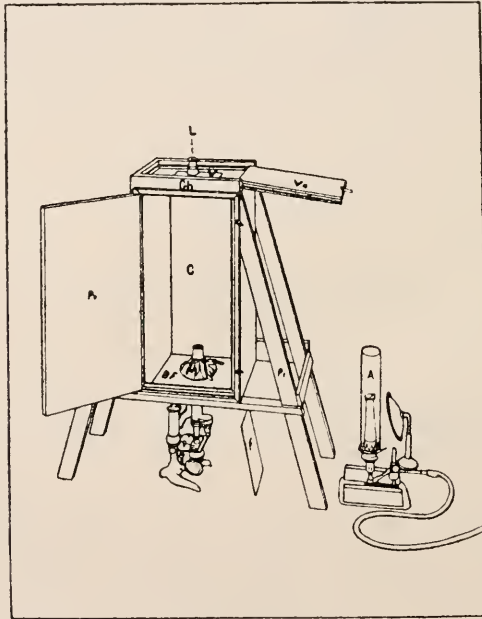

FIG. 94.

dull black. Any ordinary strong double shutter can be used—with a certain modification, however, viz. that the dividing partition is to be done away with, and the ground glass put in exactly the place which the sensitive plate will afterwards occupy. In this manner any difficulty as to difference of focus between the surface of the matt-glass and the sensitive plate will be avoided. The light-source (gas, incandescent lamp) is set about 40 cm. from the Microscope mirror, and a monochromatic filter is placed between the light-source and the mirror.

As an economical method of making a monochromatic filter, the author recommends an unexposed sensitive plate which should be first fixed in hyposulphite and washed as a negative. It should afterwards

* Bull. Soc. Zool. de Genève, 1908, pp. 101-4 (1 fig.).

be immersed some minutes in a solution of 70 p.c. alcohol 200 c.cm., Mars' yellow (aniline) 1 grm. When the plate has been dried in a dustless atmosphere it will be found to have a tint approaching the ideal yellow. Other aniline colours after comparative trials with the spectroscope will give by this process excellent screens of other tints.

(5) Microscopical Optics and Manipulation.

Behaviour of Crystals in Light Parallel to an Optic Axis.*—

If a section of a biaxial crystal be cut normal to an optic axis, and this section be examined in parallel light between crossed nicols, it appears uniformly bright in all positions when rotated about the axis. C. Travis points out that this phenomenon is commonly ascribed to interior conical refraction; but he considers that, owing to the neglect of certain important factors, this conclusion is untenable. The object of his paper is, therefore, to present a discussion of the behaviour of crystals in light that is approximately parallel to an optic axis, and to explain the observed differences between uniaxial and biaxial crystals under these conditions. His conclusions are: 1. That interior conical refraction, in a strict sense, plays no part whatever as a cause of the phenomenon. 2. That the cause is to be found in the fact that so-called parallel light has commonly a considerable divergence. 3. In any given case, the observed intensity of illumination is equal to the average intensity of that portion of the interference figure bounded by the limits of the pencil of light used. The general configuration of the interference figure is dependent upon the optical constants of the crystal, and upon the thickness of section; these, as well as the amount of divergence of the light, are the determining factors. 4. That the reason why the same phenomenon is not commonly observed in uniaxial crystals is that in the uniaxial figure the first bright ring about the axis is in general much larger than that in the biaxial figure. Under proper conditions, however, the phenomenon may be also shown by a uniaxial crystal.

In the course of his paper he gives the demonstration illustrated in figs. 95 and 96. A ray SA (fig. 95), from a source S, is divided upon entering a biaxial crystal, into the rays AB and AC, which vibrate at right angles. From the same source another ray, SD, may be found which will divide into DC and DE; C is then the common point of emergence of one ray from each of the points A and D. These rays are polarized at right angles. If the crystal is between crossed nicols, interference takes place between the components of AC and AD parallel to the plane of the upper nicol. The effect produced is dependent upon the difference in phase at C, and this is due to the difference in the optical length of the paths SAC and SDC. If the wave-front of the two rays is essentially normal to the optic axis, it can be shown that the path SAC (SA being great) is optically equivalent to SDC. If, then, S is at a great distance the two rays at C will be in phase; their vibrations will give a resultant which is parallel to the plane of the lower nicol, and this resultant will be extinguished by the upper nicol.

* Amer. Journ. Sci., xxix. (1910) pp. 427-34 (2 figs.).

In fig. 96 the source is supposed to be at a finite distance and the section normal to the axis. The maximum phase-difference is that between the two rays that lie in the plane of the optic axes; in the figure, this plane is taken as the plane of the paper. It can be shown that the phase-difference at the point of interference is constant if the rays are so nearly parallel to the axis that their front velocity in the crystal may be considered constant. When the section is not cut normal to the optic axis (as in fig. 95) the same result holds if the thickness parallel to the axis be considered instead of the section thickness. From certain experimental data the author concludes that the behaviour of the crystal in light that is approximately parallel to an optic axis, must

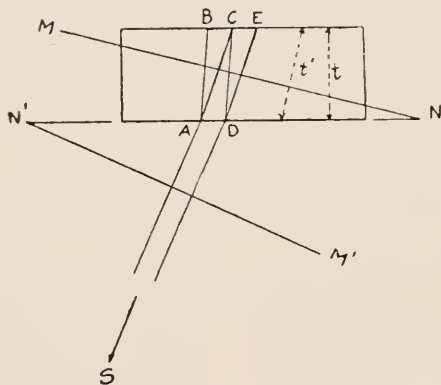

FIG. 95.

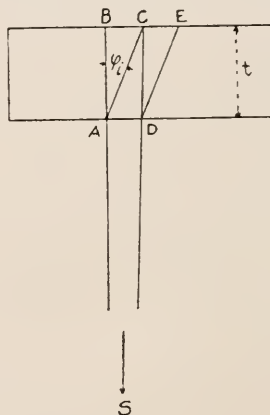

FIG. 96.

be referred to interference effects of exactly the same nature as those observed in any general section with the light falling at any inclination to the axis.

Axial Images of Fluid Crystals.*—D. Vorländer and H. Handswaldt have published the results of their investigations on the above subject. These results are illustrated by 19 plates containing about 80 beautiful photographs of interference figures which have been all obtained by examination with polarized light of thin layers of certain fluids. These figures seem a proof of the crystalline composition of fluids, and they suggest an insight into the structure of fluids and of molecules. They are met with not only in simple forms, but in complicated designs identical with those of solid crystals. At present, however, only uniaxial varieties have been detected.

Ultramicroscopic Examination of Liquids during Electrolysis.† J. J. Kossogonoff (of the University of Kieff) has thought of using the ultramicroscope invented by Siedentopf and Zsigmondy for the investigation of the phenomena of electrolysis, with extremely good

* Abhand. der Kais. Leopold-Carolin, Deutsch. Akad. der Naturf., xc. pp. 105-17 (19 pls.).

† Athenæum (1910) ii. p. 73.

results. According to the *Revue Générale des Sciences* for June 15, in which a well-illustrated account of his experiments appears, on focusing the instrument on the electrolyte when no current is passing, the observer sees many luminous points which appear to be executing the Brownian movements. On the closing of the circuit, these luminous points string themselves out into a chain, which progresses towards the negative electrode; and on reversing the current, the direction of the stream is also reversed. Kossogonoff does not go so far as to assert that these luminous points are the actual ions, although he shows, by reference to certain calculations of Kohlrausch, that they probably have about the same velocity; but he suggests that, if they are not the ions themselves, they are at least groups of ions, and this may be provisionally accepted. A control experiment, in which the stream of luminous points was exposed to a magnetic field at right angles to its normal direction, seemed to show a dark place near the cathode such as occurs in a Geissler tube in similar circumstances, followed by a layer in which the luminous points are extremely numerous; and the use of sulphate of copper as the electrolyte is said to produce some very beautiful effects. This method of investigation seems capable of extension, and should produce further notable results.

ZSCHOKKE, W.—*Ansauliche Darstellung der Entstehung und Hebung der sphärischen und astigmatischen Bilder.*

Deutsche Mechan. Zeit., Heft 9, 10 (1910) pp. 81-7, 93-7 (17 figs.).

(6) Miscellaneous.

Diagnosis of Natural and Artificial Silks.*—A. Herzog's monograph is a practical introduction to the methods for determining the nature of fabrics, known to the textile trade as silk, by microscopical and chemical means. The booklet is divided into four parts, which deal respectively with the microscopical examination of the fibres; chemical tests, in which are included the most important micro- and macro-chemical reactions; optical examination, which deals with the behaviour of the fibres to polarized light and with refrangibility; while the fourth part is concerned with their ultra-microscopic appearances. Two useful tables are given, one for determining the nature of silks by optical means, the other by microscopico-chemical procedure.

B. Technique.†

(1) Collecting Objects, including Culture Processes.

Observations on a New Gregarine, *Metamera schubergi* g. et sp. n.‡—H. L. Duke obtained his material, *Glossosiphonia complanata* Linn., a leech which serves as host to *Metamera schubergi*, from water in the neighbourhood of Heidelberg. The leeches can be kept for an in-

* Dresden: Theodore Steinkopff (1910) 78 pp. (50 figs.).

† This subdivision contains (1) Collecting Objects, including Culture Processes; (2) Preparing Objects; (3) Cutting, including Imbedding and Microtomes; (4) Staining and Injecting; (5) Mounting, including slides, preservative fluids, etc.; (6) Miscellaneous.

‡ *Quart. Journ. Micr. Sci.*, lv. (1910) pp. 261-86 (2 pls.).

definite time in water, provided it be constantly aerated; food is not necessary, though water-snails are appreciated. Owing to the transparent integument, the parasites are visible in the living leech, and may be observed in the stomach diverticula and intestine; the cysts are found in the same situation, but are especially numerous in the intestine.

The Gregarines were obtained by making two incisions parallel to the margins of the leech, and one at right angles to the long axis at about the junction of the middle and anterior thirds. The gut contents were then emptied into normal saline, from which the Gregarines were pipetted on to slides for examination. Preparations in toto were made under a cover-slip supported on wax feet, the various reagents being drawn through with blotting-paper. The stains used were Grenacher's alcoholic carmin solution and Schuberg's modification of Mayer's acid carmin. Leeches destined for sections were fixed in Gilson's fluid. As stains, Delafield's hæmatoxylin with eosin, safranin, and Heidenhain's iron-hæmatoxylin were employed. To obtain the ripe spores, the cysts were placed in a moist chamber, where the spores developed in 7 or 8 days. The cysts were either placed on a slide in a drop of Neckar water, or under a coverslip supported on wax feet.

Observations on a Flagellate of the Genus *Cercomonas*.*—C. M. Wenyon describes a Flagellate of the genus *Cercomonas*, which was found in the fæces of a patient infected with *Entamoeba coli*. Cultivations were made in hay infusion to which a small quantity of fæces was added. Agar used for the culture of amœbæ was also most useful. A film of this medium was placed in a well formed by means of Czokor's wax, arranged in ridges about $\frac{1}{8}$ in. high. The medium was inoculated with material from a previous culture and a long cover-glass ($1\frac{1}{2}$ in.) placed on the well. By means of a hot wire and more wax the well is sealed up. In this way the multiplication of the Flagellates is easily followed with a $\frac{1}{8}$ -in. objective, and if the film of the medium be sufficiently thin with a $\frac{1}{12}$ -in.

For studying the Flagellates in the fixed and stained condition the cover-glass method was mostly used. The best fixative was two-thirds sublimate and one-third alcohol slightly acidified with acetic acid. Iron-hæmatoxylin was the best stain.

Simple Anaerobic Method.†—For this method, described by Crendiropoulo, the only apparatus required consists of culture tubes, small wide-necked flasks, and a hydrogen apparatus. Agar slopes are inoculated by Veillon's method. The platinum loop is introduced into the condensation water and withdrawn carefully, so as not to touch the surface of the medium. The tube is then inclined so as to distribute the inoculated condensation water over the surface of the medium. Then a half-turn allows the water to trickle back to the bottom of the tube. Then, by means of a capillary pipette, the water is drawn off as completely as possible. The cotton-wool plug is flamed and pushed down the tube to within a few millimetres of the top of the agar slope. A tube from the hydrogen apparatus is introduced into the open end of the

* Quart. Journ. Micr. Sci., lv. (1910) pp. 241-60 (19 figs.).

† Centralbl. Bakt., 1^{te} Abt. Orig., lv. (1910) pp. 247-8.

culture tube, which is now reversed and introduced into a wide-necked flask half-full of a concentrated pyrogallic acid solution. The surface of the pyrogallic is covered with a layer of oil which, while it permits the escape of superfluous gas, prevents access of air. After a few moments the hydrogen has displaced most of the air. The hydrogen tube is now withdrawn, and, by means of a pipette, concentrated caustic soda is added to the pyrogallic acid. Any remaining oxygen is thus absorbed.

Collecting Living Foraminifera.*—E. Heron-Allen and A. Earland point out that living Foraminifera are easy to obtain and no harder to preserve alive than other Microzoa: they give the result of their experience based on more than twenty years' collecting. The apparatus required is of the simplest description: a pail, a coarse sieve with meshes $\frac{1}{8}$ in. in diameter, and a jar or tank in which to preserve the specimens when caught. The horsehair sieves used by cooks are best as they do not corrode, but a metal sieve will do if it is carefully washed and dried after use. The writers use an enamel pail with a diaphragm of galvanized iron wire net. If preferred a second sieve of fine bolting silk may be substituted for the pail, and this is the method recommended and used by J. J. Lister, but the writers use a pail for the collecting, as it retains the diatoms and other microscopic organisms on which the Foraminifera feed, the bulk of which pass readily through the meshes of a silk sieve.

Foraminifera are to be found in abundance in the shore-sands of nearly every coast. To obtain living specimens in any numbers without the use of a dredge we must have recourse to a shore on which rock pools or weed-grown patches can be found between tide marks, although a certain abundance can be obtained on any muddy foreshore. The pail should be half filled with sea water and the sieve rested in it so that the upper rim is not submerged. A handful of small weed, coral-line or confervoid preferably, is then torn off, placed in the sieve and thoroughly rinsed with an up and down motion of the sieve in the water. All the small organisms, Foraminifera, Copepoda, and so on, and most of the fine mud and diatoms adherent to the weed will pass through the meshes into the pail. The process is repeated until a sufficient quantity of debris has accumulated in the pail.

For the preservation for observation of the living Foraminifera a suitable tank or aquarium must be prepared. The bottom of the tank must be covered with pebbles or small fragments of rock, on which green seaweed, *Ulva* or *Cladophora*, is in active growth. The tank is then three-parts filled with sea-water and the muddy debris poured in, the surplus water being first syphoned out of the pail after the mud has settled. The mud will settle down in the aquarium and fill up the interstices between the stones. The object of the weed is to oxygenate the sea-water, a method far preferable to the syringing usually recommended, as it can be regulated by the amount of light which is allowed to reach the tank. Moreover, when the weed is in active growth it supplies the Foraminifera with food in the shape of motile zoospores.

Before the muddy debris is placed in the aquarium it is well to empty

* Knowledge, xxxiii. (1910) pp. 235-6.

it into a shallow dish, and remove any undesirable objects, such as worms, large Crustacea, or large fragments of weed, which may have been washed out of the sieve. These would otherwise rot, and set up putrefaction in the water before the aquarium is properly in going order. Once the tank is well started, Nature can generally be trusted to keep the balance of life and death pretty equal, for the presence of a certain proportion of Monads and Infusoria in the water, due to and living on the decay of organisms which have died, seems to be beneficial rather than otherwise to the Foraminifera, serving them as food. If these Microzoa appear to increase too rapidly, which can be seen with the Microscope, or tested by the sense of smell, they can be checked or stopped by increasing the oxygenation of the tank, which is effected by exposing it for a short time to the direct influence of sunlight.

The natural evaporation from the surface of the aquarium would rapidly render the water too saline for life, and this must be remedied by the addition of the necessary quantity of fresh-water as required. The easiest method of preserving the water at its correct salinity is to place a pair of glass specific gravity bulbs in the tank. These can be obtained at a very moderate cost from the dealers in chemical apparatus. They are obtainable in pairs, clear glass and blue glass. The blue bulb sinks to the bottom in normal sea-water, gradually rising as the salinity increases owing to evaporation. The clear glass bulb floats in normal sea-water and sinks if the specific gravity is reduced by the introduction of too much fresh-water. The bulbs require a certain amount of care in their use, as the attachment of any organism to the clear bulb will cause it to sink to the bottom, while the blue bulb often rises under the buoyancy of a bubble of oxygen derived from the weed. It is well, therefore, to examine the bulbs before adding fresh water at random, and the latter must be introduced a few drops at a time and left for some minutes to mix with that in the tank.

When the muddy debris is added to the tank, for many hours, or sometimes days afterwards, few, if any, signs of Foraminifera will be seen. They are all buried under the thin semi-liquid mud. But they will gradually emerge and make their way towards the glass, up which they slowly crawl by means of their pseudopodia, which can be seen surrounding them in an opalescent halo if the tank be examined by oblique light. In the course of a few days the glass sides will be seen to be thickly studded with the tiny shells, prominent among which, owing to its comparatively large size and great abundance, will be the handsome Miliolid, *Massilina secans* d'Orbigny. Any specially interesting species may be removed by means of a pipette to a smaller tank for observation.

For the purpose of examination there is nothing finer than the Greenhow-Smith model of tank Microscope, made by Zeiss. With it specimens can be examined in the tank under a comparatively high power. But the strong light of a Nernst lamp is required to do justice to it, although with the lower powers good results can be obtained with an ordinary Microscope lamp and bullseye condenser. The best results are obtainable with direct light, as the thickness of the tank militates against the use of transmitted light.

For those who have to rely upon the ordinary Microscope and for any work with high powers, the living "foram" must be removed to a cell or excavated slip. After the specimen has been located on the glass side of the aquarium it must be detached with a needle or fine brush with one hand, and as it falls down the side of the tank must be caught with a pipette held in the other. Foraminifera are very sensitive to vibration or shock, and draw in their pseudopodia rapidly, but in most instances they will quickly recover when placed on the stage of the Microscope, and again protrude them. The first sight of a fine *Polystomella* or *Massilina*, with its pseudopodia fully extended, is indeed an experience never to be forgotten.

New Method of Preparing Culture Media.*—C. Gessard is of opinion that the repeated sterilizations required in the preparation of ordinary media, must cause alterations in the constituents, which are undesirable for some purposes. He has, therefore, made use of a method of preparing media without using heat. Three parts of blood, drawn from a vein under aseptic conditions, are received into a vessel containing 1 part of a 20 p.c. salt solution. The strong saline inhibits the process of clotting, but if the mixture be diluted with nine times its volume of water, a clot is formed. Suitable quantities of the concentrated saline mixture are introduced into test tubes, and diluted with sterile distilled water. The tubes are sloped if desired. A clot soon forms, which constitutes the culture medium. As all the manipulations have been conducted so as to avoid contamination, no further sterilization is necessary. The medium may be modified by the addition of sugars, glycerin, or other materials.

Isolation of Cholera Vibrios.†—Finding the stereotyped peptone-water method unsatisfactory for separating the vibrio from *Bacillus pyocyaneus* and certain other organisms, M. Crendiropoulo and A. Panayotatou have discovered a medium upon which these extraneous organisms are more effectively inhibited. A solution of peptone—Witte's for preference—is made alkaline by the addition of soda, so that its reaction is between 0.28 and 0.4 p.c., expressed in terms of soda. When the medium is required for use, 2 parts of this solution are added to 3 parts of neutral peptone agar. The mixture is poured into Petri dishes, and allowed to set. It may then be spread with an emulsion of the suspected material.

The authors also made trial of Dieudonne's alkaline hæmo-agar, but found that the latter did not always restrain *B. pyocyaneus*. Moreover, the colour of this medium made it difficult, in some cases, to distinguish the colonies of the two organisms.

MULLER, A.—Über den Einfluss des Gehalts der Gelatine an schwefeliger Säure auf ihre Verwendbarkeit in der bakteriologischen Technik.
Arb. Kaiserl. Gesund., xxxiv. (1910) pp. 164-5.

* C.R. Soc. Biol. Paris, lxxviii. (1910) pp. 1049-50.

† Centraibl. Bakt. 1^{te} Abt. Orig., lv. (1910) pp. 248-250.

(2) Preparing Objects.

Studying Structure and Life-history of *Crithidia melophagia*.*
Annie Porter examined numerous specimens of *Melophagus ovinus*, in which she found the Flagellate parasite *Crithidia melophagia*. The host, known as the "ked," belongs to the Diptera (Hippoboscidae), possessing extremely reduced wings; the keds were obtained from English southern counties. For observations on the living organism two methods of procedure were followed. The alimentary canal was isolated and divided into separate portions; these were either teased out with needles and examined in saline, or the contents were squeezed out and also examined in saline. Alkaline methylen-blue and neutral-red were occasionally used as intra-vitam stains.

For fresh preparations used in work on hereditary infection, the ovaries and gut were dissected out and mounted in saline. The behaviour of the *Crithidia* and the manner in which they passed out of the gut were carefully watched. In investigations of the stages of *C. melophagia* in the egg and puparia, smear preparations were found to be preferable to sections. The method adopted was to prick the egg or open the young puparian and express the contents on to a slide. The contents were at once fixed, then allowed to flow over the slide; this procedure obviated distortion and rupture of the parasites. As these preparations contained much fatty matter, the slides were treated with ether, and after washing with absolute alcohol were stained and mounted in the usual manner.

For making permanent preparations the alimentary tract of the Dipteran host was removed and divided into portions, which usually were teased and fixed wet. The vapour of formalin or of osmic acid was mostly used for fixation, but sublimate-acetic-alcohol and Bouin's fluid were also employed. The stains used were Giemsa, thionin, iron-hæmatoxylin, and gentian-violet with Delafield's hæmatoxylin; the last was particularly useful for the membrane and flagella. Preparations mounted in neutral Canada balsam were superior to dry films or to films mounted in any other manner.

Demonstrating Muscle-spindles.†—P. A. Cilimbaris investigated the muscles of the human eye chiefly, and also those of lower animals; in the latter case the results were for the most part negative. Frozen sections of fresh muscle were overstained with hæmalum and differentiated with hydrochloric-acid-alcohol, washed in tap-water, and mounted either in levulose syrup or in balsam. This method was excellent for the sarcoplasm and the interstitial substance; the contractile elements, however, were unstained.

The fixative used was 10 p.c. formalin, and frozen sections only were used.

Maceration preparations were made by Sihler's method: the muscles were placed in a mixture of 1 vol. acetic acid, 1 vol. glycerin and 6 vol. 1 p.c. aqueous solution chloral hydrate, then for weeks to months in a mixture of 1 vol. Ehrlich's hæmatoxylin, 1 vol. glycerin and 6 vol.

* Quart. Journ. Micr. Sci., lv. (1910) pp. 189-224 (2 pls. and 15 text figs.).

† Arch. Mikroskop. Anat. u. Entwickl., lxxv. (1910).

1 p.c. aqueous solution of chloral hydrate; the teased-out preparations were mounted in glycerin.

Vital methylen-blue staining gave excellent results. The animal (sheep) was washed out through a carotid artery with warm saline or Ringer's fluid. Warm 1 p.c. methylen-blue solution was then injected. The fluid was allowed to set for 20 minutes and then the eyeball-muscles were removed. The muscles were stretched out on a plate and exposed to light in a moist chamber for $\frac{1}{4}$ to 2 hours. The stain was fixed in 10 p.c. aqueous solution of ammonium molybdate for 24 hours. They were then washed in distilled water for several hours, after which they were dehydrated rapidly in alcohol, cleared up in xylol and mounted in balsam.

The methods of Ramon y Cajal and of Bielschowsky were also tried; the results were about the same, but not so satisfactory as those already given.

The materials fixed in formalin were imbedded in celloidin, paraffin, or paraffin-celloidin, and the sections stained with hæmalum, iron-hæmatoxylin, and counter-stained with picro-fuchsin or with one of the numerous preparations of carmin.

(3) Cutting, including Imbedding and Microtomes.

Flatters and Garnett's "Firmax" Microtome.*—This instrument (fig. 97) has been designed in order to meet the demand for a low-priced efficient microtome. It is substantially made with thick brass knife-plate and special arrangements for preventing the wax from turning round. It is provided with table-clamp and thickness register.

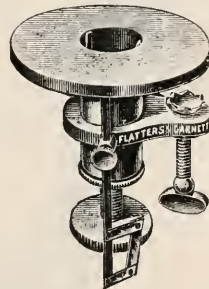

FIG. 97.

Van der Stad's Improved Rocking-microtome.†—The description of this instrument is due to J. Boeke. Fig. 98 gives the general view, which, it will be noticed, differs from the standard type of rocking-microtome rather in elegance and stability than in essentials. The author includes the following among his improvements.

1. One of the four feet of the heavy base-plate A is shorter than the other three, and serves for the reception of a position-screw (*a*, figs. 98 and 102).

2. The instrument can, at desire, be arranged (fig. 99 RMI) for section-thicknesses from 0–25 μ , proceeding by 1 μ ; or for section-thicknesses (RMII) from 0–20 μ , proceeding by 0.5 μ .

3. The object-holder (figs. 98, 100, 101) has some special advantages, in addition to the ordinary movements, in three mutually perpendicular planes for setting the object with any desired orientation. The upper part (figs. 98 and 100) of the holder consists of a strong angle-piece *c*, the shorter side of which carries a strong flattened rounded plug, which

* Catalogue B, 1910, p. 33.

† Zeitschr. wiss. Mikrosk., xxvi. (1909) pp. 242–55 (6 figs.).

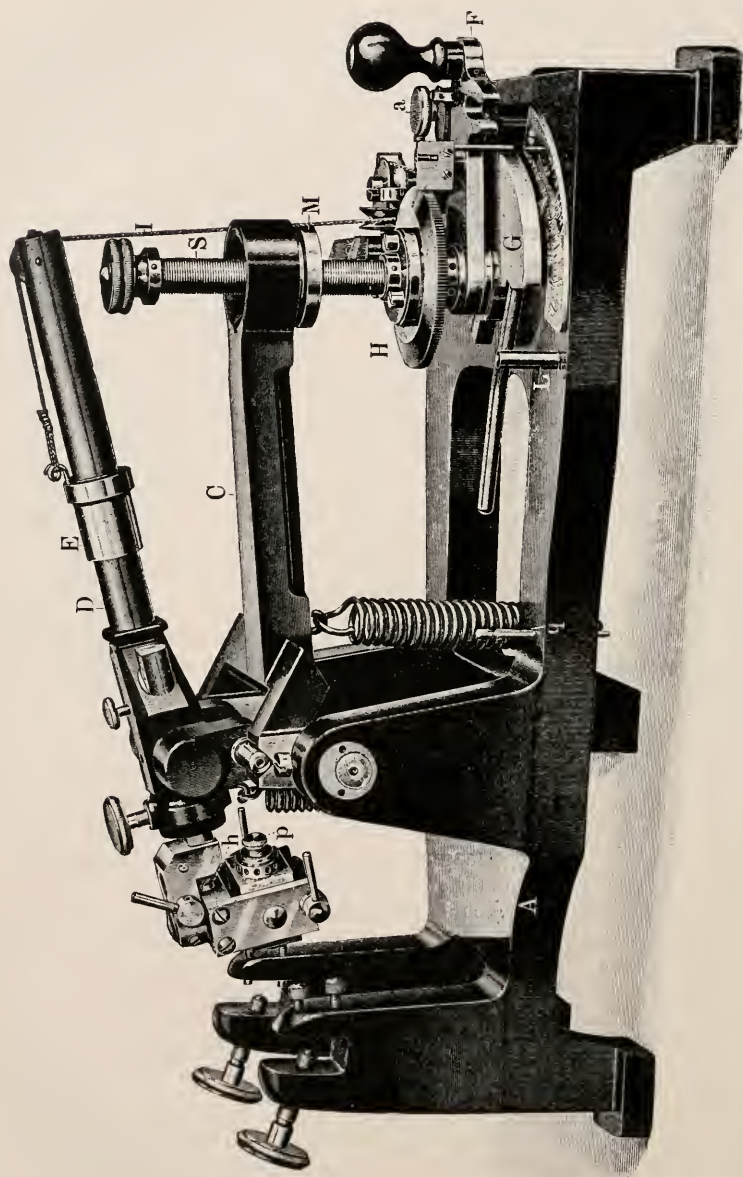

FIG. 98.

fits into a corresponding perforation in the rocking-lever *D*, and can be securely fixed by two milled-headed screws. To the underside of the angle-piece is applied a four-sided prism *d*, carrying on each of two

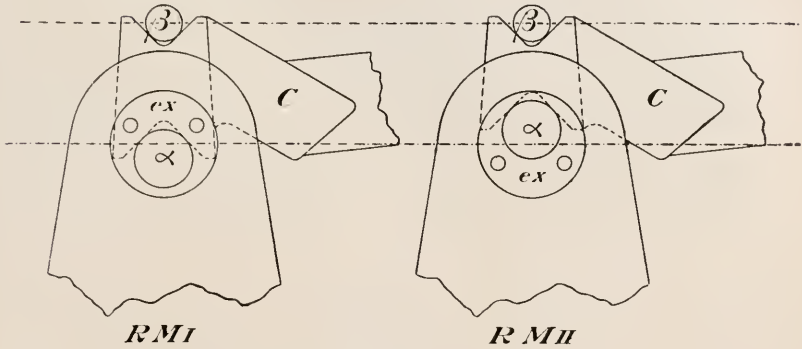

Fig. 99.

opposite sides a wing-shaped plate *e*. These wings *e*, with the prism *f*, form an arrangement for receiving in a suitable insertion the rotatory

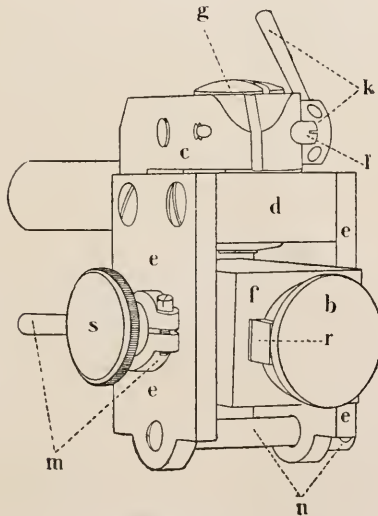

Fig. 100.

object-cylinder *b*. Fig. 101, which is a frontal section, through the vertical rotation-axis *xx*, gives further details, the section being so drawn as to show also the horizontal rotation-axis *yy*, which intersects the vertical axis *xx* in a point of the object cylinder axis. The author

gives full particulars of the details connected with rotation about the vertical axis, rotation about the horizontal axis, and rotation about the object-cylinder-axis.

4. The movement of the lever *F* is connected, by means of a strongly twisted cord of Chinese silk, with the rocking-lever *D*, but in a manner differing somewhat from the ordinary mode. One end of this cord is connected with a double eye (fig. 102), the larger eye engaging on one of the two screws v_1 or v_2 , of the lever. The cord then runs round the horizontal roller R_1 , then round the vertical roller R_2 , and finally over the roller R_3 inserted in the back part of the rocking-lever *D*. The cord, finally, is attached by its other end to the sliding-sleeve *E*, which is clamped on to *D* by the screw *w*. German-silver springs, only partly visible in the figure, prevent the cord from slipping out of place. The

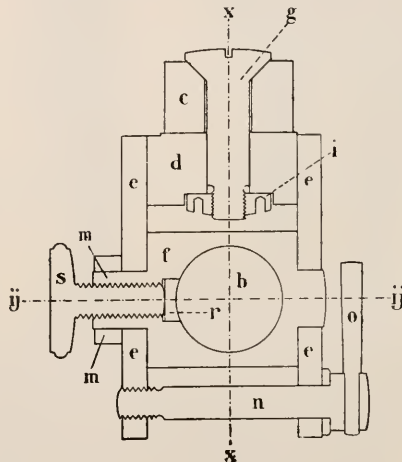

Fig. 101.

application and action of these three rollers distinguishes this microtome from the ordinary form, which introduces only two. The advantage is that the range-movement of the object can be varied by attaching the cord either to v_1 or to v_2 . In the last case the range is one-and-a-half times as great as in the first; this would be convenient in the case of cutting a very high object. Fig. 102 shows the working-lever in three positions: *F* is the rest position; F_2 the extreme position, and F_1 the position at which the forward removal of the object begins, the instrument being adjusted as *RM*_I (fig. 99) and arranged for sections $10\ \mu$ thick. It will be easily seen from fig. 102 that the cord at F_2 is longer than at F_1 . This means that the removal of the object is carried out only on the small final part of the object-track. With this same arrangement for section thickness, an object 23 mm. high can be dealt with if the cord is hooked on at v_1 , or 35 mm. high if the cord is attached to v_2 . With adjustment *RM*_{II} (fig. 99), these figures are respectively 20 and 31 mm.

The scale, with two graduations, is adapted to the operations for either RMI or RMII, or in the case of changing from the one to the other.

5. Each of the knife-rests (fig. 98) has a notch and three screws for receiving and fixing the knife; the small screws are for determining the most favourable obliquity for the knife, and the milled-head acts as a clamp. As efficiency is promoted and wear and tear diminished by choice of proper materials, the author introduces the best cast-steel for the ironwork; instead of soft brass, he uses a hard wear-resisting bronze-alloy.

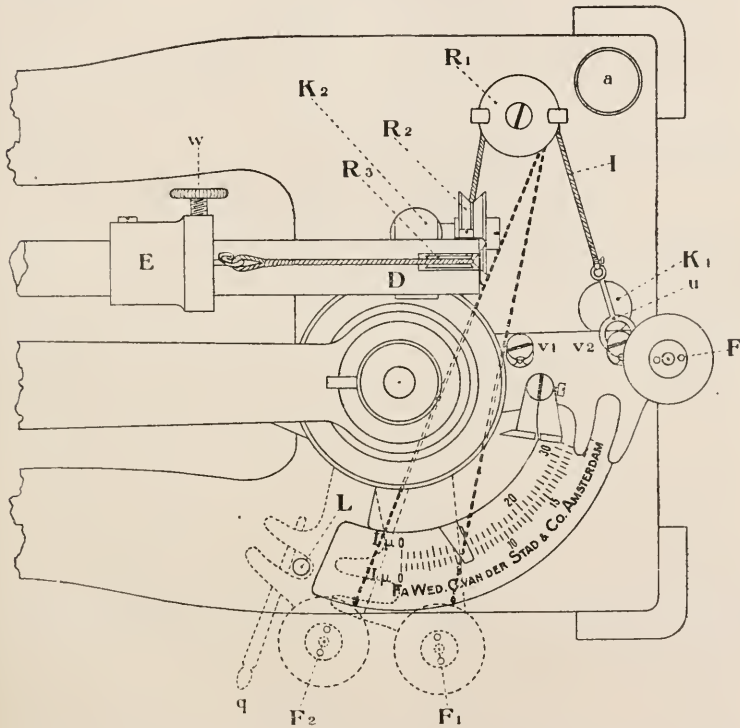

Fig. 102.

Fig. 103 shows an arrangement for ensuring thorough lubrication and for preventing shakiness of the working parts. The figure is a section through the region of the axial bolt T, about which the working-lever F turns. The sector G is not, as usual, directly rotatory about this bolt, but rotates with a long flange, G b, about a steel box, U. This box is thickened at its base, and rests on the base-plate. A flange on the bolt T fits on the thickening and keeps U firmly pressed down. The nut Tm below the base-plate tightens all up. The axis of the bolt T coincides with that of the box U. In this way the working-

lever F is flanged (F*b*) so as to fit into U. The between-space is filled with oil, which finds its way to the rotatory bolt T through perforations in the wall of the box F*b*. The connexion of the micrometer screw S with the rotatory bolt T is effected by means of the hardened steel conical wedge Z. This wedge has a hemispherical base which engages

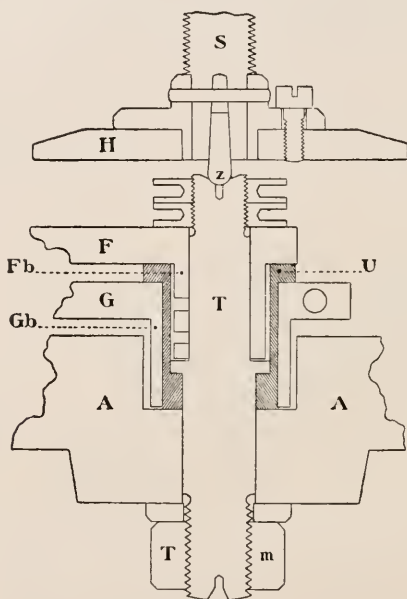

Fig. 103.

in a hemispherical socket in the top of the bolt T. The author considers that this device is superior to rounding off the base of the micrometer screw itself.

(4) Staining and Injecting.

Modification of Bielschowsky's Silver Method.*—P. Snessarew has devised the following modification of Bielschowsky's method for staining connective-tissue fibres. The chief alteration consists in immersing the sections in a solution of crystallized ammonium ferro-sulphuric crust. The procedure is as follows: The tissue is fixed in 10 to 15 p.c. formalin for a couple of hours; it is then washed in running water for 30 to 40 minutes, after which it is sectioned by the freezing method. The sections may be washed in a weak solution of formalin or be transferred straight away to 2½ to 10 p.c. solution of ammonium ferro-sulphuric crust. In this solution, which must be changed at least once a day, the sections remain at least four days. The solution must be kept in the

* Anat. Anzeig., xxxvi. (1910) pp. 401-11 (7 figs.).

dark, and 5 p.c. formalin may be added, but the addition does not appear to be indispensable. The rest of the technique follows the original lines.*

Diagnostic Value of the Staining Method of Gasis.†—This method depends upon the fact that certain organisms when stained with an acid stain are not decolorized by strong alkalis. Films stained with an eosin solution are treated with sodium hydrate, and counterstained with methylen-blue. It is thus the direct converse of the Ziehl-Neelsen process. It was claimed that, by this method, tubercle bacilli, which are alkali-fast, might be distinguished from other acid-fast organisms, more particularly smegma bacilli, which are decolorized. Levy has made trial of this process, and finds that it yields very satisfactory films, and thus renders easy the routine examinations for tubercle bacilli. On the other hand, the staining solutions are troublesome to prepare, and unstable. Further, he finds that smegma bacilli and other organisms of the acid-fast group are not always decolorized. He considers, therefore, that, as a means of diagnosis, the method is worthless.

Identity of Flemming's and Altmann's Granules.‡—N. Samssonow claims that the filaments found by Flemming in fresh cells are identical with the granules or threads found in fixed preparations made by the chondriosome method or by Altmann's procedure. He describes the methods used and the results of treating cartilage, connective-tissue and epithelial cells; fixation with modified Flemming's solution and staining with iron-hæmatoxylin, or with iron-alizarin and crystal-violet. The ripening of iron-hæmatoxylin (Meves) was accelerated by adding 2.5 c.cm. peroxide of hydrogen to 100 c.cm. of the solution.

Altmann's method consists in fixing very small pieces for 24 hours in a mixture of equal parts of 5 p.c. potassium bichromate and 2 p.c. osmic acid. Paraffin sections are stained in a solution consisting of 100 c.cm. anilin oil water plus 20 grm. acid-fuchsin. When on the slide the stain is heated till it vaporizes, and after cooling it is washed off with picric acid solution, made by mixing one volume of saturated alcoholic solution of picric acid with two volumes of water. The picric acid solution is renewed and the preparation placed in the incubator for 30-60 seconds to differentiate; then alcohol, xylol, balsam. The author prefers to differentiate in the cold.

F. Meves § pursues the same subject, but in connexion with leucocytes. He contends that his suspicion that the mitochondria and chondriokonts are identical with the granules and threads of Altmann is fully confirmed. In addition to the staining methods used by Samssonow he also adopted Schridde's modification of Altmann's method. This modification consists in placing the blood-films in Orth's mixture (Müller's fluid 9 parts, formalin 1 part) for 12 hours and afterwards for a similar time in Müller's fluid. The preparation is then washed in water, followed by 1 p.c. osmic acid for $\frac{1}{2}$ to 1 hour. The preparation

* See this Journal, 1906, p. 735; and 1908, p. 659.

† Centralbl. Bakt. 1te Abt. Orig., lv. (1910) pp. 253-5.

‡ Arch. f. Mikrosk., Anat. u. Entwickl., lxxv. (1910) pp. 635-41 (1 pl.).

§ Tom. cit., pp. 642-58 (1 pl.).

is again washed and then stained with acid fuchsin-picric acid according to Altmann's procedure. The illustrations seem to bear out the author's contention.

Detection of Tubercle bacilli in Fæces.*—R. W. Philip and Agnes E. Porter advocate the use of antiformin, a mixture of alkali hypochlorite and alkali hydrate for detecting tubercle bacilli in fæces. A piece, a cubic $\frac{1}{2}$ in. in size, is placed in a conical glass and to this about 20 c.cm. antiformin, which has been diluted with water to 15 p.c., is added. After well mixing up, a similar quantity of the dilute antiformin is added and the process repeated. After standing for about an hour a white layer appears. From this white curdy layer a drop is taken and placed on a slide along with a drop of albuminous water. A film made in the usual way is then stained with carbol-fuchsin and methylen-blue and afterwards decolorized with alcohol and acid.

Staining Trypanosoma dimorphon.†—E. Hindle smears a thin layer of albumen on a slide; on this a drop of blood or piece of an organ is smeared in the usual way, and the slide dropped face downwards into a jar of Flemming's strong solution. After 5 minutes or so it is removed and washed with water, and then passed through upgraded alcohols to absolute; after this it is removed to 80 p.c. alcohol containing iodine and potassium iodide; after an immersion of about 10 minutes it is passed into alcohols downgraded to 30 p.c.; it is then stained by either of the following methods:—

1. The film is stained in anilin-safranin for about an hour; after a wash in water it is treated with 1 p.c. aqueous solution of polychrome methylen-blue for one hour. The slide is again washed and then differentiated with Unna's orange-tannin; it is then passed through water, upgraded alcohols to anilin oil, cleared in xylol and mounted in balsam.

2. The film is mordanted for one hour in 3.5 p.c. aqueous solution of iron-alum and then stained for a similar time in 0.5 p.c. aqueous solution of hæmatoxylin, artificially ripened with a few drops of lithium carbonate solution. The preparation is then differentiated in iron-alum and mounted in the usual way.

Method of Staining Deep Colonies in Plate Cultures.‡—E. Dodson cuts out the colony from the agar-plate with a wet chisel and deposits it on a slide. The preparation is then dried at 37° C. and afterwards soaked in methylated spirit for 20 minutes. Surface crystals are now removed by immersion in 5 p.c. acetic acid for about 10 minutes. After this wash and dry in incubator for about 20 minutes. When dry pour on "Stephens' scarlet writing fluid" and allow to act until the colony is well stained, from 10 to 20 minutes. Mop up the superfluous fluid, and then pour on Loeffler's methylen-blue diluted with an equal volume of distilled water. Tilt the slide until the agar turns violet; to attain this end the preparation must be treated twice with blue. Next wash with water and then decolorize with alcohol until no more blue comes

* Brit. Med. Journ. (1910) ii. pp. 184-5.

† Univ. California Publications (Zool.) vi. (1909) pp. 127-42 (3 pls.).

‡ Lancet (1910) ii. pp. 310-11 (3 figs.).

off. Dehydrate with anilin oil, clear in xylol, and mount in balsam. The organisms are stained deep purple and the agar a pale green.

Demonstrating Tubercle Bacilli in the Blood.*—A. Lippmann obtains 10 c.cm. of blood from a vein by means of a syringe. The blood is placed in a flask along with 30 c.cm. of 3 p.c. acetic acid. The mixture is centrifuged for $\frac{1}{4}$ to $\frac{1}{2}$ hour, and then the supernatant fluid is poured off, while the deposit is treated with water. To the deposit are added 60 c.cm. of 15 p.c. antiformin, and the mixture incubated for $\frac{1}{2}$ to 1 hour. The fluid is again centrifuged, and, after washing the sediment twice with water, smears are made, fixed and stained in the usual way. Examination of the films is toilsome, as only a few bacilli are usually present. The author obtained positive results in 11 out of 25 cases.

(5) **Mounting, including Slides, Preservative Fluids, etc.**

Polyscopic Cell.†—C. S. Banks describes how to make a new microscopical accessory which will be useful to entomologists and also to general biologists. The polyscopic cell is merely a section of glass tubing of small calibre, made by grinding it to the form of a square prism by means of a rock-grinding apparatus. Lengths of glass tubing say 4–6 mm. in diameter, are cut into pieces from say 15–20 mm. long. Nine to a dozen of these are fastened to a small plate of glass by means of a mixture of 20 parts white shellac and 7 parts Canada balsam. This, in the form of a pencil, is applied to the glass plate held over the gas flame, until a sufficient quantity has melted upon the plate. The short tubes are then placed close together and pressed down upon the plate so that they will all be parallel. The cement having become hard, the tubes are ground down upon the steel wheel of a rock-grinding machine, the operator employing first coarse emery and then finer until their surfaces have become worn to the desired degree and have the velvety appearance of ground glass. A still finer polish may be obtained by next grinding for a short time on a plate glass with pumice and water. The next step is to dry the plate and gently heat it until the tubes become loose enough for removal. The entire mass of adherent tubes may be slipped off, turned completely over, pressed firmly to the glass plate to remove air bubbles and, after cooling, the operation of grinding the faces on the opposite side begun. This being completed, the tubes are now removed as before, set up on edge so that their plane faces are contiguous, re-cemented to the plate and the third face ground. For the fourth face, the mass may be slipped off entire and turned over, the same precautions being taken to press the mass flat to the plate. The cells may now be removed from the plate and, after cleaning off the cement, they are ready for use. They may, however, be polished even more finely if it is so desired, to remove the ground surface and render them perfectly transparent like ordinary glass slides; but this is not absolutely necessary, for the following reasons: After mounting the specimen, the only thing necessary when it is desired to study it under the Microscope is to place a drop of immersion oil on the top of the cell

* Muenchen. Med. Wochenschr., lvi. (1909) pp. 2214.

† Philippine Journ. Sci., v. (1910) pp. 78–83 (2 pls.).

and press over it a tiny piece of cover-glass. This causes a perfect transparence on the top of the cell and makes the enclosed specimen visible. The only special advantage of having the cell polished is to enable one to determine quickly the position of the specimen within. An advantage of leaving the cell with ground sides is that the number and name of the specimen may be written easily upon the surface with India ink.

This slide-cell, though chiefly intended for minute insects and parts of insects, may also be used for Crustacea, Arachnida, Rhizopoda, Vermes, etc.

The method of use is very simple: it is only necessary to select a slide-cell of suitable calibre, fill it with xylol-balsam, and then push it in the preparation. The ends of the tube are then cemented up.

(6) Miscellaneous.

Removing Over-hardening in Anatomical and Histological Preparations, and New Method of Silver Impregnation.*—It is well known, says F. W. Schmidt, that formalin over-hardens, and that consequently preparations become unsuitable for further examination. Noticing that formalin did not harden silver-gelatin emulsions though gelatin alone was rendered very hard, the author ascribed this effect to the action of the silver salts; and working on the basis that animal tissues might behave as gelatin does, he set about experimenting. He immersed *Alburnus bipunctatus* in formalin until it was as hard as a board, and afterwards in 1 p.c. silver nitrate solution. In about 14 days the brittleness was removed. Larger objects, such as *Gadus aeglefinus* L., required a little longer. Of course the objects were stained by the silver, and especially in certain parts. The author then turned his attention to the preventing of this staining, and also to ascertain if any substance would also remove the brittleness. He found that a 1:10 solution of citric acid would render the formalin-fixed specimens pliable, but as this was expensive he used $\frac{1}{2}$ p.c. nitric acid. Reverting to his observation that the silver nitrate stained the objects, he goes on to show that formalin-silver nitrate preparations are available not only for macro-, but for microscopical examination, and gives the following procedure:—(1) hardening in 10 p.c. formalin; (2) immersion in 10 p.c. citric acid for 14 days; (3) immersion in 1 p.c. silver nitrate solution for 8 to 14 days. The method is stated to be specially useful for the nervous system.

* Anat. Anzeig., xxxvi. (1910) pp. 652-4.

Metallography, etc.

Aluminium-zinc Alloys.*—W. D. Bancroft has determined the tensile strength of alloys prepared from aluminium and zinc, both of high purity. The alloys were melted in artificial graphite crucibles, and were cast at temperatures 50° C. above their melting points, in graphite moulds. From 0 to 4 p.c. aluminium the tensile strength increases from about 4 to 11 tons per square inch, from 4 to 60 p.c. it increases more gradually to 16 tons, and then decreases to about 6 tons for pure aluminium.

Aluminium-copper-tin Alloys.†—C. A. Edwards and J. H. Andrew have amplified their work on this ternary system,‡ investigating the constitution and determining the properties of numerous alloys. In accordance with the method recommended by Shepherd and Upton, metallographic examinations were relied upon for the location of the boundary lines of the different phases. The original paper, with diagrams and photomicrographs, should be consulted for the details of the constitution of the alloys. No ternary compound is deposited from the liquid alloys, and no ternary eutectic is formed. An alloy containing 10 p.c. tin and 9 p.c. aluminium is a homogeneous solid solution at 900° and at 500° C., but at interjacent temperatures reactions occur in it producing quite different structures showing two phases. The authors suggest that at 900° C. the γ' copper-tin phase is in solution with the β phase, while at 500° C. it is the δ' in solution with β . This implies that the identity of a phase or constituent is not destroyed when in solution.

Copper-zinc Alloys.§—T. Turner and T. M. Murray have determined the changes of length of cast bars of numerous copper-zinc alloys and of some pure metals when cooling from the solidifying temperature. The extensometer used was an improved form of the instrument previously employed for similar work.|| The temperature of the bar was taken during cooling by a thermojunction; cooling curves were obtained in this way in addition to the volume-change curves. The cold alloys were examined microscopically, and their hardness determined by the Shore scleroscope and the Brinell method. The pure metals, after solidification, contracted in the mould at a uniformly decreasing rate. Most of the brasses expand on solidification, the maximum and minimum expansion corresponding respectively to the greatest and least distances of the "solidus" from the "liquidus" curve in the equilibrium diagram. There is a remarkably large expansion with the alloy containing 14.76 p.c. copper. A maximum total shrinkage, and a maximum hardness at 40 p.c. copper point to the existence of Cu_2Zn_3 , supported by microscopical and other evidence.

* Trans. Amer. Brass Founders' Assoc., 1909, pp. 47-54, through Journ. Soc. Chem. Ind., xxix. (1910) p. 159.

† Journ. Inst. Metals, ii. (1909) pp. 29-57 (32 figs.).

‡ See this Journal, 1910, p. 119.

§ Journ. Inst. Metals, ii. (1909) pp. 98-150 (31 figs.).

|| See this Journal, 1905, p. 743.

Corrosion of Bronzes.*—F. Giolitti and O. Ceccarelli have shown that the rate of corrosion of bronzes bears a relation to their microstructure. Bronzes containing less than 10 p.c. tin were annealed at different temperatures, or cooled rapidly or slowly after casting. After microscopical examination, weighed cylinders were immersed in a dilute solution of hydrochloric acid and ferric chloride for a given time, and the loss of weight determined. The conclusions reached may be briefly expressed as follows. 1. Two bronzes of the same composition, but differing in microstructure, as a result of different thermal treatment, may differ widely in their resistance to corrosion. 2. Corrosion is accelerated by the simultaneous presence of the two solid solutions α and β . 3. The velocity of corrosion increases as the difference of concentration between nucleus and edge of individual crystals is greater. Thus microscopical examination of a bronze may afford data on which to base a conclusion as to its capacity for resisting corrosion.

Zinc Amalgams.†—E. Cohen and K. Inouye have worked out a method of determining the solubility of zinc in mercury, which avoids the considerable errors resulting from previous methods. The solubility curve from 0 to 100° C. has been determined, and shows a regularly increasing solubility with rising temperature.

Copper-arsenic Alloys.‡—G. D. Bengough and B. P. Hill have studied the mechanical properties of five bars of copper containing 0.04 to 1.94 p.c. arsenic, in three states: (1) as rolled; (2) annealed in an oxidizing atmosphere; (3) annealed in a reducing atmosphere. Bars with less than 1 p.c. arsenic were injured by reducing gases at temperatures above 650° C.; the authors suggest, as a cause, the reduction of arsenious oxide with the sudden formation of gases within the metal and insoluble in it. The constitution of the copper-arsenic alloys was investigated by means of thermal and microscopical examination of thirty-six alloys containing 0.9 to 44.4 p.c. arsenic. The existence of Cu_3As and Cu_5As_2 has been confirmed; no evidence of the existence of Cu_2As was found. The authors consider that a true equilibrium diagram of the system cannot be constructed by ordinary methods, for the rates of cooling used appeared to be too rapid to allow the change in the solid to complete itself at the critical temperatures, and too slow to allow of constancy of composition. An alkaline solution of copper-ammonium chloride was used for etching some of the alloys.

Phosphor-bronze.§—O. F. Hudson and E. F. Law state the conclusions they have reached as to the constitution of the copper-tin-phosphorus alloys, illustrating them by a series of remarkably good photomicrographs. The two compounds Cu_4Sn and Cu_3P form a binary eutectic, and together with the tin-copper solid solution α give rise to a ternary eutectic containing 81 p.c. copper, 14.2 p.c. tin, 4.8 p.c. phosphorus. The experimental data on which the authors' conclusions are

* Gazz. Chim. Ital., xxxix. (1909) pp. 557-75, through Journ. Soc. Chem. Ind., xxix. (1910) p. 281.

† Zeitschr. Phys. Chem., lxxi. (1910) pp. 625-35 (2 figs.).

‡ Journ. Inst. Metals, iii. (1910) pp. 34-97 (26 figs.).

§ Tom. cit., pp. 161-86 (27 figs.).

founded are not stated. The sections for microscopical examination were finally polished with Globe polish, by hand. The best etching reagent for these, as for the majority of copper alloys, is a 10 p.c. aqueous solution of ammonium persulphate. This reagent dissolves copper and certain other metals without the evolution of gas, or the formation of a surface film. The surface, previous to etching, should be perfectly freed from grease. The most satisfactory photomicrographs are secured by using colour plates.

Zinc Bronzes.*—L. Guillet and L. Révillon give the first results of an investigation of the effect of other metals on the copper-tin alloys. In cases in which zinc was the third metal, it was observed that the δ -phase existed when the tin content was below the percentage expressing the solubility of tin in copper. The microscopical appearance resembled that of an alloy containing somewhat more tin than the amount present. The effect of the zinc may be expressed by a "coefficient of equivalence," in the same way as the effect of a third metal on the copper-zinc alloys has been expressed. The examination of six alloys containing 13.7 to 4.6 p.c. tin, 1.7 to 10.2 p.c. zinc, and about 85 p.c. copper, has shown that the "coefficient of equivalence" of zinc in bronzes is very nearly 0, the zinc going into solution in the α -phase without seriously altering the limit of solubility of tin. Results of mechanical tests of twenty-one copper-tin-zinc alloys are given.

Ternary System Iron-copper-nickel.†—R. Vogel has employed principally microscopical methods for the determination of the limits of saturation of the ternary mixed crystals occurring in this system. Specimens were submitted to long annealing to obtain equilibrium. Cooling curves of some twenty-five alloys were taken. In the triangular diagram, alloys of compositions lying outside a continuous curve passing through the limits of saturation are, if sufficiently annealed, homogeneous solid solutions.

Light Alloys.‡—W. Rosenhain reviews the progress made in the production of alloys combining great strength with a low specific gravity. Aluminium, which in the pure state is weak, may be strengthened by the addition of copper, alone or with manganese, or of zinc, or of other metals. The effect of such additions upon corrosion is discussed. Alloys of magnesium are beginning to find practical application.

Thermo-electricity of Alloys.§—E. Rudolphi has investigated the relation between constitution and thermo-electric properties of alloys. Ten representative binary systems were examined, the E.M.F. developed by each alloy against copper and against nickel being measured. One junction was kept in molten ice, the other was heated in a paraffin bath. Binary systems are classified in four groups: (1) neither compounds nor solid solutions are formed, the concentration-E.M.F. curve is a straight line; (2) the components form a continuous series of solid

* Rev. Métallurgie, vii. (1910) pp. 429-32 (2 figs.).

† Zeitschr. Anorg. Chem., lxxvii. (1910) pp. 1-16 (14 figs.).

‡ Nature, lxxxiii. (1910) pp. 461-2.

§ Zeitschr. Anorg. Chem., lxxvii. (1910) pp. 65-96 (12 figs.).

solutions, the curve is U-shaped; (3) solid solutions of limited concentration are formed, the curve is modified accordingly, showing an inflection at the limit of saturation of the mixed crystals; (4) a compound is formed, the curve having a maximum at the concentration corresponding to the compound. These rules are compared with those expressing the relation of hardness and electrical conductivity to concentration.

Nitrogen and Metals at High Temperatures.*—I. Shukow has made determinations of the dissociation pressures of metal-nitrogen alloys. The continuous increase of the dissociation pressure with nitrogen content in the case of chromium and manganese proves the alloys to be solid solutions, not compounds. With aluminium the dissociation pressure is constant for a given temperature, and independent of nitrogen content, indicating the presence of an aluminium-nitrogen compound. From these results, and from those obtained in determinations of electrical resistance of metal-nitrogen alloys, the author concludes that nitrogen forms solid solutions but no compounds with manganese, chromium, and titanium.

Effect of Silicon and Sulphur on Cast-iron.†—It is well known that sulphur tends to make cast-iron white by retaining the carbon in the combined state, and that silicon tends in the opposite direction. J. E. Stead reviews the work of previous investigators, and gives the results of a micro-chemical study of the causes of these phenomena. The three pig-irons examined, which illustrate well the effects considered, contained:—

—	White	Grey glazed iron	
		No. 1.	No. 2
Combined carbon	2.98 p.c.	nil	trace
Graphite	traces	2.65 p.c.	3.30 p.c.
Manganese	0.29 p.c.	0.72 „	0.68 „
Silicon	1.89 „	5.21 „	4.32 „
Sulphur	0.27 „	0.03 „	0.025 „
Phosphorus	1.62 „	1.56 „	1.66 „

The white iron contained no iron-iron-carbide eutectic, its place being taken by the ternary eutectic of the iron-phosphorus-carbon system. These and other alloys were submitted to various chemical treatments, to separate the carbides, and metallurgical treatments, such as re-melting with additions of sulphur or of manganese, and were microscopically examined in their different states. The author concludes that carbide of iron in presence of iron-sulphide crystallizes with an amount of sulphur not exceeding about 0.1 p.c. of the weight of the

* Journ. Russ. Phys. Chem. Ges., xlii. (1910) pp. 40-55, through Journ. Soc. Chem. Ind., xxix. (1910) p. 572.

† British Assoc., 80th Rep., Sheffield, 1910. Chemical Section, President's Address, 13 pp. (9 figs.).

carbide, and that the presence of the sulphur renders the carbide stable. The effect of increasing sufficiently the percentage either of silicon or of carbon in an iron-silicon-carbon alloy containing only moderate amounts of these two elements, is to cause the formation of a carbo-silicide of iron. This carbo-silicide appears to be unstable, readily decomposes into graphite and silico-austenite, and is the cause of the greyness of high-silicon cast-iron.

Ferro-silicon.*—S. R. Bennett reports on the composition and structure of these alloys. Published work is first summarized. Determinations of the specific gravity of numerous alloys indicate the probable existence of Fe_2Si and FeSi , but do not support the existence of FeSi_2 or Fe_3Si_2 . Several alloys were microscopically examined Up to 20 p.c. Si the alloys consist of solid solutions of Fe and Fe_2Si which are hard, firm masses giving off little or no gas. Alloys from 20 to 21.6 p.c. Si consist of primary crystals of Fe_2Si in a ground of eutectic composed of Fe_2Si and Fe Si; these alloys begin to get more brittle than the lower grades. From 21.6 to 33.3 p.c. Si the structure shows FeSi surrounded by eutectic Fe_2Si and FeSi; from 33.3 to 60 p.c. Si there are crystals of FeSi in eutectic FeSi + Si; and above 60 p.c. Si crystals of Si in a field of eutectic FeSi and Si.

Influence of Antimony and Tin on the Iron-Carbon System.† P. Goerens and K. Ellingen have examined two series of ternary alloys, prepared by the addition at 1350° C. of antimony or tin to molten Swedish pig-iron containing 3.66 p.c. carbon. One series (11 alloys) contained 5.8 to 59.3 p.c. antimony; the other (12 alloys), 0 to 11.1 p.c. tin. The carbon content in the antimony series was steadily lowered by the antimony additions, falling to 0.3 p.c. in the 59.3 p.c. alloy. The effect of tin on carbon content was in the same direction, but was comparatively slight. Cooling curves, chemical analyses, and microscopical examination were made. The two ternary systems resemble the iron-carbon-phosphorus system in that a ternary eutectic is formed on solidification. In the antimony series this eutectic solidifies at about 950° C. Neither antimony nor tin changes the pearlite-formation temperature. Three constituents were observed in each alloy—pearlite, cementite, and antimonide or stannide of iron. The pearlite is rapidly etched by picric acid and appears dark; cementite remains white; antimonide or stannide become light grey after long etching. Cementite may be distinguished from antimonide or stannide by heat-tinting, the cementite colouring more rapidly in each case.

Specific and Latent Heats of Molten Cast-iron.‡—W. Schmidt has determined the total heat evolved when 500 grams of pure cast-iron, containing 4.3 p.c. carbon (about the eutectic composition) cooled to 0° C. from 1375°, 1275°, 1175° and 1130° C., the last temperature being just below the solidification point. The cooling took place in a crucible within an ice calorimeter, the temperature being measured by

* Local Govt. Board Rep., 1908-9. Supplement on nature, uses, and manufacture of ferrosilicon, 1909, pp. 90-96.

† Metallurgie, vii. (1910) pp. 72-9 (10 figs.).

‡ Tom. cit., pp. 164-8 (1 fig.).

means of a thermocouple, and required 16 to 20 hours. The volume of water melted was measured and corrected. The following values were obtained:—Specific heat of molten cast-iron of eutectic composition in the ranges 1175° to 1275° C. = 0.3136 ; 1275° to 1375° C. = 0.3216 ; latent heat of solidification of 1 gram = 59 calories.

Effect of Temperature upon the Magnetic Properties of Electrolytic Iron.*—E. M. Terry has determined the magnetic properties of iron at temperatures between -190° and 785° C. Burgess electrolytic iron of remarkable purity was used, 0.07 p.c. of hydrogen and 0.012 p.c. carbon being the principal impurities present. The specimens were examined microscopically after different treatments. The author finds that ferromagnetism reappears on cooling at the same temperature (785° C.) at which it disappears on heating.

ARRIVAUT, G.—**Melting-point Diagram of the Silicon-silver Alloys.**

Procès-verbaux des séances de la Société des Sciences physiques et naturelles de Bordeaux, 1908-9, pp. 9-14 and 20 (1 fig.)
See also this Journal, 1909, p. 264.

BORNEMANN, K.—**Binary Metallic Alloys.**

[A continuation of the summary of published work. (See this Journal, 1909, p. 787.)]
Metallurgie, vii. (1910) pp. 103-10 (25 figs.).

DUCELLIEZ, F.—**Chemical Study of the Cobalt-bismuth Alloys.**

[No compound is formed, and cobalt and bismuth are only miscible to a small extent in the molten state.]

Procès-verbaux des séances de la Société des Sciences physiques et naturelles de Bordeaux, 1908-9, pp. 21-4.

” ” **Cobalt-copper Alloys.**

[No compounds were found.]

Tom. cit., pp. 120-6 (1 fig.).

” ” **Electromotive Forces of Cobalt-bismuth Alloys.**

Tom. cit., pp. 126-9 (1 fig.).

” ” **Cobalt-lead Alloys.**

Tom. cit., pp. 129-31 (1 fig.).

” ” **Cobalt-antimony Alloys.**

Tom. cit., pp. 131-4 (1 fig.).

” ” **Cobalt-tin Compounds.**

Tom. cit., pp. 134-6 (1 fig.).

FRIEDRICH, K.—**Technical Thermal Analysis of Metallurgical Processes.**

Metallurgie, vii. (1910) pp. 33-9.

GUILLET, L.—**Cementation.**

[The author makes some theoretical and practical observations. A mixture of wood-charcoal (60 p.c.) and barium carbonate is recommended as a cementation agent. For practical purposes a temperature of at least 850° C. is necessary.]
Rev. Metallurgie, vii. (1910) pp. 496-500.

RENGADE, E.—**Theoretical Form of Cooling Curves of Binary Mixtures.**

[The subject is treated mathematically.] *Tom. cit.*, pp. 89-97 (5 figs.).

VIGOUROUX, E.—**Electromotive Forces of Nickel-copper Alloys.**

[No evidence of the existence of a compound was obtained.]

Procès-verbaux des séances de la Société des Sciences physiques et naturelles de Bordeaux, 1908-9, pp. 114-19 (1 fig.).

* Physical Review, xxx. (1910) pp. 133-60 (18 figs.).

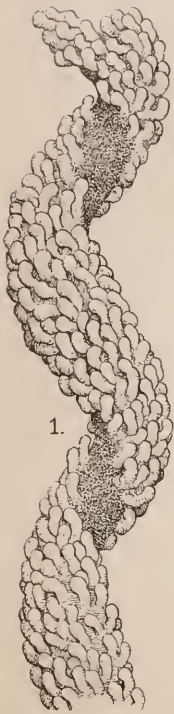

1.



4a.



4b.



2a.



6a.



6b.

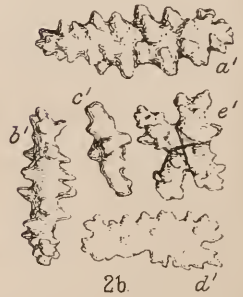

2b



3a

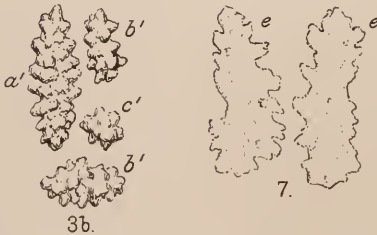

3b.



7.

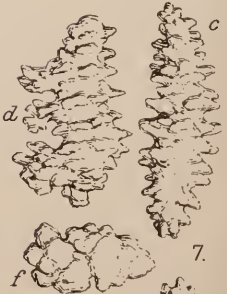

7.

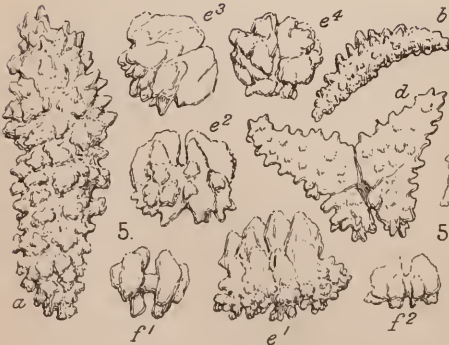

5.

5.

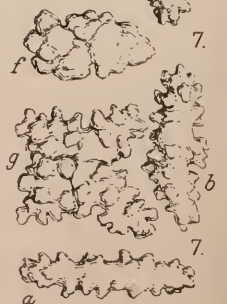

7.

JOURNAL
OF THE
ROYAL MICROSCOPICAL SOCIETY.

DECEMBER, 1910.

TRANSACTIONS OF THE SOCIETY.

XIV.—*Hicksonella*, a New Gorgonellid Genus.

By JAMES J. SIMPSON, M.A., B.Sc.
(Carnegie Fellow, University of Aberdeen.)

(Read October 19, 1910.)

PLATE XIII.

IN my recently published "Revision of the Juncellid-group of the Gorgonellidæ,"* I did not include any notice of the unique form described by Professor S. J. Hickson under the name of *Juncella spiralis*. Its puzzling and divergent character made a separate discussion advisable.†

In the Revision the Juncellids were divided into three genera, namely, *Juncella*, *Scirpearia*, and *Nicella*, and an examination of the diagnoses given there, along with the following descriptions,

* Proc. Roy. Irish Acad., No. 7 (1910) pp. 247-386 (19 pls.).

† I wish to take this opportunity of thanking Professor J. Arthur Thomson for entrusting these forms to me for identification and description, and also the Carnegie Trust for a grant to cover the cost of the illustrations.

EXPLANATION OF PLATE XIII.

- Fig. 1.—Portion of *Hicksonella spiralis*, enlarged to show the spiral form and also the distribution and nature of the verrucæ. $\times 3$.
,, 2.—Spicules from the verrucæ of ditto: (a) near base, (b) near tip.
,, 3.—Spicules from the cœnenchyma of ditto: (a) near base, (b) near tip.
,, 4.—Two views of the same portion of *H. flagellata* sp. n.: (a) polyp-bearing, (b) non-polyp-bearing aspect. $\times 4$.
,, 5.—Spicules of ditto.
,, 6.—Two views of the same portion enlarged of *H. capensis* sp. n.: (a) polyp-bearing, (b) non-polyp-bearing aspect. 1×4 .
,, 7.—Spicules of *H. capensis* sp. n.

Dec. 21st, 1910

2 Z

will show the impossibility of linking the specimens now under consideration to any of these genera. It will be shown that it is necessary to establish a new genus.

As a full description of the *Juncella spiralis* type has been given by Hickson,* we may briefly consider some of the most characteristic features before proceeding to any taxonomic consideration. The colonies were all unbranched; one of them was 220 mm. in length without the base, which had been broken off. The axis was pale brown in colour, and had rings of lime embedded in the horny matrix. The verrucæ were all prominent and arranged irregularly on two-thirds of the circumference of the stem, leaving a bare track on one side free from verrucæ from end to end of the colony. The bare track and verrucæ were covered with a dense armature of spicules, and "it is difficult to believe that the verrucæ can ever be retracted." The spicules consisted chiefly of irregularly tuberculated plates and spindles. "The spicules are tightly jammed together to form an impenetrable armour. The surface of the verrucæ has a distinctly squamate appearance, the plate-like spicules slightly over-lapping."

Hicksonella † *spiralis* g.n. (= *Juncella spiralis* Hickson).

Plate XIII. figs. 1-3.

Two specimens referable to this species occur in a collection from Cape Colony. Professor Hickson very kindly sent me a small portion of his type specimen for examination, and one of the present colonies agrees with it in almost every feature. It is 40 cm. in length, the diameter is 3.5 mm. near the base, and about 2 mm. at the tip. The tapering is thus very gradual, in fact at a distance of 7 cm. from the tip there is very little difference in the diameter from that at the base.

Another specimen is 20 cm. in length, and has a maximum diameter of 2.5 mm. at the base. In both specimens the basal part is wanting.

The axis is densely calcareous, and very hard in the lower portion, so that, except near the apex, the colony is very rigid. It is composed of concentric laminæ of the typical Gorgonellid type. There is a distinct, central, more densely calcareous portion, and the surface is marked by a series of minute longitudinal furrows. The diameter near the present base is 1.5 mm., but this diminishes gradually to a hair-like fineness at the tip.

* The Alcyonaria of the Cape of Good Hope. Part II., Marine Investigations in South Africa, iii. (1904) pp. 231-33 (4 figs.).

† I wish to associate with this new and remarkable genus the name of Professor Sydney J. Hickson, D.Sc. F.R.S., who has done so much to elucidate the structure and relationship of Alcyonarians, and to whom we are indebted for the original observations on *Hicksonella*.

The cœnenchyma is very thin and densely spiculose; when dry it is extremely brittle.

The canal system is difficult to determine owing to the thinness of the cœnenchyma. It was found impossible to detach a portion of the cœnenchyma from the axis without damaging the canals. Serial sections were made from a decalcified portion of the cœnenchyma, but the results were not very satisfactory. The furrows on the axis suggest a concentric series of canals separating the cœnenchyma from the axis, but it is very doubtful whether one or more of these is larger than the others, and the possession of an outer series of canals is quite uncertain.

From end to end of the colony there is a narrow streak devoid of polyps, which participates in the spiral arrangement of the colony (pl. XIII. fig. 1). It occupies between one-fourth and one-third of the circumference of the cœnenchyma. The remaining three-fourths to two-thirds is densely covered with small elongated verrucæ. In the smaller specimen the basal portion, for a distance of 8 cm., is devoid of polyps.

The verrucæ are long and club-shaped, and somewhat resemble those of *Scirpearia flagellum*; the terminal part is considerably enlarged. They are about 1.5 mm. in length, and about 0.5 mm. in diameter at the widest part. They are very spiculose, and the surface, when viewed with a lens, reveals a series of minute horizontal, overlapping scales, which recalls the armature of a Caligorgid.

At the utmost they are only feebly retractile into the cœnenchyma, but their enormous size, the thinness of the cœnenchyma and their dense armature, would seem to preclude the possibility of any great degree of retraction.

When the tentacles are inturned there is a distinct eight-rayed figure at the summit of the verrucæ, and the scales on the aboral surface of the tentacles form a sort of pseudo-operculum. Further retraction of the tentacles results in a very definite horizontal wrinkling of the verrucæ.

The verrucæ are very densely packed on the polyp-bearing region, and about a dozen occur on one transverse line.

Young polyps occur scattered among the older ones, and so render any definite arrangement impossible.

In the larger specimen the colour of the cœnenchyma in the bare tract is a dark brick-red, but the verrucæ are creamy white with an occasional trace of an orange tint. In the smaller specimen the bare tract is also reddish-orange, but the polyps are pinkish-purple.

The spicules of this species are extremely characteristic, but very diverse in form and irregular in outline.

The figs. 2 *a*, *b* and 3 *a*, *b*, show some of the more definite types.

Fig. 2 shows those of (*a*) the verrucæ near the base, (*b*) the verrucæ near the tip.

Fig. 3 shows those of (*a*) the cœnenchyma near the base, (*b*) the cœnenchyma near the tip.

The following is a list of the chief types with their measurements (length by breadth in millimetres):

I. Cœnenchyma:

1. Spindles, very thick with close-set warts. (0.046×0.019 ; 0.046×0.015 ; 0.042×0.019 .)
2. Short, stumpy spindles, densely warted. (0.027×0.019 ; 0.027×0.015 ; 0.023×0.015 .)
3. Almost spherical warty forms. (0.019×0.019 ; 0.015×0.015 ; 0.012×0.012 .)

II. Polyyps:

1. Long thick spindles, with fewer and longer warts than in (*a*) of the cœnenchyma. (0.053×0.012 ; 0.046×0.015 .)
2. Spindles with very few long warts. (0.042×0.011 ; 0.038×0.015 .)
3. Spindles, still shorter, and with fewer warts. (0.031×0.015 ; 0.027×0.012 .)
4. Flat, irregular scales from the verrucæ. (0.034×0.015 ; 0.031×0.011 .)
5. Crosses. (0.038×0.019 ; 0.031×0.031 .)

Locality:—Cape Morgan, N.N.E. $9\frac{3}{4}$ miles; depth, 47 fathoms; bottom, broken shells (25. vii. 01). Previously recorded from Cape Morgan, $32^{\circ} 45' 45''$ S., $28^{\circ} 26' 15''$ E.; 36 fathoms; stones (12. i. 01).

Hicksonella flagellata sp. n. Plate XIII. figs. 4, 5.

To this new species we refer two small complete specimens and a portion of a much larger specimen from the Cape. The longer complete colony is 20 cm. in length and the shorter is 12 cm., while the length of the broken portion is also 20 cm. The first specimen has a maximum breadth of 2 mm.; the second is about the same size; the fragment is 3 mm. in breadth.

The cœnenchyma is extremely thin in all the specimens, and in the non-polyp-bearing part the dark axis is easily seen through it. It is densely spiculose and extremely brittle, especially when dry. The surface is very arenaceous in appearance.

The axis is comparatively soft; it is composed of concentric laminae, which consist of a horny substance in which calcareous matter is deposited.

From end to end of the colony there runs a streak devoid of polyyps and occupying about one-third of the circumference of the stem. The polyyps occur densely packed on the remainder of the circumference; these project laterally and so add to the breadth of

the colony. Towards the base the polyps diminish in number while on the basal 4 or 5 cm. they are altogether absent. No definite arrangement is discernible, and young polyps occur scattered amongst the older forms.

The verrucæ are elongated and club-shaped (pl. XIII. fig. 4a); they are about 1.5 mm. in length and about 0.5 mm. in diameter near the apex. They are not retractile into the cœnenchyma, and the swollen terminal part is due to the withdrawal of the anthocodia within the verruca. They are densely spiculose, and the scales on the aboral surface of the tentacles form a pseudo-operculum to the partially retracted anthocodia. Fig. 4b shows the characteristic appearance of the portion figured in 4a from the non-polyp-bearing aspect.

The spicules (pl. XIII. fig. 5) of this species are very characteristic. The following are some of the chief types, with measurements, length by breadth, in millimetres:—

1. Thick, massive, warty spindles. (0.053×0.015 ; 0.049×0.011 ; 0.038×0.015 ; 0.038×0.011 .)
2. Smaller; usually curved spindles with the warts more developed on the convex side. (0.046×0.008 ; 0.031×0.008 .)
3. Irregular scales (from the verrucæ). (0.031×0.011 ; 0.027×0.015 .)
4. Aberrant type, resembling crosses. (0.034×0.023 .)
5. Peculiar, bilaterally symmetrical type with a sort of thick foliaceous expansion. (0.015×0.015 ; 0.015×0.011 ; 0.011×0.011 .)
6. Birotate forms (like those in *Subergorgia verriculata*). (0.011×0.008 ; 0.008×0.008 .)

Locality:—Cape Morgan, N. $\frac{1}{2}$ W., $10\frac{1}{2}$ miles; depth, 77 fathoms. By dredge. Rocks and broken shells (26. vii. 1901).

Hicksonella capensis sp.n. Plate XIII. figs. 6, 7.

This species has been established to include a very characteristic colony 75 cm. in length without the basal portion. The diameter at the present base is 3.5 mm.; midway it is 3.25 mm., while near the tip it is 3 mm., so that the tapering is very slight. The actual tip is conical.

The colony is twisted in an irregular open spiral throughout its entire length, but in such a way that the bare tract is always to the inside.

The cœnenchyma is extremely thin and is densely spiculose. The axis is composed of concentric laminae, which consist of a horny substance impregnated with some form of calcareous matter. It is very hard, white in colour, and the surface is marked by deep longitudinal furrows. It tapers to a hair-like fineness at the tip.

The polyps are disposed over about three-fourths of the surface of the colony, leaving a bare longitudinal track which is very marked in the lower part, but almost disappears in the upper portion. The verrucæ are small, elongated and slightly club-shaped; they are about 2.5 mm. long and 0.25 mm. in diameter, and are much more openly disposed than in the other species (pl. XIII. fig. 6a). Fig. 6b shows the appearance from the non-polyp-bearing aspect. The tentacles are first infolded and then withdrawn into the upper part of the verrucæ, but the verrucæ themselves are not retractile into the cœnenchyma. The colour of the cœnenchyma is orange-red, but the verrucæ are almost white.

The spicules of this species are extremely irregular in form, but the following types may be distinguished (pl. XIII. fig. 7):—

1. Short slightly warty spindles. (0.07×0.015 .)
2. Spindles longer and more warty. (0.09×0.038 ; 0.08×0.038 .)
3. Spindles still longer and more warty. (0.13×0.05 ; 0.14×0.046 ; 0.16×0.065 ; 0.2×0.06 .)
4. Very irregular forms (probably developed from [3]). (0.17×0.11 ; 0.16×0.13 .)
5. Flat, irregular scales. (0.14×0.09 .)
6. Thick, warty, almost spherical forms. (0.06×0.045 ; 0.053×0.034 .)
7. Crosses (aberrant). (0.12×0.11 .)

Locality:—Red Cliff, S. of Morewood Cave, N.W. $\frac{3}{4}$ N. $6\frac{1}{2}$ miles. Natal. Depth, 37 fathoms; bottom, sand and shells.

Position of Hicksonella.

In this connexion the axis stands first to be considered. As will be seen from the descriptions of the various species, it is composed of concentric laminae; these laminae consist of a horny substance containing some form of calcareous deposit. It has been impossible so far to determine the nature of this limy deposit, but it is hoped that some solvent may be found to decompose the organic matter, and so enable a microscopic examination of the inorganic residue to be made. Until this is done, however, determination based on axial structure is impossible. We have, however, in our Revision of the Juncellids, discussed the possible affinities of several other specimens whose axis is similar to the one under consideration, and the resemblance strongly suggests that the present specimens approach closely to the Gorgonellidæ, to which family we would therefore temporarily assign them.

In the work cited above, after an exhaustive examination of a very large number of Juncellids, we suggested an emended classification, and included in the genus *Juncella* only those species whose spicules contained the type known as "clubs." This type of spicule

was first described and figured by Kölliker in his *Icones Histologicae*, p. 140, taf. xviii. fig. 46. In the Revision of the Juncellid-group of the Gorgonellidæ several figures of this type of spicules are given (fig. 4, a-g).

The general form approaches that of the well-known "Indian club;" there is a distinct smooth median part or handle, which is surmounted by a few spines. The club-part also bears spines, and the most important characteristic is the fact that these species are all directed away from the shaft, and do not arise perpendicularly.

Some doubt seems to have arisen since the time of Kölliker as to the exact nature of the "club," and this dubiety accounts for the original inclusion of the species *spiralis* in the genus *Juncella*. Hickson (op. cit.) describes a form of spicules as a club (pl. viii. fig. 8), but it is a club essentially different from Kölliker's type.

The spiculation as a whole is quite unlike that of any species of *Juncella* (op. cit., figs. 14, 23, and 26), so that it is impossible to refer the present specimens to that genus. They are even further removed from *Scirpearia* and *Nicella*, so that it seems necessary to form a new genus to include them.

Diagnosis of Hicksonella g. n.

Colony simple, flagelliform, and generally twisted in a more or less open spiral at least in the older colonies. The axis consists of concentric laminae which are composed of a horny substance impregnated with some form of calcareous matter. It is generally hard, and the surface is marked by longitudinal ridges and furrows.

The cœnenchyma is extremely thin and densely spiculose; it is very brittle, especially when dry. The polyps are disposed in a broad longitudinal band; this leaves a narrow bare strip which traverses the whole length of the colony. The verrucae are not retractile into the cœnenchyma, and are elongated, slender and slightly club-shaped in the upper portion; they are covered with minute spicules, which appear like overlapping scales; the spicules on the aboral surface of the tentacles form a sort of pseudo-operculum to the partially retracted anthocodia.

The spicules vary in the different species, but the following are the chief types:—(1) Irregularly warted spindles; (2) flat, smooth, or slightly warty scales; (3) large irregular forms; (4) crosses; and (5) bi-rotate forms.

SPECIFIC DIAGNOSES.

Hicksonella spiralis (Hickson) = *Juncella spiralis* Hickson.

Colony unbranched; in the larger forms spirally twisted. The cœnenchyma is thin and densely packed with scale-like spicules; the axis is composed of concentric laminae of a horny substance,

in which a calcareous deposit is embedded. The polyps are restricted to a region occupying two-thirds to three-fourths of the circumference of the cœnenchyma; a longitudinal bare tract occupies the remaining part. The verrucæ are long and club-shaped, and are evidently not retractile into the cœnenchyma; they are closely packed together, and are covered with minute overlapping, scale-like spicules. The flat thin scales on the aboral surface of the tentacles forms a sort of pseudo-operculum to the partially retracted polyp.

The chief types of spicules are (1) in the cœnenchyma very thick spindles with close-set irregular warts, passing by gradual transitions to almost spherical warty forms; (2) in the polyps (*a*) long thick spindles with few long warts; (*b*) irregular forms and crosses; (*c*) small flat thin scales.

Hicksonella flagellata sp. n.

Elongated filiform colonies which, at any rate in the younger specimens, have only a trace of a very open spiral structure. The cœnenchyma is extremely thin and densely spiculose. The axis is horny and calcareous, and is composed of concentric laminae. The polyps are confined to a broad longitudinal band occupying about two-thirds of the circumference. The verrucæ are elongated and club-shaped, and are not retractile into the cœnenchyma. The spicules are exceedingly minute, and very characteristic. They consist for the most part of (1) thick massive, warty spindles; (2) peculiar, bilaterally symmetrical forms, with a sort of thick foliaceous expansion; (3) bi-rotate forms (like those in the *Suberogorgia verriculata*); and (4) scales.

Hicksonella capensis sp. n.

Colony elongate, simple, and irregularly twisted in a spiral manner. The cœnenchyma is thin, and very spiculose. The axis is composed of concentric horny and calcareous laminae. The polyps are disposed in a broad longitudinal band; they are very long, slender, and slightly club-shaped; they are covered with small spicules transversely arranged, and are not retractile into the cœnenchyma. The spicules consist of (*a*) short, slightly warty spindles; (*b*) longer, and more warty spindles; (*c*) irregular forms; (*d*) flat, irregular scales; and (*e*) crosses.

Distribution.—(1) Geographical. All three species were found off the east coast of South Africa, and therefore their inclusion in the Family Gorgonellidae does not extend the distribution of that family.

H. spiralis. Off Cape Morgan.

H. flagellata. Off Cape Morgan.

H. capensis. Red Cliff, south of Morewood Cave, Natal.

(2) Bathymetrical. This genus, like other Gorgonellids, is represented by shallow-water forms; *H. spiralis* was dredged in 36 and 47 fathoms, and *H. eapensis* in 37 fathoms.

NOTE ON THE GENUS.

Before leaving *Hicksonella*, however, it may be of interest to consider some of the more characteristic features, for example: (1) the distribution of the verrucæ, and (2) the spiral form. Professor Hickson (ii. p. 232), has drawn attention to these, and has put forward several suggestions as to their possible origin, so that, before taking each in detail, we shall quote his observations in full, and so obviate any possibility of misinterpretation which might result from detached references.

“This bare track, i.e. the part devoid of polyps, is seen in some other species of *Juncella*. In the description of *J. junecea*, from the Isle of Bourbon, Milne-Edwards and Haime state that the calices leave some trace of a median cœnenchymatous space. Ridley also states that there is a distinct groove in the specimen of *J. junecea* obtained by the ‘Alert.’

The squamate armature of the verrucæ shows some affinities with the characters of the Primnoïdæ, but, as the plate-like spicules are so small and there are no definite opercular plates, its affinities with *Juncella* are closer. It is noteworthy, however, that in the Primnoine genus *Calypterinus* the calices do not occur on one side of the stock. The track which is free from the calices in *Calypterinus*, however, is covered by the overlapping scales of the lateral calices so as to form a tube. These bare tracks on one side of the stock in *Juncella spiralis* and *Calypterinus allmani* have a certain resemblance to the bare tracks on one side of the smaller branches of some forms of *Solenocaulon*, and suggest the presence of symbiotic Crustacea. There is no evidence in support of this at present, but it would be worth the trouble of any naturalist, who has the opportunity of dredging in these waters, to note the character of any Alpheidæ or other animals that might possibly live with this *Juncella*. Dr. Gilchrist’s note that nothing was found around which the stock twisted, is of the nature of a support for the suggestion that the spiral form of the larger stocks is associated with the presence of some epizoic animal. We may, for the present, regard the spiral form and the bare track as characters of the species, but if they prove to be mere adaptations to an epizoic animal their importance must be considerably discounted.”

The question of the nature of the bare tract is of more than passing importance, for if, as Professor Hickson suggests, it is due to some epizoic animal, it must be discounted in any question of a taxonomic nature. A study of the species which he has named along with some others of a similar character, may, however, help

to suggest another possible explanation. For this purpose let us consider the following species:—

1. *Juncella juncea*.
2. *Scirpearia flagellum*.
3. *Suberogorgia köllikeri*.
4. *Lophogorgia lutkeni*.
5. *Juncella trilineata*.
6. *Scirpearia quadrilineata*.
7. *Calypterinus allmani*.

Juncella juncea and *Scirpearia flagellum*, in common with all other Juncellids, except *Juncella trilineata* and *Scirpearia quadrilineata*, have the polyps disposed in two longitudinal series separated by two diametrically opposite longitudinal bare tracts.

In *Suberogorgia köllikeri* the polyps arise from all parts of the stem and branches, with the exception of a narrow, often wavy, portion on either side of the cylindrical axis.

In *Lophogorgia lutkeni* the polyps are numerous and occur on both sides of the stem and branches; the central portion of both the main stem and branches on both surfaces are destitute of polyps.

Again, the stem and branches are flattened in the plane of branching and are marked on the flat sides by a narrow winding groove or furrow, which is continued along the flattened surfaces of the secondary branches. The polyp-bearing surface is divided into two lateral bands by means of the two grooves.

In *Juncella trilineata* polyps arise in three different bands, leaving three narrow bare strips, each of which has in its centre a slight rib or keel.

In *Scirpearia quadrilineata* the polyps are grouped in four definite longitudinal series separated by four bare spaces.

In *Calypterinus allmani* there is a bare tract on one side of the colony, otherwise the polyps occur all round.

In *Hicksonella* the verrucæ are all prominent, and arranged irregularly on two-thirds of the circumference of the stock, leaving a bare tract on one side free from verrucæ for the whole length of the stock.

A detailed discussion of the question under consideration with regard to the various species of Juncellids has been given in the "Revision of the Gorgonellids," so that it is only necessary here to recapitulate the conclusions which have been there stated.

1. In all species of Juncellids, so far known, the polyps are disposed in a certain number—two, three or four longitudinal series which are separated by a similar number of bare tracts. This number is constant for the species.

2. There is always a definite number of nutrient canals larger than the others, which are known as the main longitudinal canals.

3. These main canals always correspond in number and position to the bare tracts.

In *Suberogorgia köllikeri*, also, the longitudinal bare strips denote the position of the two longitudinal canals much larger than the others. The same holds true in the case of *Lophogorgia lutkeni*.

In all the species so far described the cœnenchyma is moderately thick, and it has been possible to verify these points by means of transverse sections, but unfortunately the extreme thinness and the densely spiculate nature of the cœnenchyma in *Calypterinus allmani* and *Hicksonella* have rendered it impossible to determine, so far, whether any main longitudinal nutrient canals exist. Is it not possible, however, that in these species, as in the others cited, the occurrence of a bare tract throughout the entire length of the colony may be an outward manifestation of internal morphological structure, and that it corresponds to the position of a single main longitudinal nutrient canal?

If this be so, there exists in Juncellids a complete series from one to four main canals, thus:

- | | |
|--|--------------------|
| 1. <i>Hicksonella</i> sp. | One main canal. |
| 2. <i>Juncella juncea</i> , etc. | Two main canals. |
| 3. <i>Juncella trilincata</i> | Three main canals. |
| 4. <i>Scirpearia quadrilineata</i> | Four main canals. |

Other features, however, seem to point to the unilateral symmetry being of morphological and not of mechanical origin. And in this connexion the spiral nature of the colonies must be considered. It will be seen from the descriptions of the three species given in this paper that two of these are spirally twisted, and also that the spiral arrangement does not commence at the very base, but at a considerable distance from it. In the third species the colonies are all small, and it is possible that they, later on, might have developed the spiral form.

An analogous case is seen in several Antipatharia in which the polyps have morphologically a unilateral disposition. In the waters around the Mergui Archipelago and also on the reefs on the East Coast of Africa, we have had occasion to examine a large number of spirally twisted colonies, and in no case was any form of support found. Now in the majority of these cases and also in the larger colony of *Hicksonella spiralis* examined, if any rigid support existed it must also have been spirally twisted, as will be evident from fig. 1, so that it is extremely improbable that these specimens could have been detached from such a support before being brought to the surface of the water. Even if that were possible and had actually happened, it would, of necessity, have caused considerable damage to the colony. No such evidence of fracture is to be seen on any specimen.

On the other hand it is difficult to imagine how the spiral effect could be produced by free living animals, such as Crustaceans,

when we take into consideration the enormous differences in the sizes of the spirals as seen in *Hicksonella spiralis* and *Hicksonella capensis*.

If then, the morphological origin of the unilateral disposition of the polyps be admitted as possible, an explanation of the spiral form assumed by such simple Alcyonaria and Antipatharia may exist on this basis. In colonial Cœlenterates the rate of growth in the region of the polyps is always far in excess of that in the non-polyp-bearing cœnenchymatous portion. This, in part, accounts for the flabellate colonies so often met with in Alcyonaria, but completely explains the flattening of branches of species with bilaterally disposed polyps. On the other hand, in large bushy Alcyonaria and Antipatharia it is always found that the polyps are directed outwards, so that the unilateral growth finds expression in all directions. In other words, the effect of the unilateral growth in one series of branches is neutralized by that in other series of branches growing in opposite directions.

Let us now consider the case of simple colonies.

1. In those whose polyps are disposed in four series, the growth is in four directions in two planes at right angles to one another, e.g. *Scirpearia quadrilincata*, and these consequently neutralize one another.

2. In *Juncella trilincata* the growth is in three directions, each of which encloses equal angles with the other. These also neutralize one another.

3. In other Juncellids the polyps arise in one plane, and are therefore situated diametrically opposite, and the colony is there still symmetrical.

4. If, however, the polyps all arise on one side, the growth is greater in that direction than in the other, and as the support in all these cases is originally central, this will naturally result in an overbalancing of the colony.

Is it not possible that, in maintaining symmetry in the colony, and also in endeavouring to expose the polyps equally to the food supply (a feature seen in all colonial organisms), this excessive growth might find expression in a spiral form (see pl. XIII. fig. 1)?

LITERATURE CITED.

1889. WRIGHT, E. P., & TH. STUDER—Report on the Scientific Results of the Voyage of H.M.S. 'Challenger' (Zoology) xxxi. Alcyonaria.
 1904. HICKSON, S. J.—Alcyonaria and Hydrocorallinæ of the Cape of Good Hope. Part II. Marine Investigations in South Africa, i. No. 5, pp. 67-96 (6 pls.).
 1905. THOMSON, J. ARTHUR, & W. D. HENDERSON—Alcyonaria. Ceylon Pearl Oyster Fisheries Report, Roy. Soc. London, pp. 271-328 (6 pls.).
 1910. SIMPSON, J. J.—Revision of the Gorgonellidæ. I. The Juncellids. Proc. Roy. Irish Acad., August 1910.

XV.—*On the Recent and Fossil Foraminifera of the Shore-sands of Selsey Bill, Sussex.*—VI. *A Contribution towards the Etymology of Massilina secans (d'Orbigny sp.).*

By EDWARD HERON-ALLEN, F.L.S., F.R.M.S., and
ARTHUR EARLAND, F.R.M.S.

(Read October 19, 1910.)

THE more than merely superficial student of the Foraminifera comes rapidly to the conclusion that familiarity with the robust and conspicuous, and above all exceedingly common shells of *Massilina secans* has bred for it a species of contempt. Certainly no Rhizopod has had greater liberties taken with its name, and from its original appearance as *Fruventaria seminula* (Soldani) in 1795, through *Quinqueloculina* (d'Orbigny) in 1826, *Miliolina* (Brady) in 1884, *Sigmoilina* (Schlumberger) in 1887, to *Massilina* (Schlumberger) in 1893, under which generic name it is now enjoying a brief rest, it has been the prey of the species-monger or "splitter." It is undoubtedly, as we have had occasion to remark elsewhere, the commonest of all British Foraminifera.* It is by no means a rare thing to find stretches of sand upon our southern, and probably other, coasts, strewn with a thick deposit of pure Foraminifera extending for a mile or more, and many yards in breadth, ninety-five per cent. or more of which is entirely composed of *Massilina secans*. At Dog's Bay, in Connemara, its shells are blown up from the beach, with a small intermingling of other species, in such vast quantities as to form extensive banks or dunes high up on the shore, thus forming a true organic sub-aerial deposit. It is, therefore, the more remarkable that, as far as we know, there is no published record of its occurrence east of Bognor, where it was recorded by Earland,† or, south of the Orkney and Shetland Islands (where it has been found by Earland during the cruises of the Fisheries Commission steamer 'Goldseeker') on the east coast of the British Isles. This is recorded here for the first time, together with the fact of its occurrence in the shore-sands at St. Andrews on the shores of Fife, N.B., and also at Kingsgate and Broadstairs, in the Isle of Thanet (Kent), where it has been found by Heron-Allen. In view of the enormous quantity in which the species is found, it is not remarkable that it is liable to extraordinary eccentricities of form,

* Knowledge, xxxiii. No. 505 (Aug. 1910) p. 304.

† The Foraminifera of the Shore-sand at Bognor, Sussex. Journ. Quekett Micr. Club., Nov. 1905, p. 187.

and that it has tempted students of the family to separate its eccentricities under varietal names. In the year 1889 Mr. Edward Halkyard, F.R.M.S., thus differentiated a variety having strongly marked transverse striæ, which he described and figured under the name *Sigmoilina secans* var. *obliquistriata*.* It is true that in 1891 he reconsidered the advisability of so distinguishing it, and abandoned the varietal name.† In the year 1856, Costa proposed the specific name *denticulata* for specimens the outer periphery of which was more or less strongly carinated, or keeled, the carination being scalloped into points almost as pronounced as those of *Cristellaria calcar*, or those that are characteristic of the early stages of *Polystomella crispa*.‡

Earland found Costa's variety in the shore-sands of Bognor, Sussex, and figured it in the paper already referred to, and in the same sands he found, and in the same paper recorded, a striking and very recurrent variety distinguished by fine hair lines, or striæ, running closely together, parallel to the long axis of the outer chamberlets of the shell. To this variety he gave the name *tenuistriata*.

In March of this year (1910) a large tract of the shore of Selsey Bill was strewn half an inch thick with a pure deposit of foraminiferal shells, the vast majority of which were those of *Massilina secans*. We have devoted a great many hours to the examination of this deposit, and have found in it almost every eccentricity and monstrosity of form of which the genus *Miliolina* is capable (which is saying a good deal), but we never found any sign of the three varieties which we have just described. Exhibited upon the table are two slides, one containing peculiarities of form or marking, together with Miliolids other than *Massilina secans*, and the other containing absolute monstrosities from this deposit of last March. In April, however, we made an expedition to the Mixon Reef and Beacon, some two miles out at sea from the point of Selsey Bill, and made a gathering of mud and sand from the algæ adherent to the rocks, with a view to studying the life-history of the common British Foraminifera, and this gathering is still under observation. Some of the results of those observations, regarding *Massilina secans* and *Polystomella crispa*, have already been published elsewhere;§ the further results we hope to place before this Society at an early date. The gathering was stored in narrow observation-tanks, and is continually examined by means of a Zeiss-Greenhow binocular Microscope, constructed for us

* E. Halkyard, Recent Foraminifera of Jersey. Trans. and Ann. Rep. Manchester Micr. Soc., 1889, p. 61, pl. I. fig. 7.

† E. Halkyard, A Comparative List of the Recent Foraminifera of the Islands of Guernsey, Hérn, and Jersey. Trans. and Ann. Rep. Manchester Micr. Soc., 1891, p.

‡ *Quinqueloculina denticulata* Costa, 1856, Atti Acad. Pontaniana, vii. fasc. 2, p. 325, pl. xxv. fig. 6 a, b, c.

§ Knowledge, loc. cit.

by Mr. H. F. Angus, and the observations recorded. In September, the number of shells in the tanks having greatly increased (though we must confess that we have never been able to observe the actual processes of reproduction), we washed out the contents of two of the tanks for examination. We were astonished to find that the majority of the shells of *Massilina secans*, the principal denizen of our tanks, were more or less distorted or idiosyncratic. Among the dried and floated shells we found all three of the varietal forms above described, and not only was this the case, but we found them in extraordinary combinations: var. *denticulata* also *tenuistriata*, var. *tenuistriata* also *obliquistriata*, and there is one shell on the slide exhibited this evening which exhibits all three variations, so that it might be referred to as *Massilina secans*, var. *denticulata-tenuistriata-obliquistriata* d'Orbigny-Costa-Earland-Halkyard!

It must be borne in mind that these shells were grown under peculiarly starved conditions. The tanks measure on an average 5 in. by 6 in. in height and breadth, and have a diameter from back to front of only $\frac{3}{4}$ in. It is therefore obvious that the supply of carbonate of lime and other salts at the disposal of the Foraminifera born in the tanks is very limited, for it must be remembered that these observations have been carried on in London, and the sea-water has never been renewed. It has been kept sweet by the growth of green algæ, which oxygenate the water, and evaporation has been compensated by the addition of fresh-water from time to time when the specific gravity bulbs warned us of increasing salinity.

We are therefore led to the conclusion that these varietal markings, in *Massilina* at any rate, are nothing more than the effect of the animal having to live under starved and unnatural conditions, and it will be interesting to see whether the same tendency to variation will be exhibited by other species grown under similar conditions.

The curious monstrous forms, of which a number of specimens are exhibited, are usually the result of damage. It is difficult to surmise to what dangers of damage *Massilina* may be exposed when clinging to rocks or algæ, but it seems indifferent to casualties. We have frequently, in the attempt to dislodge a shell for closer examination, smashed the ultimate or penultimate chamber. In the former case the pseudopodia were soon extended from the point of fracture, and in the latter from the end of what would have been the last chamber if its growth had been checked at that point, and it is a common thing to find a *Massilina* whose shell has been broken, repaired by the secretion of a new shell over the protoplasm protruded at the point of fracture.

XVI.—*A Micrometric Difficulty.*

BY EDWARD M. NELSON.

(Read October 19, 1910.)

SOME, in the ordinary course of their microscopical work, may have found, as I have, no little difficulty in counting the correct number of ruled lines, or of diatomic striæ, in a given space.

For example, a count of 16 may be made; the next count may yield 17; subsequent counts may oscillate between 16 and 17; so in despair the observer will take the mean and call it $16\frac{1}{2}$, well knowing that actually there must be either 16 or 17—which of the two he cannot tell.

This trouble does not arise when the interspace appears relatively wide with respect to the breadth of the line, but it is sure to do so the moment the breadth of the interspace appears approximately equal to that of the line. Some difficulty may be experienced in counting Grayson's 20,000 band with a low-angled $\frac{1}{2}$, but none with an oil-immersion $\frac{1}{2}$; nevertheless, the phenomenon has been observed with a band as low as 30,000 per in. and an oil-immersion $\frac{1}{8}$. It is rather humiliating to think that in this twentieth century there should be any difficulty in counting what may be tolerably large microscopical intervals.

A great deal more micrometry is performed by counting a few intervals embraced between the lines on a scale in an eye-piece than by the employment of a screw cobweb micrometer; consequently, when a count consists of only a few lines, one more or less may make a considerable percentage of difference in the final result. It is not improbable that discrepancies, which some have



FIG. 104.

noted in the striation of diatoms, may be due to this cause, but it does not appear that anyone has given an explanation of the cause of this phenomenon. In brief, it is the black-and-white dot image that is responsible for all the trouble. Thus, let fig. 104 represent 4 lines, or striæ, at black-dot focus, obviously then the lines count 4. When, however, the focus is slightly raised, the lines become a white-dot and the spaces a black-dot image, and the count is but 3.

Measurements by a screw cobweb micrometer are free from error on this score, for obviously it cannot matter in the least whether the image is at white- or black-dot focus; but when a count is made between the fixed lines in a micrometer eye-piece, great care should be exercised. In other words, the fineness of a

ruled band may be accurately measured, but the number of lines ruled may not be determined.

Having found the cause, the next thing is to discover a remedy. It is very simple when pointed out, for it is only necessary to remember that when the lines are at a white-dot focus, the white and not the black lines must be counted. Unless the microscopist keeps a sharp look-out, a mistake may be very easily made. The merest touch of a delicate focus will shift the image from a white to a black dot, and it will depend upon the point of correction of the object-glass (i.e. tube-length) whether the white- or black-dot image is the stronger of the two, or whether both are alike. The determination as to whether the image is a white- or a black-dot one is not quite so easy as one would suppose. The best advice is to use a large W.A., and be on your guard.

XVII.—On the Resolution of New Detail in a *Coscinodiscus asteromphalus*.

BY EDWARD M. NELSON.

(Read October 19, 1910.)

ADDITIONAL work with the new lens, mentioned in my last note,* has pushed diatom resolution on a step further. Not only have known images of a very difficult character been more easily seen, but detail never previously glimpsed has been discovered. This new detail is a fine sieve covering the eye-spot of a *Coscinodiscus asteromphalus*. It will probably be considered sufficiently important to be recorded, because it may be said to complete this diatom, and constitute it the first diatom of its class whose form is fully known, so that an enlarged model of it might be made.

The simplest forms of diatonic structures seem to be those of the *Isthmia*, *Biddulphia* class, which have single walls with areolations covered by a sieve membrane. A model of an *Isthmia* might be made out of a leather cigar-case by making holes in it with a gun-wad punch and covering these holes with gauze; a protuberance open at the top, also covered with gauze, must be made at opposite corners. The *Coscinodiscus asteromphalus*, however, consists of a polygonal cell-like structure (fig. 105, A) not unlike honey-comb, the top of these cells being covered with circular or oval-shaped caps (B).†

These caps have at their peripheries a circlet of large circular perforations, each of which is closed by a very fine sieve membrane.‡ In the space inside this circlet is another sieve membrane with a larger mesh. At the bottom of the cells or honey-comb is a plate having a hole, known as the "eye-spot," in the centre of each cell (A and C).

The true form of this hole, or rather short pipe, was described by Mr. H. Morland at the Quekett Club.§ It is on the lower end of this pipe that the new sieve membrane has been discovered (C).

* Page 147 *ante*.

† Fig. B is diagrammatic, the spots in the peripheral circles are small, but not quite as small as those in C. The next inner circle of black dots should be represented about the same size as those at present in the peripheral circles and like them of irregular shape. They are the exterior holes of the central sieve pattern.

‡ Journ. Quekett Micr. Club, vii. ser. 2 (1898) p. 81, pl. viii. fig. 8. This very fine sieve is the membrane described in my previous note as being seen for the first time in a balsam mount.

§ Op. cit., iii. ser. 2, p. 79, and for illustrations see Trans. Middlesex Nat. Hist. Soc., 1889, photo plate, fig. 2 (see No. 46 in list).

A membrane closing the pipe had been seen by me upwards of twenty years ago, but its sieve-like nature was not recognized, neither was it thought to be present in each pipe, but was regarded as an anomaly. It is so diaphanous that its presence was only perceived from an edge in a broken specimen. It is not improbable that the office of all these sieve membranes in diatoms generally is to guard the internal protoplasm from bacterial attack, and at the same time to allow water to freely circulate. The bore of this pipe measures, with antipoint correction, $\frac{1}{14600}$ in. = 1.74 micra, so the fineness of the holes in the sieve covering it can be imagined ; it forms an interesting speculation as to what size of hole a diatom considers it unnecessary to cover with a sieve membrane. We have advanced

some way since diatoms were said to be the fossil shells of Infusoria, and their imperfectly resolved structures were thought to be the ridges and corrugations on those shells. The biologists of those days were so fully occupied with the outward shapes of these newly discovered organisms that the only thing they cared to know was whether it was elongatum or attenuatum, minutum or parvum, grande or major. As all this quite unimportant detail could be determined and surface markings, which did not exist, be seen with Dr. Ehrenberg's cheap and inefficient Microscope, it was thought that a better Microscope, or an instrument of the highest precision, was quite unsuitable for biological purposes. We now know that Nature's deep secrets are not only beyond our unassisted vision, but are also far beyond our most powerful Microscopes, and the Microscope necessary for biological work has not yet been and probably never will be made, for there will always be a something beyond what we can either see or understand.

Diatoms are now known to be of great importance, and to have a profound influence on biology, for it is diatoms which, living on inorganic chemical substances in the sea, incorporate those substances in their bodies, and change them into such a form that they can be assimilated by the minute Crustacea and Copepods that eat diatoms. The Crustacea are the food for higher fishes, and so on ; the question now becomes one of economic importance, for if we want to increase the number of edible fish, we must increase the number of diatoms. What do we really know about diatoms ? Very little indeed ; their life-history and

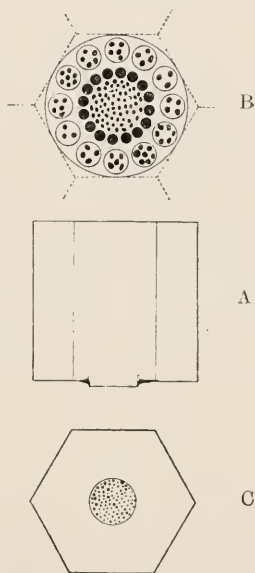

FIG. 105.

manner of movement is practically a sealed book ; what is wanted is a more powerful Microscope.

If these tubules through the silix are at the rate of 60,000 per inch, and if their diameters are equal to the interspaces between them, then the diameter of each tubule will be $\frac{1}{120000}$ in. or 0.2116 micron.

Now, assuming that the length of the tubule is four times its diameter, its volume is so small that it would take 1381 years to count the number that could be packed in a box 1 c.mm. in size, counting 100 per minute and working 10 hours a day, 10 p.c. being allowed for the interstices in packing cylinders in a cube. We are apt to talk volubly about 1000 and 2000 diameters, and what we can see with those powers, without in the least realizing what we are actually talking about.

It is not so long ago that the Government, following the example set by Geneva, instituted a laboratory at Kew for the purpose of testing the rates of watches. According to their performance, watches are divided into three classes—A, B and C—and “especially good” is added to the certificate of a watch obtaining a high percentage of marks in its class. We have not yet got as far as this with our Microscopes, whatever we may arrive at by-and-by ; in the meantime, I would not put any Microscope into Class A unless it would demonstrate the sieve membrane on the process of an *Auliscus sculptus* mounted in balsam. This is an excellent test for several reasons. The diatom is not rare ; a balsam mount is easily obtained, and is durable ; the sieve does not vary much in strength ; the test cannot be resolved by a narrow beam of oblique light in one azimuth, but it requires a large axial cone to demonstrate it. It is sufficiently delicate to test not only the objective, but also the eye-piece, the condenser, the steadiness of the stand, the quality of the fine-adjustment, and the keenness of the observer's sight ; but some more difficult test than this would be necessary for an “especially good.”

NOTE.

Grayson's Photomicrographs of his Rulings.

By EDWARD M. NELSON.

PLATE XIV.

IN Grayson's beautiful photographs, exhibited at the Meeting on June 15, there are points of interest which deserve special notice. Pl. XIV. fig. 1 is a reproduction of his photomicrograph of his own 90,000 band, amplified 1930 diameters, and pl. XIV. fig. 2 is a copy of his enlargement of his own negative, in which the total amplification amounts to 7750 diameters.*

It will be apparent to everyone that by any examination of the photomicrograph (pl. XIV. fig. 1) it is quite impossible to determine the number of the lines Grayson has actually ruled in that band, because no one can tell where the ruling begins or where it ends. The band has been photographed by oblique light; on the left-hand side, at *a*, fig. 1, there is a very dark broad line, and next to it a thin faint one, and upon the other side of the band, at *c*, the lines fade off in three or four "ripples." In pl. XIV. fig. 2 Grayson has cut off the "ripples" at *d*.

It does not appear that these phenomena have been noticed by anyone, but, be that as it may, no account has been published either of them or of the source of their origin. Both the strong and the faint lines and the "ripples" owe their presence to oblique illumination in one azimuth, and are examples of the "diffraction phenomena" usually present with that kind of illumination. When ruled lines and diatomic striæ are examined by oblique light in one azimuth, two images can be produced (these are usually perceived at once, if not, a little special manipulation will always cause them to appear): the one image is that of the band or diatom unresolved, the other is that of the resolved lines or striæ, which seemingly float over the unresolved band. In brief, they are examples of Professor Abbe's absorption and diffraction images. Now the law in respect to these images is this: upon focal alteration the upper, or diffraction image will roll over the lower, or absorption image. (The word roll precisely describes this phenomenon, which is exactly like that of the roll-top of an escritoire: the lines appear to

* These amplifications refer to the reproductions which differ but slightly from the original prints.

shut up on one side and roll out upon the other.) When the focus is raised, the "ripples" always advance towards the incident light.

If, therefore, Grayson's photomicrograph was taken with the focus slightly raised, then the light was coming in a direction from right to left, but if depressed, in the opposite direction.

Whether the image of the lines or striæ is stronger with an elevated or depressed focus will depend upon the correction of the object-glass, i.e. tube-length. Now let it be assumed that Grayson had such a length of tube that the stronger image was obtained with a slightly depressed focus, in which case the light will be coming from left to right, and the "ripples" running away from it, as at *c* (pl. XIV. fig. 1).

At *a* the lines will be rolling up, and it may be assumed that they have rolled up as far as the right-hand edge of the left-hand border of the absorption image of the band.

The absorption image of this edge will consist of a black line with its complementary white lines on either side of it.*

We have then an absorption black line of the border of the band, and on top, and rather to the right of it, the first diffraction line of the ruling; these two reinforce each other and originate the wide black line seen at *a* and *b* (pl. XIV. figs. 1, 2). The second line of the ruling falls on top of the white border of the absorption line, and, being weakened, appears as a faint line to the right of the broad black line.

At *c* (pl. XIV. fig. 1), on the other side of the band, are the "ripples," which are running off the lower right-hand absorption band, and the farther off they get the weaker they become. Also at *c* a rather wide white line followed by a blacker line may be detected; these are due to the influence of the border of the absorption band underneath them. I do not know the reason why the same phenomena on the right hand at *c* should be so much less pronounced than they are on the left hand at *a* (pl. XIV. fig. 1).

If a photomicrograph of ruled lines is taken by a direct axial cone of wide angle—that is, if the illumination is critical—the print will truly represent the original. Thus pl. XIV. fig. 3. represents one of a band containing 34 ruled lines; but the moment oblique light in one azimuth is used the image may no longer reproduce the original, the rate of ruling only excepted. In other words, while it is possible in an image of rulings obtained by oblique illumination to determine the rate per inch of the ruling,

* Another example of an interference phenomenon. These white lines are of necessity not easy to detect, because they are viewed upon a bright field, but they are often to be found in photomicrographs on account of their exaggerated contrasts. But even in the Microscope, when looked for with attention, they may be seen; at the same time, it is quite easy to overlook them.

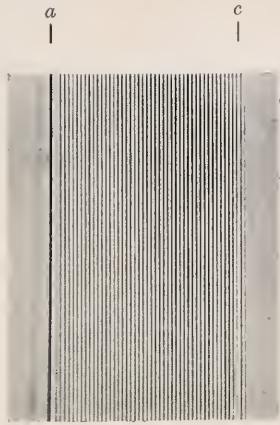

FIG. 1.



FIG. 2.



FIG. 3.

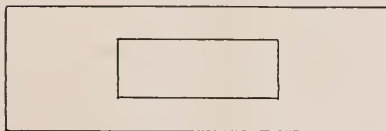
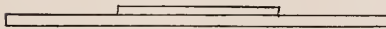

FIG. 4.

it is not always possible to correctly count the number of lines actually ruled.*

In practice it is important so to adjust the object-glass, either by collar or tube-length, that the strongest image is formed before the upper diffraction image has begun to roll.

Together with these photographs, Grayson has sent some additional examples of his beautiful rulings. They consist of a whole inch divided into hundredths, and they are ruled upon glass, quartz, silver film, and speculum metal.

The material which contains the ruling is in the first three attached to an ordinary 3 by 1 glass slip, but that upon speculum metal is attached to a 3 by 1 brass slip.

Pl. XIV. fig. 4, drawn to a scale of two-thirds, shows the manner in which they are mounted.

The rulings upon glass are similar to those upon ordinary micrometers, but the lines are much finer in that ruled upon quartz. The lines on the metallic plates, when a strong light is thrown upon them, look like very fine incandescent wires.

These new rulings will be found to be useful for a variety of purposes; for example, shortly after their arrival a particular divided lens-micrometer was calibrated, which would not have been so easily done without their aid.

* Upon numerous occasions I have counted one more line with oblique than with axial large cone illumination, even when the adjustments were as perfect as possible. It would seem that to have one more line than actually exists is a normal condition of oblique light resolutions.

SUMMARY OF CURRENT RESEARCHES
RELATING TO
ZOOLOGY AND BOTANY
(PRINCIPALLY INVERTEBRATA AND CRYPTOGAMIA),
MICROSCOPY, ETC.*

ZOOLOGY.

VERTEBRATA.

a. Embryology. †

Organogenetic Capacity.‡—H. Przribrum discusses the organogenetic capacity of various parts of the body in diverse types. The Metazoa have, like crystals, a certain polarity in the direction of growth, but they have also a kind of polarity of stratification, chemically different substances occurring in zones from in front backwards.

One part of an animal can produce only what corresponds to its strata, which again are laid down in development. When materials circulate, there may be a modification of the polarity of stratification, and the polarity of growth may be also reversed. Ovum-regulation and regeneration of parts must be interpreted on similar principles.

Inheritance of Quantity and Quality in Cows' Milk.§—James Wilson submits the results of a statistical inquiry showing the separate inheritance of quantity and quality in cows' milk. "If we group together all the low-yielding cows, and find their milk invariably high in quality, we may infer that low yield and high quality are of the nature of concomitant variations. If we group the high-yielding cows together, and find their milk invariably of low quality, we may infer that high yield and low quality run together. But if we take these groups and any other groups we can form, and find that the quality varies in the same way in them all—that is, that there are low qualities, high qualities, and medium qualities in every one of them—then we are justified in inferring that the quantity and quality of the milk are independent of each other. And this is what we do find."

* The Society are not intended to be denoted by the editorial "we," and they do not hold themselves responsible for the views of the authors of the papers noted, nor for any claim to novelty or otherwise made by them. The object of this part of the Journal is to present a summary of the papers *as actually published*, and to describe and illustrate Instruments, Apparatus, etc., which are either new or have not been previously described in this country.

† This section includes not only papers relating to Embryology properly so called, but also those dealing with Evolution, Development, Reproduction, and allied subjects.

‡ Ver. Zool. Bot. Ges. Wien, lx. (1910) pp. 111–16.

§ Sci. Proc. R. Dublin Soc., xii. (1910) pp. 470–9) 6 figs.

Heredity in Connexion with Cancer.*—L. Cuénot and L. Mercier have studied in mice the question whether susceptibility to cancer-grafting is heritable. The character of susceptibility or refractoriness is not Mendelian. Some families show a large percentage of susceptibility, some a small percentage. The progeny of two cancerous parents in a "poor line" are more likely to exhibit tumours than the progeny of two refractory parents in a "rich line." "In the problem of cancer, already so complex, it is undoubtedly necessary to make room for a heredity-factor."

Engrafting Tissues.†—C. C. Guthrie placed fragments of gonads of fowl beneath the skin, or in the peritoneal cavity. When engrafted in close proximity to large blood-vessels, ovarian tissue made a good growth in chickens. Engrafted testicular tissue contained numerous spermatozoa. Results of exchanges of such tissues between the sexes, as well as between different species, have thus far been negative, but it would be premature to draw conclusions. A lobe of thyroid was reversed in a dog; in two years it was markedly fibrous, and while it showed normal elements, the proportions and arrangements were abnormal. An engrafted kidney in a cat became very fibrous, and only a reminiscence of normal renal structure remained.

Engrafting Gonads.‡—C. C. Guthrie has effected auto-intra-abdominal and subcutaneous grafts of ovaries in fowls. The transplanted ovaries function. Engrafted testicular tissue shows a marked growth and normal structure almost four months after the operation, but no offspring have been as yet produced from engrafted testicles.

The general effect of removing ovaries is, as is well known, a sub-normal development of female characters. The influence on development may be so strong that on reaching adult age the unsexed animal may present qualities as strongly masculine as feminine. No such result was observed in hens into which ovaries were engrafted after removal of their own ovaries, except in one case, when degeneration of the engrafted ovary occurred. The results in this case were very pronounced. "The pullet acquired not only the outward anatomical features of a cock—cock's comb, wattles, long hackle and tail feathers, rapidly developing spurs, carriage, etc.—but the behaviour as well was that of a male; it exhibited a pugnacious attitude towards other cocks, was attracted by hens, and even went so far as to tread hens as a cock."

Guinea-pig Graft Hybrids.§—C. C. Guthrie removed the ovaries of a young guinea-pig, and in the former site of the right ovary the left ovary from a sister guinea-pig was engrafted. The guinea-pig afterwards gave birth to two young.

Castle || has also reported the birth of two guinea-pigs from a spayed white mother, carrying engrafted ovaries from a black guinea-pig and bred to a white male. He states that no evidence of foster-mother influence was exhibited, but Guthrie points out that no such evidence

* Comptes Rendus, cl. (1910) pp. 1443-6.

† Proc. Soc. Exp. Biol. and Med., vii. (1910) pp. 43-5.

‡ Journ. Exp. Med., xii. (1910) pp. 269-77 (2 pls.).

§ Science, xxx. (1909) pp. 724-5.

|| Tom. cit., pp. 312-13.

was to be expected, since the markings of such hybrids are not uniform, and the mating was not suitable for bringing out such influence. Guthrie's results on fowls and Magnus's results on a rabbit give some indication of a "somatic" or "foster-mother" influence in the characteristics of the offspring.

Artificial Parthenogenesis of Frog's Eggs.*—E. Bataillon made a minute puncture on the eggs of *Rana fusca* with a fine needle of glass, platinum, or manganese, and a large proportion (three-fourths) segmented. About a tenth underwent gastrulation and a few developed into free larvæ. It seems that the puncture causes a change in the internal osmotic equilibrium.

Number of Chromosomes in Batrachians and in Parthenogenetic Embryos.†—Armand Dehorne finds that all the common Batrachians have twelve chromosomes, not twenty-four as is usually stated. In the anaphase of the epidermic cells of the larval salamander it is easy to convince oneself that the number is twelve; in the prophase and metaphase twenty-four are seen.

Dehorne followed Bataillon's method of inducing parthenogenesis by puncturing the eggs of the frog, and he was interested to find that the cells of embryos of 2 days and $6\frac{1}{2}$ days had only six chromosomes.

Intra-uterine Embryos of Saw-fish.‡—T. Southwell describes a large saw-fish (*Pristis cuspidatus*), $15\frac{1}{2}$ ft. long, which had twenty-three embryos (nine males and fourteen females) in the oviducts. The embryos all lay horizontally, parallel to the axis of the parent, each about 14 in. long, including a rostrum of 5 in. The dentition on the rostrum was quite apparent, but was entirely covered by a transparent cartilaginous tissue.

Influence on Nervous System of Extirpation of Limb-primordia in Frog Embryos.§—B. Dürken has made a number of experiments to test whether the development of the appendages influenced the development of the central nervous system. His results go to show that for a certain period of development there is a correlation. At certain stages a hindering of the development of an appendage is followed by abnormal development in the whole central nervous system.

Somatic Modifications in White Mice, and their Reappearance in the Offspring.||—F. B. Sumner, following up his earlier researches, has made a series of experiments on the effects of differing temperatures on the growth of white mice, with a view to determining whether, and to what extent, these somatic modifications reappear in the offspring. He found that mice which were reared in a warm room (about 21° C.) differed considerably from those reared in a cold room (about 5° C.) as regards the mean length of tail, foot and ear. These organs were found to be longer in the former than in the latter set of individuals. (Differences in hair were not taken into account in this experiment.)

* Comptes Rendus, cl. (1910) pp. 996-8.

† Tom. cit., pp. 1451-3.

‡ Spolia Zeylanica, vi. (1910) pp. 137-9 (1 pl.).

§ Nachr. k. Ges. Wiss. Göttingen, 1910, pp. 133-40 (5 figs.).

|| Arch. Entwickl., xxx. (1910) pp. 317-48.

The same differences were found to be manifested by the offspring of the warm-room and cold-room parents, although the animals belonging to the second generation were all reared together in a common room, and exposed to identical temperature conditions. In the experiment in question there were 141 of the warm-room descendants, and 145 of the cold-room descendants. The differences between the two sets were revealed not only through a comparison of the gross averages of the three characters in the two contrasted sets of individuals, but by a comparison between averages computed for each group, when the mice have been divided into groups according to size, and when these groups have been still further divided according to sex. By calculations of probability it has been shown that the chances for the purely "accidental" occurrence of all these variations are very slight. These differences among the offspring were manifested with fullest certainty in an early series of measurements, made at the age of 6 weeks. In a later series, made at the mean age of $3\frac{1}{2}$ months, the same relations were found to exist, though in a less striking degree. The differences are exhibited with a closer approach to unanimity by the females than by the males.

The author discusses the various interpretations to which this reappearance of the parental differences in the two sets of offspring is open. Some of these—that it may be due to "accident" or "coincidence"; to a slight unconscious bias of the caliper measurements in favour of the desired result; to the immediate effect of temperature on the germ-cells; or to the influence of temperature during pregnancy—are very briefly dismissed. But more serious consideration is given to the following possible interpretations: the differences in the length of the peripheral parts may be correlated with some constitutional difference of a very general kind in the two sets of parents. The development of one set of mice may have in some way been retarded or accelerated relatively to that of the other. Though temperature as such may not directly affect either germ-cells or foetus, it may have, even on the body of the parent, an indirect influence due to the formation of specific chemical substances, which, through the blood, might influence both body and germ-cells. Finally, changes undergone in the parent body may themselves be registered in some way in the germ-cells so as to be repeated in some measure in the next generation. The author inclines to think that the truth will be found to lie in one or both of the last two alternatives, but he maintains that no decisive verdict can be given until a sufficient number of experiments to test every possible hypothesis have been carried out. This work he hopes to be able to undertake in the near future.

Full details of the results of the present set of experiments are appended to the paper in tabular form.

b. Histology.

Nucleated Red Blood Corpuscles in Blood-vessels of the Hypophysis.*—Alezaïs and Peyron describe nucleated elements in the

* C.R. Soc. Biol. Paris, lxi. (1910) pp. 204-6.

vicinity of the endothelial walls in the human hypophysis, which have a strong resemblance to erythroblasts, especially to those of the embryonic liver.

Red Blood Corpuscles of Mammals.*—E. Retterer and A. Lelièvre have studied the development of red blood corpuscles (in connexion with the hyoidean apparatus in embryos of dog and cat), and they come to the conclusion that the corpuscle in the adult is only the nucleus, the cytoplasm having become fluid. In oviparous Vertebrates, in embryo Mammals, and in anæmic Mammals, the red blood corpuscle is a cell; in a healthy adult Mammal it is a nucleus.

Life of Isolated Cells.†—J. Jolly has observed cell-division in the red blood corpuscles of the newt in blood which had been isolated for 15 days. In a small quantity of blood taken directly from the heart and kept for 4½ months in a tube placed in ice, the leucocytes were still alive. With the blood of frog and Mammal, prolonged survival *in vitro* was also observed, but the best temperature in these cases seems to be a little above zero.

Structure of Sclerotic.‡—J. Chatin points out that while the sclerotic of Mammals generally consists of more or less dense connective tissue, there is great diversity in other Vertebrates. It may show chondrification, or even ossification. In *Platydictylus muralis* and *Gymnodactylus scaber* there is typical hyaline cartilage. In Birds there are well-known sclerotic ossicles. It is interesting to find fibrous tissue, cartilaginous tissue, and bony tissue—a related series—occurring in different types in the same situation.

Chordoid Tissue.§—Josef Schaffer discusses the nature of the tissue composing the notochord. It is not to be referred to cartilage, nor to epithelial tissue. It rather represents a supporting substance of wide occurrence and manifold forms, which may be regarded as the phyletic predecessor of cartilage. It may be called vesicular supporting tissue of the chordoid type, or, more briefly, chordoid supporting tissue. It includes diffuse and compact forms, and the general characteristics are the following:—1. It is composed of vesicular or spherical cells, whose form and elasticity are determined by the turgor-pressure of the enclosed fluid. 2. The cells have a differentiated peripheral membrane, which has increased elastic resistance as the turgor-pressure decreases. 3. The cells can be readily isolated, for there is no intercellular substance.

Structure of Bone in Sunfish.||—M. Nowikoff points out that the five different kinds of bone which Kölliker recognized in fishes do not exhaust the manifold diversity. The bones of *Orthogoriscus mola*, with their characteristic chambered meshwork, are very remarkable. Two kinds of bone-substance may be distinguished. The first forms the walls of the chambers, and exhibits a large number of Sharpey's fibres.

* C.R. Soc. Biol. Paris, lxi. (1910) pp. 19-22.

† Tom. cit., pp. 86-8 (5 figs.).

‡ Comptes Rendus, cli. (1910) pp. 185-6.

§ Anat. Anzeig., xxxvii. (1910) pp. 231-9.

|| Tom. cit., 98-106 (6 figs.).

The second occurs within the chambers, and is traversed by only a few of these fibres. In both kinds the Sharpey's fibres extend from the proper bone-mass produced by the activity of the osteoblasts. The study of the sunfish confirms the view that the chief mass of the bone ground-substance is a product of osteoblast activity.

Function of Neurofibrils.*—Albrecht Bethe discusses this much-debated question, and comes to the conclusion that in spite of all criticism the interpretation of the neurofibrils as conducting elements rests on a sound foundation. There may be greater physiological certainties, but the author puts this interpretation on the same level as that of the contractility of myofibrils, or of the sensitiveness of the rods and cones to light.

Affinities of Mammary Glands.†—L. Hoche brings forward a number of histological facts in regard to the structure of the mammary glands in health and disease, which lead him to think that their relationships are with sudorific, salivary, and lachrymal glands, rather than with sebaceous glands as is usually believed.

Role of Chondriome in Secretion.‡—H. Hoven has studied the details of the process of secretion in pancreatic cells, and his general conclusion is that the internal portion of the mitochondrial filaments gives rise to secretion-granules by a process of disintegration, while the basal peripheral portion persists as an active uniform filament which grows rapidly, and gives rise to new chondriocents capable of elaborating more secretion-granules.

Process of Secretion in Human Hypophysis.§—Alezais and Peyron describe the behaviour of the nucleus during secretion in the glandular lobe of the human hypophysis. The most interesting phenomenon is the migration of the nucleolus and its dissolution in the cytoplasm. There is often a clear halo-like zone around the nucleus which may be replaced by hernia-like prolongations of the nucleus. The nucleus, which evidently plays an active part in the secretion process, may retain its integrity, but it may also undergo karyolysis and disappear.

Peyer's Patches in Birds.||—Ed. Retterer and Aug. Lelièvre discuss the resemblance between these structures and the bursa Fabricii. In both the closed follicles are due to epithelial cells. These proliferate and are transformed into the reticular framework of the follicle and the lymphocytes in the meshes. Peyer's patches and bursa Fabricii have to begin with an essentially similar development, though the later history of the two structures is very different.

Nature of the Bursa Fabricii.¶—Aug. Lelièvre and Ed. Retterer have studied the development and retrogression of this enigmatical

* Anat. Anzeig., xxxvii. (1910) pp. 129-38.

† C.R. Soc. Biol. Paris, lxxviii. (1910) pp. 1028-9.

‡ Anat. Anzeig., xxxvii. (1910) pp. 343-51 (7 figs.).

§ Comptes Rendus, cli. (1910) pp. 94-6.

¶ C.R. Soc. Biol. Paris, lxxix. (1910) pp. 114-17.

¶ Tori. cit., pp. 169-72.

organ in birds. It arises, as is well known, in the form of a diverticulum from the cloaca. At the expense of the epithelium lining this diverticulum buds develop, which penetrate into the "chorion" of the mucosa. These epithelial buds represent the first stage of closed lymphoid follicles: the chorion corresponds to the dermis of the diverticulum, and does not share in forming the follicles. The follicles are distinctly hæmatopoietic. In a second stage the centre, and afterwards the cortical portion, of the buds undergoes transformation into reticulated tissue. Lymphocytes and blood-corpuscles cease to be formed from the epithelium; those formed are borne away in the lymph-stream or in the blood; a third adult stage is reached in which the organ is practically a mass of fibrous connective-tissue.

c. General.

Immunity of Lerot to Viper's Venom.*—G. Billard had two lerots bitten several times by large adders, but without effect apart from local inflammation and loss of hair around the bite. A young badger bitten by two very large adders, showed no ill effects.

Apparent Bactericidal Influence of Colostral Milk.†—Max Bub finds that the apparent germicidal property of colostrum milk is, in the main, due not to an actual killing off of the bacteria, but almost exclusively to an inhibition of development. The agglutinins present cause the germs to coalesce in balls.

Variation in Skull of Sea-elephants.‡—Einar Lönnberg has made a minute study of the dimensions of the skulls of *Macrorhinus*, and finds "exceedingly great variation." This is partly explained by the general rule that large Mammals, the growth of which is continued through a long period of years, each of which contains different seasons with different conditions of life, are more apt to vary than such as conclude their growth within one year. Another factor which may also be of some importance in this connexion, is that the sea-elephants originally had hardly any dangerous foes which could influence natural selection. Now, unfortunately, these very interesting and completely harmless sea-monsters are threatened with rapid extinction through human greediness.

Rabbit and Hare.§—J. F. Van Bemmelen has made a very detailed comparison of the skulls of rabbit and hare, and his conclusion is, in a sentence, that the rabbit is a transformed hare. All the differences in the skulls are correlated with differences in the mode of life of the two closely related forms.

Hairs on Mole's Hands and Feet.||—J. Kazzander has found on the proximal margin of the mole's palm a regular crescent of hairs in several dense rows. They are partly sinus hairs and partly ordinary

* C.R. Soc. Biol. Paris, lxxviii. (1910) p. 982.

† Centralbl. Bakt. Parasitenk., xxvii. (1910) pp. 321-36.

‡ Proc. Zool. Soc., 1910, pp. 580-8 (2 figs.).

§ Tijdschr. Nederland. Dierk. Ver., xi. (1909) pp. 153-286 (107 figs.).

|| Anat. Anzeig., xxxvii. (1910) pp. 4-5.

hairs. On the foot there is a hair-covered region on the sole, separated from the lower leg by a hairless stretch. But among the foot hairs there are no sinus hairs, so the tactile importance must be much less than in the case of the hand, as indeed one might expect.

Double Gall Bladder in Cat.*—R. Löwy records two cases of this very rare abnormality—the presence of an accessory gall-bladder close beside the normal gall-bladder. The two open together into one cystic duct.

Adaptation of Ptarmigan to High Altitudes.†—J. Strohl has made a careful comparison of the ptarmigan, *Lagopus alpinus* or *mutus*, with the willow grouse, *Lagopus lagopus* or *albus*, from the plains. The most noteworthy difference is in the compensatory hypertrophy of the right ventricle in the ptarmigan—a specific adaptation to the life at great altitudes. Even a young bird (from 3000 m.) showed the hypertrophy in the same degree as the adult.

Peculiar Organ in Finches.‡—A. Chappellier describes in the female sparrow and in some other Fringillidæ a convoluted duct extending on each side from the cloaca upwards beside the ureter. It seems to have been noticed by Belon in 1555. The question is whether it is a glandular annex or a persistent Wolffian duct.

Newt without Lungs.§—L. Lapieque and J. Petetin have studied the respiration of a Corsican newt, *Euproctus* (or *Triton*) *montanus*, which lives under stones in the dry beds of streams. It makes respiratory movements exactly like a newt with lungs; the walls of the bucco-pharyngeal cavity show marked vascularization. When the nostrils and mouth were kept shut the respiratory movements ceased, but the animals remained normal. Therefore the bucco-pharyngeal respiration is not essential. When two specimens were plunged in a bath of vaseline, and the head left free in the air, they died in 24 hours. Therefore the skin is the essential organ of respiration in these forms.

Oyster-eating Fishes.||—T. Southwell finds that the fishes most destructive to pearl-oysters (*Margaritifera vulgaris*) and oyster-spat are those included in the family Gymnodontes and commonly known as globe-fishes; that *Lethrinus miniatus*, one of the Pagrina, is also very destructive to spat, and is seldom or never found without oysters in its stomach; and that as yet no spat or oysters have ever been found in the stomach of any ray or shark, although there is every reason to believe that many of the larger species in these orders commit great ravages.

Urogenital Organs of Chimæra monstrosa.¶—T. H. Burlend gives an account of the structure of these organs and calls attention to the following facts as deserving of special notice. The urinary organ of

* Anat. Anzeig., xxxvii. (1910) pp. 8-9 (fig.).

† Comptes Rendus, cl. (1910) pp. 1257-60.

‡ C.R. Soc. Biol. Paris, lxi. (1910) pp. 59-61 (3 figs.).

§ Tom. cit., pp. 84-6.

|| Ceylon Marine Biol. Reports, ii. (1910) pp. 175-8 (10 figs.).

¶ Proc. Zool. Soc., 1910, pp. 510-34 (14 figs.).

the young male differentiates in the adult into anterior paired Leydig's glands and a posterior unpaired kidney. The glands of Leydig do not function as a renal organ, as is shown by their minute structure and by the contents of their ducts. From the condition of the spermatozoa at intervals in the long coiled sperm-ducts (Leydig's ducts) it may be inferred that the function of the glands of Leydig is the secreting of a fluid which nourishes the spermatozoa.

The sexual kidney or "Geschlechtsniere" is represented in the adult male only by the rete testis, efferent ducts and longitudinal collecting duct. Moreover, an epididymis, as usually defined, is absent. The development of the glands of Leydig is accompanied by changes in the sperm-ducts and the formation of highly complex sperm-vesicles. The anterior region of the urinary organs undergoes retrogressive development, as is shown by a comparison of this structure in immature and adult females.

There is a distinct urogenital sinus in the young female which does not persist in the adult. The application of the term "receptaculum seminis" to the digitiform gland found ventral to the urinary bladder is erroneous, and this structure must for the present be regarded as a female accessory genital gland of obscure function.

Skeleton of Frilled Shark.*—T. Goodey gives an account of the skull, arches, vertebral column, girdles, fins, and mixipterygia of *Chlamydoselachus anguineus*. The following are a few of the most important points dealt with in the paper:—

The membranous labyrinth is described and figured for the first time. It is of the usual Selachian type, resembling rather closely that of *Hexanchus griseus*.

In regard to the formation of the centra, there are at the anterior end of the vertebral column well-developed, calcified, cyclospandylic centra; there are slight constrictions of the notochord in the trunk region, best seen in horizontal longitudinal section, not calcified—the lowest stage in the development of centra; in the main caudal region, calcified cyclospandylic centra occur, of two sizes corresponding with the doubling in the number of arcualia, which here, more than elsewhere in the vertebral column, grow round the notochord and greatly strengthen the centra.

The terminal caudal region is heterospandylic, and not monospandylic, as in many other Selachians. The musculature and skeleton of the mixipterygia, or copulatory organs, are dealt with fully for the first time.

What is a Monstrosity?—O. Abelt† sums up the result of a long discussion on this subject. It ended in adopting a definition given by R. von Wettstein:—"A monstrosity is an occasional, non-pathological deviation from the normal structure of an organ, which essentially transcends the experimentally probable variability of the organ or the organism."

* Proc. Zool. Soc., 1910, pp. 540-71 (5 pls.).

† Verh. Zool. Bot. Ges. Wien, lx. (1910) pp. 129-40.

INVERTEBRATA.

Mollusca.

γ. Gastropoda.

Adaptive Structure of *Acera*.*—Rémy Perrier and H. Fischer describe some of the peculiarities of this genus. The coils of the spire do not fuse as usual, but remain free at the sutural margin, leaving a narrow cleft extending round the shell. This cleft is really open only near the mouth of the shell; in other parts it is covered by an envelope, at first membranous, afterwards calcareous, which secondarily unites the various coils. To the open portion of the cleft there corresponds a deep pallial sinus, with the single aperture of the pallial cavity. These and other peculiarities are shown to be adaptations to a limicolous life in troubled and muddy water.

Gill of *Bulleidæ*.†—Rémy Perrier and Henri Fischer describe the structure of the gill in *Haminea hydatis*. It is remarkable in having only a few sporadic ciliated cells, and even these have weak cilia. The same is true of the mantle generally, but there are two ciliated pallial bands strongly developed, and on their activity the movement of the water in the mantle-cavity depends almost exclusively.

Double Snail.‡—H. M. MacCnrdy describes a double specimen of a species of *Campeloma*. It had two separate dextral shells (10 mm. in diameter) slightly smaller than the average, two opercula, two pairs of eyes, and two pairs of tentacles. To what extent the internal organs were duplicated was not determined. The left side of the foot of each individual was closely united with the left side of the other in such a manner as to bring the forward movements of each individual in more or less direct opposition to the movements of the other. "Locomotion was thus impeded, though the dominating influence of one which was slightly larger than the other always determined the direction of movement." The interesting specimen or specimens lived only a few days.

Arthropoda.

a. Insecta.

Nesting Habits of *Bembex nubilipennis*.§—J. B. Parker describes the behaviour of this large solitary wasp, known in Kansas as the yellow jacket. Though solitary, they nest in colonies. A sloping burrow is made in the ground, and the eggs are laid in lateral chambers. In no case was more than one developing larva found in a burrow. The mouth of the burrow is closed when the wasp leaves or enters the nest. It seems that all burrows with immature larvæ are closed up at night-fall with the female inside. A small fly (Tachinid) makes persistent efforts to enter when a burrow is open. The food of the larva consists of house-flies, stable-flies, flesh-flies, and the like.

* Comptes Rendus, cli. (1910) pp. 248-50.

† Tom. cit., pp. 102-4.

‡ Rep. Michigan Acad. Sci., xi. (1909) p. 119.

§ Ohio Nat., x. (1910) pp. 163-5.

Argentine Galls.*—J. J. Kieffer and P. Jörgensen describe a large number of interesting new galls from Argentina, mostly from the province Mendoza. The galls are chiefly due to Cecidomyidæ and Tripetidæ among Diptera, and to Lepidoptera. Two are due to Cynipidæ, two to Chalcididæ, two to Psyllid Hemiptera. Numerous new hymenopterous parasites of the gall-makers are described—Chalcididæ, Platygasteridæ, and Braconidæ.

Sensory Structures on Worker Bee's Mandible.†—Charles Janet describes on the mandible of *Apis mellifera*, a variety of hair-like sensory structures ("macrochètes," "microchètes," and "cones"), and also more elaborate minute sensilli, protected by the setæ and opening on the cuticle by pores.

Myrmecophilous Caterpillars.‡—H. Viehmeyer discusses the myrmecophily of the caterpillars of *Catochrysops cnejus* Fabr. (from Manila), and gives a list of myrmecophilous Lycænidæ of the Indo-Australian region. Secreting pores in *Catochrysops* furnish the attraction for the ants (in this case *Polyrhachis dives* Smith); and there are also evaginating tubes, which appear after the second moult. The tubes bear bristles and may be tactile like the tufted hairs on the skin. Viehmeyer regards the appearance of caterpillars of Lycænidæ in ants' nests as more or less accidental.

In a subsequent paper§ on a myrmecophilous Lycænid chrysalis from the Philippines, Viehmeyer deals with a species of *Arhopala* found in a hanging nest of *Camponotus quadrisectus*. When the nest was broken, the furious ants grouped themselves around the chrysalids (which lay within special cells) as if to defend them. The pupa seems to act as a food-purveyor to the ants, giving them from a chitinous crater the secretion of two glands, a sort of honeydew.

H. Zerny|| gives an interesting account of those caterpillars, notably of Lycænids, which are found in association with ants. They are protected by their companions, and in turn provide them with a delectable secretion. The author discusses some typical instances, and gives a useful bibliography.

Palæarctic Tortricidæ.¶—J. Kennel continues his elaborate memoir on this family of moths, dealing with *Tortrix*, *Philedone*, *Epagoge*, *Cacacia*, *Anisotænia*, and related genera.

Horn-feeding Lepidopterous Larvæ.**—August Busck figures the long horns of a large water-antelope (*Cobus* sp.), which showed striking infestation with the curious larvæ-tubes of a microlepidopteron, *Tinea vastella* Zellar. There were large bunches of dark-brown finger-like tubes about $\frac{1}{4}$ in. in diameter, $\frac{1}{2}$ – $2\frac{1}{2}$ in. in length. These tubes are very tough, being made of silk, with which earth and chewed horn are

* Centralbl. Bakt. Parasitenk., xxvii. (1910) pp. 362–414 (61 figs.).

† Comptes Rendus, cli. (1910) pp. 618–21 (3 figs.).

‡ Philippine Journ. Sci., v. (1910) pp. 69–72.

§ Tom. cit., pp. 73–7 (4 figs.).

|| Verb. Zool. Bot. Ges. Wien, lx. (1910) pp. 93–103.

¶ Zoologica, xxi. (1910) heft. 54, pp. 101–232 (6 pls. and several figs.).

** Smithsonian Misc. Coll., lvi. (1910) No. 8, pp. 1–2 (2 pls.).

incorporated. The interior is smooth grey silk. The tubes are closed at their outer end, and are connected at their basal end with round holes leading into galleries in the horn. The skull was picked up on the ground in British East Africa by the Smithsonian African Expedition.

Procession and Pupation of Larvæ of *Cnethocampa pinivora*.*

T. G. Edwards describes a series of observations made at Arcachon, with a view to clearing up certain points in regard to the processional larvæ of *Cnethocampa pinivora*. The procession is always single file, the larvæ being arranged in head-to-tail contact. The length of the procession varies greatly, but only three were found which numbered over a hundred individuals. Experiments were made to determine how far the primite, or the first on the file, may be regarded as the true leader. It was found that any larva might function as primite, but that one individual usually retained the post, and was apparently capable of taking a certain initiative in the selection of a path, burrowing for pupation and forming a circulating mass. Light and surface seem to be the determining factors in the choice of a path. A whole procession was cast into shade, and a reflected ray of light was cast under the head of the primite. The whole procession followed the ray, though only the primite could have been influenced by the stimulus.

Before pupation, the procession breaks up into a mass in which the larvæ are continually moving about among each other without advancing from the same spot. This formation was observed at other times also; and when the procession reformed without pupation, the same larva took the lead and followed the outward-bound thread back to the nest. Artificial threads, or threads of other processions, placed in his path were always rejected. Artificial breaks in the thread did not prevent joining up if the distance between the two parts of the procession was not great. Head-to-tail contact seemed of more importance in keeping the procession together than the thread. Before pupation, the mass formed in a position apparently selected by the primite, which was observed to test the consistence of the sand with its mandibles. The whole mass rotated until a gradually deepening depression was formed in the sand. All the while the larvæ were depositing their silken threads until a regular network was formed, and in this the loosened sand became entangled. The larvæ seemed to aid in the process by displacing the sand with their mandibles, and in a few days the whole mass was buried to a depth of several inches. Pupation was completed nineteen days after burrowing. Larvæ which had become isolated buried themselves by means of their mandibles. The facts seem to the observer to warrant the conclusion that, though the individuals of a procession may act alike when influenced by the same stimuli, yet each larva is capable of independent action, and that therefore the procession cannot be said to act in any real sense as a single individual.

Effect of Centrifugal Force on the Development of Beetles.†

R. W. Hegner has made some interesting experiments on the eggs of Chrysomelid beetles, such as *Calligrapha multipunctata* and *Leptinotarsa*

* Proc. Cambridge Phil. Soc., xv. (1910) pp. 431-6.

† Rep. Michigan Acad. Sci., xi. (1909) pp. 123-5.

decemlineata, which he subjected to "centrifugal force." The older the egg the more chances there are of its normal development after centrifuging, and the general result of the experiments is to show that these highly-organized eggs may have their contents profoundly disturbed without preventing the production of a normal embryo. The cytoplasm and the nuclei of centrifuged eggs are forced out of their usual positions, but often normal development takes place. A high degree of organization does not prevent the egg from adapting itself to changed conditions.

Myiasis Narium.*—A. W. Blain reports a case of human myiasis in the nose, due to the maggots of the screw-worm fly (*Comptosomyia macellaria*). A fly entered the nose and laid its eggs. Twenty-five maggots were removed. It seems that this parasitism is by no means rare in man. Yount records twenty-three cases occurring in Arizona in one year (1905); eighteen showed nasal myiasis, and five in some other site. For the nasal cases alone the mortality was over 22 p.c., which is enough to demonstrate the serious nature of the disease. The screw-worm fly also attacks horses, sheep, and cattle.

New Cordylobia.†—E. E. Austen describes *Cordylobia prægrandis* sp. n. from Cape Colony, Natal, and Rhodesia, specially interesting because the other members of the genus are, in their larval stages, subcutaneous parasites in Mammals. The larvæ of *C. anthropophaga* Grünb., and *C. rodhaini* Gedøelst., regularly attack man.

Larvæ and Pupæ of West African Culicidæ.‡—W. Wesché has done a most useful piece of work in giving a precise, but not too technical, description of a large collection of mosquito larvæ and pupæ made at Lagos, by W. M. Graham. He deals with twenty-nine species, and gives valuable keys to both larvæ and pupæ. There is a clear introduction dealing with the characters of the important parts, and Graham adds a number of field-notes and an appendix on collecting. Fifty-three mosquitos have now been found at Lagos.

Subdivisions of Genus Phora.§—J. R. Malloch has tackled this genus which includes such a large number of species. He proposes to recognize eight sub-genera, five of which are defined for the first time.

Flies as Disseminators of Typhus.||—E. Bertarelli submits the results of experiments which go to show that house-flies share in the dissemination of typhus germs. He points out that cleanliness of rooms and floors is of more importance than anything else.

Hemiptera Injurious to Cocoa.¶—G. C. Dudgeon discusses a species of *Helopeltis* from the Gold Coast, the immature form of which punctures the pods of cocoa, and *Sahlbergella theobroma* Distant, which perforates the stems and does great damage.

* Rep. Michigan Acad. Sci., xi. (1909) pp. 114-15 (3 figs.).

† Bull. Entomol. Research, i. (1910) pp. 79-81.

‡ Tom. cit., pp. 7-54 (7 pls.).

§ Glasgow Nat., i. (1909) pp. 24-8.

|| Centralbl. Bakt. Parasitenk., liii. (1916) pp. 486-95.

¶ Bull. Entomol. Research, i. (1910) pp. 59-61 (1 pl.).

Injurious Insects.*—E. P. Felt reports on a variety of injurious insects of the State of New York. Experiments were made to test the behaviour of the house-fly or "typhoid fly" (*Musca domestica*), in relation to light. It was found that the fly does not breed freely in darkness, and it is advised that manure be kept in dark places. The voracious caterpillars of the brown tail moth (*Euproctis chrysorrhœa*), imported in New York State with French seedlings, the apple-worms of the codling moth (*Carpocapsa pomonella*), the hickory leaf stem borer (*Acrobasis feltella*), and many other injurious insects are dealt with.

γ. Myriopoda.

British Millipedes.†—T. J. Evans records some œcological observations on the habits of some British Millipedes. In general, they feed on decaying matter, animal and vegetable, though the Julids like fresh vegetables.

In *Glomeris limbata* (= *marginata*) the breeding period extends from March till the end of July. The male is much smaller than the female. Copulation takes place by a head-to-tail apposition. A preliminary loading of the male's copulatory appendages must take place. Egg-laying is an interrupted process. The eggs are usually buried in the loose soil near the surface, and always under cover of moss or dead leaves. In a neat way, carefully described, the egg is enclosed in an excrementitious shell.

In *Polydesmus complanatus* the breeding period is as in *Glomeris*, but copulation may occur in warm weather at any time. The copulation lasts two days or more. About three weeks intervene between fertilization and the nest-building. All the eggs are enclosed in a well-made dome-shaped tent, the making of which is carefully described.

In Julidæ the nest is a much cruder structure, and the building instinct of a much lower order. It is mainly made from the inside, the top only being laid on from outside.

During moulting the Julids and Polydesmids hide in a nest-like recess, but *Glomeris* seeks no special protection. In studying Millipedes it is important to accustom them first of all to moderate light.

δ. Arachnida.

New Genus of Solifugæ.‡—S. Hirst establishes a new genus *Barrella* from Biskra. It is closely allied to the Egyptian genus *Barrus* and to *Rhinippus* from Asia Minor. It differs from *Barrus* in having the anterior margin almost straight, and in having the spines of the head-plate placed on a slight eminence, their bases being situated close together. From *Rhinippus* it differs in the larger number of the spines on the ocular tubercle, in the presence of spines on the head-plate, and in the possession of a flagellum.

Ten-legged Pantopod.§—E. L. Bouvier calls attention to a new decapod Pycnogonid, *Pentapycnon charcoti* g. et sp. n., discovered by the Charcot Antarctic Expedition. It is far apart from *Decolopoda* and

* New York State Mus., Bull. 141 (1910) pp. 1-178 (22 pls.).

† Ann. Nat. Hist., vi. (1910) pp. 234-91.

‡ Tom. cit., pp. 367-8 (2 figs.).

§ Comptes Rendus, cli. (1910) pp. 26-32.

Pentanympyon (which were also found), and belongs to the family Pycnogonidæ. Unlike the 'Scotia' and the 'Discovery,' the 'Pourquoi-Pas?' obtained a true Pycnogonid, *Pycnogonum gaini* sp.n. Bouvier points out that the decapod types are primitive, that *Decolopoda* leads on to *Colossendeis*, *Pentanympyon* to *Nympyon*, and *Pentapycnon* to *Pycnogonum*. It is interesting to find all the three primitive types in the Antarctic Seas, and perhaps there is still to be found the decapod form of the Ascorhynchomorphs of Pocock.

Olenellus and other Mesonacidæ.*—Charles D. Walcott gives an account of the development of the body in Mesonacid Trilobites, and revises the classification. He adds several new genera—*Nevadia*, *Wanneria*, *Pædeumias*, and *Peachella*, and a number of species. He discusses the abrupt appearance of the Mesonacidæ, and the transition to Paradoxinæ.

e. Crustacea.

Dimorphism of Males in Saron.†—H. Coutière corroborates the conclusion of Borrodaile that *Saron* (or *Hippolyte*) *marmoratus* and *gibberosus* are dimorphic males of one species. The form *gibberosus* includes all the females and most of the males; the males of the *marmoratus* type are always very mature.

Australian Amphipods.‡—T. R. R. Stebbing reports on the 'Thetis' collection of Amphipods, which includes three new genera and thirteen new species. The new genus *Ochlesis* is worthy of note, since by the character of its maxillipedes it forms a link between the Gammaridea and the Hyperiidea. For this reason it appears to justify the institution of a new family, the Ochlesidæ. In all, forty-four species have been identified among the specimens of the 'Thetis' collection.

New Alpheidæ.§—J. G. De Man continues his report on the macrurous Decapod Crustacea collected by the Siboga Expedition. He describes 29 new species of Alpheidæ, making a total of 113 species (57 new). One new genus, *Aretopsis*, is established, in the immediate vicinity of *Arctæ*.

Rare Decapods.||—Mary J. Rathbun reports on a collection of Decapod Crustaceans collected in Dutch East India and elsewhere by Thomas Barbour. The collection includes the rare *Thaumastocheles zaleucus* from deep water off Japan, in which the large chela is 108 mm. in length, the whole body being 153.5 mm. Other species little known in collections are *Utica nausithœ* and *Macrophthalmus definitus*.

Commensalism of Sea-anemones and Hermit-crabs.¶—G. Brunelli has experimented with *Adamsia rondeletii* and *Pagurus arrosor*, the hermit-crab being deprived of its commensal and placed in an aquarium with fixed and free Actinians. In detaching and attaching an Actinian

* Smithsonian Misc. Coll., liii. No. 6 (1910) pp. 232-422 (22 pls.).

† Comptes Rendus, cl. (1910) pp. 1263-5.

‡ Mem. Australian Museum, Sydney, iv. pt. 2 (1910) pp. 567-658 (14 pls.).

§ Tijdschr. Nederland. Dierk. Ver., xi. (1910) pp. 287-319.

|| Bull. Mus. Comp. Zool., lii. (1910) pp. 307-17 (6 pls.).

¶ Atti Rend. R. Accad. Lincei Roma, 1910, pp. 77-82.

the Pagurid exhibits a series of actions which vary according to the physiological state of the Actinian. It stimulates the Actinian in quite definite ways. In contrast to such a case, the association of *Actinia equina* and *Paguristes oculatus* is accidental or indifferent.

Notes on Ceylonese Hermit-crabs.*—T. Southwell found *Cancellus investigatoris* Alcock, whose habitat has not been recorded, occupying a small cavity in a piece of *Porites arenosa*. When the animal was retracted the modified portions of the chelipeds and legs formed a remarkably perfect and inconspicuous operculum. Similarly, he found *Diogenes rectimanus* in cavities of living coral (*Goneastrea*). A new species, *Clibanarius willeyi*, is described and a list is given of the Anomuran Fauna of Ceylon.

Colour Change in Ligia.†—John Tait notes that specimens of *Ligia oceanica* exposed to light in a black-painted dish retain their dark appearance (due to numerous highly branched black or dark brown chromatophores in the epidermis), while those exposed in a white dish gradually grow lighter in colour and more transparent, so that eventually the heart can be seen beating through the integument. This effect is due to a retraction of the black chromatophores. (In the laterally situated lighter patches in the normal animal there are also white chromatophores.) When a *Ligia* is blinded by having its eyes painted over with lamp-black in Canada balsam it does not undergo the usual change of colour on transference to a white background. The stimulation of the chromatophores seems therefore to be wholly indirect, the eye being the receptor organ.

Blood-coagulation in Gammarus.‡—John Tait notes that the process of blood-coagulation varies with the species of *Gammarus*. In *G. marinus*, found near the upper tide-limit on the beach, cell-agglutination seems to be the only visible factor in the formation of a clot; in *G. locusta*, found lower in the ebb, "globule" formation, associated with explosion of thrombocytes, is the prominent feature.

Light and Pigment-formation in Crenilabrus and Hippolyte.§—F. W. Gamble publishes a further instalment of the results of his experimental study of the colour-physiology of the prawn *Hippolyte varians*, and the wrasse, *Crenilabrus melops*. The immediate object of the present series of experiments was to determine whether there was, in the young fish, a sensitive stage at all comparable to that possessed by *Hippolyte*. The investigator found that the colouring of the young specimens of *Crenilabrus melops* is due in part to the blue endoskeleton, in part to chromatophores. On backgrounds of seaweed they assume varied coloration. On brown weed they become brown, on green weed, green, and on red weed, green. In light transmitted through weeds, *Crenilabrus* assumes a colour, the complement of that which is most strongly represented in the incident light. Thus in light mainly green, a brownish red colour (due largely to red pigment) develops. In light mainly red, a green colour (due largely to yellow pigment) develops

* Ceylon Marine Biol. Rep., iv. (1910) pp. 179-84 (6 figs.).

† Proc. Physiol. Soc. (June 1910) 2 pp.

‡ Tom. cit., 1 p.

§ Quart. Journ. Micr. Sci., lv. (1910) pp. 541-94 (pl.).

In regard to *Hippolyte varians* the amount of larval pigment (which is always red) is constant in any brood, and it is correlated with the amount of red pigment present in the female parent in all colour varieties except green. A given green *Hippolyte* has one of three types of progeny—all red, all colourless—or a mixed brood, containing red and colourless individuals in a proportion of nearly three to one. The author considers that this suggests that green individuals are of two and possibly three kinds: (1) brown forms that have become green; (2) green forms that have undergone no change of colour; and (3) a cross between these two. But in the absence of the knowledge of the male parentage, the last suggestion required confirmation.

Light is not essential to the production of red pigment in the larva. Darkness does not prevent the continued production of red pigment in young forms. The action of monochromatic light upon the pigment-formation of *Hippolyte* is entirely different from that of a monochromatic background in white light. In pure red light yellow pigment develops. In some cases this leads to a green coloration, in others the colour remains yellow. In green light a carmine pigment is produced, and any red or yellow pigment existing in the experimental batch is either destroyed or disappears completely. On a red background in white light *Hippolyte* becomes reddish orange. On a green background in white light *Hippolyte* becomes green, but the colour is not retained if the batch is transferred to an absorbing dark background. Continued exposure to daylight and a white background produced hypertrophy of the red pigment along the nerve cord and a disappearance of the red and yellow pigment elsewhere. The production of the sympathetic colouring along the shallower zones of the coast is explained as a background effect, in which the incident diffused light plays little part. The influence of background is predominant. The production of crimson colouring in deeper water may be due to diffused green light. There is no evidence that the pigments of the food (Algæ) are the source of the pigments of *Hippolyte*.

East African Entomostraca.*—E. von Daday continues his account of the fresh-water micro-fauna in German East Africa, the present instalment dealing mainly with Cladocera and Ostracoda.

Alleged Mimicry in Acorn-shells.†—A. Joleaud deals with De Alessandri's view that certain details of ornamentation in the shell of *Balanus* are mimetic. Thus *B. mylensis* "takes on by analogy or by sympathy the form of the costules of *Isis melitensis*," on which it grows. But Joleaud shows that the foundation of the shell and the subsequent zones of increase always accommodate their shape to the undulations and irregularities of what they grow on, and there can be no question of mimicry.

Protandrous Hermaphroditism in Lernæopodidæ.‡—A. Quidor finds that in *Anchorella*, *Brachiella*, and *Lernæopoda*, the same animal may be first male and then female. In some cases (as in *Nicothoa*

* Zoologica, xxiii. (1910) heft 59, pp. 113-76 (4 pls.).

† C.R. Soc. Biol. Paris, lxi. (1910) pp. 101-2.

‡ Comptes Rendus, cl. (1910) pp. 1464-5.

astaci) abundant parasitic nutrition may bring on the female condition before the male function has been fulfilled.

Association of Barnacles with Snakes and Worms.*—A. Willey describes and figures a curious specimen of the sea-snake *Hydrus platurus*, which bore on the end of its tail a thick bunch of *Lepas anserifera* and *Conchoderma hunteri*. The specimen was brought alive to the Colombo Museum on July 23, 1909. The barnacles are simply epizoic, and so far as the snake is concerned an incubus which cannot be shaken off. Willey recalls Alcock's description of the Hydroid *Stylactis minoi* growing on a small rock-perch, *Minous inermis*, and he also notes that the barnacle *Lepas anserifera* is frequently accompanied by two Annelids, *Amphinome rostrata* and *Hipponoë gauvichaudi*, belonging to the family Amphinomidae. The second species is the rarer. It sometimes penetrates within the valves of the barnacle.

Annulata.

Marine Annelids of Dublin Bay.†—R. Southern gives a list of 115 species:—2 Archannelida, 94 Polychæta, 14 Oligochaeta, 1 Leech, and 4 Gephyrea. Of the following, 6 are new to the fauna of the British Isles:—*Protodrilus flavocapitatus* (Uljanin), *Grubea pusilla* (Dnjardin), *Autolytus megodon* de St. Joseph, *A. edwardsi* de St. Joseph, *Spio martinensis* Mesnil, *Prionospio steenstrupi* Malmgren. Altogether 37 species are added to the Irish fauna.

Precocious Maturity of Larval Spionid.‡—C. Viguier describes from the plankton of the Bay of Algiers some specimens of a larval Spionid, 1.6–1.8 mm. in length, which were remarkable in showing sexual maturity. Both males and females occurred. They are apparently the larvæ of a sedentary form, which have become pædogenic and pelagic.

Spawning of *Hydroïdes dianthus*.§—C. W. Hargitt records a very interesting case of spawning which he observed in a colony of *Hydroïdes dianthus*, newly transferred to an aquarium. About two hours after the transference a single individual suddenly discharged a jet of whitish matter, like milk. Almost immediately a second did the same, and in a few minutes dozens were actively engaged in discharging sperms and eggs, and the whole water was milky-white. The operation ceased suddenly at the end of 40 minutes, and the eggs, which were distinguishable from the first, settled rapidly downwards, but the spermatozoa floated for at least an hour. Males and females were about equal in numbers, and the phenomenon was apparently normal, though it had not been before observed in any of the colonies of the same species which had been kept for years in an aquarium. The author compares this case with the well-known spawning of the palolo worm, and suggests that both may be varying expressions of a spawning habit more or less common in Annelids, and not unknown in other Invertebrates.

* Spolia Zeylanica, vi. (1910) pp. 180–1 (pl.).

† Proc. R. Irish Acad., xxviii. (1910) pp. 215–46.

‡ Comptes Rendus, cli. (1910) pp. 104–6.

§ Amer. Nat., xliv. (1910) pp. 376–8.

Nematohelminthes.

New Species of Pseudalius.*—O. von Linstow describes *Pseudalius ovatus* sp. n. from the gullet and stomach of a dolphin (*Delphinus tursio*), and makes a note on the characters of the genus, which belongs to Schneider's Holomyaria, and, according to the longitudinal areas, to the Resorbentes. The eight other species have been found in the respiratory tract, heart and blood-vessels of marine Mammals, so that the new species is an exception in this respect.

Filaria in Turkey's Eye.†—M. Ozoux reports the frequent occurrence of Filariæ below the nictitating membrane in the turkeys of Reunion. As many as eight may occur in one eye. They soon die when removed into artificial media. There are none in the blood. The author refers the parasites to *Oxyspirura mansoni*, a species which occurs in the eye of the fowl.

Significance of Chitin in Nematode Development.‡—Jannes and Martin point out that the chitinous envelope of the egg is resistant to digestive juices and many chemical reagents, and that it assists survival in manifold conditions. In homoiothermal hosts, the parasitism is furthered by the physico-chemical properties of the chitin. If the temperature is low, the shell retains a relative impermeability; when the temperature rises, the permeability increases. "The chitin is a barrier, never quite shut, between the egg and the milieu. It opens more and more as the temperature rises, which corresponds, in natural conditions, to meeting the definitive host."

Hermaphroditism among Free-living Nematodes.§—F. A. Potts publishes an account of his study of the hermaphrodite species of free-living Nematodes, especially the two forms *Rhabditis gurneyi* and *Diplogaster linstovi*. His investigation confirms the work of Maupas, and adds some further details. In one hermaphrodite species, *Diplogaster maupasi*, the residual males are much more numerous than in any other yet studied, and in small cultures they may reach 30 p.c. of the whole number of individuals. The secondary male sexual characters, i.e. bursal papillæ and accessory copulatory spicule, show great variability. The production of males is cyclical; periods (each lasting a few generations) when males are frequent alternate with others in which only hermaphrodites are produced. Attempts to affect the sex-ratio artificially proved unsuccessful. It was also found impossible to increase the proportion of males by selection from favourable cultures. No rule could be discovered governing the constant fluctuations of production. Even when males were most common, there was no tendency to find females or partially hermaphrodite individuals, and the males were sexually inactive. The number of fertile eggs laid by *D. maupasi* is subject to wide variation. In *Rhabditis gurneyi* a far greater number of fertile eggs may be produced by a single individual than in any other herma-

* Centralbl. Bakt. Parasitenk., lv. (1910) pp. 133-5 (3 figs.).

† C.R. Soc. Biol. Paris, lxxviii. (1910) pp. 974-5.

‡ Comptes Rendus, cli. (1910) pp. 250-1.

§ Quart. Journ. Micr. Sci., lv. (1910) pp. 423-84 (11 figs.).

phrodite species. The fertility is probably as great as in the average bisexual species. The formation of spermatozoa is not confined to the anterior end of the gonad as in other species, but may occur in any part and at any time throughout maturity. Frequently a number of sterile eggs were laid at the beginning of maturity owing to the retarded production of the spermatozoa. No males have been observed in this species, so that they are either excessively rare or are extinct. Thus *R. gurneyi* represents a more complete type of hermaphroditism than has hitherto been recorded in the free-living Nematodes. Self-fertilization occurred as the exclusive means of propagation throughout forty-six generations of *Diplogaster maupasi* without any deterioration in the character of the stock.

Platyhelminthes.

Adult of Pearl-inducing Worm.*—T. Southwell submits a number of observations which go to show (though not as yet conclusively) that the pearl-inducing parasite in Ceylon oysters has only two hosts—namely, the oyster and most Elasmobranch fishes, and that the adult is *Tetrarhynchus unionifactor*, as previously determined by Herdman. It remains to prove this conclusively, and to discover how the infection of the oyster is brought about.

Endogenous Multiplication in Larvæ of *Tetrarhynchus unionifactor*. †—T. Southwell has observed the endogenous formation of larvæ within the cysts in the tissue of the oyster. In each case the "endogen" produced was single (a "monogen"), and was formed about the centre of the parent cyst. In one case the larva was liberated from the parent cyst by rupture of the wall while the cyst was lying free on the slide enveloped in the blood of the host. The asexual multiplication may explain why the infection of the more or less adult oyster is usually extensive, although the primary infection may be inconsiderable.

Regeneration in Nemerteans ‡—M. Oxner has studied the regenerative processes in *Lineus ruber* and *L. lacteus*. If a cut be made between cerebral organs and stomach-intestine, the head regenerates the whole posterior body. The intestine is regenerated from the rhynchocœlom, which is quite different developmentally.

If a transverse cut be made a little in front of the mouth, and a little in front of the end of the stomach-intestine, the mid-gut is perfectly regrown in 25 to 30 days, but even after 5 months there is no regeneration of the cerebral ganglia or cerebral organs or proboscis. If the mouth be also removed, it is not regrown, and the gut ends blindly in front.

If a cut be made immediately behind the cerebral organs, and another immediately in front of the beginning of the stomach-intestine, a fragment 2-3 mm. in length is obtained without any part of the central nervous system or digestive tube. It has some parts of the excretory tubes, and a piece of rhynchocœlom surrounded by parenchyma

* Ceylon Marine Biol. Rep., iv. (1910) pp. 169-72 (9 figs.).

† Tom. cit., pp. 173-4 (2 figs.).

‡ Comptes Rendus, cl. (1910) pp. 1618-20.

and muscle. This fragment regenerates the entire alimentary canal—mouth, stomach-intestine, mid-gut, and anus; it does not regenerate the cerebral ganglia or the cerebral organs or the proboscis.

It follows that the germinal origin of the parts regenerated is not very important; that the cerebral ganglia are not required in the regeneration even of very important organs; and that the regeneration occurs only on the aboral surfaces.

The author finds no satisfaction in the theory of regeneration set forth by Weismann, nor in Child's. He also points out that the phenomena called "typical regeneration," "morphallaxis," "dedifferentiation," and "diphagocytosis," pass into one another in these Nemerteans.

Egg of *Cerebratulus*.*—N. Yatsu has made an experimental study of the problems of germinal localization in the egg of *Cerebratulus lacteus*. He finds that germinal localization does not progress for at least five hours after release if the eggs are kept unfertilized. The germinal localization becomes more definite on the entrance of the spermatozoon. If a portion of one of the blastomeres is cut off during or after the completion of the first cleavage, no matter what plane the section may strike, the resulting deformity is very slight. If horizontal cuts in the animal region, or oblique sections in any region, be made on both the blastomeres during or after the completion of the first cleavage the effect is not great. If horizontal cuts be made along the equator or above it, anenteria often result. The extension of the endoderm basis is almost the same up to the 2-cell stage, that of the 4-cell stage has not been determined. All $\frac{1}{2}$, $\frac{2}{4}$ and $\frac{3}{8}$ -embryos are alike and almost normal, assuming the shape of young pilidia; $\frac{1}{4}$ -embryos are abnormal, the shifting of the apical organ to one side being found in some cases. In some of the $\frac{1}{4}$ -embryos the apical organ fails to develop. Bilaterality of egg-substances cannot be detected at the 4-cell stage. A $\frac{3}{4}$ -embryo may be perfect. At the 8-cell stage, if the horizontal cleavage is made so as to cut along the equator, the upper quartet always produces an anterior, while the lower one develops into a larva, thick-walled and devoid of the apical organ. If, however, the third cleavage plane is below the equator the result may be variable. The group of two animal cells and one vegetal cell of the 8-cell stage may develop into a perfect pilidium. If blastulas and young gastrulas be bisected horizontally, the pilidium from both the upper and lower halves may acquire the apical organ. If the apical organ be cut off after the late gastrula or young pilidium stage, it may be found regenerated in the late pilidium stage. If the cleavage pattern be modified by pressure or by lime-free sea-water (ring and plate-embryos) the resulting larvæ have always some abnormal features, yet in a general way they take the form of pilidia. In lime-free water differentiation and embryogeny are inhibited; nevertheless the blastomeres increase in number. When such cell-masses are put into ordinary sea-water they recover their differentiating power. On isolated cells produced by lime-free water a very few cilia may be scattered irregularly on the surface, while in the normal position these cells acquire cilia only in a restricted area. The author considers that these results suggest that there is a factor which in some way brings

* Journ. Coll. Sci. Univ. Tokyo, xxvii. (1910) pp. 1-36 (26 figs.).

back shifted blastomeres to the normal position, or at any rate to such a position that they are able subsequently to produce a larva deviating only slightly from the normal. The elucidation of this factor must be the object of further experiment.

Structure of Cephalothrix.*—G. Wijnhoff publishes the first of a series of papers on the genus *Cephalothrix*, and its significance for the classification of Nemerteans. The present paper deals with the anatomy of the genus. The general results are as follows. The single-layered skin-epithelium exhibits unicellular (hæmatoxylin) glands in the region of the foregut, but these show no tendency to form packets. The inner circular muscular layer of *C. filiformis* has preserved all the characters of an integumentary muscular sheath, for it surrounds all the organs, even the gonads. All the species investigated have a longitudinal muscular plate. Connective-tissue is only developed in the region between the brain and the mouth. In the nerve-tissue of the head there is a head-gland which suggests the glandular layer of *Callinera*. There is no difference between a head-gland and "submuscular glands." The proboscis has differentiated in the same way as that of *Callinera*, and indicates a remote relationship also with *Carinomella*, and possibly with some primitive Heteronemerteans.

In *C. filiformis* there is a circular musculature peculiar to the foregut. A true hind-gut is lacking in all Nemerteans. No true intestinal pouches are present. The two blood vessels anastomose only dorsally in the anterior portion of the head, and beneath the anus. The nephridia are not connected by a longitudinal canal, but each terminal bulb opens through an excretory duct to the exterior. The dorsal brain ganglia are very strongly developed; their fibre-nuclei are connected by lateral commissures with the ventral ganglia, but these are very slightly displaced towards the ventral commissure. The dorsal brain commissure lies in front of the ventral. The dorsal fibre-nuclei in species of *Cephalothrix* show no tendency to bifurcation. There is a subepithelial nerve-plexus in the foregut, and in this two nerves have been developed beside the œsophageal nerves. The anal commissure is ventral. The head-nerves are homologous with the nerve-layer in *Callinera* and *Carinesta*. Sharply defined sense-organs do not occur in the genus *Cephalothrix* in the strict sense.

Hermaphroditism of Prosorochmus elaparedi.†—G. Du Plessis has proved that *Prosorochmus elaparedi* Keferstein (= *Monopora vivipara* Salensky), is hermaphrodite. It is in many ways an interesting Nemertean, 50–60 mm. in length, brightly coloured, and viviparous, with the eggs hatching even in the interior of the ovaries. Small and well-hidden testes occur irregularly between the intestinal sacs, in animals which also show well-developed ovaries. There are two other hermaphrodite species in the Mediterranean, viz. *Tetrastemma marioni* and *T. kefersteini*, and the author suggests that *Prosorochmus* might well be included along with *Tetrastemma*. In the fresh-water *Stichostemma eilhardi* (Mont.), a small island of spermatozoa develops beside the large ovum within the ovary. In all the Geonemertea there is hermaphroditism.

* Zool. Jahrb., xxx. (1910) pp. 427–534 (4 pls.).

† Rev. Suisse Zool., xviii. (1910) pp. 491–5.

Echinoderma.

New Order of Asteroids.*—H. Ludwig unites, under the title *Notomyota*, a number of starfishes which have a peculiar musculature on the dorsal surface of the arms. On the internal surface of the dorsal integument there is a pair of longitudinal muscles, usually very strong, which proceed not from the disk, but from the proximal region of the back of the arms, beyond the disk. They extend to the tip, and along with the ventral muscles serve to move the arm up and down. Probably they make swimming movements possible. This should be looked for in the North Atlantic *Pontaster tenuispinus*, which lives at not very great depths. The new order includes two families: (1) *Cheirasteridae* (with no unpaired marginal plates), including *Pontaster*, *Pectinaster*, *Luidiaster*, *Cheiraster*, *Marchaster*, and *Gaussaster* g.n.; and (2) *Benthopectinidae* (with an unpaired upper and lower marginal plate), including *Pararchaster* and *Benthopecten*.

Incertæ Sedis.

Infection of Ophiuroid with Rhopalura.†—M. Caullery and A. Lavallée placed large numbers of the ciliated larvæ of *Rhopalura ophiocomæ* alongside of young specimens of *Amphiuira squamata* in the hope of discovering something in regard to the initial phases of infection. To obtain the larvæ it is only necessary to collect some Ophiuroids in a vessel, for some of them are likely to liberate male and female forms of *Rhopalura* through their genital clefts. The emissions almost always occur about five o'clock in the afternoon.

The larvæ enter by the genital clefts. In a manner which remains obscure, small plasmodia are formed, by the larvæ, especially in the vicinity of the gonads. These plasmodia are differentiated as male and female, and form germ-cells, morulæ, and embryos.

Cœlentera.

Reactions of Sea-anemones.‡—Georges Bohn has studied the behaviour of sea-anemones at low tide in the winter or early spring. When the tide goes out during the night, it often happens that the sea-anemones do not close up at all. It seems that the closure at low water is determined by an increase in the degree of illumination and not by any mechanical, physical, or chemical change in the water.

Madreporaria of the Gulf of Guinea.§—Ch. Gravier describes from San Thomé and Prince Islands six species of Madreporaria, whose geographical distribution is very interesting. Four species are more or less widespread in the West Indies, and occur also at the Bermudas, viz. *Mæandra cerebrum* (Ellis and Solander), *Favia fragum* Esper, *Orbicella annularis* Dana var., and *Siderastrea radians* (Pallas). One is found off the Cape Verde islands, viz. *Favia fragum* Esper. Another, *Oculina arbuscula* Agassiz, is known as yet only from one other locality, namely,

* SB. k. Preuss. Akad. Wiss., 1910, pp. 435-66.

† Comptes Rendus, cl. (1910) pp. 1781-3.

‡ C.R. Soc. Biol. Paris, lxxviii. (1910) pp. 964-6.

§ Ann. Inst. Océanogr., i. fasc. 2, pp. 1-28 (9 pls.).

from Florida. The sixth, *Porites bernardi* Gravier, is known only from Gabon and San Thomé. As the author points out, this record raises very interesting questions.

New Japanese Muriceids.*—K. Kinoshita describes *Filigella mitsukurii* sp. n., and in doing so revives Gray's genus *Filigella*, with which he merges *Elasmogorgia*. He also describes *Acis ijimai* sp. n. and *A. miyajimai* sp. n., and gives a fresh diagnosis of the genus.

Revision of Gorgonellidæ.†—J. J. Simpson has tackled an extremely difficult task in his revision of the Gorgonellidæ, and he is to be congratulated on having reduced the Juncellids to order. He recognizes only three valid genera—*Juncella*, *Nicella*, and *Scirpearia*—and gives emended diagnoses of these. His general scheme is as follows:—

Division 1. Spicules include clubs (*Juncella*).

Division 2. Spicules do not include clubs.

A. Spicules include long warty spindles and small double-clubs (*Nicella*).

B. Spicules include double-clubs and elongated double-clubs (*Scirpearia*).

The memoir deals with 4 species of *Juncella*, 16 of *Scirpearia*, and 4 of *Nicella*. The genera known as *Ellisella*, *Scirpearella* and *Ctenocella* are suppressed.

Japanese Medusæ.‡—Kamakichi Kishinouye describes a number of new forms, e.g. *Thaumatoscyphus distinctus* g. et sp. n., a Stenoscaphid with eight principal tentacles transformed into small and slender bodies, not adhesive; *Neopelagia eximia* g. et sp. n., a Pelagid with four per-radial and four interradial tentacles in the place of eight principal sensory clubs. A number of Hydromedusæ are also described, e.g. *Urashimea globosa* g. et sp. n., a Cladonemid with four radial canals, four amentiform tentacles, meridional bands of nematocysts on the ex-umbrella, and four interradial hollow spaces between ex-umbrella and sub-umbrella ("inter-umbrellar spaces"); *Scolionema gemmifera* g. et sp. n., an Olindiid with two kinds of tentacles.

Light Reactions of Gonionemus.§—Louis Murbach has experimented with this small jellyfish. He finds that change of light intensity, not light per se, is a normal stimulus for its reactions. The medusæ do not usually direct their movements to favourable situations, but continue to make random movements until they come into an optimum environment. Relative intensity of light, and not ray direction, determines the place of rest. Intense light may direct the medusæ, causing them to turn away from its source. Ordinary light seems to be important for the up-swimming activity, though it is not directive. The directive stimulus is due to gravity. Contact of the bell with air may cause the inhibition of movement and relaxation, allowing inversion of the bell by gravity.

* Journ. Coll. Sci. Tokyo, xxvii. (1909) No. 7, pp. 1-16 (2 pls.).

† Journ. R. Irish Acad., xxviii. sect. B, No. 7 (1910) pp. 247-386 (19 pls.).

‡ Journ. Coll. Sci. Imp. Univ. Tokyo, xxvii. (1910) pp. 1-35 (5 pls.).

§ Rep. Michigan Acad. Sci., xi. (1909) pp. 126-31 (5 figs.).

Tetraplatia.*—Albert Niedermayer discusses the position of this enigmatical Cœlenterate, which was first described by Busch in 1851. It is a small whitish animal, 1–5 mm. in length, covered with ciliated epithelium, and in shape like two four-sided pyramids united base to base. There seems to be much in favour of Carlgrén's view that the creature is a divergent Hydromedusoid, requiring a special family, Pteromedusæ, between Trachomedusæ and Narcomedusæ. Among the important features may be noted: the double wing-like lappets, the ex-umbrellar musculature, the motor-cells in place of sub-umbrellar musculature, the invagination of the gonads into the gastral cavity, the expansion of the manubrium, and the closing-off of the endodermal "auditory organ" by a velar vesicle. The single genus *Tetraplatia* is represented by two species, *T. chuni* Carlgrén, 1909, and *T. volitans* Busch, 1851.

Porifera.

Nature of Astrosclera.†—W. Weltner discusses the nature of the remarkable sponge which Lister described as *Astrosclera willeyana*, and regarded as a very divergent type of Calcarea. Weltner will not admit its position among the Calcarea, but regards it as an Ectyonine siliceous sponge. The calcareous sclerites which occur along with the siliceous sclerites belong to the basal part of a stone-coral on which *Astrosclera* is growing. This, at all events, is Weltner's re-interpretation of the facts.

Protozoa.

Nucleus of Amœbæ.‡—E. Chatton has made a study of the nucleus in various types of Amœba. In its simplest expression, Amœbæ of the *limax* type, the nucleus includes: (1) a caryosome formed of a fundamental substance (plastin), impregnated with chromatin, and containing a centriole; (2) a nuclear sap, more or less charged with a chromatin substance (identical with or very similar to that of the caryosome), and with an achromatin substance (linin); and (3) of a membrane, in most cases ill-defined. Such a nucleus is of the "protokaryon" type, and its division has been called by Nägler "promitosis." In more evolved types the elements and substances primitively condensed in the caryosome are separated out, and the division is a more complex "mesomitosis" or "metamitosis." The author recognizes three chief stages in the differentiation of the nuclear apparatus, and three forms of division (named above) corresponding to these.

Parasites of Labridæ.§—E. Chatton describes *Amœba mucicola* Chatton and *Trichodina labrorum* sp. n. from the gills of *Symphodus*, where they are associated with epidemic disease, the *Trichodina* probably preparing the way for the *Amœba*. The author gives a detailed account of the minute structure of *Amœba mucicola* and of its nuclear division. In an appendix he calls attention to an interesting point, that some

* Verh. Zool. Bot. Ges. Wien, lx. (1910) pp. 58–73 (3 figs.).

† Archiv Naturges., lxxvi. (1910) pp. 128–34.

‡ Arch. Zool. Expér., v. (1910) pp. 267–337 (13 figs.).

§ Tom. cit., pp. 239–66 (1 pl.).

individuals of *Trichodina* contained parasites which may be stages of *A. mucicola*. It may be that the Rhizopod is disseminated by the Ciliate.

Trypanosome in an Edentate.*—F. Mesnil and E. Brimont describe *Trypanosoma legeri* sp. n. from an ant-eater (*Tamandua tridactyla*). It is more like a Trypanosome of Birds than any species from Mammals. The ant-eater also harboured the young stages of a minute Nematode, which is recorded as *Microfilaria mathisi* sp. n.

Trypanosome of Lerot.†—A. Laveran and A. Pettit bring forward evidence pointing to the conclusion that *Trypanosoma blanchardi* found in *Myoxus nitela* is propagated by means of a flea, which Ch. Rothschild has named *Ceratophyllus laverani* sp. n.

Division of Trypanoplasma congeri.‡—C. H. Martin gives an account of his observations on *Trypanoplasma congeri*, a parasite of which the active form is found in the mucous lining of the conger's stomach. He finds that the division of this form shows hardly a single point of agreement with that of *T. helicis* previously described by Keysselitz, and doubts whether the two can be profitably united in a single genus. In the division of the active elongate stages of *T. congeri* the following features were noted. The basal granule divides. This is followed immediately by a splitting of the anterior flagellum, and later by the splitting of the posterior flagellum and membrane. The tropho-nucleus in the first stage enlarges, the intra-nuclear chromatin condensing on the karyosome. The tropho-nucleus assumes first a spindle and then a dumb-bell shape, which appears to persist to quite a late stage in the division. The karyosome appears to act as an internal division centre, and no trace of individual chromosomes can be seen at any stage of division. The kinetonucleus increases in size and divides by a simple transverse constriction. From its behaviour during division the kinetonucleus cannot be regarded as a centrosome, not at any rate so far as *T. congeri* is concerned.

New Parasites in Bulbul's Blood.§—C. Mathis and M. Léger have found in the blood of the bulbul, *Ixus hainanus*, three new parasites—two Protozoa, *Leucocytozoon brimonti* sp. n., and *Trypanosoma brimonti* sp. n., and a Nematode, *Microfilaria brimonti* sp. n.

Cytoplasmic Fibrillation of Chilomonas.||—J. Kunstler and Ch. Gineste find that there is a very complex internal scaffolding or framework of delicate fibrils in the cytoplasm of the common *Chilomonas paramacium*.

Revision of Genus Ceratocorys.¶—C. A. Kofoid points out that superficial resemblance to other Dinoflagellates in form and in organs of flotation on the part of the majority of the species of the genus *Cerato-*

* C.R. Soc. Biol. Paris, lxi. (1910) pp. 448-51.

† Op. cit., lxxviii. (1910) pp. 950-2.

‡ Quart. Journ. Micr. Sci., lv. (1910) pp. 485-96 (1 pl. and 1 fig.).

§ C.R. Soc. Biol. Paris, lxi. (1910) pp. 30-2. || Tom. cit., pp. 200-1.

¶ Univ. California Publications (Zool.) iv. (1910) pp. 177-87.

corys has hitherto hidden their true affinities. These are revealed by a study of their skeletal architecture, and in the light of this the author revises the species, adding a new one, *C. magna*.

Endogenous Multiplication of *Hæmogregarina sebai*.* — A. Laveran and A. Pettit point out that in this Gregarine—a parasite of *Python sebai*—there is notable variation in the endogenous multiplication according to the position of the cysts—in the lungs, liver, or other organs. Thus cysts with two or four merozoites are common, and others with thirty or more. But this does not indicate male and female elements nor two species, for the two sets are connected by “a disconcerting series of intermediate forms.”

Piroplasmidæ.†—C. França believes that there is need for the erection of a special family Piroplasmidæ. He gives the following definition: endoglobular Hæmatozoa, exhibiting at one of their phases an oval or pear-like form, never showing any pigment, multiplying by division, distributed by Ixodidæ. The family includes five genera—*Pyroplasma* Patton, *Theileria* Bettencourt, *Nicollia* Nuttall, *Nuttallia* g. n., and *Smithia* g. n.

Intestinal Stage of *Sarcosporidium*.‡ — L. Nègre fed mice with mouse-muscle infected with Sarcosporidia. The fæcal matter of these mice infected healthy mice. In the food-canal of a mouse, whose fæces were infective, there were found Protozoon cysts resembling the sporoblast stage of Sarcosporidia. The intestinal stage, proved experimentally, has not been actually demonstrated as such, but it is probable that this Protozoon cyst represents part of the life-history.

Miescher's Bodies.§ — J. Fiebiger discusses the nature of these bodies that occur in the muscles of herbivores, such as ox and sheep, pig and horse. The envelope with its appearance of rods is not an ectoplasmic envelope of the Miescher's body: it is modified muscular tissue. The sickle-like corpuscles arise by a peculiar transformation from the sporoblasts. There is subsequently a multiplication of the sickles by longitudinal division. The sickles break down both in the centre and in the periphery of the Miescher's body. The muscle-nuclei are stimulated to increase, movement, and change.

* Comptes Rendus, cli. (1910) pp. 182-5.

† Bull. Soc. Portugaise Sci. Nat., iii. (1910) pp. 11-13.

‡ C.R. Soc. Biol. Paris, lxxviii. (1910) pp. 997-8.

§ Verh. Zool. Bot. Ges. Wien, lx. (1910) pp. 73-88 (4 figs.).



BOTANY.

GENERAL,

Including the Anatomy and Physiology of Seed Plants.

Structure and Development.

Vegetative.¹

Phyletic Significance of Ray Tracheids in Coniferæ.*—W. P. Thompson has published an examination of the origin of the ray tracheids in Coniferæ, with a view to supplying a basis for determining their true phylogenetic significance. The author refers, in the latter connexion, to the work of Penhallow, who concludes that the number of ray tracheids in any species is in direct proportion to the degree of its specialization; and also to the contrary conclusion of Jeffrey, who maintains that the forms with few ray tracheids have been derived by reduction from forms with many.

The species investigated in detail were types of the hard and soft pines—*Pinus resinosa* and *P. Strobus*, the results being checked by comparison with several others; the regions specially examined were the primitive ones—seedling stem and root, young branch and young root of the adult, and seed-cone axis. In the young root, complete transitions were observed, from short tracheids between the rays to ray tracheids, both marginal and interspersed. The natural conclusion that the latter originate from tracheary tissue is supported by the fact that they develop in the cambial region of the seedling, and by the presence of tail-like projections on the ray tracheids, representing the smooth part of the tracheid as seen at the cambium. The occurrence of these ray tracheids bears a definite relation to that of albuminous cells; in *Abies*, the presence of the latter and the traumatic occurrence of ray tracheids indicates their vestigial nature. The regional and fossil distribution of the ray tracheids indicates their ancestral absence in the pines; hard pines are more specialized than soft ones. The large rays in *Pinus* are usually formed by the fusion of smaller ones. Ray tracheids are often replaced by parenchyma cells; the importance of this in the formation of secondary parenchymatous rays is pointed out.

The author concludes generally that ray tracheids are specialized structures, so that the greater their number the more recent in descent is the form in which they occur.

Reproductive.

Morphology and Relationships of the Podocarpineæ.†—Mary S. Young has contributed to our knowledge of the morphology of the

* Bot. Gaz., 1. (1910) pp. 101-16.

† Tom. cit., pp. 81-99 (3 pls.).

Podocarpineæ, which she has studied especially from the point of view of relationship. The affinities, the author concludes, are probably with the Araucarineæ, and both groups seem to be relatively primitive—but the question is by no means closed.

The paper deals firstly with the detailed structure of the gametophytes, fertilization-process, and the embryo of the critical genus *Phyllocladus*; and it is concluded that this genus (1) has primitive characters of the Taxineæ, which are being eliminated in the Podocarpineæ; (2) has primitive characters of the Podocarpineæ, which have been entirely eliminated in the Taxineæ; (3) has some advanced characters of Podocarpineæ; (4) the taxad resemblances are, on the whole, more superficial and variable—the podocarp features more fundamental; (5) the resemblances to Podocarpineæ lead forcibly to the conclusion that *Phyllocladus* is a relatively primitive member of Podocarpineæ which branched off from them shortly after their separation from Taxineæ.

The investigation proceeds with a survey of the gametophytes in Araucarineæ and Podocarpineæ, and the intermediate position of *Saxegothæa* is insisted upon, in agreement with Stiles, Norén, Thompson, and Tison.

The general conclusions lack definiteness, and it is clear that much further investigation is necessary before any decision can be arrived at in regard to relationships. The affinities of the Podocarpineæ with Araucarineæ are complicated with evidence of connexion, through *Phyllocladus*, with Taxineæ; and the two last named tribes appear to be widely separated in descent. At the same time, even without the evidence of *Saxegothæa*, the case for Araucarian affinities seems to be the stronger. On the other hand, the fact that the evidence for the Araucarian connexion is based largely on primitive characters is a weak point, for these may show merely that neither group has advanced far from the ancestral conifer stock. The remaining evidence rests chiefly upon the external morphology of the cones and the distribution of vascular bundles, and this is unsatisfactory because of the great variability of the structures concerned. We have much to learn concerning the Araucarineæ; the present conclusions are based largely upon the male gametophyte; the female is but little known, and the embryo practically not at all.

General.

Clusiaceæ of North-west Madagascar.*—H. Tunelle and H. Perrier de la Bathie publish a detailed account of the systematics of the Clusiaceæ found in North-west Madagascar, and nine new species are described. Many of the forms, it is pointed out, are so similar in appearance as to be named by the natives as one and the same—*Tsimatimanonta*. Most of them secrete a resinous substance resembling the gum-resin of *Tsimatima Pervillei*.

* Ann. Sci. Nat. Bot. ser. 9, xi. (1910) pp. 255-85.

CRYPTOGAMS.

Pteridophyta.

(By A. GEPP, M.A., F.L.S.)

Ancestry of Plants.*—A. Meyer publishes a hypothesis about the vegetative ancestry of the Pteridophytes, Gymnosperms, Angiosperms, and Bryophytes. He calls attention to the remarkable gaps which occur in the continuity of the vegetation which runs through the successive geological strata, the absence of any interesting remains in the Cambrian, and the lack of connecting links between the remains of the great groups of the Angiosperms, Gymnosperms, Lepidodendraceæ, Mosses, etc. It is astonishing that the Cambrian, which produced so many animals, should not have preserved adequate remains of its plants. The sudden appearance of the well-developed Lepidodendraceæ, Calamariaceæ, and the Cycadofilices in the Silurian and Devonian is very striking; so also the sudden appearance of the Angiosperms in the Cretaceous. Meyer does not believe in the theory that the connecting links have not been preserved. His hypothesis is that practically all our modern vegetation arose from a group of small plants, so tender and so fragile that though they lived up to Cretaceous times, yet very little if anything of them has been preserved. This group arose perhaps in Cambrian times from fresh-water algæ, and differentiated itself (as shown in a diagrammatic table) into sub-groups. In appearance it resembled the prothallia of ferns and the gametophytes of the mosses; it did not develop a sporophyte, but only a spore or sporangium, which gave rise directly to similar individuals. By gradual development and differentiation the various groups budded off from the primitive stock. The Cambrian flora was entirely marine, and then gradually came the formation of land and of fresh-water. He works out his hypothesis in detail.

Sex of Gametophyte of *Onoclea*.†—D. M. Mottier publishes some notes on the sex of the gametophyte of *Onoclea Struthiopteris*. The results of his very careful examination of innumerable plants are as follows. 1. The spores of *O. Struthiopteris* when grown upon earth, under optimum cultural conditions, produce regularly three kinds of prothallia: (a) small plants bearing only antheridia, the so-called male gametophytes; (b) larger prothallia bearing only archegonia, the female gametophytes; (c) those bearing both archegonia and antheridia, the bisexual or monœcious prothallia. 2. Archegonial prothallia, which continue growth without bearing a sporophyte, sometimes develop numerous small lobes from the older portions upon which numerous antheridia appear. 3. The gametophyte, therefore, is not strictly dioecious, and there is in all probability no sex-determining chromosome. 4. It is highly probable that the development of purely male or female gametophytes is not dependent upon conditions of nutrition, but that the sexual tendency is predetermined in the spore. Environmental conditions, or the failure of an egg to give rise to a sporophyte, owing to a lack of fecundation, may induce the development of antheridia upon

* Ber. Deutsch. Bot. Gesell., xxviii. (1910) pp. 303-19 (fig.).

† Bot. Gaz., l. (1910) pp. 209-13.

archegonial plants which continue their growth for some months. 5. Pure males result, in so far as is known, under good cultural conditions from the dominance of the male tendency in the spore over the female tendency.

Sporangium of *Lycopodium pithyoides*.*—A. G. Stokey gives an account of the sporangium of *Lycopodium pithyoides*, a rare species which presents some peculiarities. The stem apex is flattened; the sporangia are foliar in origin, but owing to displacement become cauline at maturity. They are very large and resemble those of *L. dichotomum*. The stalk is short. The leaf-trace bends out to the leaf without approaching the sporangium. The sporangium resembles that of *L. dichotomum* in the number of its wall-layers, four above, six to eight at base. Further details are added.

Tubers of *Polypodium Brunei*.†—G. Senn gives an account of the tubers of *Polypodium Brunei* collected by Werckle in Costa Rica. The tubers much resemble those of *P. bifrons* Hook. described by Ule in 1906. They are rounded hollow bodies with chambers; they spring from the rhizome and bear rootlets. Morphologically they are homologous with the tubers of *Nephrolepis tuberosa*. In their organization (opening, hollowness, chambering) they agree with the tubers of *Myrmecodia echinata*; and biologically they function exactly like the pitchers of *Dischidia Rafflesiana*, which, however, are transformed. Their original function is the storage of water, and their being inhabited by insects is secondary, and is not directly connected with the biology of the plant.

Apospory and Apogamy in *Trichomanes*.‡—P. Georgevitch gives an account of the apospory and apogamy of *Trichomanes Kaulfussii*, a subject already treated by F. O. Bower twenty years ago. Georgevitch confirms all that Bower described, but adds further details of the development of the gemmæ and a description of the antheridia formed upon the shoots that arise from the gemmæ.

***Lastrea remota*.**§—W. B. Boyd gives an account of a fern collected by him in 1894 on the side of Loch Lomond, where it grew in the immediate vicinity of *Lastrea Filix-mas* var. *puleacea* and *L. dilatata*. It has been pronounced by some experts to be identical with the *Lastrea remota* found by F. Clowes at Windermere in 1859, and described by T. Moore after a comparison with authentic specimens of *Aspidium remotum* Braun from Germany. Braun and Moore regarded the plants as hybrids. Upon this point copious extracts from various authors are given; and the conclusion arrived at by the author is that the Windermere plant is a hybrid between *L. Filix-mas* and *L. spinulosa*, while the Loch Lomond plant is a hybrid between *L. Filix-mas* and *L. dilatata*.

Scotch Ferns.||—J. J. Macdonald publishes a list of twenty-one species and three varieties of ferns found in the Comrie district.

* Böt. Gaz., l. (1910) pp. 218-20 (pl.).

† Verh. Naturf. Ges. Basel, xxi. (1910) pp. 115-25 (figs.).

‡ Jahrb. wiss. Bot., xlvi. (1910) pp. 155-70 (figs.).

§ Trans. Edinburgh Field Nat. and Micr. Soc., vi. (1909) pp. 85-92.

|| Op. cit., vi. (1908) p. 19.

Indian Ferns.*—J. Marten publishes a list of ferns found at and around Mussoorie, 1908. Fifty-nine species are enumerated, and notes as to locality, habitat, altitude, period of growth, economic uses, etc., are added.

Bryophyta.

(BY A. GEPP.)

Phylogenetic Classification of Mosses.†—L. Loeske publishes some studies of the comparative morphology and phylogenetic classification of the Mosses. His object is to found the classification upon the lines of Max Fleischer, namely, on morphology as well as on anatomy and fructification. He treats of the development of the peristome and the areolation in their relation to classification. He discusses the thirty-eight families in separate sections. In speaking of the Sphagnaceæ he calls attention to the xerophytic structure of the leaves, and connects the spiral fibre in the cell, not with any mechanical requirements, but with the rotatory direction of the water-current. The book abounds with novel ideas.

Phylogeny of the Archegonium.‡—L. Kurssanow discusses the phylogeny of the archegonium. He gives a résumé of the papers published by Davis and by Holferty in 1903 and 1904 respectively, and then describes some deviations from the normal structure of the archegonia in *Marchantia paleacea* which he has observed—for instance, three equal cells in the ventral cavity of the archegonium, also a multiplication of ventral canal cells. The latter has been explained as hermaphroditism, but this explanation is quite inadequate.

Abnormal Capsules in *Bryum argenteum*.§—W. Mönkemeyer describes and figures some peculiar abnormal forms of capsule in *Bryum argenteum*. Some are due to damage by insects. He adds that in case of *Brachythecium albicans rugulosum*, *B. salebrosum rugulosum*, *B. rivulare* f. *rugulosa*, *Pylæsia polyantha* var. *crispata*, etc., the characteristic plicate condition is probably caused by fungi, and is not inherited. They are merely pathological, and no more deserve a varietal name than do other mosses which are distorted by the action of the *Anguillulæ* which infest them. He urges students to experiment with certain named genera of mosses, and to endeavour to obtain artificially abnormal capsules such as he figures for *Bryum argenteum*.

Mechanism of Leaf-movements in Polytrichaceæ.||—W. Lorch discusses the minute structure and the mechanics of the absorbent tissue of the leaves of Polytrichaceæ. He gives a résumé of the work that has been done by Firsch and Stoltz respectively, and then describes various experiments carried out by himself, and treats of the minute anatomy of those parts of the leaf which swell up in water and cause the leaf-movements.

* Journ. Bombay Nat. Hist. Soc., xix. (1909) pp. 179–83.

† Studien zur vergleichenden Morphologie und Phylogenetischen Systematik der Laubmoose. Berlin: Lande (1910) 224 pp. See also Hedwigia, l. (1910) Beibl. p. (63).

‡ Bull. Soc. Imp. des Naturalistes Moscou, n.s. xxiii. (1909) pp. 39–43 (figs.).

§ Hedwigia, l. (1910) pp. 47–50 (figs.). || Flora, ci. (1910) pp. 373–94 (figs.).

Dicranoloma.*—J. Cardot discusses the propriety of the generic name *Dicranoloma* Ren., which had been called in question by I. Hagen in a pamphlet on nomenclature published at the International Congress of Botanists at Brussels. Hagen suggests two alternative meanings for the word. Cardot repudiates these suggestions, and says that the meaning which Renault intended the word to have is, *Dicranum* with bordered leaves.

Prehistoric Mosses from Lincolnshire.†—T. Sheppard gives a list of the mosses and hepatics found in the material used for caulking the prehistoric boat dug up at Brigg in 1886, and now preserved in Hull Museum. The species were determined by M. B. Slater, and comprise twelve mosses and eleven hepaticæ. The boat was excavated from a single oak tree, and is 47 ft. 6 in. long and 4 ft. 6 in. wide.

Yorkshire Mosses.‡—W. Ingham gives an account of the bryophytes collected by the Yorkshire Naturalists' Union near Middleton-in-Teesdale; more particularly at Hudeshope's Beck; between High Force and Cauldron Snout; Widdy Bank Fell; along Lunedale to Grassholme; Shacklesborough Moss. The latter is an extensive *Sphagnum* bog. Several interesting species of mosses and hepatics were gathered, and some notes on their habitats are given.

The same writer § also publishes a note on the rare moss *Plagiothecium sillesiacum*, collected in fruit at Fimber in the East Riding of Yorkshire. It had previously been gathered in Kent (1843) and in Yorkshire (1847). It was growing on rotting wood and pine needles.

Pallavicinia Flotowiana in Scotland.||—J. McAndrew records the finding of the rare thalloid hepatic *Pallavicinia Flotowiana* Lindb. on Gullane Links. Other stations for it in Scotland are the Sands of Barrie and Tents Muir; in England, Coatham marshes and Southport sands. It grows on damp spots among seaside sand-dunes, on ground apt to be covered with water in winter.

Distribution of Hepaticæ in Scotland.¶—S. M. Macvicar publishes a detailed account of the distribution of hepaticæ in Scotland, the outcome of several years' investigation. He gives in his first chapter a list of collectors, with their dates and with the species which they added to the Scottish flora. In succeeding chapters he touches on the ecology of hepaticæ, and discusses the influence of rainfall and latitude, the nature and requirements of the Atlantic species, the western as opposed to the eastern species, species in relation to habit and altitude, and makes a comparison with the flora of other countries, and a sketch of the flora of the following provinces: east and west Lowlands, east and west Highlands, Hebrides, north Highlands, Orkney and Shetland. The rest of the work is arranged systematically. Under each species the distribution is clearly displayed, the sub-province, vice-county, place and collector being recorded, with a generalized statement added, and notes on habitat, plant-associations, and so forth.

* Rev. Bryolog., xxxvii. (1910) pp. 105-6. † Naturalist, No. 643 (1910) p. 315.

‡ Op. cit., No. 642 (1910) pp. 265-7. § Tom. cit., p. 314.

¶ Trans. Edinburgh Field Nat. and Micr. Soc., vi. (1908) p. 67.

¶ Trans. Proc. Bot. Soc. Edinburgh, xxv. (1910) pp. 1-336.

Bryophytes of Co. Donegal.*—H. W. Lett gives an account of the mosses collected at Rosapenna and on Tory Island on the northern coast of Co. Donegal during the Conference week of the Field Clubs of Ireland. At Rosapenna were gathered 26 mosses and 8 hepatics never previously recorded for West Donegal. As to Tory Island, a wind-swept spot, a list of all the species is given, namely, 51 mosses and 24 hepaticæ.

European Hepaticæ.†—K. Müller publishes the twelfth part of his monograph of the European hepaticæ in Rabenhorst's *Kryptogamen-flora*. He completes the genus *Lophozia*, which contains thirty-five species and is divided into three sub-genera: *Barbilophozia*, with 11 species; *Dilophozia* (new), with 17; *Leiocolea* (new), with 7. He treats of five other genera of the tribe Epigomiantheæ, namely: *Gymnocolea* Dumort (2 species); *Dichiton* Mont. (1); *Anastrepta* Lindb. (1); *Acrobolbus* Nees (1); *Plagiochila* (2, unfinished).

Bryophytes of Dunkerque.‡—Bouly de Lesdain gives an account of the bryophytes of Dunkerque, which amount to 134 mosses, with 47 varieties and forms and 20 hepatics with two varieties. It is the flora of the sand-dunes which is specially interesting.

Moss-flora of the Haute-Saône.§—A. Coppey continues his phyto-geographic studies of the mosses of the Haute-Saône. He first discusses rock-formations and their relationship to different types of the mosses. Inter alia, he finds that the very same kind of rock, which in its dry undecomposed part bears a strictly silicicolous vegetation, produces a no less strictly calcicolous (by repute) flora, where its decomposition is rapid under the influence of a sufficient humidity. He then begins the floristic part of his work, and provides a systematic catalogue of all the Muscineæ of the Haute-Saône.

Prussian Mosses.||—L. Dietzow gives an additional account of the bryophytes of Grünhagen in West Prussia, bringing the total of species up to 274. The critical specimens were submitted to C. Warnstorff for determination.

Swiss Mosses.¶—P. Culmann publishes a contribution to the moss-flora of Switzerland, in which he describes two new varieties, and records new stations for a number of species—one from Grisons, three from the Jura, and twenty-three hepatics and thirty-seven mosses from the Bernese Oberland. Critical notes are appended to some of the species. *Moerkia Flotowiana* was gathered at so great an altitude as 6000 ft., near Zweisimmen; and yet it is perfectly distinct from *M. Blythii*, which grows on the Grimsel and descends to 5000 ft. Nor does Culmann believe that there are any intermediates which connect the two species.

* Irish Naturalist, xix. (1910) pp. 192-4.

† Leipzig: Kummer, (1910) vi. lief. 12, pp. 705-68 (figs. 322-40).

‡ Mém. Soc. Sci. Nat. Cherbourg, 1910, pp. 277-320.

§ Rev. Bryolog., xxxvii. (1910) pp. 99-105.

|| 32. Ber. Westpreuss. Bot. Zool. Verein. Danzig, 1910, pp. 91-8.

¶ Rev. Bryolog., xxxvii. (1910) pp. 93-9.

Geneva Mosses.*—A. Guinet gives an account of a moss-hunt on the Plaine de Rocailles, near Geneva, in March 1910. He indicates the species found respectively at the base and on the north side of the erratic calcareous blocks so characteristic of the landscape, on the south side of these blocks, on the surface of small "garides," amongst junipers, on the ground, shaded or open, on stumps, etc. The presence of some mountain species at an unusually low altitude is of interest. Special notes on the habit of *Rhodobryum roseum*, *Frullania Tamarisei*, and *Bryum argenteum* var. *lanatum*, are added.

Mosses of the Italian Islands.†—A. Bottini gives an account of the moss-floras of the various Italian islands, namely, the southern islands, Lampedusa, Linosa, and the Maltese group—Malta, Comino, Gozo. Sicily and the Lipari group. The Neapolitan group—Capri, Ischia, Procida, Nisida. Sardinia. The Tuscan Archipelago. The Tremiti group in the Adriatic. The principal results are a total number of 151 species recorded for Sicily; 74 for Malta; 68 for Sardinia; 54 for Pantelleria. The most interesting species are *Calymperes Somnieri* and *Thamnum cossyrense*—novelties from Pantelleria, the former being a moss of tropical affinities, and growing only beside a volcanic steam outlet; also *Barbella strongylensis*, a new member of a genus previously known only from India and Ceylon.

Polytrichaceæ of Western North America.‡—T. C. Frye publishes an account of the Polytrichaceæ of Western North America. He gives a description of the family, followed by a synopsis of all its genera, and a key to the seven genera found in North America. Similarly he supplies a description of each of these genera and a key to its species. In fine, he describes and figures each of the thirty-seven species occurring in the area in question.

Philippine Mosses.§—V. F. Brotherus publishes a third contribution to the bryology of the Philippine Islands, comprising 144 mosses. Among them are twenty-nine new species and a new genus, *Pseudoravelopus*, a remarkable member of the Polytrichaceæ, occupying a position between *Racelopus* and *Pogonatum*, and differing from the latter by having its leaves destitute of all papillæ and its seta papillose; and from *Racelopus* by the structure of the leaves.

Mosses of Western India.—H. N. Dixon|| gives a description of *Brachymerium torgidum*, a new species collected by L. J. Sedgwick in the Western Ghats of South India. The internal lamellæ of its peristome teeth are very strikingly developed. It is allied to *B. nepalense*, *B. lanceolatum*, and *B. glaucum*.

L. J. Sedgwick¶ gives an annotated list of thirty-five mosses from Western India, collected in Mahableshwar, Thana, Kanara, and other

* Bull. Soc. Bot. Genève, ii. (1910) pp. 95-6.

† Webbia ed. da U. Martelli, Firenze, ii. (1907) pp. 345-402.

‡ Proc. Washington Acad. Sci., xii. (1910) pp. 271-328 (figs.). See also Rev. Bryolog., xxxvii. (1910) p. 115.

§ Philippine Journ. Sci., Manila, v. (1910) pp. 137-62.

|| Journ. Bombay Nat. Hist. Soc., xix. (1909) pp. 536-7. See also Rev. Bryolog., 1908, pp. 94-6.

¶ Op. cit., (1910) pp. 938-42.

districts, by himself, Col. Kirtikar, R. M. Maxwell, and others, and determined by H. N. Dixon. Two new species are included, but not described.

Mosses of Madagascar.*—F. Renauld has published an illustrated quarto volume which contains an essay on the genus *Leucoloma* and a Supplement to the Prodrômus of the bryological flora of Madagascar and the Mascarene and Comoro Islands. In the first part, which occupies fifty pages, the anatomy of stem and leaf in *Leucoloma* is considered, and upon the characters afforded by leaf-tissue and nerve-structure the genus is split into three genera, *Dicranoloma*, *Leucoloma*, *Dicnemoloma*, and the two former are divided into sub-genera and sections. The second part (139 pp.) of the work is a supplement to the Prodrômus which appeared in 1898, and includes a description of the 163 plates which were published without text in the Atlas of Mosses of Madagascar.

Antarctic Mosses.†—J. Cardot gives an account of the mosses brought back by Shackleton's 'Nimrod' expedition from Victoria Land in the Antarctic region. The number of species is four, and three of these had already been found by Scott's 'Discovery' expedition in the same region, *Sarconeurum glaciale*, *Bryum argenteum*, and *B. antarcticum*; but the fourth constitutes a new record. It is a dwarfed form of *Dicranella Hookeri* = *Angstromia Hookeri* C. Müll. = *Anisothecium Jamesoni* Mitt. (in part), which was previously known from the Magellan region, South Georgia, Kerguelen and Heard Island.

Otto Sendtner.‡—H. Ross gives an account of Otto Sendtner (born 1813, died 1859) of Munich. He published lists of Silesian mosses in 1840 and 1841, studied the mosses of Carniola, Carinthia, the Julian Alps and Tyrol, and published a moss-flora of Upper Bavaria in 1846 and 1849. In 1847 he collected with great zeal in Bosnia, Dalmatia and the coast-lands of Austria, and distributed numbered sets of the plants, and published papers on this subject and on various other botanical matters. He also became Professor of Botany at Munich, where his plants are preserved. A bibliography is appended, and a silhouette portrait.

P. J. F. Gravet.§—T. Husnot gives a short obituary notice of P. J. F. Gravet (born 1827, died 1907), a Belgian bryologist, author of a list of the pleurocarpous mosses of Belgium (1875) and of various notes in the *Revue Bryologique*, and (with Delogne) of published sets of mosses, hepatics, and Sphagnaceae.

F. Renauld.||—I. Thériot publishes an obituary notice of Ferdinand Renauld (born 1837, died 1910), for thirty years an officer in the French Army, and subsequently for five years Commandant of the palace at Monaco. He published his first botanical paper in 1873, and his fifty-seventh in 1909. Beginning with the moss-floras of the

* Monaco (1909) 189 pp. (24 pls.). See also *Rev. Bryolog.*, xxxvii. (1910) p. 89.

† Shackleton, *Brit. Antarct. Exped.*, I. iv. (1910) pp. 77-9.

‡ *Ber. Bayer. Bot. Gesell.* xii. (1910) pp. 73-89 (1 pl.).

§ *Rev. Bryolog.*, xxxvii. (1910) pp. 91-2.

|| *Tom. cit.*, pp. 106-14.

Haute-Saône and of the Pyrenees, he passed on to a wide study (mostly in conjunction with J. Cardot) of the mosses of North America and tropical Africa, specializing more particularly in the moss-flora of Madagascar, his knowledge of which was unapproached. His principal works are the *Prodrome de la Flore bryologique de Madagascar* (1897), his *Essai sur les Lencoloma* (1909), the 163 plates of Madagascar mosses in Grandidier's *Histoire physique, naturelle et politique de Madagascar* (1898-1905). In conjunction with Cardot, he described seven genera and more than four hundred species. A list of his publications is included.

Thallophyta.

Algæ.

(By MRS. E. S. GEPP.)

Sexual Reproduction in Algæ.*—B. M. Davis discusses the nuclear phenomena of sexual reproduction in algæ, outlining the advances that have been made in cytological research on this subject, and including in his remarks a consideration of the sporophytic generation. As regards the problems of the origin of the sporophyte and the relations of the sexual and asexual generations to one another (whether or not they are essentially homologous or antithetic in the alternation of generations), the author does not deal directly with them. But his sympathies are strongly with the hypothesis of antithetic alternation of generations.

Sheath and Mucilage of Fresh-water Algæ.†—J. Virieux writes on his experiments with regard to the mucilage of fresh-water algæ, and gives the following conclusions. In the great majority of cases the mucilages are of a pectic composition, and are coloured more or less deeply by ruthenium, as well as by other characteristic reagents (old alum-hæmatoxylin, etc.). This holds good for Chlorophyceæ in general, Desmidiæ, Zygnemaceæ, Diatoms, *Batrachospermum*, *Chroococcus turgidus*, and certain species of *Phormidium*. The author, however, has found in two species a sort of mucilage, which stains strongly with anilin-blue, and is rapidly dissolved by a solution of potassium, applied cold. These characters point to the presence of callose. Such callosic mucilage, rare among plants in general, has hitherto been unknown among algæ.

As regards the Cyanophyceæ, the author has verified the statements of Lemaire regarding the presence of schizophycose in the sheath. It may be associated with several substances, cellulose (in *Tolypothrix penicillata*, and certain *Scytonema*), and pectin (in *Nostoc*, *Glaucapsa*, *Scytonema*, *Tolypothrix*). Sometimes there is added a brown colouring matter (scytonemin, glæocapsin), which occurs frequently in aerial forms. Again, certain sheaths, such as those of some *Schizothrix*, are composed of true cellulose. The author considers that of all the functions attributed to the sheath or to mucilage only that of serving as a water reserve is general. All the other functions are either very problematical or they apply to a very limited number of types. Protection against

* Amer. Nat., xliv (1910) pp. 513-32.

† Comptes Rendus, cli. (1910) pp. 334-5.

dissolved salts is a function of very negligible importance, since the author has convinced himself by numerous experiments that the presence of a more or less thick stratum of mucilage does not at all, or at any rate very little, delay osmotic movements across the membranes of algæ.

Vegetation of the Upper Rhine.*—R. Lauterborn writes an interesting account of the vegetation of the Upper Rhine. On account of the swiftness of the current the algæ can only live in the back waters, where a rich micro-flora is developed. The Lake of Zürich is a very important plankton-reservoir for the Rhine, and the Lake of Constance is not to be undervalued. The traces of this latter lake are seen in the Cyclotellæ, which are the most richly developed of all pelagic organisms in this lake. From these two basins of the Sub-Alps is poured a continuous stream of plankton into the Rhine of such species as can withstand the destructive influences around, such as Diatoms and *Ceratium*. Between Basel and Mainz the flora is greatly enriched by species which are not present in the lakes, and are supplied by the numerous old river beds, inlets and harbours of the Rhine. The author gives a description of the entire vegetation of the old river beds. He then treats of the biological character of the river, which is not in the least that of a valley, but far more that of a mountain water. He gives the names of the species which bear out this statement. In the final chapter the author deals with a good many individual species from the Lake of Constance and from the upper waters of the river itself.

Fresh-water Algæ of Dutch New Guinea.†—C. Bernard gives an account of the fresh-water algæ collected by Versteeg in New Guinea during the first Dutch expedition under H. A. Lorentz. The material was gathered at three stations, but is very limited in amount. The Desmidiæ are few, and Protococcaceæ are absent. He discusses the reasons for this. He enumerates twenty-three species and varieties, two of each being new. A bibliography is included.

Formation of Colonies in Flagellatæ.‡—A. Pascher describes certain cases of ephemeral colony-formation in Flagellatæ. Of the phylogenetic development of the colonies but little is still known, and the stages of association described by the author may be regarded as the precursors of the true colonies. The first observations of primitive colonies were made on species of Chrysomonadeæ. One species of *Chlamydomonas* was found in a palmelloid condition. The various stages of development in the different species are described in detail. At first the cells resulting from the first division remain loosely together, dividing later. Then follows the second division, making a colony of four individuals. Since the movement of the cilia remained unanimous, so long as the individuals were enclosed in a common sheath, locomotion formed no hindrance to the duration of such colonies. After the second division the cells may either separate as in *Ochromonas sociata*, or they may divide

* Ver. Natur. Medizin. Vereins Heidelberg, n.f. x. (1910) pp. 450-502 (2 figs.) See also Hedwigia, 1. (1910) Beibl., pp. (53) (54).

† Lorentz, Nova Guinea. Résult. Expéd. Sci. Néerlandaise. Leide: Brill (1910) viii. 2, pp. 253-70 (2 pls.).

‡ Ber. Deutsch. Bot. Gesell., xxviii. (1910) pp. 339-50 (1 pl.).

again and remain together, forming a colony of eight cells enclosed in a gelatinous envelope, as in *Chromulina Hokeana*. Already in such primitive cases of colony-formation the form of the future colonies is indicated. Such types are represented by *Gonium*, *Eudorina*, *Pandorina*, *Stephanosphæra*, etc. The individuals become fixed, the gelatinous envelope takes on certain characteristics and structure, and becomes less labile. The genesis of colony-formation in the Flagellates is shown in tabulated form, founded on the stages observed. Finally, descriptions of the new species of Chrysomonads are given in German.

New Parasitic Alga.*—Th. Mortensen and L. K. Rosenvinge describe a species of alga which is parasitic on the animal *Ophioglypha texturata* Lank., observed by the former author in the Limfjord. A description is first given by Th. Mortensen of the relation between the parasite and the host, and this is followed by Rosenvinge's description of the alga itself. The particular interest of this species lies in the fact that it is the first example known of an alga which is truly parasitic on an animal. Instances are known of algæ living in symbiosis with animals, but no instance has been known hitherto of an alga which caused such illness on an animal that death was the result. The alga, *Coccomyxa Ophiuræ*, is described and figured.

Phylogeny and Inter-relationship of the Green Algæ.†—F. E. Fritsch discusses the phylogeny and inter-relationships of the green algæ, indicating briefly the diverse lines of evolution that can at present be traced among the green algæ, and considering their connexion with the Flagellatæ. He also describes the salient features in the structure and life-history of the forms. He gives a digest of the works of other authors and appends a bibliography of seventy-one items. The relationship of the different groups is shown diagrammatically in a table.

Stauroneis Terryi.‡—T. C. Palmer describes and figures an anomalous diatom collected in Connecticut and published at first as *Stauroneis acuta* W. Smith, var. *Terryana* Tempère, the description being very short and inadequate. Later it was fully described by D. B. Ward as *S. Terryi*. The peculiarities of this species are that (1) it is the largest by far of the genus *Stauroneis*; (2) it is the only one of the genus to show sub-terminal depressions on the valves; (3) it is the only naviculoid diatom known that has a siliceous belt about its middle part. The author proves that *S. Terryi* cannot be a sport or monstrosity; but its relationship is so close to *S. acuta* that it may possibly represent a sporangial condition of that species. That view would explain the comparative rarity of the diatom in Terry's gatherings. But on the other hand one would expect them to find among all the material some indication of the process of return to normal form. Nothing of the sort has yet been seen, however. More and living material is necessary to solve the problems connected with the species.

* Overs. k. Dansk. Vidensk. Selsk. Forh., 1910, pp. 339-49.

† Science Progress, No. 16 (1910) pp. 623-48; No. 17 (1910) pp. 91-110 (figs.).

‡ Proc. Acad. Nat. Sci. Philadelphia, 1910, pp. 456-9 (pl.).

New Diatom.*—T. C. Palmer describes a new species of *Navicula* which is characterized by living always (so far as is known) in small groups of four. The frustules are joined girdle to girdle, so that the group as a whole moves about with four parallel raphes in approximate contact with the substratum, while four other parallel raphes are in evidence on the top. The connexions between the frustules are formed by a siliceous cementing of the edges of the valves. This peculiar habit of growth seems to be persistent, since no isolated specimens were found. It is much to be desired that the life-history of this diatom should be studied in order to understand the process of reduplication.

Bombay Characeæ.†—V. N. Hate gives an account of two species of *Chara* found in ponds by rice-fields at Matunga, on Bombay Island, during the rainy season. They are both monœcious. One of them is gritty and brittle, and grows associated with the somewhat similar aquatic plant, *Hydrilla verticillata*, and with *Oedogonium scutatum*, and is referred by Hate to *Chara verticulata* Roxb. The other is not gritty and brittle, and is referred to *C. flaccida* A. Br., which is very common in tanks and jheels in Bengal.

Cryptostomata and Conceptacles of *Fucus vesiculosus*.‡—M. Nordhansen discusses the hair-structures of the cryptostomata (Fasergrübchen) and conceptacles of *Fucus vesiculosus*. He describes the development of the cryptostomata from the young stages, as well as the two kinds of hairs which grow in them. The apical cells of the brown hairs produce mucilage. In the conceptacles there are two kinds of hairs (just as in the cryptostomata), and towards the middle the coloured hairs gradually pass into paraphyses. Many stages of the gradual transformation have been observed. This transformation is an additional argument for the homology between the cryptostoma and the conceptacles, but which is the older is unknown. The author endeavoured to cultivate the terminal cells of the coloured filaments in the cryptostomata, thinking that they might represent the asexual form of reproduction, but without success. He alludes to the more primitive cryptostomata of other brown algæ.

New *Batrachospermum*.—H. Kylin describes and figures a new species of *Batrachospermum*, collected by Skottsberg in a small brook in Tierra del Fuego. It forms the type of a new section of the genus to which the author gives the name *Skottsbergia*. The species *B. Skottsbergii* is distinguished from all other species of *Batrachospermum* by its cylindrical sessile trichogyne, and by the comparatively small gonimoblasts, several of which may occur in each joint. The carpospores differ in being elongate-pyriform.

Parasitic Floridææ.§—H. Eddelbüttel writes on the parasitic character of the so-called parasitic Floridææ, especially dealing with the genera *Choreocolax* Reinsch, and *Harveyella* Schm. & Reinke. Most

* Proc. Acad. Nat. Sci. Philadelphia, 1910, pp. 460-3 (pl.).

† Journ. Bombay Nat. Hist. Soc., xix. (1909) pp. 762-3.

‡ Ber. Deutsch. Bot. Gesell., xxviii. (1910) pp. 288-95 (figs.).

§ Svensk. Bot. Tidskr., iv. (1910) pp. 146-9 (pl.).

§ Bot. Zeit., lxxviii. (1910) pp. 186-92, 226-32.

of the genera described as parasitic among the Florideæ are but incompletely known, especially as regards their biology, and the only two genera which can rightly be named parasitic are the two above mentioned. Although the others show the strongly reduced thallus, which is a character of parasitism, they either show definite rhodoplasts, or are suspected of having such bodies. The following genera are therefore to be regarded as half-parasites, *Actinococcus* Kütz., *Ricardia* Derb. & Sol., *Melobesia* Lamouroux; while the parasitism of the following genera remains doubtful: *Gonimophyllum* Batters, *Janczewskia* Solms-Laubach, *Colawonema* Schmitz, *Colacodasya* Schmitz, *Choremema* Schmitz, *Ceratocolax* Rosenvinge, *Syringocolax* Reinsch, *Sterrocolax* Schmitz, *Episporium* Möbius. All these genera need further investigation. The author deals fully with *Choreocolax* and *Harveyella*, and finally discusses *Gracilariophila*, which he thinks is closely allied to *Choreocolax*, and is certainly a true parasite. This is a newly described genus parasitic on *Gracilaria*, and lately described by Setchell and Wilson. Eddelbüttel's paper is a good summary of all that is known on parasitic Florideæ.

Algæ of Auckland and Chatham Islands.*—R. M. Laing gives an account of the algæ collected during the 'Hinemoa' expedition to the islands lying south of New Zealand, namely, the Snares, and Auckland, Campbell, Antipodes, and Macquarie Islands. The list includes eighty-nine species and two new varieties. Critical notes are appended to many of the species.

Fungi.

(By A. LORRAIN SMITH, F.L.S.)

Formation of Oogonia in *Achlya*.†—P. Obel worked with *Achlya decorata*, a species which grows on sticks that have fallen into water—mostly in forest bogs. It develops well on animal substrata (flies and ant-eggs), or on vegetable (hemp-seeds), and, in these conditions, produces oogonia rather than zoosporangia. In pure water, zoosporangia were formed and very few oogonia. He tested the formation of the different organs in varying media, and records the results. Potassium phosphate furthers the formation of oogonia and of antheridia. The want of phosphate induces the formation of parthenospores. It has not been proved that these germinate.

Study of Heterothallic Mucorini.‡—Irène Korpatschewska found that the different sexual thalli in the Mucorini, though morphologically alike, reacted differently towards carbohydrates, certain substances being absorbed more easily by the + form, others by the - form. When the two forms were cultivated on the same substratum, sometimes one and sometimes the other showed the more vigorous growth. These physiological peculiarities were constant and were not modified by any external influence.

* Chilton, Subantarctic Islands of New Zealand. Wellington, N.Z., 1909, pp. 493-527 (4 pls.).

† Ann. Mycol., viii. (1910) pp. 421-3 (4 figs.).

‡ Bull. Soc. Bot. Genève, ser. 2, i. (1909) pp. 317-32. See also Bot. Centralbl., cxiv. (1910) pp. 192-3.

Endomyces on Apples.*—Ch. E. Lewis has isolated from decaying apples a species of *Endomyces* (*E. Mali*), which has been hitherto unknown in North America. It is only on ripe fruits that it is found, where it forms small rotten specks. The fungus was cultivated and compared with *E. Magnusii*. It differs from the latter in the absence of oidia, and in the abundant formation of asci. The minute size of the nuclei rendered cytological observations almost impossible.

New Species of Monascus.†—André Piedaller records another species of this rare genus of microscopic fungi. It grew in oil, said to come from Japan, and was cultivated on various media side by side with two other known species. Though closely allied, it differed from both in several particulars, and has been classified by the author as a new species, *Monascus olei*.

Sphærosoma.‡—W. A. Setchell has written a review of this genus, dividing it into three groups: (1) *Sphærosoma*, including those species with echinulate spores; (2) *Sphærozone*, with warted spores; and (3) *Rublandiella*, in which the spores have a netted epispore. The Californian species included in these groups are described by the author.

New Lancashire Cryptogams.§—J. A. Wheldon records two interesting finds for the county, *Cyathipodium corium*, an elegant stalked black fungus, shaped when young like a miniature champagne-glass, and *Sphaerospora trechispora* var. *puludicola* Boud. Both of these fungi were determined by Boudier, the eminent French mycologist.

Development of Gnomonia erythrostoma.||—F. T. Brooks publishes the results of his research on this fungus, which causes cherry leaf scorch, a disease that has done much damage in the cherry orchards of Kent. The fungus remains on the withered leaves during the winter, and reinfects the young leaves in spring. An attempt was made to convey the disease to Cambridge, but though several leaves were infected, a sufficient quantity could not thus be obtained for research, and material was then obtained in Kent. Trees that have suffered from the disease for years have had their vigour much impaired, the yield of fruit being scanty and the cherries hard and not properly ripened. Early stages were difficult to find, but were finally detected as yellowish spots near the midrib, which, on sectioning, showed the characteristic *Gnomonia* mycelium.

Brooks first describes the spermogonia, which occurred in great numbers on the under side of the leaf, and resemble those of Uredineæ. The spermatia are long and thread-like, and possess the cytological characters of male cells. There was no evidence of fertilization, and they may be considered as functionless; it was not found possible to induce the spermatia to germinate. The perithecia are also formed on

* Maine Agric. Exper. Stat., Bull. No. 178 (1910) pp. 45–64 (7 pls.). See also Ann. Mycol., viii. (1910) p. 487.

† Comptes Rendus, cli. (1910) pp. 397–9.

‡ Univ. California Publications (Bot.) iv. 5 (1910) pp. 107–20 (1 pl.). See also Bot. Zeit., lxxviii. (1910) pp. 197–8.

§ Lancashire Naturalist, iii. (1910) p. 83.

|| Ann. Bot., xxiv. (1910) pp. 585–605 (2 pls.).

the under side of the leaf: a coil of cells near the epidermis, with certain hyphæ which project from a stoma—the trichogynes. Spermata were seen in considerable numbers attached to the end cells of the trichogynes, but no fusion was ever observed—the end cell of the trichogyne was often seen to show signs of disorganization as soon as it emerged from the stoma. It is suggested that these trichogynes, though originally receptive, have now probably a respiratory function. The development of the perithecia from the coil was observed and is fully described, but it was not possible to trace the ascogonia. The only nuclear fusion observed takes place in the ascus. Nuclear division was followed in the ascus, and reduction was observed in the first division. A second division followed rapidly, showing analogies with meiosis rather than with brachymeiosis. The first formed four nuclei rest for some time before undergoing division to form the eight spores—no reduction was visible at this stage, but the single reduction observed is held to tally with the single fusion that took place in the ascus. A general review of the nature of spermogonia and trichogynes follows.

Whitening of the Mountain Cedar, *Sabina sabinoides*.*—F. D. Heald and F. A. Wolf describe the disease of the cedar, which is characterized by whitened areas on the trunks and branches of the affected trees. The disease is so common that the white areas have been considered a diagnostic character of this cedar. On the whitened areas are found stromatic nodules, singly or in small groups, which vary in length from 1 mm. to 2.25 mm. One to three perithecia are embedded in each nodule, and their ostioles project as small papillæ; the asci contain six or eight filamentous, multiseptate, very long spores, generally curved or twisted. The fungus occurs most abundantly on the younger twigs and on young trees; it surrounds them and destroys the cambium layer. The fungus has been named *Cyanospora albicedræ* g. et sp. n., and has been placed in the family Ceratostomaceæ.

Mildew of Apples.†—J. Eriksson discusses chiefly the occurrence of the mildew in Sweden, where it has only recently been detected, and was probably imported from France. It is particularly harmful to young plants, but it also attacks full-grown trees, and may be found on pear trees, especially on the fruit. Eriksson gives a list of the varieties attacked, and of those that proved immune. As preventive measures, he recommends the collecting and burning of all shoots that are diseased, and the spraying of the trees after the leaves have fallen, with Bordeaux mixture, the spraying to be repeated in spring.

American Gooseberry Mildew.—J. Eriksson ‡ discusses the question of immunity of different varieties of gooseberry bushes to the attack of *Sphærotheca mors-uvæ*. The American mountain gooseberry was not quite immune, but proved very little liable to the disease, and he thinks

* Mycologia, ii. (1910) pp. 205-12 (1 pl. and 3 figs.).

† Prakt. Bl. Pflanzenb. Pflanzensch., 1909, pp. 73-7, 96-9. See also Zeitschr. Pflanzenkr., xx. (1910) pp. 362-3.

‡ Deutsche Obstbauz. (1909) 1 p. See also Zeitschr. Pflanzenkr., xx. (1910) pp. 363-4.

it might be used with advantage in cultivating disease-proof bushes. The whole problem is worthy of serious consideration.

A. Lemcke* gives an account of the same disease in East Prussia. It was reported from 962 localities, and in some districts had completely destroyed all the gooseberries. He gives the best methods of dealing with the disease, and also gives a list of gooseberry varieties that are immune and less susceptible to the disease.

Oak Mildew.—Ed. Fischer† records the spread of this disease in Switzerland, where it occurred most frequently on *Quercus pedunculata*, *Q. sessiliflora*, and *Q. pubescens*. The author thinks it is possibly a species of *Microsphaera*, which has been a long time in the country, and, for some unexplained reason, has suddenly become epidemic, or possibly some American species that has been introduced.

E. Barsali‡ records its appearance in Italy, where it was first observed in 1907, near Livorno, chiefly in damp situations. In a short time the disease spread to the other oaks in the neighbourhood.

Notes on Yeast-cells.§—A. Guilliermond records a somewhat curious phenomenon observed in the cells of *Debaryomyces globulosus*. In that species spore-formation takes place after copulation of two cells. The author noted many instances in which spore-formation took place without such previous fusion, but the fertile cells formed a small beak-like outgrowth exactly similar to the fusing-cells. In *Schwanniomyces occidentalis* there is never any copulation of cells; but there the beak-like outgrowth is also formed, pointing, Guilliermond considers, to an earlier ancestral condition when fusion preceded spore-formation.

Red Yeast.||—E. Pringsheim and H. Bilewsky have made a study of the life-history of this yeast distinguished by the reddish colour of the cells. The authors have finally defined it as *Torula glutinis*, the specific name having been originally given to it from its growing frequently on starch-paste. It is never found on living vegetation, but is easily cultivable on cooked fruits, potatoes, etc. It was cultivated successfully on a variety of artificial media, but spore-cells have never been detected, and for this reason the authors have decided that it belongs to the genus *Torula* rather than to *Saccharomyces*. It has been frequently described as fouling milk, butter, etc.

Uredineæ.—A. von Jaczewski¶ publishes a German translation of his Russian paper on the black rust of cereals, *Puccinia graminis*, which is the cause of widespread damage in Russia. He describes the germination of the stylospores, and their failure to infect the host-plant. Æcidiospores were also freely cultivated, and their germination followed. Æcidia grew not only on *Berberis vulgaris*, but also on several other

* Arb. Landw. Prov. Ostpreussen, No. 24 (1909) pp. 1–33. See also Zeitschr. Pflanzenkr., xx. (1910) pp. 363–4.

† Schweiz. Zeitschr. Forstwesen, 1909. See also Zeitschr. Pflanzenkr., xx. 1910, p. 364.

‡ Bull. Soc. Bot. Ital., 1909. See also Zeitschr. Pflanzenkr., xx. (1910) pp. 344–5.

§ C.R. Soc. Biol. Paris, lxxviii. (1910) pp. 363–5 (2 figs.). See also Ann. Mycol., viii. (1910) p. 487.

|| Beitr. Biol. Pflanz., x. (1910) pp. 118–32 (1 pl.).

¶ Zeitschr. Pflanzenkr., xx. (1910) pp. 321–59 (8 figs.).

species, and were frequently found on *Mahonia* plants. The aëdiospores retain their germinating capacity three weeks or a month, but they are killed by sudden drying. The spores form a germinating tube which travels towards the nearest stoma, and enters the tissue of the plant, where it branches and forms a felt of mycelium. The author further describes the occurrence and germination of uredospores and telentospores, and combats Eriksson's mycoplasma theory. He considers that the disease may be very well accounted for by the telentospores alone, and only climatic conditions prevent the wintering of uredospores. He further tested Eriksson's theory by growing seeds of rusted corn after treatment with formalin: the seedling and mature plant were equally free from rust. Finally, the specialization of rust on different grasses is discussed.

Two new species* of the genus *Phakospora* are published by P. Dietel. They were sent to him from India by E. J. Butler. The uredo-form of one of them had already been described from Japan; the other, *P. Phyllanthi* on *Phyllanthus distichus* is entirely new, and both uredospores and telentospores were found.

J. C. Arthur† reports on the cultures of Uredineæ carried out during the year 1909 by himself and other associated workers. Excursions were made for culture material to South Carolina, St. Louis, and Leland in Michigan. The records include fourteen cultures that gave negative results, twenty-three with positive results on plants that had already been experimented with, and four cultures of new material, including three new species. The successful cultures were:—*Puccinia Ceanothi*, with telentospores on *Andropogon Hallii*; *Gymnosporangium exiguum* sp. n. on *Cratægus Pringlei*, the telentospores on *Juniperus virginiana*; *Gymnosporangium cornicularis* sp. n. on *Amelanchier erecta* and *A. canadensis*, the telentospores on *Juniperis horizontalis*; *Gymnosporangium trachysorum* sp. n. on *Cratægus punctatu*, *C. roccinea*, *C. cernonis*, with telentospores on *Juniperus virginiana*.

New Genus of Uredinaceæ.‡—E. J. Butler describes this rust, *Cystospora Oleæ* g. et sp. n., which occurs as little white dots on orange spots of the leaves of *Olea dioica* in Bombay. In the telentospore stage a strand of hyphæ passes out of the infected leaf through a stoma; they then form large irregular basal cells from which arise the telentospores, one-celled and spherical. An *Aecidium* was found on some of the specimens almost wholly sunken in the leaf, then opening by a stellate or roundish orifice; no spermogonia were observed, and no uredospores.

Wood-destroying Fungi.§—Konstantin Ilkewitsch has published a long criticism of Falck's researches on this subject, insisting that many mistakes have been made. He divides the errors he has noted into three categories: (1) Errors in observation; (2) in method; and (3) in the presentation of facts and in the theories drawn therefrom. A long list of errors is set out under these different headings, and then the writer proceeds to support his contentions. His adverse criticism practically embraces the whole of Falck's results.

* Ann. Mycol., viii. (1910) p. 469.

† Mycologia, ii. (1910) pp. 213-40.

‡ Ann. Mycol., viii. (1910) pp. 444-8 (1 pl.).

§ Bot. Zeit., xi. (1910) pp. 101-23.

Ernst Schaffnit* has also studied this subject with special reference to the different species of *Merulius*. He found specimens of *Merulius* on a post which he cultivated and found to correspond with *M. domesticus*, though it grew in the open; it retained the same characters for seven years, and Schaffnit concludes that the two species, *M. domesticus* and *M. silvester*, are well differentiated.

J. Schorstein† has written on *Merulius lacrymans* and its allies. He gives three leading species, *M. lacrymans*, *M. pulverulentus*, and *M. squalidus*. He gives spore measurements, and notes that they do not agree with those recorded by Falck.

Key to the British Agaricaceæ.‡—H. J. Wheldon has drawn up a key on the same system as that employed by H. N. Dixon in the Handbook of British Mosses. Instructions are given to the collector both how to gather and how to examine the specimens. A key to the species follows that to the genera.

German Fungus Flora.§—W. Migula describes the genera and species of the Auriculariales and of the Tremellineæ, which finishes the first division of Basidiomycetes. He then begins the second great group of Antobasidiomycetes, divided into eight sub-groups, in which he includes the Gasteromycetes. Full descriptions are given of all the species. Five coloured plates—irrespective of the text—are published with each fascicle.

Fairy Rings.||—Jean Massart finds that most of the cases of Fairy-ring growths in Belgium are due to *Marasmius oreades*. He calls attention to the sterility as regards fungus growth of the ground enclosed by the ring, and also points out that where two rings meet no fungi grow at the point of contact. He argues from analogy with higher plants, that probably the mycelium excretes some poison that is fatal to further fungal growth, though not to the growth of higher plants.

Notes on Larger Fungi.—Coloured plates¶ of two poisonous Agarics are published by the Board of Agriculture. They are the well-known Fly Agaric, *Amanita muscaria*, and a less common species, *Lepiota clypeolaria*. Short descriptions of the fungi are given.

H. Bourdot** has published a list of Corticeæ from the Bourbonnais and the Central Provinces of France. He remarks on the difficulty in distinguishing and differentiating the species. Several new species are described.

Joh. Ruys †† has published a book on Dutch Fungi, *De Paddenstoelen*

* Ber. Deutsch. Bot. Gesell., xxviii. (1910) pp. 200-2.

† Oesterr. Bot. Zeitschr., lx. 3 (1910) pp. 112-14. See also Bot. Centralbl., cxiv. (1910) p. 244.

‡ Lancashire Naturalist, ii. (1910) pp. 335-8 (5 figs.), 361-4 (2 figs.); iii. pp. 23-6, 53-6, 89-90, 119-22 (9 figs.).

§ Flora von Deutschland, v. lief. 97-8 (1910) pp. 1-32.

|| Ann. Jard. Bot. Buitenzorg, supp. 3, pt. 2 (1910) pp. 583-6.

¶ Journ. Board Agric., xvii. (1910) pp. 387-8 (2 col. pls.).

** Rev. Sci. Bourb. Centr. France, xxiii. (1910) p. 13. See also Ann. Mycol., viii. (1910) p. 480.

†† Gravenhage: M. Nijhoff (1909) 461 pp. (126 figs.). See also Ann. Mycol., viii. (1910) p. 482.

van Nederland. Only the larger fungi, the Agarics, Polypores and Gasteromycetes, with a few Ascomycetes, are included in the survey. No microscopic details are given.

British Basidiomycetes.*—M. C. Cooke has issued a list of the larger fungi, of a convenient size for carrying in the field, and with alternate blank pages for making notes. The genera are numbered—134 in all—and also indexed. A slight key to genera and species is supplied, and “poisonous” or “edible” added to outstanding species. The list includes the species recorded up to the end of 1908.

Notes on Microfungi.—H. S. Fawcett † points out a confusion that has arisen concerning the species of *Cladosporium* that causes a scab on the orange, and has been described as *C. Citri* Mass. It is distinct from *C. elegans* Penz., which forms arid brown spots on the leaves.

W. C. Coker ‡ records a new host for *Exoascus filicinus*. He found it growing on the Christmas fern, *Dryopteris acrostichoides*.

Study of Fumagine Fungi.—G. Arnaud§ describes these as fungi differing from each other, but all connected with one group of Sphæriaceæ. This group, representing the perfect form of the fungus, includes *Capnodium*, which is synonymous with *Teichospora*, *Pleosphaeria* and *Seuratia*. The conidial forms are *Dematium*, *Cladosporium*, *Alternaria*, *Macrosporium*, and *Triposporium*. Arnaud has made culture experiments with the different forms, and the results are to be published in a future number of the Annales.

Popular Account of Fungi.—Julius Rothmayr || is publishing monthly a periodical, called “der Pilzfreund,” or the Fungus-lover. The aim of the paper is to interest people in the most important economic species, to enable them to distinguish the edible from the poisonous species, and to instruct them where and how to collect specimens. There are papers on these various subjects by several authors. The editor writes on “Arrangements of Fungi in their families”; “Is the Panther fungus (*Amanita umbrina*) edible or poisonous?”; “What Fungi may we expect to find in April”; and several other papers by Ed. Wiedenbach, B. Studen, and A. W. Holl.

The author ¶ has also published a popular account of edible and poisonous Swiss Fungi in book form. He describes *Amanita pantherina* as poisonous, *A. muscaria* as unpleasant, but not poisonous.

Plea for the Study of Fungi.—Thos. Smith ** emphasizes the interest to the student of the various forms of fungoid plant-life, and points out the great differences between these and other members of the vegetable kingdom. He sketches the structure and development of the larger fungi, and describes the methods of classification. He pays

* Catalogue and Field-book of British Basidiomycetes.

† Mycologia, ii. (1910) pp. 245-6.

‡ Tom. cit., p. 247.

§ Ann. Mycol., xiii. (1910) pp. 470-6.

|| Der Pilzfreund. Luzern (April 1910) i. See also Bot. Centralbl., cxiv. (1910) pp. 219-20.

¶ Luzern: (1909) 119 pp. (40 col. pls.). See also Bot. Centralbl., cxiv. (1910) p. 220.

** Lancashire Naturalist, ii. (1910) pp. 369-72: iii. pp. 3-6, 59-63, 73-4.

special attention to the edible and poisonous species, and gives a descriptive list of the principal forms.

Edible Fungi.*—Marius Grandjean gives a report of the fungi offered for sale at Lucerne during the season of 1909 from May to December. A large number of species, 106 in all, were brought for inspection: 15 were poisonous, 13 suspect, and 78 edible. The different lists are published.

Poisonous Fungi.—Ed. Butignot† describes a case of poisoning in Switzerland from eating *Clitocybe geotropa*, which was severe, but not fatal. The fungi had been collected ten days previously, and the trouble was probably due to their age.

An account‡ of three poisonous species has been published by the Board of Agriculture. They are: *Volvaria gloiocephala*, *Cortinarius purpurascens*, and *Stropharia æruginosa*, the last-named by far the commonest and very easily determined on account of the verdigris colour of the cap.

W. W. Ford§ writes on the distribution of poisons in mushrooms, of the active principle in each poisonous species, and of its physiological reactions. He considers that chemical examination should be sufficient to detect the toxin properties of the plants.

Relations between Callose and Fungose.||—C. Tauret refuses to accept Mangin's view that the chitine of fungi is of the same quality as callose. Tauret proves by the different reactions to alkali of the two substances that there is a very considerable difference, and as the one is termed callose, he gives to the substance derived from fungi the title fungose. He holds that callose, which is insoluble in alkalis, must be a much more complex body than fungose, which is soluble.

Resistance of Vegetable Tyrosinases to High Temperatures.¶—G. Bertrand and Rosenblatt have made a series of experiments on these substances derived from several of the higher plants, and also from fungi. They find that those obtained from fungi, species of *Amanita*, *Tricholoma*, *Lactarius*, *Russula*, *Hypholoma*, etc., are destroyed at a lower temperature than those extracted from the higher plants. They explain their method of working, and caution experimenters against generalizing too lightly on the qualities of such substances without verifying their origin.

Nuclear Phenomena of Sexual Reproduction in Fungi.**—R. A. Harper has reviewed the work done on this subject in recent years, and sums up the facts established thus:—1. The fusion of multinucleated gametes. 2. The male element may be a mass of gonoplasm, rather than a definitely bounded cell. 3. Endokaryogamy, the fusion of nuclei

* Bull. Soc. Mycol. France, xxvi. (1910) pp. 269-71.

† Tom. cit., pp. 266-8.

‡ Journ. Board Agric., xvii. (1910) pp. 475-6 (3 col. pls.).

§ Science, n.s. xxx. (1909) pp. 97-108. See also Bot. Centralbl., cxiv. (1910) p. 327.

|| Comptes Rendus, cli. (1910) pp. 447-9.

¶ Ann. Inst. Pasteur, xxiv. (1910) pp. 653-7.

** Amer. Nat., xlv. (1910) pp. 533-46.

not brought together by cell fusion, but of more or less independent ancestry. 4. The fusion of gametes without the fusion of their nuclei, the latter reproducing by conjugate division for long series of cell generations, and finally fusing just before the reduction division. 5. Fertilization by nuclear migration from a vegetative cell to an egg or fertile cell. 6. Two successive fusions in the same life cycle, a normal conjugation of gametes and later endokaryogamy.

Plant Diseases.*—F. von Faber describes galls on the roots of seedlings of *Kickxia elastica*, that destroyed them. Microscopical examination showed that the galls were caused by a fungus which evidently excreted some poison that caused the cells to swell up to an enormous size and form galls. It was impossible to classify the fungus, as no fruit was formed.

F. Guegnen † describes a disease of the fruits of cacao caused by a mould, the infection having been conveyed by an insect which had bored into the fruit. The fungus is nearly related to *Acrostalagmus*; occasionally it enters the fruit along with the pollen tubes. The seeds are not affected internally, but they are overgrown by the mycelium of the fungus.

Keith Bancroft ‡ has published, in book form, an account of the fungoid diseases of tropical plants, more especially of those that occur in the West Indies. Diagnoses and general descriptions of the fungi are given, and references to original literature bearing on them. In the introduction Bancroft discusses the various methods of treating disease.

G. Lüstner § writes of the damage done to apples and pears by the mildew *Podospheera leucotricha* Salm. It was first detected by Sorauer in 1884, since then it has spread widely: it destroys the young shoots and leaves of apple trees. It spreads over the whole branch in pear trees, and in some species attacks the fruit. Pruning the diseased branches is strongly recommended.

A. Naumann ¶ reports several fungoid diseases of rhododendron, *Physalospora Rhododendri* sp. n., which causes the leaves to wither from midrib outwards, and *Exobasidium*, which was found forming the characteristic galls on Azaleas. It resembled strongly *E. Vaccinii*.

A disease of strawberry ¶ leaves due to *Ramularia Tulasnei* is described in the Journal of the Board of Agriculture. It forms spots on the leaves, and considerably weakens the foliage. The perfect fruiting form was unknown for a long time, but has now been determined as *Sphærella Fragariæ*, a minute Pyrenomycete. Spraying is recommended to check the disease.

Emile Mer ** publishes a long series of notes on the growth and development of *Lophodermium macrosporum* on the needles of *Epicea*,

* Ann. Mycol., viii. (1910) pp. 449-51 (1 fig.).

† C.R. Soc. Biol. Paris, lxxviii. (1910) pp. 221-22. See also Ann. Mycol., viii. (1910) p. 485.

‡ Handbook of the Fungus Diseases of West Indian Plants, 70 pp. (6 pls.).

§ Jahresh. Ver. Angew. Bot., vii. (1909) pp. 106-11. See also Ann. Mycol., viii. (1910) p. 484.

¶ Tom. cit., pp. 181-8. See also Ann. Mycol., viii. (1910) p. 484.

¶ Journ. Board Agric., xvii. (1910) pp. 476-7 (pl.).

** Rev. Gén. Bot., xxii. (1910) pp. 297-335.

of which it is a destructive parasite. The fungus attacks leaves of more or less weakened vegetation. Those of the current year are usually free from the parasite. The needle is penetrated through and through by the mycelium, which induces the formation of resin and tannin, and causes brown or black spots and rings on the surface. The attack occurs usually in May, but the perithecia of the fungus do not mature until the following May. The ripening of the spores may be delayed until September, or even till the following spring, and in that case the development of the fungus lasts more than a year.

F. A. Wolf* describes a leaf-blight of the American Mistletoe (*Phoradendron flavescens*). The disease manifests itself by chlorosis of parts or the whole of the leaf, then the affected foliage becomes dark brown and dead. The pycnidia of the fungus, *Macrophoma Phoradendri* sp.n. are scattered on both leaf surfaces.

Leaflets have been issued by the Board of Agriculture giving information about various diseases:—

1. As to cucumber and tomato canker † caused by *Mycosphærella citrullina*, first indicated by the wilting of the leaves. The fructification of the fungus is to be found on the nodes of the stem. Thorough spraying with Bordeaux mixture checks the disease.

2. Leaf-shedding in Conifers ‡ due to *Botrytis cinerea* is described, also making its appearance in yellowing leaves. Leaves and shoots attacked fall to the ground. Spraying is recommended, and the destruction of dead leaves, etc.

3. Leaf-disease of celery § is figured and described. It is due to a minute fungus, *Phyllosticta Apii*, which forms blotches on the leaves, at first a dull brown, later somewhat paler. The disease appeared in Sussex in 1909, and caused much damage.

Max Britzelmayer.|| — This fungologist and lichenologist died at Augsburg in December 1909 at the age of 71 years. He was a teacher by profession, but devoted much of his spare time to the study of the Fungi and Lichens of Bavaria. A note on his life and work, with a list of his publications, is published by L. Gerstlauer, with a photograph.

BOYD, D. A.—**Microfungi observed at Traquair and Roslin.**

[A list of seventy species found and determined by the collector.]

Trans. Edinburgh Field Nat. Soc., vi. (1909) pp. 149–52.

BOURDOT, H., & A. GALZIN.—**Hymenomycetes de France.** (II. Homobasidiæ: Clavariæ and Cyphellæ.)

[Seventy-four species are described.]

Bull. Soc. Mycol. France, xxvi. (1910) pp. 210–28.

BUBAK, F.—**Fungi in Ergebnisse einer botanischen Reise in das Pontische Randgebirge.** (Fungi “in the results of a botanical journey in the Pontische Randgebirge.”)

[Many new species are described, and one new genus, *Chætasterina* (Microthyriaceæ).] *Ann. k.k. Nat. Hist. Hofmus. Wien*, xxiii. (1909) pp. 101–7.

See also *Bot. Centralbl.*, cxiv. (1910) pp. 243–4.

* *Mycologia*, ii. (1910) pp. 241–4 (1 pl.).

† Board of Agriculture and Fisheries, Leaflet No. 230 (1910) 2 pp. (pl.).

‡ *Op. cit.*, No. 234, 2 pp. (pl.).

§ *Op. cit.*, No. 238, 2 pp. (6 figs.).

|| *Ber. Bay. Bot. Ges.*, xii. (1910) pp. 69–72.

- CAMARA, DE SANZA, & A. CANNAS MENDES—*Mycetæ aliquot et insecta pauca Theobromæ cacao in Sancti Thomensis insula.* (Some fungi and a few insects on *Theobroma cacao* in the island of St. Thomas.)
[A number of new species are described.] Lissabon: (1910) 8 pp. (6 pls.).
See also *Ann. Mycol.*, viii. (1910) p. 481.
- FISCHER, ED.—*Die Fruchtkörper-Entwicklung von Aseroë.* (Development of the fruiting-body in the genus *Aseroë*.)
Ann. Jard. Bot. Buitenzorg, suppl. 3, pt. 2 (1910) pp. 595-614 (2 pls.).
- GUILLIERMOND, A.—*Remarques sur le développement de l'Endomyces fibuliger.* (Remarks on the development of *Endomyces fibuliger*.)
[Results of cultural experiments with the spores.]
C.R. Soc. Biol. Paris, lxxviii. (1910) pp. 318-20.
See also *Ann. Mycol.*, viii. (1910) p. 487.
- HARIOT, P., & N. PATOUILLARD.—*Champignons de la région de Tombouctou et de la Mauritanie, recueillis par M. R. Chudeau.* (Fungi from the region of Timbuctoo and Mauritania collected by R. Chudeau.)
[Several new species are described.]
Bull. Soc. Mycol. France, xxvi. (1910) pp. 205-9 (1 pl.).
- HÖHNEL, F. VON, & JOSEF WEESE—*Zur Synonymie in der Gattung Nectria.* (Synonymy in the genus *Nectria*.)
[A list of many species that have been wrongly named.]
Ann. Mycol., viii. (1910) pp. 464-8.
- KRUYFF, E. DE.—*Torula bogoriensis-rubra* sp. n.
[A red-celled form studied in cultures and described.]
Ann. Jard. Bot. Buitenzorg, suppl. 3, pt. 1 (1910) pp. 93-6.
- LINDAU, G.—*Hyphomycetes.*
[The fascicle contains lists of host-plants and index.]
Rabenhorst's Kryptogamen-flora, Abt. 9, lief. 119.
(Leipzig, 1910), pp. 881-944.
- „ „ *List of Fungi from the Sub-antarctic Islands of New Zealand.*
[Collected by the members of an expedition to these islands.]
Wellington, N.Z.: John Mackay (1909) ii. pp. 529-30.
- MAIRE, LOUIS—*Études Mycologiques sur l'arrondissement de Gray.* (Mycological studies in the Arrondissement of Gray.)
[A list of species of the larger fungi, with notes.]
Bull. Soc. Mycol. France, xxvi. (1910) pp. 229-65.
- MAIRE, RENÉ—*Notes Critiques sur quelques champignons.* (Critical notes on some fungi collected during the Dijon Meeting of the French Mycological Society.)
[Some new species and varieties are included.]
Bull. Soc. Mycol. France, xxvi. (1910) pp. 159-98 (10 figs.).
- MARTIN, CH. ED.—*Herborisation mycologique der 17 Octobre, 1909, au Mont-Mussey (Aix).* (Mycological foray at Mont-Mussy.)
[107 species were collected; one new variety, *Clavaria cristata* var. *microspora*.]
Bull. Soc. Bot. Genève, sér. 2, i. (1910) pp. 290-3.
See also *Bot. Centralbl.*, cxiv. (1910) p. 220.
- MASSEE, G.—*List of Cryptogams from the Subantarctic Islands of New Zealand.*
[Several fungi and one lichen, collected by the members of an expedition to these islands.]
Wellington, N.Z.: John Mackay (1909) ii. pp. 528-9.
- MURRILL, W. A.—*A new Boletus from Mexico, Ceriomyces jalapensis.*
[Collected near Jalapa, Mexico.]
Mycologia, ii. (1910) p. 248.
- PATOUILLARD, N.—*Notes sur trois espèces d'Hydnangium.* (Notes on three species of *Hydnangium* from the flora of the Jura.)
Bull. Soc. Mycol. France, xxvi. (1910) pp. 199-204 (3 figs.).
- PECK, CH. H.—*Report of the State Botanist (1909).*
[A number of new fungi are included in the Report.]
New York State Museum, Bull. No. 139 (1910) 114 pp. (2 pls.).
See also *Ann. Mycol.*, viii. (1910) p. 481.

PEGLION, VITTORIO.—**Intorno alla carie del frumento.** (Concerning smut of wheat.)

[Notes on infection of wheat by *Tilletia levis*.]

Atti Reale Accad. Lincei, cccvii. (1910) pp. 216–20.

SYDOW, H. & P.—**Fungi Philippenses.**

[List of species from the Philippine Islands.]

Phil. Journ. Sci., v. (1910) pp. 163–6.

THEISZEN, F.—**Fragmenta brasílica. III.**

[Diagnoses are given of many species from Brazil, a number of them new.]

Ann. Mycol., viii. (1910) pp. 452–63 (6 figs.).

WHELDON, HAROLD J.—**A Contribution to the Manx Fungus-flora.**

[A list of species, with localities.]

Lancashire Naturalist, ii. (1909) pp. 195–9.

Lichens.

(By A. LORRAIN SMITH.)

Study of the Lichens of Dunkerque.*—M. Bouly de Lesdain has made an exhaustive study of the Lichen flora of the Dunkerque region. He gives the species that are to be found on the various shore elevations below and above high-water mark, and those that grow on the dunes along with other Cryptogams and higher plants with which they are associated. He also gives the trees of the region and the lichens he has found growing on them. The latter part of the book includes a full descriptive list of the genera and species and a list of fungi parasitic on the lichens.

Variation of Gonidia in the Genus *Solorina*.†—Hue finds two types of gonidia in *Solorina*, belonging respectively to the Phycobryales (*S. sinensis*, *S. sorediifera*, etc.) and Chlorophyceae (*S. saccata*, *S. spongiosa*, etc.) In the latter group he finds colonies of *Nostoc* forming endogenous cephalodia which are looked on as thalli adventitious to the principal thallus. In *Solorina crocea* he finds at the base of the cortex a band of small gonidia (Chlorophyceae) of irregular growth, rising in pyramids towards the upper surface; beneath this layer other gonidia (Nostocaceae) forming glomerula, and finally an uninterrupted layer. These two zones are usually separated by a layer of hyphae, but occasionally they are in contact and both may be present in the apothecium. Specimens of *S. crocea* do not differ in structure no matter where collected. Hue considers that both types of gonidia aid in the nutrition of the lichen. In *S. spongiosa* and *S. bispora* he finds attached to the normal thallus small scales containing *Nostoc* and forming subsidiary homoiomeros thalli; they rise above the normal thallus in the form of small scales, and this growth is further aided by the germination of *Solorina* spores which produce hyphae among which may be seen colonies of *Nostoc*. These scales are cephalodia and Hue proposes for them the title of "thalliform," rather than pseudocephalodia, the name given to them by Forssell.

Epiphytic Lichens.‡—Hans Fitting has studied the epiphytic lichen *Mycoidea parasitica* on leaves in Java. It is preceded on the leaf

* Recherches sur les Lichens des environs de Dunkerque. Publication de la Société Dunkerquoise, 301 pp. (4 pls.)

† Comptes Rendus. cli. (1910) pp. 332–4.

‡ Ann. Jard. Bot. Buitenzorg, suppl. 3, pt. 2 (1910) pp. 505–18. See also Bot. Zeit. lxxviii. (1910) pp. 198–9.

by the parasitic chroolepoid alga *Cephaleuros Mycoidea*, which lives on the surface of tropical evergreen leaves. As the alga becomes older it penetrates the cuticle and the outer epidermal wall, and even further into the tissues, the host-cells affected becoming brown. The epiphyte is transformed into the lichen by the growth of hyphal fungi among the algal cells; its behaviour in regard to the leaf is the same as that of the alga alone. On the whole the leaf is very slightly damaged. Fitting discusses the climatic conditions that favour the growth of both alga and lichens, and the kinds of leaves that are more especially the hosts of *Cephaleuros* and *Mycoidea*.

New Lancashire Cryptogams.*—J. A. Wheldon notifies the collection of several interesting specimens of lichens: a form of *Levidea cupularis* that is probably var. *marmorea*, as it has an entire margin: *Arthopyrenia areaiseda*, a new lichen from the sea-shore near Formby; and specimens of *Polyblastia hymenogonia*, a rare plant found on a mortared wall.

Lichens of Minnesota.†—Bruce Fink has been for many years investigating the lichen-flora round Miami, and he now publishes in volume form the results of his work. In the introduction he gives an account of the morphology, physiology, and ecology of the group, with an historical sketch of work done on the lichens. The larger part of the book is occupied by a descriptive catalogue of the plants found by him. The book is well illustrated by photographic plates and figures.

LINDAU, G.—**List of Lichens from the Sub-Antarctic Islands of New Zealand.**

[Collected by the members of an expedition to these Islands.]

Wellington, N.Z.: John Mackay (1909) ii. pp. 530-2.

LESDAIN, BOULY DE—**Lichens belges rares ou nouveaux.** (New or rare Belgian Lichens.)

[A number of species are listed, one new to science. Notes and occasional descriptions accompany the species.]

Bull. Soc. Roy. Bot. Belg., xlvii. 1 (1910) pp. 39-45.

See also *Bot. Centralbl.*, cxiv. (1910) p. 198.

STANSFIELD, A.—**Flora of Todmorden, Order IV., Lichens.**

[A number of interesting species are listed.]

Lancashire Naturalist, ii. (1910) pp. 357-60.

Mycetozoa.

(By A. LORRAIN SMITH.)

Mycetozoa of Pictou County.‡—Clarence L. Moore has made a study of these organisms in Nova Scotia during the summers of 1905-6, and now publishes the result of his researches. He gives a popular account of the history of the group and a description of the life processes. He also presents the different forms of classification adopted by the leading workers in this group. Finally he gives a descriptive list of all the genera and species recorded from Pictou county.

* *Lancashire Naturalist*, iii. (1910) p. 82.

† *Contributions U.S. Nat. Herb.*, xiv. 1 (Washington, 1910) xvii. and 269 pp. (51 pls. 18 figs.).

‡ *Proc. Trans. Nova-Scotian Inst. Sci.* xii. (1910) pp. 165-206 (4 pls.).

Schizophyta.**Schizomycetes.**

Scientific Cheese-making.*—In the concluding instalment of his review of this subject, P. Mazé gives a classification of the different kinds of cheese, and prescribes the applications suitable for each class of the scientific principles previously discussed. Then follow general conclusions, in which emphasis is given to the importance of selecting suitable lactic ferments, maintaining a correct reaction and avoiding contaminations. The manufacture of cheese is for the most part carried out upon traditional and empirical lines. It is time that such methods should give place to more scientific procedures.

Rennet-forming Cocci in Cheese.†—C. Gorini assigns to these bacteria an important role in the maturation of certain varieties of cheese. The diagnosis of these forms should depend upon their action on milk, and it is important to verify their power to attack casein in an acid medium. The action upon gelatin serves to divide this group into two classes, namely, *Micrococcus casei acido-proteolyticus* I, which liquefies, and *M. casei acido-proteolyticus* I, which does not liquefy gelatin.

Bacterial Flora of Rachitic Stools.‡—R. Greig-Smith has made bacteriological examinations of fæces from a number of rickety children. Nineteen varieties allied to, or identical with *B. coli communis* were isolated, but these forms differed in no way from those found in the stools of healthy children. Streptococci, principally of the types *S. salivarius* and *S. acidilactici* were, however, obtained more frequently from rachitic than from normal persons. These forms can survive and multiply in more strongly acid fluids than can the intestinal bacilli, and have been found normally to predominate in higher portions of the alimentary tract. The author considers that the greater frequency of their occurrence in the fæces of rickety children may be associated with an acid condition of the contents of the large intestine.

Slime Bacteria on Sponges.§—The slime that forms upon household sponges is usually attributed to accumulation of soap, epithelial debris, and other materials. but R. Greig-Smith, upon examining stained films, found that it was crowded with bacteria. Cultivation yielded a great variety of organisms, such as *Radiobacter*, *Sarcinæ*, and *Rhizobia*. Two slime-bacteria of the latter class were further investigated. Both types produced luxuriant slimes when grown upon media containing saccharose, levulose, or certain other sugars, but did not respond to lactose or dextrin. With Bacillus I., large or small oval shapes predominated, and upon certain media, types resembling *B. alatus* were also common. Bacillus II.—*Rhizobium limosospongiæ* sp.n.—is a closely allied organism, remarkable for its polymorphism. In addition to the

* Ann. Inst. Pasteur, xxiv. (1910) pp. 543-62.

† Atti Reale Accad. Lincei, xix. (1910) pp. 150-8.

‡ Proc. Linn. Soc. N.S.W., xxxv. (1910) pp. 36-50.

§ Tom. cit., pp. 29-35.

typical oval cell, such varieties as bent rods, exclamation forms (!), and γ -forms were observed. When parasitic upon the sponge, these bacilli obtain their nitrogenous food from spongin.

Streptobacterium fœtidum.*—L. Jacqué and F. Masay give a preliminary account of this organism, recently found associated with certain morbid conditions, affecting man. It has been isolated from sputum in cases of influenza or early tubercle, from cases of pleurisy and tuberculous meningitis, and in pure culture from a periuterine abscess. It grows luxuriantly upon ordinary media, causing rapid liquefaction of gelatin and blood-serum. On agar the growth extends rapidly over the surface of the medium, rapidly covering the whole surface. Thus, if the water of condensation of an agar slope be inoculated with material containing this organism, a pure growth may readily be obtained by taking a sub-culture from the top of the slope after twenty-four hours. Morphologically it is a small cocco-bacillus, showing polar staining. In broth it may grow in chains. It is highly pathogenic to laboratory animals, causing death from septicemia in a few hours. A toxin has been obtained, and animals immunized with it yield a powerful antitoxin.

Red Disease of Silkworm Moth.†—C. Broquet describes this disease, which is very prevalent in the Tan-Chau region of Cochin-China. The causal organism is a chromogenic cocco-bacillus. The breeding of silkworms in these districts is carried out under very unsuitable and primitive conditions, which are responsible for the widespread infections. Preventive measures consist in the destruction of all contaminated broods and thorough disinfection of the surroundings. The ravages of this disease are less serious than those of pébrine.

Microbe of Fowl Diphtheria.‡—T. Bordet and V. Fally describe their methods of cultivating this organism. Scrapings of a piece of false membrane are emulsified in saline, and a thread, steeped in this emulsion, is drawn through the nictitating membrane of a fowl's eye, with a needle. After twenty-four hours, the thread is withdrawn. The primary inflammation of the nictitating membrane is transient, but if infection has occurred, a typical rough greyish swelling appears in a few days. A portion is removed, and shaken well in a few drops of sterile saline solution. Plates of rabbit's blood agar are inoculated with this emulsion, and incubated for two days at 35°. If subcultures be made from a portion of plate where there is no obvious growth, pure cultures are usually obtained. The organisms are very small, and frequently cohere in zoogloea-like masses. They stain well with Giemsa's stain. From cultures several months old, if inoculations be made into the scarified pharynx, the disease may be reproduced.

Recent Researches on Soil Bacteriology.§—H. Fischer gives a short account of some recent investigations carried out by himself and others upon the bacterial flora of soil, and its agricultural bearing. The

* Centralbl. Bakt., 1^{te} Abt. Orig., lv. (1910) pp. 433-4.

† Ann. Inst. Pasteur, xxiv. (1910) pp. 530-42.

‡ Loc. cit.

§ Ber. deutsch. Bot. Gesell., xxviii. (1910) pp. 10-20.

experiments show that symbiosis between certain bacteria and plants requires further investigation before the full scope of its practical applications, purposive inoculations of soils on an agricultural scale, can be realized. Further, the author has experimented with artificial soils in which the proportions of calcium salts, nitrates, phosphates, and other ingredients were varied, and comes to the conclusion that, for agricultural purposes, the chemical composition of the soil is quite as important as the nature of its bacterial flora.

DOBÉWOTSKI, K.—**Des microbes producteurs de phénol.**

Ann. Inst. Pasteur, xxiv. (1910) pp. 595-607.

LAZARUS, E.—**Sur une protéolyse de la bactériidie charbonneuse.**

Tom. cit., pp. 577-94.



MICROSCOPY.

A. Instruments, Accessories, etc.*

(1) Stands.

Useful Microscope Device.†—R. Borrow calls attention to a device (fig. 106) by which a difficulty sometimes experienced with a short



FIG. 106.

* This subdivision contains (1) Stands; (2) Eye-pieces and Objectives; (3) Illuminating and other Apparatus; (4) Photomicrography; (5) Microscopical Optics and Manipulation; (6) Miscellaneous. † Knowledge (1910) p. 284.

microscope-tube and an objective of long focus may be easily overcome. A small stage of vulcanite or some other material, with an aperture of about $1\frac{1}{2}$ -in. diameter, is attached to the top of the substage fitting. By this means an extra 2-in. of space between the objective and the object is secured.

Though the device is worth recalling it is far from new; the last recorded instance being that by Tatham in a paper read at the Quekett in 1895.*

Bacteriological Demonstration Table.†—M. Neisser gives a description of the Mikroskop-Karussel, by means of which microscopic preparations of bacteria may be demonstrated to a seated class. Twelve Microscopes are placed at equal distances from one another, upon an iron table which can revolve round a central axis. Each Microscope is placed at a suitable distance from the edge, and is provided with a separate source of light. A wooden rim, which does not move with the rest of the table, is used as a rest for the elbows of the students. Beside the teacher's seat is a lever by means of which the table may be fixed or released, and a bell, to give signal when the table is about to be moved. The demonstrator places a specimen in focus under the Microscope facing him, releases the table and turns it so that the specimen is suitably placed for examination by his right-hand neighbour, mounts another specimen and moves it on. This continues until each Microscope-stage carries an object, and the whole class is provided. The general idea is simple, but the construction of a satisfactory table requires considerable attention to detail. The chief requirement is stability, but it is also essential that there shall be no jarring in the movement or in the operation of the controlling mechanism.

(3) Illuminating and other Apparatus.

Measuring Inclination of Abbe's Drawing Apparatus.‡—W. Georgi points out that, if the mirror of the large Abbe drawing apparatus be at its normal inclination of 45° to the vertical, only one-half of the microscopic field can be drawn. In order to bring in the whole field, it is necessary to change the inclination of the mirror. If the drawing board be not similarly adjusted, a distorted picture will be obtained. This board should make with the horizontal an angle twice as great as that which the mirror makes with its normal inclination. The author's device to simplify this adjustment is to affix scales to both drawing board and mirror.

Improvements in the Leitz Mirror Condenser.§—W. von Ignatowsky points out that the hollow space in the Leitz condenser (fig. 107) makes it necessary to construct the apparatus out of two pieces of glass cemented together. In the process of manufacture, however, it is not possible to obtain perfect precision in the application of the plane surfaces and the small irregularities therefore detract from perfect efficiency.

* Journ. Quekett Micr. Club, v. (1894-7) p. 206.

† Umschau., xiv. (1910) pp. 112-13.

‡ Zeitschr. wiss. Mikrosk., xxvii. (1910) pp. 94-114.

§ Op. cit., xxvi. (1910) pp. 387-90 (1 pl. and 3 figs.)

Fig. 108 shows a new pattern in which these defects are remedied. It will be readily seen that the surfaces of i. and ii. in contact are spherical, and these when cemented together function satisfactorily as a whole. Pl. XV. fig. 1 shows a photomicrograph of the rays issuing from the condenser. The scale of enlargement is such that the distance between

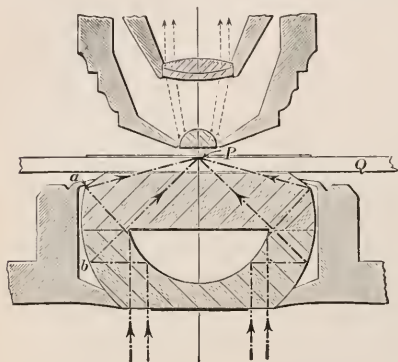

FIG. 107.

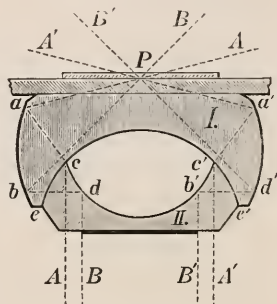

FIG. 108.

the ray-crossing and the lower edge corresponds to the thickness of the object-slide. The photograph was taken by means of a fluorescent uranium glass of corresponding refraction. The uranium glass was placed on the mirror condenser, and by means of a drop of cedar oil

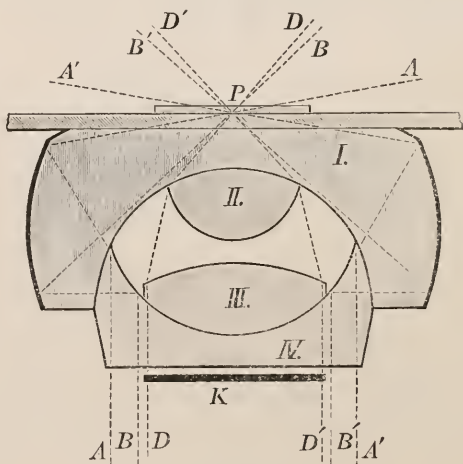

FIG. 109.

optically connected with it. The view of the rays is lateral, and they proceed from a slit, below the condenser, whose length lies in the plane of the paper.

Fig. 109 represents a mirror condenser which may be used for dark-ground or for light-ground illumination. It is somewhat larger than the

1



2

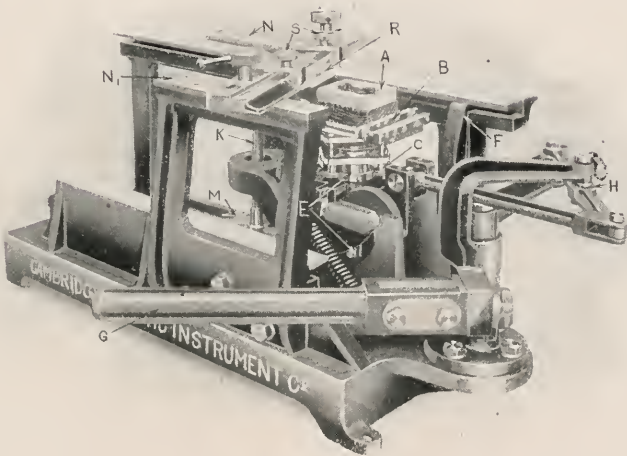

3

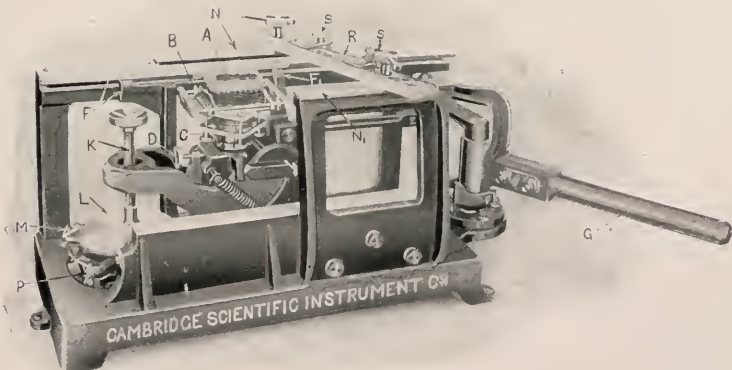

apparatus in fig. 108, and the hollow space contains two lenses cemented to the spherical surfaces as shown. The condenser gives ordinary light-ground effects when K is swung out, and dark-ground when it is replaced.

The author emphasizes H. Siedentopf's observation that apochromatic immersion systems give much better dark-ground results than are obtained with apochromatic dry systems.

Glass and Metallic Replicas of Gratings.*—J. A. Anderson points out that replicas of gratings were first † made by Thorpe in England, and later, by Wallace and by Ives in America. The method used by Wallace and Ives is to pour upon the grating a solution of gun-cotton in amyl acetate, or some similar substance, and after this is dry to allow it to peel off under water, and then to mount it upon a piece of plane glass. One surface of the film of collodion, the one which was in immediate contact with the surface of the grating, is found to be a fairly accurate copy of the ruled surface of the grating itself, while the other one is more or less perfectly flat. The first will be spoken of simply as

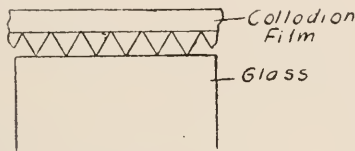

FIG. 110.

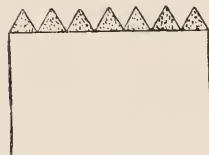

FIG. 111.

the ruled surface, or as the face. Thorpe mounted his replicas with the ruled surface up, while Wallace speaks of mounting the film either ruled surface up or down, preference being given to the latter. It is believed that Ives mounts all of his ruled surface down in contact with the glass. When a replica is mounted face up, it may be transformed into a metallic reflection grating by simply coating it with platinum, by means of cathode disintegration in a vacuum, as has been lately described by E. Gehrke and C. Leithäuser. As a rule, however, this surface is, perhaps, never quite plane owing to the unavoidable differences in the thickness of the film in different places. The author thinks that gratings made in this way will never perform very well when subject to a really severe test. The author, being fortunate enough to have at his disposal a very large number of Rowland gratings, has endeavoured to ascertain "How perfect is it possible to make a replica?"—or, what amounts to the same thing, "How nearly will the resolving power of a replica equal that of the grating from which it was made?" It was found that difficulties arose from the drying of the film, as it had a tendency to shrink. This difficulty increased with the size of the grating. The author found, however, that by mechanically stretching the replica wherever it required it, he was able with practice to correct

* Johns Hopkins Univ. Circular, No. 2 (1910) pp. 19-23 (2 figs.).

† Replicas of gratings in collodion were first made more than half a century ago by the Rev. W. Hodgson.—[Ed. Journ. R.M.S.]

within a small fraction of a fringe, which of course corresponded to the same small fraction of the grating space in the replica itself. A replica corrected in this manner gives the same resolving power as the grating from which it was made within a very few per cent., provided the glass on which it is mounted is optically perfect. In order to transform one of these replicas into a metal grating it is necessary to find a substance which will fill up the grooves (fig. 110) between the replica and the glass surface after the replica has been corrected and dried, and which will adhere to the glass sufficiently to allow the replica to be stripped off. The result will then be similar to fig. 111. This is evidently a fair copy of the grating from which the replica was made. It was accidentally found that certain gums dissolved in the collodion solution will, on gently heating the glass plate upon which the corrected replica is placed, slowly ooze out, filling up the grooves as indicated, and on cooling will harden, and allow the replica to be stripped off. The resulting grating (fig. 111) may now be treated in one of the two following ways:—(1) It may be covered by a thin film of platinum, nickel, or other suitable metal in a vacuum, which coating may be improved by subsequent electroplating, thus producing a durable metallic grating having a perfect optical surface. (2) It may be treated with hydrofluoric acid gas, thus transforming it into a glass or quartz transmission grating with an equally good optical surface, as the gum used is not affected by the acid, while the glass or quartz between the ridges is rapidly attacked. The method is equally applicable to concave gratings. The author has a number of plane platinum, nickel and gold gratings made by the above process, which perform admirably, as well as a number of glass ones made by the hydrofluoric acid process.

Use of the Grating in Interferometry.*—C. Barns points out that, on replacing the symmetrically oblique transparent mirror in Michelson's adjustment by a glass grating, it is possible with ordinary plate glass and a non-silvered grating to produce interferences between pairs of diffracted spectra, if returned by nearly equidistant mirrors to a telescope in the line D. Both of these spectra are very brilliant, and not very unequally so, and the coincidence of spectrum lines, both horizontally and vertically, brings out the phenomenon. This phenomenon is of the ring type, but it occupies the whole field of the spectrum from red to violet. Brilliant large confocal ellipses with horizontal and vertical symmetry are obtained, and the spectrum lines, simultaneously in focus, may serve either as major or minor axes. Their interferometer motion is twofold in character, consisting of radial motion combined with a drift of the figure as a whole in a horizontal direction. Naturally, a fine slit is of advantage, but the experiment succeeds with a wide slit, especially in the red, even after spectrum lines vanish.

Dark-ground Illumination with High Powers.†—R. F. Jones remarks that, "The ability to see living bacteria without the tedious process of preparation and staining, by the use of one of the many dark-ground illuminators that are now obtainable, has to a large extent revived interest

* Amer. Journ. Sci., xxx. (1910) pp. 161-71 (2 figs.).

† Knowledge (1910) p. 284.

in microscopy amongst those who deal with such subjects. It is not generally known, however, that a similar effect can be obtained by the means usually at the disposal of the average microscopist. The author has devised a plan whereby the ordinary Abbe illuminator, if suitably arranged, will do all that is required. There are certain essentials, however, and the first of these is that there must be some centring and focusing arrangements for the condenser. This remark holds good with regard to the new dark-ground illuminators; and, in fact, the necessity is becoming intensively obvious with the advance of microscopical technique. The time will come when every worker will recognize that a centring arrangement to his condenser is of vital importance. The first necessity for the condenser, then, is that a centring arrangement must be provided, for the success or failure of the whole attempt is dependent upon accurate centring. A black-patch stop will be used beneath the condenser lenses, and this again must be properly centred. The best way to ensure this is to have a number of disks cut in metal or black paper and fix them to glass disks cut to the size of the stop-carrier of the condenser. The black patch is moved until it is in the right position, and then allowed to dry. The size of the black patch can be ascertained by experiment. It will vary in each case with the numerical aperture of the objective and the condenser.

The detail in bacteria is not such as calls for a large numerical aperture in the objective, and the high magnification that is necessary to disclose the contour can be used, while the numerical aperture of the objective can be reduced by a diaphragm at the back. This is the rule that should be followed when using the Abbe illuminator as here described. It is necessary to use, as nearly as possible, a spot of light as the source of illumination. An incandescent gas lamp with a diaphragm in front is probably the best. To test the centring of the whole system the aerial image of the dark-patch stop should be focused when the condenser is in position, and as the condenser is moved downwards out of focus the spot should gradually become reduced in size, maintaining its centre if set axially."

GAIDUKOV, N.—*Dunkelfeldbeleuchtung und Ultramikroskopie in der Biologie und in der Medizin.*

Jena: G. Fischer (1910) 84 pp. (3 photos., 2 chromolithogr. pls., and 13 figs. in text.)

GAMBERA, M.—*Fortschritte auf dem Gebiete mikroskopischer Hilfsapparate im Jahre 1909.*

Bamberg: C. C. Buchner's Verlag, 1910 (9 figs.).
See also *Jahrb. Mikrosk. Jahrg.*, i. (1909).

(4 Photomicrography.

Printing on Sensitized Papers.*—H. Wunderer describes his method of using gas-light photographic papers for the reproduction of diagrams. The diagram is put in a frame with the sensitized paper so that the picture is in contact with the prepared surface. The light travels through the glass plate to the back of the diagram paper, then passes through the paper and through the diagram to the sensitive surface of the paper. The average exposure time is about five seconds. In Breuer's process,

* *Zeitschr. wiss. Mikrosk.*, xxvii. (1910) pp. 50-1.

of which this is a modification, the papers are reversed, so that the light travels through the sensitized paper from the back, and is then reflected back from the diagram to the prepared surface. This latter method is only of use when the diagram shows sharp contrasts, but on the other hand it is of use in cases where Wunderer's method is inapplicable, namely, when the diagram paper is very opaque, and when it bears print or other marks upon the reverse side.

Photography with Ultra-violet Light.*—V. Franz makes use of this method for the study of histological details in the ova of fishes. He considers that by this means it is possible to analyse structures which are beyond the limits of investigation by ordinary microscopic methods. The particular investigation quoted in this contribution shows that the chromophile granules in the plasma of these cells really form part of a network.

KÖHLER, A.—**Aufnahmen von Diatomeen mit ultravioletten Licht.**

Jahrb. f. Photogr. u. Reprodukt., 1909.

REICHER, K.—**Mikrokinematographische Aufnahmen bei Dunkelfeldbeleuchtung am Makrokinematographie.** *Berliner klin. Wochenschr.*, xlvii. (1910) pp. 484-6.

(5) Microscopical Optics and Manipulation.

Additional Refractive Indices of Quartz, Vitreous Silica, Calcite and Fluorite.†—At the suggestion of T. Martin Lowry, J. W. Gifford has increased his previous lists‡ of refractive indices for twenty-six wave-lengths by determining those of seven additional ones. These seven rays are of more recent importance, and several of them, especially those in the spectrum of mercury, promise from their extreme brilliance to be of more than usual value. The method of measurement employed and the instruments used were the same as in the previous experiments. The author gives a table of his numerical results, the wave-lengths examined being 6708 Li, 6438 Cd, 5461 Hg, 5086 Cd, 4800 Cd, 4359 Hg, and 4046 Hg.

Measurements of the Absolute Indices of Refraction in Strained Glass.§—L. N. G. Filon has continued his researches on the above subject, and has applied the method which he first described some three years ago.|| The method involves measurement of the deviation of a ray of light passing through a slab of glass under flexure. If a slab or beam of glass of rectangular cross-section be bent in a vertical plane under a bending moment M, and if a plane-wave be transmitted through the glass in a direction perpendicular to the plane of flexure, the light is broken up into two components, one polarized horizontally (i.e. perpendicular to the cross-section and along the line of stress), and the other vertically. The variation in the index of refraction of the

* *Zeitschr. wiss. Mikrosk.* xxvii. (1910) pp. 41-3.

† *Proc. Roy. Soc., A.* lxxxiv. (1910) p. 193.

‡ *Op. cit.*, Feb. 13, 1902, and March 3, 1904.

§ *Op. cit.*, lxxxiii. (1910) pp. 572-9 (4 figs.).

|| *Op. cit.*, lxxix. pp. 440-2.

glass, due to the stress, produces in the vertically polarized ray an upwards deflection, $\theta_1 = \frac{C_1 M t}{I}$ radians, and in the horizontally polarized ray a deflection, $\theta_2 = \frac{C_2 M t}{I}$ radians, where t is the thickness of the glass,

I the second moment of area of the cross-section about the "neutral axis," and C_1 and C_2 are the stress-optical co-efficients for the vertically and horizontally polarized rays respectively; the stress-optical co-efficient for any ray being the increase in the index of refraction for unit tension, or, what is equivalent, the additional retardation introduced per unit thickness per unit tension. In the above, M is reckoned positive when the slab is bent concave downwards. The author gives full details of his apparatus and of his numerical results.

Southall's Principles and Methods of Geometrical Optics.*—In this work of 626 pages, James P. C. Southall has compiled for the English-speaking student a treatise based largely upon the most recent writings of German investigators. He expressly acknowledges his obligations to Czapski's epoch-making book, *Die Theorie der Optischen Instrumente nach Abbe*, and to M. von Rohr's *Die Theorie der Optischen Instrumente*, i. (Berlin, 1904). References to many of the most important contributions to optical literature, French and English, as well as German, of the last fifteen years are freely made. The older writers are also frequently quoted. The author does not hesitate to demonstrate his theorems by the help of modern geometry. Thus in Chapter V. (Reflexion and refraction of paraxial rays at a spherical surface) and Chapter VII. (Geometrical theory of optical images) he makes great use of the properties of harmonic ranges and of conjugate planes. In Chapter XII. he deals with Seidel's extension of Gauss's methods, whereby the inclusion of terms of a higher order in the series-developments made it possible to derive certain elegant and entirely general formulæ in a simple way. These formulæ enable one to perceive almost at a glance how the faults in an image formed by a centred system of spherical refracting surfaces are due partly to the size of the aperture, and partly also to the extent of the field of view. Prism-spectra and the chromatic aberrations of dioptric systems are included under the head of "Colour phenomena" in Chapter XIII.

The work is a very valuable contribution to the study of optics, and should do a great deal to bring an English reader abreast of the latest continental developments.

(6) Miscellaneous.

Method for Testing Screws.†—J. A. Anderson shows how a screw may be tested quite independently of the divided head or end bearings. Consider a screw whose error is a simple periodic one, so that the relation between the distance x advanced by a perfectly fitting nut and the angular rotation θ of the screw is $x = c\theta + b \sin \theta$, where c and b are

* Macmillan Co., Ltd., London and New York, 1910.

† Johns Hopkins Univ. Circular, No. 2 (1910) pp. 14-19 (1 pl.).

constant. If now the screw be rotated with constant angular velocity the velocity of the nut is given by

$$\frac{dx}{dt} = c \frac{d\theta}{dt} + b \cos \theta \frac{d\theta}{dt}$$

or, if k denote the constant

$$\frac{d\theta}{dt}$$

$$\frac{dx}{dt} = ck + bk \cos \theta$$

i.e. the velocity of the nut is a maximum when $\theta = 0, 2\pi, 4\pi$, etc. and a minimum when $\theta = \pi, 3\pi, 5\pi$, etc. Let this nut be cut into two parts by a section perpendicular to its axis, and let one of the two nuts so formed be turned through the angle π , say. If now the two nuts be kept from rotating with reference to each other and the screw be rotated with a constant angular velocity as before, the maximum velocity of one nut will take place at the same time that the other nut has its minimum velocity, and hence the motion of one nut with reference to the other will be a to-and-fro motion given by $D = 2b \sin \theta \div C$, where D is the distance between the two nuts. This is independent of

$$\frac{d\theta}{dt}$$

and hence the screw may be turned by hand and with any angular velocity, and as D is simply the distance from one nut to the other, which is unaffected by any longitudinal displacement of the screw, it is evident that we are entirely independent of errors in end bearings or divided head. All we need to do, therefore, is to measure D , or rather the variation in D , as the screw is rotated, which can be done by mounting one plate of a Fabry and Perot interferometer on one nut and the other on the second nut, and observe the motion of the fringes when the screw is rotated. The method is very sensitive. The maximum shift of one plate of the interferometer with reference to the other is $4b$, and if we measure to $\frac{1}{10}$ of a fringe of green mercury light the smallest measurable value of D will be $\frac{1}{1000000}$ of an inch, i.e. $b = \frac{1}{4000000}$ of an inch, and this ought to be easily measurable. A much smaller error should be easily detected.

The author also discusses Rowlands' method of "cross-ruling." The method consists in ruling a large number of lines and then turning (through a small angle) the plate upon which the ruling was done, and again ruling the same number of lines so as to be able to observe the loci of the intersections of the two sets of lines. If the error is a simple periodic one the locus of intersection will simply be a sine curve. The author gives a photograph showing cross-rulings with different adjustments of the parts of the 15,000 machine.

Micro-chemical Tests for Identification of Varieties of Glass.*

F. Mylius and E. Groschuff give the following scheme for identification of glasses by chemical tests:—

1. Roughly scratch with a file an area on the glass of a few square

* Deutsche Mech. Zeit., v. (1910) pp. 41-5.

millimetres; treat the spot with a drop of ethereal iodeosine solution, and then wash with a drop of ether. A reddish tint shows a basic glass in contra-distinction to quartz glass, which remains colourless.

2. Apply a drop of 10 p.c. fluoric acid on the glass. Immediate opacity shows glass rich in earthy or heavy oxides (calcium, barium, lead, zinc, etc.); glasses poor in metal give no opacity.

3. Moisten the end of a platinum wire with the reaction product of No. 2, and carefully bring it into the Bunsen flame. A transient green illumination shows boric acid with certainty; yellow shows sodium. Fairly large quantities of potassium are at the same time recognized by the violet tint transmitted through a cobalt-blue glass held in front of the eye, but better by the characteristic line in the red of a pocket spectroscope.

4. Apply a drop of dilute sulphuric acid to the reaction product of No. 2. A black coloration shows lead (flint-glass), in contrast with leadless glasses which remain colourless. Antimony gives the well-known orange precipitate.

Further investigation on the metallic constituents of glass is performed in vessels. For this purpose reaction No. 2 is repeated, but five minutes are allowed for development. The reaction product is rinsed with 3 c.cm. of water in a porcelain or platinum crucible, and mixed with just so much (about 0.1 gram.) sodium-bicarbonate that after the effervescence a small residue is left. This is heated for about two minutes, until it coagulates. The completeness of the process is attained when a drop of the alkaline fluid does not decompose methyl-blue solution; should this happen, the heating is to be continued. After the heating, decant, wash the precipitate 3 times with 3-5 c.cm. water, and having treated it in the crucible with 10 drops of dilute hydrochloric acid, reduce it in a steam oven at 100° C. to dryness. The small residue is treated with 3 c.cm. of water, to which 2 drops of dilute hydrochloric acid have been added. The undissolved portion is the silicic acid of the glass, and this must be filtered off. The filtrate is a chloride solution: it must be freed, if necessary, by sulphuric acid from lead (or antimony) in order to be available for further investigations.

5. Place the solution in a test-tube, acidify with a drop of dilute sulphuric acid, and boil up. A heavy white solution is barium.

6. Treat the solution, filtered if necessary, from No. 5 with a drop of potassium ferrocyanide solution. A white slimy precipitate is zinc; if the precipitate is bluish, there is a trace of iron.

7. Treat the solution (filtered if necessary) from No. 6 with 3 drops of ammonia solution, and heat to boiling. A white flocculent precipitate gives aluminium.

8. Treat the solution (filtered if necessary) from No. 7 with 1 drop of dilute oxalic acid, and warm slowly. A white opacity after 2 minutes shows calcium.

9. Treat the solution (filtered if necessary) from No. 8 with 2 drops of sodium phosphate solution. A slowly formed granular precipitate shows magnesium.

The author has, in another article,* studied the decomposability of

* Deutsche Mech. Zeit. (1908) p. 1.

glass under the influence of moist air. He has found this to be easily measurable, and the following table is a classification (by metals, not by oxides) of some important varieties.

Applicability for	Chemical Class	Description	Relative Decomposability
Thermometers ; chemical purposes	Sodium-aluminium- boro-silicate	Jena, No. 59iii	3
Optical crown- glass	Ditto	Jena, No. 3917	3
Ditto	Potassium-barium- zinc-boro-silica	Jena, No. 4556	5
Optical flint-glass	Potassium-sodium- lead silicate	Jena, No. 4113	5
Ditto	Potassium-barium- zinc-lead-silicate	Jena, No. 4531	5
Chemical purposes	Sodium-calcium- zinc-boro-silicate	Stutzerbach "Resistance-glass"	8
Plate-glass	Sodium-calcium- silicate	"Rheinish mirror- glass."	20
Optical glass	Sodium-barium-zinc- boro-silicate	Refractive Index $n = 1.518$	60
Ditto	Sodium-aluminium boro-silicate	$n = 1.464$	600
Ditto	Ditto	$n = 1.461$	1800

Ultramicroscopic Examination of Colours of Textile Fibres.*—
J. Schneider and J. Sourek, in continuing the investigations of Schneiden and Kunzl upon the above subject, endeavoured to approach their task from two points of view. 1. From the theoretical standpoint—with the object of discovering whether distinctive appearances could not be found with regard to regular pigment deposits in the case of direct colouring of cocoon silk. 2. From the practical standpoint—with the object of establishing the applicability and trustworthiness of the ultramicroscope in the testing of textile fibre pigments, with the hope of giving a very simple introduction to this testing.

In the case of the first it was hoped that by the use of polarized light distinctive rotations of the plane of polarization might be definitely connected with certain conditions of silk-coloration. The results were, however, unsatisfactory.

In the case of the second point of view, uniformly broad strands of silk from the middle part of the cocoon could be usefully examined. If these furnished only small portions of an absorption spectrum it was found that the colours in the two crossed-nicol positions were complementary. Thus this method of examination might be useful when

* Zeitschr. wiss. Mikr., xxvii. (1910) pp. 219-26.

other methods failed or were, for any reason, not available. The method is, however, complicated by the necessity of paying attention to colour-intensity, fibre-thickness, and orientation. Even in comparison with samples these considerations must be observed. The authors give a long list of their results, their colour-names being made to correspond with those used in G. Schultz' "Tabellarischen Übersicht der im Handel befindlichen Künstlichen organischen Farbstoffe" (Berlin, 1902).

Examination in Microscopy.*—Examination questions upon almost every subject are now in vogue; then why not upon Microscopy? Here are two with which to begin:—

1. With a Ross 4 in. (actually a $2\frac{3}{4}$ of $\cdot 085$ N.A.) resolve Grayson's 10,000 band, using artificial light from a paraffin lamp with a $\frac{1}{2}$ in. wick.
2. With the same illumination and a Zeiss *au*, resolve Grayson's 20,000 band.

A light-filter may be used in answering both these questions, and the time allowed for this paper is one week.

Resolutions with low powers sound charmingly simple; but these two resolutions will not be accomplished by anyone who is not well up in microscopy. Those who do not wish to go in for the paper may do worse than occupy some of the coming winter evenings in trying to solve these questions, for facility in microscopical manipulation, as in everything else, can only be acquired by practice.—E. M. NELSON.

Quekett Microscopical Club.—The 468th Ordinary Meeting was held on October 25, at 20 Hanover Square, W., the President, Professor E. A. Minchin, M.A. F.Z.S., in the chair. A paper on "Some New African Species of *Volvox*," by Professor G. S. West, M.A., D.Sc., F.L.S., was read by Mr. C. F. Rousselet, F.R.M.S. The first of the new species, *Volvox Rousseleti* sp. n., was collected by Mr. C. F. Rousselet from a pool near Gwaai station in Rhodesia in 1905. The diagnostic features of this new species are, the enormous number of the cells, from about 25,000 to more than 50,000, constituting the colony, and the density of their arrangement. *V. africanus* sp. n. was obtained by Mr. R. T. Leiper from the Albert Nyanza in 1907. The form is close to *V. aureus*, but differs in the form of the vegetative (asexual) colonies, in the great development and compression of the daughter-colonies before they are set free, and in the fact that three, and often four, generations of colonies always appear to be well marked. A paper on "Two New Species of *Cassidulina*," contributed by Mr. H. Sidebottom, was read by Mr. A. Earland. These are *Cassidulina elegans* sp. n. and *C. decorata* sp. n. Both forms were obtained from H.M.S. 'Waterwitch,' South-west Pacific, station 159, and the second form also at station 256. Mr. C. D. Soar, F.R.M.S., read "A Contribution to the List of Hydrachnida found in the East African Lakes." The contents of three tubes had been examined. These had been collected from Victoria Nyanza, Tanganyika, and Nyassa respectively. From the Victoria Nyanza tube only one species was identified, *Unionicula figuralis* Koch. From Lake Tanganyika six forms were

* English Mechanic, xcii, (1910) p. 297.

noted, of which three are new to science: these are *Neumannia papillosa* sp. n., *Mideopsis minuta* sp. n., and *Hygrobates edentipalpis* sp. n. The Lake Nyassa tube only yielded one species, but this is another new one, *Unionicula Cunninghami* sp. n., very close to *U. figuralis*. The paper includes a list of the seventeen species of Hydrachnids now recorded from the East African lakes. All the new species referred to at this meeting are fully described and figured in the November issue of the Journal of the Quekett Microscopical Club. Mr. A. C. Banfield exhibited living specimens of *Cristatella mucedo* abnormally hatched from statoblasts. The usual time of appearance is about the end of February and beginning of March.

Katalog der Kollektivausstellung der deutschen Präzisionsmechanik und Optik auf der Weltausstellung in Brüssel, 1910.

Deutsche Mechan.-Zeitg., 1910, Heft 12, p. 117.

B. Technique.*

(1) Collecting Objects, including Culture Processes.

'Michael Sars' North Atlantic Deep-sea Expedition, 1910.†—Johan Hjort gives an interesting description of the voyage of the 'Michael Sars,' lent by the Norwegian Government, the expenses of the expedition being defrayed by Sir John Murray. The expedition left Bergen at the end of March 1910, picked up Murray at Plymouth, and then followed the coasts of Europe and Africa down to Cape Bogador, carrying out special investigations in the Bay of Biscay, Bay of Cadiz, and the waters between the Canary Islands and Africa. It then proceeded to the Sargasso sea, and after touching at the Azores it went across the Atlantic to St. John's, Newfoundland. From there it crossed to Ireland, and finally investigated the waters between Scotland and Rockall, and between Scotland and the Faroes, so as to study the influence exerted by the Atlantic Ocean on the Norwegian sea.

Only a sketch of the doings is given, but the preliminary description is full of facts and interest. After alluding to the results of the hydrographical investigations the writer describes the methods of obtaining phytoplankton. Vertical hauls were made at various depths with a fine-meshed Nansen closing-net, the object being to collect material for studying the vertical and horizontal distribution of peridinæ and diatoms in the Atlantic Ocean. A considerable part of the work was directed towards the study of those organisms which pass through the finest silk net; these were collected partly by filtering sea-water through sand filters, and partly by centrifuging. In these ways a large number of new forms were obtained.

For catching zooplankton a vertical closing-net, 1 m. in diameter, made of coarse silk, was used. For reasons given, this was superseded by large nets of 3·25 m. in diameter, made partly of coarser silk and partly of prawn-net, arranged on the principle of Nansen's closing-net.

* This subdivision contains (1) Collecting Objects, including Culture Processes; (2) Preparing Objects; (3) Cutting, including Imbedding and Microtomes; (4) Staining and Injecting; (5) Mounting, including slides, preservative fluids, etc.; (6) Miscellaneous.

† Nature, lxxxv. (1910) pp. 52-5 (5 figs.).

Though fairly successful, several difficulties arose, but these were surmounted. The chief object was to obtain simultaneous hauls at various depths, and it was found difficult to prevent the long wire-rope from twisting. The difficulty was solved by an arrangement by which a shackle, to which the appliance is fastened, moves freely round the wire. By this means it became possible to have no fewer than ten appliances out simultaneously from two wires.

The material obtained was very large, and quite a number of pelagic deep-sea fish not previously described was discovered. A large trawl was also used; this made twenty hauls. The results were successful, but do not appear to include any new discoveries.

Studying the Relation between Light and Pigment Formation in *Crenilabrus* and *Hippolyte*.*—The vessels used by F. W. Gamble consisted of large bell-jars, supplied with an air or water current, or stirred by a glass plunger. Seasoned vessels, as well as sterilized ones, were used; filtered "outside" and tank-water were respectively employed; diatoms and algæ were used as food. The vessels were shaded, exposed to diffuse light, and kept in darkness; the backgrounds were translucent, absorbing and reflecting; the incident light used was monochromatic (red and green) as well as white light. The temperature was kept down to 16° C. by a water-jacket, and in other cases allowed to rise to 18° C. or over, but in spite of all these variations the larvæ survived only about ten days. The monochromatic screens used in the case of larvæ consisted of selected pieces of coloured glass (ruby or green) combined with coloured gelatin films. These were placed over the inverted belljars, the sides of which were converted into absorbing or reflecting backgrounds. A continuous air-current was led into the water, and the covered screen was cut so that its halves embraced the air tube, which was blackened at this point. The junctions of the screen with the bell-jars consisted of black velveteen, so as to cut out any oblique white rays, but it was found that great care is needed to avoid liquefaction of the gelatin films. In order to observe the prolonged effect of monochromatic light, and to obviate the dominant influence of the background, fluid screens were constructed. To insure a fairly strong light, the screen was made of one cell only. A double glass vessel, consisting of two beakers, or of two large cuvettes, the inner one standing on glass supports, so that its rim just cleared that of the outer vessel, was employed. The inner vessel was then provided with young transparent *Hippolyte* in filtered water, and finely divided Ceramium was used as food. The space between the two was then filled with the colour filter, until the level exceeded that of the water in the inner vessel, the top inch or so of which was rendered opaque. A cover of glass, or of glass and gelatin, was placed over the double vessel, and the whole was then transferred to a shallow aquarium in a strong light. In one case a circulation of tank water was maintained in the inner vessel. The main point of the apparatus is to provide a means of flooding the animals with transmitted coloured light, and thus largely to avoid the effect of light reflected from an absorbent or deflecting back-

* Quart. Journ. Micr. Sci., lv. (1910) pp. 553-5.

ground. The surfaces on which the vessels stood were either slate or dull white brick, but there was always a layer of the fluid some 2 cm. thick between the bottoms as well as between the sides of the two vessels. The coloured solutions employed consisted of the following: for red, a strong solution of erythrosin in distilled water, the strength being increased until a 2 cm. layer cuts out all the orange. Weak lithium carmine solution in a 2 mm. layer was also used. For green, a 60 p.c. solution of copper chloride with a trace ($\frac{1}{20}$ vol. used) of 6 p.c. potassium chromate gave a good result in 1.5 and 2 cm. thickness. For blue, ammoniacal solution of copper sulphate was used, a strong ammonia being added to a concentrated solution until the precipitate thrown down could be filtered off; this screen, owing to the ammonia fumes, is very toxic. The light employed was direct, or direct and diffuse, daylight. In the former case the vessels stood for more than half their depth in a tank placed on the south side of Plymouth laboratory.

Studying the Development of *Aplysia punctata*.*—A. M. C. Saunders and Margaret Poole obtained *Aplysia punctata* in large numbers until the middle of June. There was no difficulty in keeping them in the aquarium, and they laid eggs in great quantities. Early in the summer the eggs were attacked at times by bacteria, and later in the year by algæ. The rate of development was found to vary with the temperature of the water. In April, about fifteen days elapsed between the deposition of the eggs and the emergence of the free-swimming larvæ. The authors failed to rear the larvæ beyond the free-swimming stage.

Cultivation of Meningococci.†—The examination of fluid from a lumbar puncture for meningococci is a simple process when the organisms are numerous, but in many cases, when they are scarce, the ordinary methods of cultivation upon ascitic or hydrocele agar give negative results. R. Bruynoghe recommends instead the use of the spinal fluid itself. This is added in definite quantities to broth-tubes, and after a few hours incubation a definite pellicle makes its appearance, consisting of meningococci in pure culture. In cases of mixed infection or contamination this method will not be successful. If the fluid be very purulent the fluid is allowed to settle, and the upper clearer fluid is inoculated as above into broth-tubes. Comparative investigations show that this method gives much better results than that which involves the use of ascitic agar.

(2) Preparing Objects.

Automatic Fixing and Imbedding Apparatus.‡ — G. Arndt describes a machine (figs. 112–114), the use of which would save a considerable amount of tiresome manipulation in pathological laboratories. It receives portions of fresh tissue, and after due time returns them imbedded in paraffin, ready for cutting. The apparatus consists of three principal parts, a thermostat, a cover *e* carrying a metal cage *ko* and a clock, which controls the automatic mechanism by means of electrical contacts. The inner casing of the thermostat carries a circular series of

* Quart. Journ. Micr. Sci., lv. (1910) pp. 498–9.

† Centralbl. Bakt., 1^{te} Abt. Orig., lvi. (1910) pp. 92–4.

‡ Muench. Med. Wochenschr., lvi. (1909) pp. 2226–7.

eight copper vessels, containing, say, formalin, rising alcohols, clearing fluid, and paraffin. The material to be prepared is placed in the cage *ko*, and the cover *e* is lowered (as in fig. 112) so that the cage and its contents are immersed in the formalin bath. The contact makers around the margin of the clock are set so as to control the length of stay in each

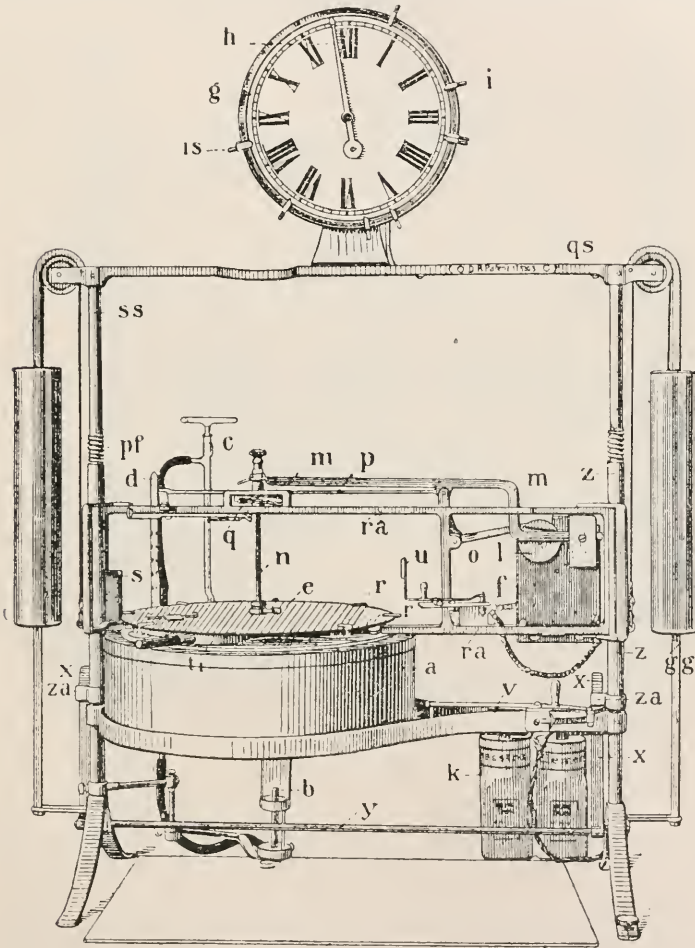

FIG. 112.

bath. When the hand reaches the first stop, a contact is made; this sets in motion a mechanism which raises the carrier and turns it through one-eighth of a circle so that the cage comes to rest above the next bath. This position is shown in fig. 113. After a moment the contact is again broken and the cover again descends. Thus each time the clock-hand reaches a stop, the tissue is transferred to the next bath,

until finally it reaches the paraffin. When the last stop *is* is reached, a special contact is made, which causes the clutches $x_1 x_1$ to be released. The counterpoises *gg* then descend along their guides, and the whole inner casing, with its ring of copper vessels, is raised out of the thermostat. This position is shown in fig. 114. In this position the paraffin cools and solidifies. The block is now ready for the microtome.

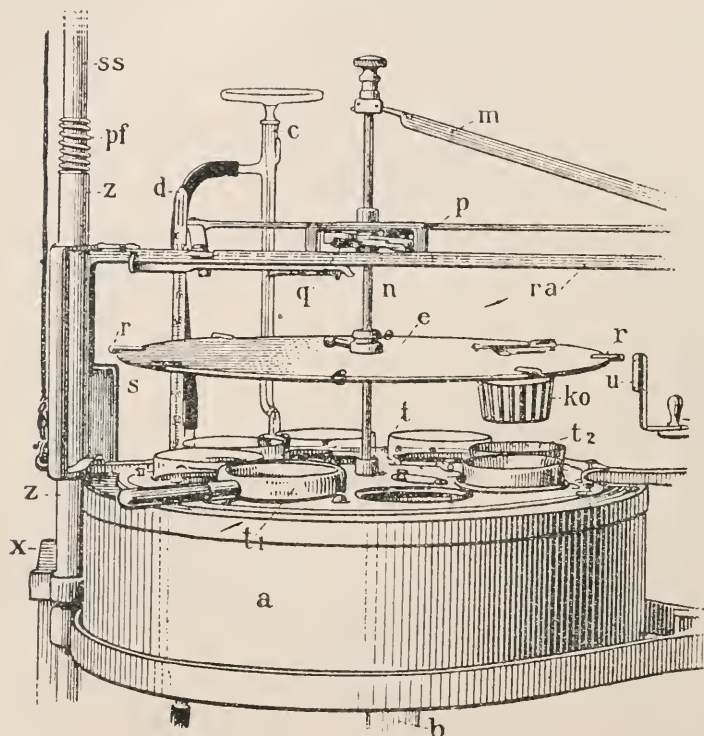

FIG. 113.

Preparation and Staining of Neuroglia.*—H. von Fieandt employs the following method. Small portions of tissue, not larger than 2 c.mm., are taken from the fresh brain and fixed in Heidenhain's sublimate trichloroacetic fluid for 24 hours. They are then treated in 96 p.c. alcohol for a week, and in absolute alcohol for two days, the alcohols being changed twice a day. The material is now placed in cedar-wood oil for 24 hours, and then, after a further 24 hours in ligroin, is transferred to a ligroin-paraffin mixture, and finally imbedded in paraffin (melting-point 52°C.). After cutting, the sections are fixed to the slide by the Japanese method, freed from paraffin, washed in alcohol, and then treated for an hour with alcoholic iodine. The preparations are then freed from iodine with sodium thiosulphate, washed in distilled water and stained

* Arch. Mikr. Anat. u. Ent., lxxvi. (1910) pp. 137-41.

with Mallory's hæmatoxylin phospho-tungstic acid solution for 12 to 24 hours. Then, after treatment for an hour with alcoholic ferric chloride, the slide is washed with distilled water, and soaked in absolute alcohol in order to remove the last traces of iron. The differentiating effects of ferric chloride can be controlled by microscopic examination, the reagent

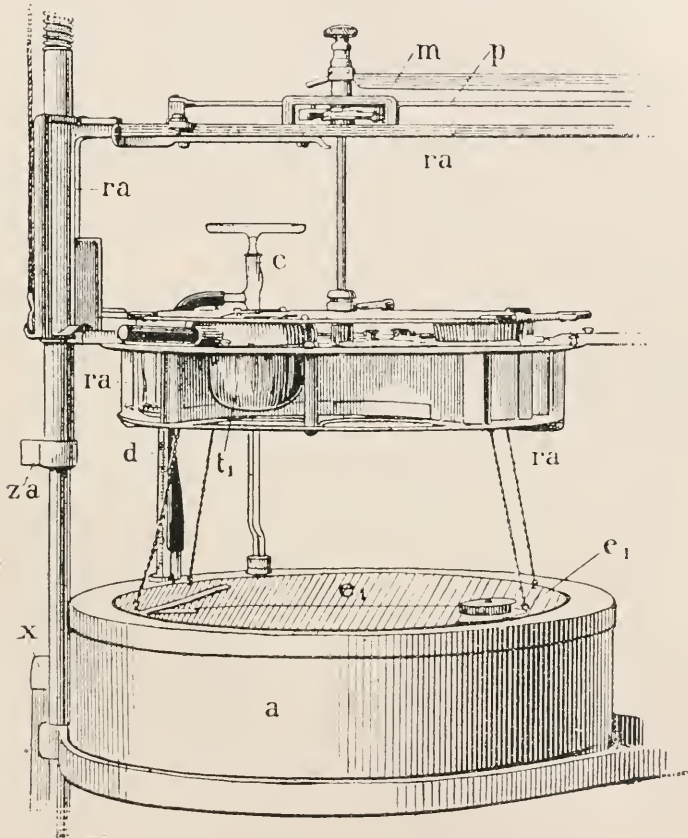

FIG. 114.

being washed off when the process has gone far enough. After 24 hours in absolute alcohol, the sections may be cleared and mounted. The glia fibres are stained deep blue, axis cylinders greyish yellow, elastin yellowish brown, glia protoplasm light blue, and erythrocytes a dirty yellowish grey.

(3) Cutting, including Imbedding and Microtomes.

Theory and Practice of Sharpening Razors.*—C. Fnnck considers in some detail the conditions of razor edges, their imperfections and the

* Zeitschr. Wiss. Mikrosk., xxvii. (1910) pp. 75-91.

methods of sharpening them. Under the first heading he describes the bevels and the effects of notches and striae upon the sections cut. The fluting and opacity of the free portion of paraffin sections illustrates the effect of these striae; with a perfect edge the paraffin should cut quite clear. Under the second heading he considers the materials used for sharpening razors, and emphasizes the necessity of using fine impalpable powders of uniformly sized grains. The uniformity of these grains is secured by making timed suspensions in water. He recommends the use of alumina. Finally, he describes apparatus in which the manual labour is replaced by water-driven or electrically-driven sharpening machines.

Large Sliding Microtome.*—The Cambridge Scientific Instrument Company has recently designed a large microtome (Pl. XV. figs. 2, 3) for cutting flat sections up to 150×120 mm. ($6'' \times 4\frac{3}{4}''$). It is capable of cutting through decalcified bone or cartilage, and is being found extremely useful for cutting sections which are too large to be cut with either of the makers' two rocking microtomes.

The object, embedded in a block A of paraffin wax or celloidin, is fixed to the wood block which is clamped in the object-holder B. This object-holder is fitted with orientating adjustments very similar to those used in the makers' rocking microtomes; being mounted in a cup-shaped socket at the end of a brass pillar E. This pillar can be raised or lowered and clamped at any height by the clamping screw D. The orientating adjustments are made by four screws, one of which is lettered C.

The sliding carriage, which supports the object-holder and feeding mechanism, rests at three points on two guides in the frame of the instrument. The whole carriage can be moved backwards and forwards on these guides by means of the handle G, working through the levers H. The design is such that all wear is automatically compensated for. After the cutting stroke, and when the carriage has nearly reached the extreme position as in fig. 1, a stop-pin, operating through the ratchet M, turns the toothed wheel L and screw K, so feeding the object-holder upwards. The amount of the feed is regulated and indicated by the index P. On the return stroke the mechanism causes that part of the sliding carriage which holds the object-holder to drop just before it reaches the knife R, in order to avoid fouling the same, and to rise after passing the knife to its former position in preparation for the next cutting stroke.

The construction of the sliding carriage is such as to convert the feed into a parallel motion, and so give sections of a uniform thickness; and, further, since the carriage slides on plane guides, the sections are also from a plane surface. The knife R is clamped in two heavy brass clamps by the screws SS. The position of these clamps can be moved so as to set the knife obliquely to the direction of movement of the object. The clamping screws TT hold the clamps firmly in position. The angle the cutting edge makes with the horizontal plane is also readily adjustable, and a small angular scale is divided on the knife-holders so that the same angle can be easily repeated.

Two knives, each measuring 30 cm. long by 5 cm. wide, are supplied. The first one "A" is ground to a very fine angle, and is used for delicate

* Cambridge Scientific Instrument Co., List No. 57A (1910) pp. 8-10 (3 figs.).

work, as, for instance, with soft celloidin, fresh, or alcohol-hardened preparations. The second knife "B" is the most generally useful knife. It is not ground to such a fine angle, and is used with the majority of paraffin preparations and also with hard celloidin.

The microtome will cut sections measuring up to 150×120 mm. ($6'' \times 4\frac{3}{4}''$) in either paraffin or celloidin. The thickness of the sections can be varied from 0 to 0.06 mm., each division on the scale being equal to 0.002 mm. The total distance through which the microtome will automatically feed the object-holder is 21 mm.

Pl. XV. fig. 2 shows the instrument with the knife in position for cutting celloidin section. In fig. 3 the knife is seen in position for cutting paraffin.

An Eighteenth Century Microtome.*—Description of an instrument for cutting transverse slices of wood for microscopical objects.

A A, in No. 1 (fig. 115 †), represents a cylinder of ivory, $3\frac{1}{2}$ -in. long and 2-in. in diameter, to the one end of which is fitted B B, a plate of bell-metal, the section of which with the manner of fitting it to the ivory, may be seen in 2, in which the several parts are marked with the same letters as in 1.

C is a plate of brass, fitted to the other end of the cylinder, through which and the ivory there pass two long screws, which take into the thick part of the bell-metal B B, so as to fix both plates strongly to the ivory, into which they are also indented, so as to prevent such shaking as might otherwise happen after swelling or shrinking.

D D. The cutter, whose edge is a spiral, and the difference of whose longest and shortest radii is equal to the thickness of the largest piece of wood that the instrument would take in. The lowest side of this cutter must be ground extremely flat and true, in order that all the parts of its edge may be exactly in the same plane, and that the middle part of it may be applied closely to the flat circular plane left at the centre of the plate B B, to preserve it in the proper direction when carried round by the handle.

All that part of the bell-metal which the edge of the cutter traverses is turned so low as not to touch it (see the section), the middle of the cutter is about $\frac{1}{5}$ -in. thick and has in it a square hole that fits on the end of a steel axis P P, one end of which turns on a pivot in the plate C, the other end in the plate B B. This end has a conical shoulder which fits into a hole of the same shape in the under side of the plate, as represented in the section.

ee. A piece of brass somewhat in the form of an index, which is also put on the axis P P; this piece has a round hole in its centre, so large as to admit of its being turned into any position with regard to the cutter; and in order to keep it concentric thereto there is left on it a circular projection, which fits into a cavity made in the lower side of the handle where it fits on the axis (see the section).

* The Construction of Timber from its early Growth; explained by the Microscope and proved from Experiments, in a great variety of kinds. By John Hill, M.D., Member of the Imperial Academy. London, 1774, 2nd ed., 64 pp. folio (44 pls.).

† The block for this illustration was kindly presented by Mr. C. Lees Curties.

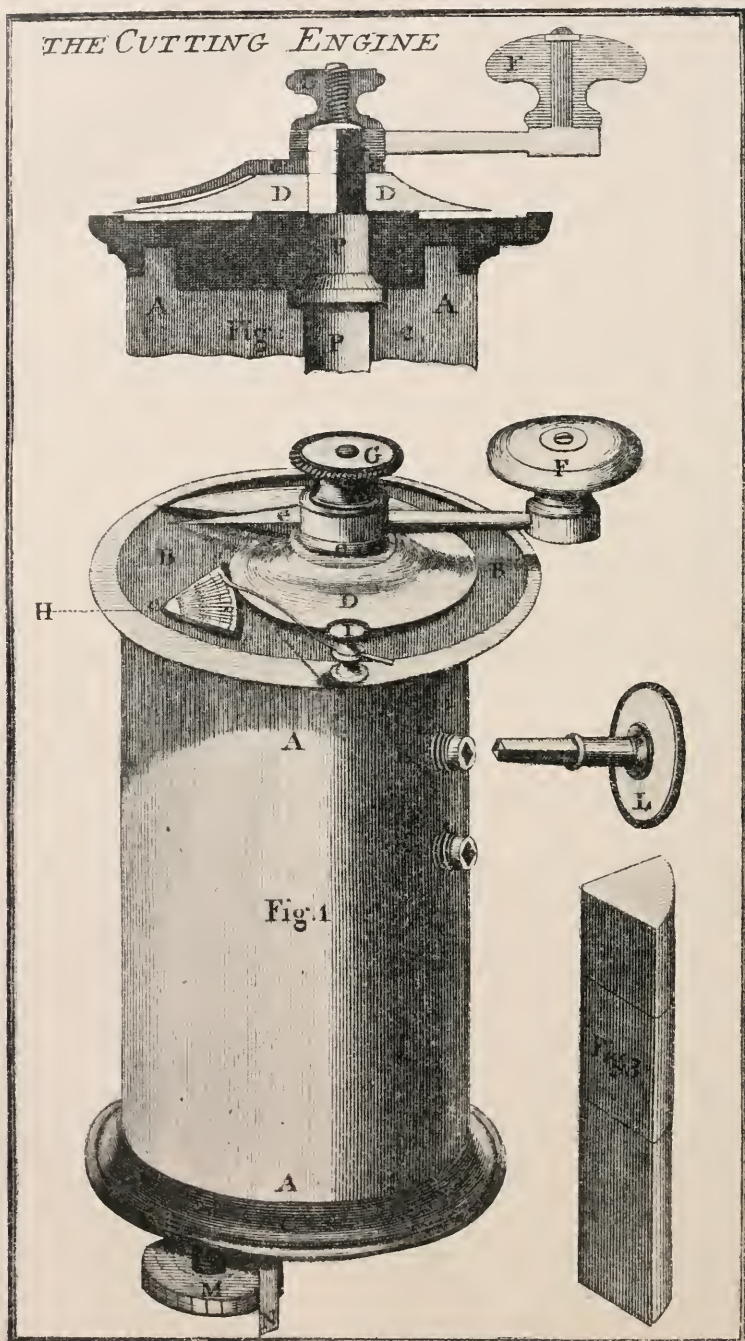

FIG. 115.

F. The handle, which is so fitted on the axis P P that it carries the cutter and the piece *ee* round with it.

G. A nut that screws the handle on its axis and keeps the cutter flat to the bell-metal B B when carried round by the handle.

ooo is a hole, nearly in shape of the sector of circle, pierced through that part of the bell-metal which the edge of the cutter traverses, and continued through the whole length of the cylinder, truly parallel to its axis and of an exact equal width throughout, till it terminates in the plate C.

H represents the end of a piece of wood of which slices are to be cut, and which is put into the cavity *ooo*, into the angular part of which it is gently pressed by means of K K, two brass screws, which pass through the ivory into the cavity *ooo*, and are made to press on the wood *h* by means of L, a key that fits into hollow squares made in the screws K K.

M. A screw that passes through the brass plate C, opposite the middle of the cavity *ooo*, and by means of which the wood *h* is raised to the cutter. This screw has forty threads to an inch, and its head, being divided into twenty-five equal spaces, it is evident that the moving one of these divisions or spaces will make the screw advance, and raise the wood *h* just $\frac{1}{1000}$ of an inch.

N. An index that points the divisions on the head of the screw M. The breadth of this index, from the one fiducial edge to the other, subtends a division and a half on the head of the screw, by which means half divisions as well as whole ones may be accurately shifted; and the $\frac{1}{2000}$, $\frac{1}{1500}$, $\frac{1}{1000}$, $\frac{1}{750}$, etc., parts of an inch, truly estimated. To render the effect of this screw the more certain, its point is turned round so as to act very near the centre, and a piece of ivory (see 3) is carefully fitted into the cavity *ooo* so as to move freely therein without any lateral shake, and to rest on the end of the screw M. This piece of ivory acting equally on every part of the under surface of the wood, will raise it towards the cutter with much more certainty than if the screw acted immediately on it. Several such pieces of ivory, of different lengths (as represented by 3), ought to be fitted to the instrument, so as readily to suit the length of any given piece of wood. One piece, of the full length of 3, must have one end left rough from the file, that pieces of cork, agaric, the pith of wood, and such other soft substances, may be cemented on it with sealing wax, in which case they can be cut into slices of a determinate thickness, as well as wood.

Now if a piece of wood, whether round or of the shape represented in the instrument at *h*, and of whatever size, be put into the cavity *ooo*, and gently pressed into the angular part thereof by the screws K K, let it be raised towards the cutter by means of the screw M. If the handle be turned to the right, the edge of the cutter will advance on the wood, and cut off such part as lies above the plane in which the edge of the cutter moves, and when the upper surface of the wood is thus rendered flat, slices may be cut of any required thickness, according to the number of divisions that the screw M is made to advance. If the machine be made with due care, it will readily cut a thousand slices in an inch, and if the edge be good and very well set, slices may be cut

that are no thicker than the $\frac{1}{1500}$ or even the $\frac{1}{2000}$ part of an inch; but this requires management, much depending on the force with which the screws K K pinch the wood.

It is not an easy matter to procure an edge sufficiently fine for the above purpose, but, with the very best possible, thin slices have a tendency to curl up into rolls, so as to be unfit for the Microscope: to prevent which a very slender spring is made to press gently on that extremity of the slice where the incision begins, so as to keep it flat to the cutter; when this spring is set to its proper position, it is fixed to it by the small finger-screw I. And, lest the action of this spring should destroy the slice after it is wholly cut, and in passing over the extremity of the cutter, the piece *ee* (which turns with the cutter) is fixed by the nut G into such a position that in passing under the spring it raises it, and relieves the slice at the very instant that the cutter has wholly done its office; and thus the slices are made to fall into spirits of wine, in which they are preserved for use.

In some woods the pith shrinks so very fast, that it is extremely difficult to keep it entire in slices that are thinner than $\frac{1}{750}$ of an inch; to remove which imperfection an instrument of the nature above described was made to shift its own screw at every revolution of the handle, so that very little time was left to the pith to shrink, as a hundred slices could easily be cut in a minute, and the pith was as entire as the wood. This instrument had an index which, being set to the numbers 500, 750, 1000, made it cut so many slices to an inch. It performed extremely well, but was judged less fit for general use than that which has already been described, it being more complex and liable to disorder, as well as more difficult to manage.

The cutting engine is an invention of the ingenious Mr. Cummings. The two or three first were perfected under his own hand, and they are now made for general use by Mr. Ramsden.

Numbering Celloidin Sections.*—A. Yurisch gives an account of his experiences with Suzuki's method of numbering serial celloidin sections. This consists, briefly, in numbering the sections in order as they are cut, by marking with Indian ink, so that although mixed during subsequent manipulations, they may be mounted in the correct order. The author finds that such Indian ink marks resist most of the ordinary stains and reagents, and are still legible after sections have been kept for several months. If the numbers are made too large the excess of pigment may be deposited over the surface of the section in small black indelible granules. On the whole, the method is to be commended for its rapidity, simplicity, certainty, and cheapness.

FISCHER, OTTO—Über Ferienkwise für Wissenschaftliche Mikroskopie.

Zeitschr. wiss. Mikrosk., xxvii. (1910) pp. 94-114.

(4) Staining and Injecting.

Detection of Tubercle Bacilli in Milk and Fæces.†—E. H. R. Harries recommends the following method. The smear is first stained

* *Zeitschr. wiss. Mikrosk.*, xxvii. (1910) pp. 63-6.

† *British Med. Journ.* (1910) ii. p. 1295.

with carbol-fuchsin for 15 to 20 minutes in the cold, and then the superfluous fluid is drained off. Pappenheim's stain is then applied until the preparation is blue; the slide is then washed, dried, and mounted in balsam. Pappenheim's stain consists of 1 p.c. rosolic acid in absolute alcohol, to which is added methylen-blue to saturation and a small quantity of glycerin. The smears from fæces should be thin; milk should be centrifuged, and the fat removed by means of ether.

Staining Blood Platelets.*—J. Homer Wright demonstrated the histogenesis of the blood platelets by the following procedure. The material should be obtained immediately after death or taken from the living animal. For fixation methyl-alcohol, formaldehyde, or a saturated solution of mercuric chloride in a 0.9 p.c. solution of sodium chloride, may be used. Methyl-alcohol is not now recommended for fixation. Formaldehyde should not be allowed to act longer than 48 hours. The method is not applicable to material fixed in Zenker's fluid. The tissue is dehydrated by alcohol followed by acetone, cleared in thick oil of cedar followed by xylol, and imbedded in paraffin. The sections should not be more than 4μ in thickness. Crystals of corrosive sublimate in the sections are to be removed by treatment with Gram's solution of iodine and alcohol. The sections are stained while affixed to the slide by Meyer's glycerin-albumin mixture. The staining fluid and the mode of its preparation are described below.

The staining, clearing and mounting is carried out as follows:—

1. Equal parts of the staining fluid and distilled water are mixed in a small wine glass and immediately poured on to the slide. The measuring is conveniently done by means of a small pipette provided with a rubber bulb. At least 2 c.cm. of the freshly diluted staining fluid are thus spread out over the slide, which should be supported upon some object in such a way as to prevent the fluid from running off. The spreading out of the fluid in a layer is important, because it facilitates the evaporation of the alcohol whereby the staining elements slowly precipitate out of solution and, while doing so, stain the tissue elements. This precipitate appears as a yellowish metallic scum which slowly forms on the surface of the mixture. The diluted staining fluid is allowed to act for about 10 minutes, when the preparation is immediately washed in water. The exact time required for the best results has to be determined for each batch of the staining fluid. The proper staining of the preparation may be judged by examining it by a yellowish artificial light under a low magnifying power, after pouring back the diluted staining fluid into the wine glass. The stain is to be regarded as sufficiently intense and the staining process stopped by washing the preparation in water when the cytoplasm of the giant cells has acquired a bright red colour and the fibrils of the reticulum begin to take on a red colour also. If the staining is found not sufficiently intense the diluted staining fluid is poured back on the preparation and allowed to act longer. Over-staining and the formation of a black-red granular precipitate on the preparation occur if the diluted staining fluid is allowed to act longer than a certain time.

* Publications of the Massachusetts General Hospital, iii. (1910) pp. 1-16 (2 pls.).

2. Dehydrate in pure acetone. On account of the great volatility of acetone some care is necessary to prevent the drying of the preparation, which should be avoided.

3. Clear in pure oil of turpentine.

4. Mount in a thick solution of colophonium in pure oil of turpentine. Before mounting the preparation, the superfluous turpentine should be carefully removed because this reagent rapidly takes up water from the air, and thus may cause the clouding of the preparation or the fading of the stain.

The solution of colophonium is made by saturating a quantity of turpentine with powdered colophonium, and keeping the filtered solution in the paraffin imbedding oven until it has evaporated to the required consistence.

The use of acetone for dehydrating and of oil turpentine for clearing and mounting is an important feature of the method, for these do not destroy the characteristic staining of the granules in the giant cells and platelets as do other similar reagents that have been tested.

The staining fluid is composed of a mixture of 3 parts of a solution of modified or polychromatized methylen-blue and 10 parts of a 0.2 solution of eosin, "w.g." (Grübler) in pure methyl-alcohol. It is permanent if kept in a well-stoppered bottle so that evaporation is prevented.

The solution of methylen-blue is prepared as follows: One gram of methylen-blue, B.X. (Grübler), is dissolved as thoroughly as possible in 100 c.cm. of a 0.5 p.c. aqueous solution of sodium bi-carbonate in an Ehrlemeyer flask. The flask and its contents are then placed in an ordinary steam sterilizer and kept at 100°C. for one hour and a half, counting the time after the steaming has become vigorous. When cool, the mixture is filtered, and the filtrate is the modified blue solution. It must be of a well-marked purple colour when viewed in a thin layer by the yellow transmitted light of an ordinary incandescent electric bulb. This colour appears only after cooling.

It is important that the quantities mentioned should be accurately weighed or measured. An excess of eosin delays the appearance of the scum on the surface of the diluted staining fluid, and the time required for staining will be longer than ten minutes. On the other hand, an excess of the modified blue component hastens the appearance of the scum, and the staining may in ten minutes cause over-staining and the granular precipitate to form on the preparation.

The preparations should be viewed by the light from an incandescent electric bulb which has a yellowish tint. This brings out more strongly the characteristic colour of the granules in the megakaryocytes and in the blood platelets.

Staining Wet Films by Giemsa's Azur-eosin Method.*—G. Giemsa fixes thin smears (malaria, trypanosomes, spirochaetes, and such like) in sublimate-alcohol (2 parts saturated aqueous sublimate solution and 1 part absolute alcohol) for 12 to 24 hours or longer, and then after a short wash in water treats the preparation for 5 to 10 minutes in an iodine solution (iodide of potassium 2 grm., distilled water 100 c.cm.,

* Deutsche Med. Wochenschr. (1909) p. 1751.

Lugol's solution 3 c.cm.). The film is then washed with water and then immersed for 10 minutes in a 0.5 p.c. aqueous solution of sodium thiosulphate. After removal it is again washed with water and then stained with fresh Giemsa solution (1 drop to 1 c.cm. of water, or 2 c.cm. for longer staining) for 1 to 12 hours or longer; after the first half-hour it is necessary to pour off the stain and replace with a fresh lot. After staining, the preparation is treated to the following series: (*a*) acetone 95, xylol 5; (*b*) acetone 70, xylol 30; (*c*) acetone 70, xylol 30; (*d*) pure xylol. Mount in cedar-wood oil.

Staining Blood Smears.*—Hayhurst stains films of blood with the following solutions. (*a*) Water soluble eosin 1, methyl-alcohol abs. 100. (*b*) Medicinal methylen-blue 1, methyl-alcohol abs. 100. Solution *a* is allowed to act for $\frac{1}{2}$ to 1 minute, and then the preparation is at once and without further treatment immersed in solution *b* for $\frac{1}{2}$ to 1 minute. After washing in water for $\frac{1}{2}$ to 1 minute the preparation is dried with blotting-paper and mounted in cedar-wood oil. During manipulation the film should be covered in order to prevent evaporation.

Detection of Tubercle Bacilli in the Placenta.†—J. Novak and F. Ranzel, by means of the antiformin method, have demonstrated in four cases out of six the presence of tubercle bacilli in the placenta of tuberculous women. Pieces of placenta were finely divided and washed until free from blood. Part was then treated with 20 p.c. antiformin, while another portion was fixed in alcohol for 24 hours, dried and ground in a mortar to a fine powder, and then treated with antiformin. By this means the tissue and non-acid-fast bacteria are dissolved. The second method gave the better results, solution being effected in 4 to 5 hours. Alcohol in the proportion of 3 to 2 was added in order to reduce the specific gravity and facilitate sedimentation. The sediment was washed and stained for tubercle bacilli.

Indian-ink Method in Parasitology.‡—B. Galli-Valerio has used the Chinese ink method of Burri in studying spirochaetes, sarcinae and bacteria. This ink he uses in dilutions of 1 in 9, or 1 in 3, in distilled water. The solutions are sterilized, and keep well. A few drops of formalin are added. Excellent preparations of these parasites, white upon a dark ground, are thus obtained, and continued investigations are not accompanied with fatigue.

Staining Nervous Tissues with Methylen-blue.§—After giving an account of the methods employed by Ehrlich and others for the demonstration of nerve-cells and nerve-fibres by means of this stain, S. Michailow describes his own technique as applied to the study of these structures in the mammalian heart. After the animal has been killed, the heart is removed and then left untouched for two hours. After this interval, it is washed in Ringer-Locke's saline solution at body temperature until the washings are no longer discoloured. The

* Journ. American Med. Assoc., lii. (1909) No. 14.

† British Med. Journ. (1910) ii. epit. 125.

‡ Centralbl. Bakt., 1^{te} Abt. Orig., lvi. (1910) pp. 46-7.

§ Zeitschr. wiss. Mikrosk., xxvii. (1910) pp. 1-21.

organ is then suitably sliced with a sharp razor, and the slices are transferred to glass dishes for staining. The bottom of these dishes is covered with two or three layers of filter paper. The stain is prepared as a stock solution of 1 grm. of Grübler's methylen-blue in 200 c.cm. of a saline fluid, and from this suitable dilutions are made. For nervous tissues, $\frac{1}{4}$ or $\frac{1}{3}$ p.c. solutions are used. The warmed stain is poured over the material from a pipette, and staining proceeds at a temperature of 37° C. At intervals the material is examined, to see whether the process has gone far enough. As fixing fluid, a solution is used which contains 8 grm. of ammonium molybdate, and 0·5 c.cm. of formalin in 100 c.cm. of distilled water. The material is transferred to this fluid, suitably warmed, and left for 24 hours. Then it is well washed in warm water, dehydrated in alcohols, cleared in oil of bergamot and xylol, and finally mounted in damar-xylol.

Preparation of Ammoniacal Silver Solution.*—A. Schlenmer describes an improved method for the preparation of this fluid, which is used in Bielschowsky's process for demonstrating connective-tissue fibres in bone, dentine, and elsewhere. To a 10 p.c. solution of silver nitrate is added 40 p.c. sodium hydrate in excess, and the precipitate which forms is washed free of alkali. This precipitate is then dissolved in as little ammonia as possible, and the solution is filtered through glass wool. This solution is diluted with 9 parts of water, and is then ready for use.

Toluidin-blue.†—L. Martinotti calls attention to a solution of toluidin-blue with which he has got results as good as those obtained with polychrome-blue. It has the following composition:—Toluidin-blue 1 grm., lithium carbonate 0·5 grm., distilled water 75 grm., glycerin 20 grm., alcohol (95 p.c.) 5 grm. The first two ingredients are dissolved completely in the water, before adding glycerin and alcohol. The method of staining is precisely the same as with polychrome-blue. The solution is readily prepared.

Hæmatin Stains.‡—L. Martinotti gives three formulæ for hæmatin solutions, of which the first two are based respectively upon Delafield's and Unna's hæmatoxylin. They contain 0·2–0·5 p.c. of hæmatin, and varying proportions of methyl-alcohol, alum, glycerin, and hydrogen peroxide. The results are constant and satisfactory; the solutions are easily prepared, and keep well.

Chemistry of Vegetable Pigments.§—L. E. Cavazza gives an account of his microchemical researches upon the colouring matters of certain flowers, fruits and leaves. He classifies these substances into fifteen groups, and gives in tabular form the effects of certain chemical reagents upon the members of the different groups.

New Dahlia Stain.||—Ballenger describes a new stain for motile organisms, renal tube casts, and fixed smears of *Spirochæta pallida*.

* Zeitschr. wiss. Mikrosk., xxvii. pp. 22–3.

† Tom. cit., pp. 24–9.

‡ Tom. cit., pp. 30–3.

§ Tom. cit., pp. 34–40.

|| Centralbl. Bakt., 1^{te} Abt. Ref., xlvii. (1910) p. 407.

Dahlia is made up with 90 p.c. alcohol in 10 p.c. solution. One drop of a 10 p.c. solution of this fluid in water is mixed with the suspension of casts or bacilli, and covered with a cover-slip. The slide is then examined directly without removing the excess of stain. For examining fixed smears a 5-6 p.c. watery solution of dahlia is used.

Stable Solution of Gentian-violet.*—Kilduffe recommends the following as a stable solution of this stain for use in Gram's process:—Saturated gentian-violet solution, 25 p.c. ; 5 p.c. formalin, 75 p.c.

Staining Prowazek's Bodies.†—K. Lindner describes a method of staining by means of which these cell-inclusions—the causal agents of trachoma—may be demonstrated and readily distinguished from artefacts. A film is made upon a cover-slip, dried in air, and fixed in absolute alcohol. It is then left for 1 hour in a solution containing five drops of Giemsa and one drop of 1 p.c. acetic acid in 10 c.cm. of distilled water. Then it is dried and mounted. On a film so stained, these bodies appear dark blue or pale blue, the early stages being strongly basophil, the later stages less markedly so. The films show contrast-staining of such a type that it is a relatively easy matter to pick out these bodies during rapid examinations of microscopic fields.

(5) Mounting, including Slides, Preservative Fluids, etc.

Mounting Serial Celloidin Sections.‡—N. Anitschow makes use of the following method. The sections as they are cut are placed in 65 p.c. alcohol and transferred by means of a spatula to albuminized slides. By means of a small forceps, they are carefully spread upon the slide. This process may be facilitated by the use of 98 p.c. alcohol, which softens the celloidin. When quite flat, the sections are pressed firmly down with filter paper. Then a mixture of anilin and clove-oil, or of alcohol and formalin, is poured over the slide, and pressure is again applied. The sections are then washed thoroughly with acetone, to remove all traces of celloidin. The acetone is washed off with water, but in the case of delicate tissues an intermediate treatment with 70 p.c. alcohol is advisable.

Mounting Frozen Sections.§—N. Anitschow describes his method as follows. By means of a spatula the sections are removed from the microtome to a dish containing 50 p.c. alcohol, and from this to albuminized slides. The sections are spread out carefully, and pressed down carefully with filter paper. The slide is then placed in 98 p.c. alcohol for half a minute, transferred to 70 p.c. alcohol, and finally to water. If, however, it is proposed to stain the sections for fat, the slide is placed instead in 50 p.c. alcohol-formalin, and then transferred direct to water.

(6) Miscellaneous.

Gelatin Plates for Graphic Reconstruction.||—A. Pensa gives a brief account of his method of using sheets of compressed gelatin for

* *Centralbl. Bakt.*, 1^{te} Abt. Ref., xlvii. (1910) pp. 407-8.

† *Op. cit.*, 1^{te} Abt. Orig., xlvii. (1910) pp. 429-32.

‡ *Zeitschr. wiss. Mikrosk.*, xxvii. (1910) pp. 67-70.

§ *Tom. cit.*, pp. 71-4.

|| *Tom. cit.*, pp. 48-50.

the graphic reconstruction of organs or anatomical structures. Outline sketches representing successive sections through the region under investigation are made upon a series of these sheets and suitably coloured. They are then built up in order, the correct centring of each diagram being secured by bringing salient points into apposition. The sheets are then stuck together by means of a hot iron applied to a corner at a safe distance from the diagram. This method is peculiarly suitable for the study of regions that are not unduly complex, and where the number of sheets required is not so great as to interfere with transparency or clearness.

Morphological Demonstration of Methæmoglobin in Blood.*—G. Krönig has studied dried films of blood from cases of methæmoglobinæmia, with a view to finding out the details of the process of formation of methæmoglobin. After slow and careful heat fixation, films were stained either by the methylen-blue-eosin or hæmatoxylin-eosin method. From cases of poisoning with maretin and potassium chlorate, he obtained films which showed distorted erythrocytes, hæmoglobin and methæmoglobin debris. Granules of pigment ingested by leucocytes were observed. In films treated with an acid stain, small portions of protoplasm were seen adherent to the pigment clumps. By this method, it is possible to demonstrate methæmoglobin even when a negative result is obtained with the spectroscopie.

SHAW, E. H.—**The Immediate Microscopic Diagnosis of Tumours at the time of Operation.** *Lancet* (1910) ii. p. 939. See also this Journal, 1907, p. 244.

Metallography, etc.

Metallography of Zinc.†—The impurities which may occur in commercial zinc are lead, iron, cadmium, arsenic, antimony, tin, bismuth, and copper. With the intention of applying the results to the examination of commercial zinc, P. T. Arnemann has studied the zinc-rich binary alloys of zinc with the metals mentioned. The method adopted was to construct the equilibrium diagram for the desired range from cooling curves of the alloys prepared and from published data, and to examine micro-sections. The softness of many of the alloys rendered the polishing of sections very difficult; surfaces for examination were therefore obtained by casting on smooth surfaces. Glass, mica, quartz, and steel were found to be unsatisfactory for this purpose, but good preparations were obtained by allowing the molten alloy to solidify slowly in a small wooden ring placed on the bottom of an inverted carbon crucible heated by a gas burner. The lower face of the small ingot obtained did not show the markings of the carbon surface in contact with which it had solidified, but had the crystalline structure of the alloy. Alloys which could not be prepared in this way were cut and polished. Among the etching reagents used were dilute nitric acid, hydrochloric acid in alcohol, and dilute copper-ammonium chloride solution. The thermal and micro-

* *SB. der k. Preuss. Akad. Wiss.* (1910) pp. 539-47.

† *Metallurgie*, vii. (1910) pp. 201-11 (65 figs.).

scopical results are too lengthy for reproduction. The data obtained permitted the identification of some impurities in samples of zinc examined.

Bearing-metals and Stamped Alloys.*—By a process somewhat resembling that described by Friedrich,† W. Guertler has made bearing-metals consisting of grains of a hard metal imbedded in a plastic matrix. An intimate mixture of iron and lead in fine powder was heated to 250° to 300° C. and stamped in moulds. The properties of the product appeared to be satisfactory.

Copper-aluminium-manganese Alloys.‡—W. Rosenhain and F. C. A. H. Lantsberry have made a lengthy investigation of a number of alloys belonging to this ternary system. The alloys studied fall into two classes: (1) heavy alloys, containing 0 to 11 p.c. aluminium, 0 to 10 p.c. manganese, rest copper; (2) light alloys, containing copper and manganese, not more than 4 p.c. of either, rest aluminium. Mechanical tests, static, impact, and alternating-stress, were carried out on the alloys in different states—sand-castings, chill-castings, bars, as rolled, annealed, or quenched, etc. Cooling curves were taken, and the alloys were microscopically examined. The complexity of the ternary system renders the determination of its equilibrium diagram a matter of great difficulty, and a complete explanation of the results obtained in the limited regions of the diagram which include the alloys investigated is not attempted. The constitution of the heavy ternary alloys closely resembles that of the copper-aluminium alloys: in no case does manganese give rise to the formation of a third phase, so that all the alloys consist of either a single solid solution (the α body) or of two phases, in each of which manganese exists in a solid solution. The compound Cu_3Al appears to be capable of dissolving manganese, and there is no evidence of the formation of a ternary compound. In the light alloys, three distinct phases are found: (1) a solid solution, which is aluminium containing some copper but practically no manganese; (2) the compound CuAl_2 ; (3) the compound Al_3Mn . A ternary eutectic of these three phases, freezing at 522° C., is probably present in most of the light alloys. No thermal changes were found below the point of final solidification of the aluminium-rich alloys. Corrosion tests were made on the alloys, and in some cases magnetic properties were studied.

Action of Hydrogen and Nitrogen on Temper-carbon in Iron.§
It has been stated by Forquignon and by Charpy that temper-carbon in iron is volatilized, as hydrocarbons when heated in hydrogen, as cyanogen when heated in nitrogen. This has been disputed by Wüst and Geiger. F. Wüst and E. Sudhoff have now carried out a fresh series of experiments, samples of cast iron, containing about 1.5 p.c. temper-carbon and about 1.1 p.c. combined carbon, being heated, at temperatures 880° to 1080° C., in carefully purified hydrogen and nitrogen. No loss of total carbon occurred in either case, but while the carbon condition was un-

* Metallurgie, vii. (1910) pp. 264–8. † See this Journal, 1910, p. 530.

‡ Proc. Inst. Mech. Eng. (1910) i. pp. 119–339 (141 figs.). (Ninth report to Alloys Research Committee.)

§ Metallurgie, vii. (1910) pp. 261–4 (4 figs.).

affected by heating in nitrogen, some 0.7 p.c. temper-carbon was changed to combined carbon by heating in hydrogen. Microscopical examination of the specimens confirmed the chemical analyses.

A₂ Point in Chromium Steel.*—H. Moore has observed that in a series of steels containing up to 6.4 p.c. chromium, the position of Ac₁ was progressively raised by increase of chromium-content. When more than 3 p.c. chromium was present, a critical point occurring below Ac₁ was observed. After rejecting several possible explanations, the author concluded that this apparently new critical point was Ac₂, and, to test this conclusion, devised a method for determining accurately the temperature at which steel loses or regains its magnetic properties on heating or cooling. The identity of the critical point in question with the magnetic change-point proved it to be Ac₂. The addition of chromium to steel, raising Ac₁ while not affecting the position of Ac₂, causes a reversal in the relative positions of Ac₁ and Ac₂ when 3 p.c. or more chromium is present. The author holds that the occurrence of Ac₂ below Ac₁ demonstrates the insolubility of carbide of iron in β -iron.

Chromium Steel.†—A. McWilliam and E. J. Barnes have made tensile and alternating-stress tests upon six steels containing 2 p.c. chromium, about 0.2 p.c. manganese, the carbon varying from 0.2 to 0.85 p.c. The steels were tested after treatments similar to those given in a previous investigation.‡ Heating curves showed a critical point, assumed to be Ac₂, below Ac₁. Cooling curves were also taken. The thermal analysis, and microscopical examination of the steels after different heat-treatments, would indicate that the carbon content of pearlite, when 2 p.c. chromium is present, is decidedly lower than that of pearlite in steels containing no chromium.

Case-hardening.§—S. A. Grayson has investigated the case-hardening efficiency of four commercial materials. Turned test-pieces of mild steel were heated in these materials, at different temperatures, and for varying lengths of time. Carbon was then estimated in thin layers successively turned off, and sections, the edges of which were protected from rounding in polishing by electro-deposited copper, were examined microscopically. The best temperature appears to be 950° to 1000° C. Sulphur may be absorbed by the steel from case-hardening compositions, with deleterious effects. Large quantities of the sulphides of manganese and iron were observed at the edges of sections which had been case-hardened in compositions containing notable amounts of sulphur.

Constitution of Cast Irons and Carbon Steels.||—D. M. Levy suggests, as a simplified view of the iron-carbon system, that the alloys may be considered as a series of alloys of iron with iron-carbide. A "constitutional diagram" based on this view is given, and the changes which occur in the solidification and cooling of alloys of different carbon content are discussed in detail, being regarded as the separation of carbide of iron

* Journ. Iron and Steel Inst., lxxxi. (1910) pp. 268-75 (2 figs.).

† Tom. cit., pp. 246-67 (15 figs.).

‡ See this Journal, 1909, p. 787.

§ Journ. Iron and Steel Inst., lxxxi. (1910) pp. 287-303 (17 figs.).

|| Tom. cit., pp. 403-30 (2 figs.).

from either liquid or solid solution in iron. The metastable iron-carbide always tends to decompose into carbon and iron. The effect of foreign elements upon the diagram is considered.

Effect of Low Temperature on Iron-carbon Alloys.*—C. W. Wagoner has determined the magnetic permeability and the magnetic hysteresis of seven iron-carbon alloys containing 0.6 to 1.37 p.c. carbon, and of iron containing 0.06 p.c. carbon, at liquid air temperature and at 20° C. The mean coefficient of linear expansion was determined from room temperature to liquid air temperature, and was found to decrease with increase of carbon.

Cementation by Gases.†—J. C. Olsen and J. S. Weissenbach have determined the depth and intensity of cementation of iron rods heated in illuminating gas, methane, carbon monoxide, and acetylene. In one series of experiments ammonia gas was added to the gaseous cementation medium, and was found to facilitate the absorption of carbon by the steel except in the case of carbon monoxide. Of the three pure gases, carbon monoxide is the most efficient in cementation.

Heat Treatment of Special Steels.‡—L. Guillet classifies alloy-steels, and gives some generalizations as to their treatment. In nickel- and silicon-steels, the carbide goes into solution less readily than in other steels, while annealing at high temperatures appears to have a much less injurious effect than in the case of carbon steels. Other special steels are more sensitive to such annealing. The quenching of polyhedric steels at 1000° C., so frequently practised, appears to be highly injurious. The author has found in steels so treated a coarse network resembling that observed in "burnt" steels.

Thermal Treatment of Cemented Steel.§—L. Guillet recommends the double quenching of cemented articles, the first from a high temperature (up to 1000° C.) to restore the structure and qualities of the body of the steel, the second quenching from 750° C., or thereabouts, to harden, and produce a fine structure in, the carbonized layer on the surface. The tempering of hardened cemented steel at about 200° C. has been found to improve its qualities.

Artificial Reproduction of Widmanstätten Figures.||—N. Belaiev has obtained meteorite-like structures in medium carbon steels by heating the molten metal to a high temperature and cooling it very slowly. The Widmanstätten structure was sufficiently coarse to be perceived by the unaided eye. The author attempts a theoretical explanation of the formation of this structure in meteorites, which are natural iron-nickel alloys.

"Strain-disease" in Steel.¶—After referring to Cohen's investigation of the effect of cold-working upon tin, G. Charpy points out that the growth of the ferrite grains in annealing is much more rapid in steel

* Physical Review, xxviii. (1909) pp. 393-404 (6 figs.).

† American Machinist, xxxii. (1909) pt. 2, pp. 156-8 (1 fig.).

‡ Rev. Métallurgie, vii. (1910) pp. 489-95.

§ Tom. cit., pp. 501-9 (16 figs.).

|| Tom. cit., pp. 510-21 (15 figs.).

¶ Tom. cit., pp. 655-6.

that has been cold-worked than in the same steel not submitted to such mechanical treatment. The phenomenon is most strongly marked in steels containing very little carbon and at the same time somewhat phosphoric. The linear dimensions of crystalline grain after annealing, in such a steel, in a part previously cold-worked, may be as much as ten times the dimensions of grain in a part which has not undergone cold-work. Annealing temperatures of 650° to 800° C. bring out these differences well.

Application of Titanium Alloys in the Steel Industry.*—W. Venator has divided three charges of basic open-hearth steel each into two portions, to one of which was added titanium, none being added to the other: 0.038, 0.092 and 0.14 p.c. titanium were added, but only traces were found in the steel. The author considers that the mechanical properties of the steel were distinctly improved by the titanium addition. The titanium appears to have a reducing and purifying action, possibly removing traces of nitrogen also.

Effects Produced by Rolling.†—H. Meissner and H. Felsler have examined, chemically and microscopically, specimens taken from various descriptions of mild steel and puddled iron at different stages in the process of rolling. While no alteration in chemical composition took place in the mild steel, a considerable reduction in the amount of slag imprisoned in the puddled iron occurred during the rolling, as much as 80 p.c. of the slag being removed. The size of the ferrite grains diminished, and curves are given showing the gradual reduction in grain size during rolling. Mechanical tests were taken at various stages.

Apparatus for Metallographic Work.‡—S. S. Knight describes a metallographical equipment which he finds satisfactory, after discarding four complete outfits in turn. The camera is vertical, and may be swung back out of the way for visual examination. The illuminating apparatus, comprising an acetylene burner enclosed in a sheet-iron chimney, and a condenser, is clamped to the Microscope tube, and thus follows the movement of the lens. Very little light escapes into the room. A cover-glass illuminator is preferable to one of the prism type. As the two influences controlling the quality of iron and steel are composition and heat-treatment, the author considers that metallographical examination almost completely supplements chemical analysis.

Metallography in German and Belgian Laboratories.§—G. Arnou reports on his visit to various German and Belgian iron and steel works, undertaken to study the organization and equipment of their laboratories. At the Krupp establishment, levigated emery-powder is used for the final polishing of sections; alumina is more commonly used elsewhere. Hydrochloric acid is frequently preferred to picric or nitric acid for etching, while etching for macroscopic examination, which is widely practised, is usually performed by means of Heyn's copper-ammonium-chloride reagent. For the detection of sulphides the

* Stahl und Eisen, xxx. (1910) pp. 650-4 (14 figs.).

† Tom. cit., pp. 287-90 (9 figs.).

‡ Iron Age, lxxxv. (1910) p. 279 (1 fig.).

§ Rev. Métallurgie, vii. (1910) pp. 405-28 (16 figs.).

Baumann sulphur-printing method is commonly used; but Heyn declares that sulphides are not distinguished from phosphides by this method, and recommends the use of silk soaked in a solution of hydrochloric acid and mercuric chloride. The Le Chatelier Microscope is generally employed in works laboratories, while the Martens outfit is more frequently installed in scientific establishments. An arc-lamp, with its carbons set at right angles to each other, by the Düsseldorf firm of Dujardin, is frequently used for photomicrography. The same firm also supplies several types of Microscope stand, polishing apparatus, etc. The Stead workshop Microscope is used in cases where more costly outfits are unsuitable or not considered necessary. Instances of the practical application of metallographical results and examples of the mode of reporting them are given. Numerous details relating to mechanical testing, pyrometry, and heat-treatment are furnished.

Testing Steel by Corrosion.*—F. Cloup gives some information about the application of macroscopic etching, which he terms "testing by corrosion," to steel. He has used picric acid as an etching reagent, but recommends a 10 p.c. iodine in potassium iodide solution. A specular polish is unnecessary, but it is advisable to carry the polishing as far as may be practicable. Suitably etched specimens give clear indications of the manner of flow of the metal in the mechanical treatment (forging, stamping, etc.) which it has undergone, and the position and extent of segregation, piping, blowholes, and other defects are revealed. With steel of good quality, free from defects, prolonged etching is necessary to develop the flow-lines.

Heat-capacity of Metals and Compounds.†—H. Schimpff has determined the heat-capacity of fifteen metals and twenty-nine binary compounds of the metals with each other, for the temperature intervals 17° to 100° C., 17° to -79° C., 17° to -190° C. The molecular heats of about one-half the compounds are equal to the sum of the atomic heats of the component metals, within 2 p.c., the limit of experimental error. In the remaining cases the deviations from Kopp's law are usually within 4 p.c. Specific heat increases with temperature, but the value of the temperature-coefficient diminishes as the temperature rises, except for bismuth and lead.

Resistance of Alloys free from Solid Solutions.‡—K. Lichtenecker has deduced a simple formula for the calculation of the electrical resistance of alloys containing no solid solutions. A satisfactory agreement was obtained between observed values and values calculated from this formula.

Spark Spectra of the Metals.§—C. E. Gissing gives good reproductions of photographs of the spark spectra of most of the metals and a few alloys. Containing, in addition, numerous manipulative details, the book should be useful to those who use a prism spectroscope for the

* Rev. Métallurgie, vii. (1910) pp. 605-11 (9 figs.).

† Zeitschr. Phys. Chem., lxxi. (1910) pp. 257-300 (8 figs.).

‡ Phys. Zeitschr., x. (1909) pp. 1005-8, through Science Abstracts, xiii. (1910) Section A, p. 150.

§ London: Baillières, Tindall and Cox, 21 pp. (50 figs.).

qualitative analysis of metal-bearing substances. The lines characteristic of each component, can usually be detected in the spark spectrum of an alloy.

National Physical Laboratory.*—An investigation of the aluminium-zinc alloys has revealed certain inaccuracies in Shepherd's equilibrium diagram, the true diagram being more complex. The eutectics research was continued in several directions. Antographic cooling curves, taken with extremely sensitive apparatus, did not give any indication of two separate stages in the solidification. Various eutectic alloys were made to cool very slowly through their solidifying points, and were submitted throughout this cooling to the action of a centrifuge. Speeds of rotation up to 2500 per minute were used. The lead-tin eutectic after this treatment did not show any signs of separation into the two metals, but in the lead-bismuth and tin-bismuth eutectics a considerable amount of separation took place. Various improvements have been introduced into the methods for determining temperature-density curves. A more complete apparatus has been designed for studying the effects of strain at high temperatures; this consists of an instrument for applying accurately measured stresses to thin strips of metal heated in a small electric tube furnace in a high vacuum. The plastic extension of the specimens may be measured with some accuracy. A new Leitz arc lamp, having the carbons set at right angles, has been installed for use with the photo-micrographic apparatus. For the microscopical study of transverse sections of tin plate, imbedding in electrolytic iron has been tried with success.

Properties of Non-ferrous Metals.†—An extended study of the elastic breakdown of copper, aluminium, Muntz metal and other brasses has led C. A. M. Smith to conclude that any one of these materials has either a very indefinite yield-point, or else varies considerably in its elastic properties. The effects of overstrain, and of heating overstrained metals at 100° C. by placing in boiling water, were studied. Very delicate measurements of strain were made by means of the sphingometer. The mild steel tested appeared to be more homogeneous than any of the other metals.

Mixed Crystals or Solid Solutions? ‡—St. Ruzicka has made some experiments on organic bodies to test van 't Hoff's theory that mixed crystals (isomorphous mixtures), as well as amorphous mixtures (glasses, alloys), are to be regarded as solid solutions, and that accordingly diffusion should take place in the crystals. The author found that no diffusion occurred in the crystals examined.

Metallographical Study of Slags.—With a view of identifying the various substances which compose the inclusions of slag found in iron and steel, Matweiff has prepared synthetically, and examined microscopically, oxides, sulphides and silicates of iron and of manganese. Each compound was melted, as a rule, in contact with iron. Of several

* Nat. Phys. Laboratory, Rep. for 1909, pp. 79-88.

† Journ. Inst. Metals, ii. (1909) pp. 151-230 (44 figs.).

‡ Zeitschr. Phys. Chem., lxxii. (1910) pp. 381-2.

§ Rev. Metallurgie, vii. (1910) pp. 447-55 (18 figs.).

etching reagents tried, three were found to be specially useful—hydrogen, water vapour, and an organic acid (such as tartaric acid) in the form of a solution in water. The two gaseous reagents were applied by passing them over the heated section. The constituents of ferruginous slags may be classified into three groups:—1. Bodies not attacked by any of the three etching reagents; these are silicates of iron and silicates of manganese. 2. Bodies attacked by hydrogen and water vapour, but not by organic acids; these are the oxides. 3. Bodies attacked by organic acids, but not by the two gaseous reagents; these are the sulphides of iron and of manganese. Methods of distinguishing iron from manganese in the various compounds are given.

GUYE, C. E., & H. SCHAPPER—**Internal Friction of some Metals at Low Temperatures.** *Archives des Sciences physiques et naturelles (Geneva)* xxx. (1910) pp. 133-51 (23 figs.).

HEGG, F.—**Thermomagnetic Study of Ferro-nickels** *Tom. cit.*, pp. 15-45 (17 figs.).

TURNER, L. B.—**Stresses in a thick hollow Cylinder subjected to Internal Pressure.** *Trans. Cambridge Phil. Soc.*, xxi. (1910) pp. 377-96 (8 figs.).

ARNOLD, J. O.—**Uniform Nomenclature of Iron and Steel.** *Journ. Iron and Steel Inst.*, lxxx. (1910) pp. 185-205 (2 figs.).

ARNOLD, J. O., & A. A. READ—**Chemical and Mechanical Relations of Iron, Manganese, and Carbon.** *Tom. cit.*, pp. 169-84 (7 figs.).

SMITH, C. A. M.—**Elastic Breakdown of Certain Steels.** *Tom. cit.*, pp. 431-66 (31 figs.).

TAGUEFF, G.—**Homogeneity of Metals.** *Tom. cit.*, pp. 467-89 (10 figs.).

PROCEEDINGS OF THE SOCIETY.

MEETING

HELD ON THE 19TH OF OCTOBER, 1910, AT THE DORÉ GALLERY,
NEW BOND STREET, W. ; E. J. SPITTA, ESQ., M.R.C.S., ETC..
VICE-PRESIDENT, IN THE CHAIR.

The Minutes of the last Meeting, held on the 15th of June, 1910, were read and confirmed, and were signed by the Chairman.

The List of Donations (exclusive of exchanges and reprints) received since the last Meeting, was read, as follows, and the thanks of the Society were voted to the donors :—

	From
Gissing, C. E., Spark Spectra of the Metals. (4to, London, 1910)	The Publishers.
Greenish, H. G., The Microscopical Examination of Foods and Drugs. (8vo, London, 1910)	The Publishers.
Herzog, Alois, Die Unterscheidung der natürlichen und künstlichen Seiden. (Svo, Dresden, Theodor Steinkopff, 1910)	The Publishers.
Lafar, Franz, Technical Mycology, ii. pt. 2. (8vo, London, 1910)	The Publishers.
Southall, J. P. C., The Principles and Methods of Geometrical Optics. (8vo, New York, The Macmillan Co., 1910)	The Publishers.
Portrait of Mr. Frank Crisp, from Vanity Fair	Mr. R. T. Lewis.
Lucernal Microscope by Adams, with a portion of vol. xi. pt. 2, pp. 709-60, of an early edition of the Encyclopædia Britannica, containing "On The Microscope, including figures and description of the Lucernal Microscope"	Mr. Frank Slade.
Microscope by Hugh Powell, date 1840	Mr. P. T. B. Beale.
Block of Cumming's "Cutting Engine"	Mr. C. Lees-Curties.

An abstract of a paper by Mr. Jas. J. Simpson, on "*Hicksonella*, a New Gorgonellid Genus," was read by Dr. Hebb, the President, who was to have been present to read the paper in its entirety, having been unavoidably prevented from attending the Meeting. A specimen of the new genus was exhibited.

The Chairman thought it was difficult to make any remarks on such a paper without reading it in its entirety, as an abstract treated merely of practical details. The specimen exhibited was evidently something new, and claimed the notice of the Society, and was well worth the study of the Fellows afterwards.

The thanks of the Meeting were voted to Mr. Simpson for his paper and specimen.

A paper by Mr. Heron-Allen and Mr. Earland upon "Some Varietal Forms of *Massilina secans*," was read by Mr. Heron-Allen.

Mr. Earland said that he did not think that he had anything to add

to what had just been read, except that he was sure that the origination of the varieties of *Massilina secans* in the tank was due to the exhaustion not merely of carbonate of lime, but of other chemical salts which would lead to the abnormal formation of the shells. Ornament in the Foraminifera, when due to an exuberance or abundance of shell material, usually took the form of spines or bosses. Whenever ornament took the form of striae or sulci, he thought it pointed to exhaustion of material, as borne out by the remarks made in the paper.

Mr. Maurice Blood said that the formation of striae, when shell-forming material is scarce, is a remarkable example of adaptation in such a lowly organism as a ribbed form of shell would be obviously stronger than a smooth shell with a similiar amount of material.

The Chairman concluded he meant in addition to the spines.

Mr. Blood said No, the converse. Striae were owing to lack of material and tended to make a body stronger, in the same way that any body of whatever shape made in ribbed form (as, for example, corrugated iron) proved to be stronger than a smooth body of the same shape and made in the same amount of material.

The thanks of the Society were unanimously voted to Mr. Heron-Allen and to Mr. Earland for their interesting paper.

Mr. E. M. Nelson's paper, "A Micrometric Difficulty," was read by Mr. Scales.

Mr. Nelson's paper, "On the Resolution of New Detail in a *Coscinodiscus asteromphalus*," was read by Dr. Hebb, a blackboard illustration being exhibited.

The Chairman said that such papers as those which had just been read were sometimes more difficult to follow than to read, and it required an examination of the diatom in question to see whether Mr. Nelson's remarks carried as much weight as might be gathered from hearing his paper. He (the Chairman) knew the diatom mentioned very well indeed, and he fully recognized that it was one thing to discover new details, but quite a different matter to simply recognize them after they had been discovered. He confessed that he had never himself come across the markings described, but his attention had never been drawn to them. It must be borne in mind, too, that the discovery of new details in a diatom so well known and frequently used might be due to using an objective whose correction just happened to suit the object in question—hence the advantage in work of this kind of employing objectives of similar focal length and aperture by different makers. Testing objectives by diatoms only was not to be commended, as he had pointed out elsewhere, save under special conditions. He remembered an optician once telling him, "If you say what diatom you wish to study, I will make you an objective specially for it."

The thanks of the Meeting were voted unanimously to Mr. Nelson for his papers.

The Chairman announced that the Council wished him to state that acknowledgments of the Addresses of Condolence sent by the

Society to the King and Queen Mother, on the occasion of the death of His late Majesty King Edward VII., had been received.

The Chairman further said that they had all to regret sadly the loss of one of the well-known members both of the Quekett Club and of their own Society. He had been a regular attendant and a constant speaker. Some constant speakers were not always so acceptable as they might be—that was to say, that their remarks were not always of much use—but Mr. Walter Wesché had always something to say which was to the point; what was more, he took particular care to say it in an intelligible way, and always in such an agreeable manner. He was a valuable Fellow and a sincere friend. As a medical man, he (the Chairman) could not help noticing his gradually failing health, and this had been a source of great grief to him, but even this had not prepared him for the announcement of his death, which he had seen but a few weeks since in the papers.

He was quite sure, without putting a painful matter to the vote, that all present would wish notified on the minutes their desire to express a vote of sincere sympathy to Mr. Wesché's relatives on the occasion of their bereavement, and of the loss they felt the Society sustained by his death.

The thanks of the Meeting were voted to those Members of the Society and of the Quekett Microscopical Club who had taken so much trouble in arranging the exhibition of Pond Life, which had contributed so much to the enjoyment of the evening.

The following Instruments, Objects, etc., were exhibited:—

Dr. Hebb:—The type Specimen of the New Genus *Hicksonella*, in illustration of Mr. Simpson's paper; Diagram in illustration of Mr. Nelson's paper "On the Resolution of New Detail in a *Coscinodiscus asteromphalus*."

Mr. E. Heron-Allen and Mr. Arthur Earland:—Foraminifera, Variations in *Massilina secans* from Selsey Bill.

Specimens of Pond Life, as follows:—

Mr. F. W. Watson Baker:—*Bursaria truncatella*; *Melicerta conifera*.

Mr. Arthur C. Banfield:—*Gerris* (*Limnotrechus* sp.); *Ophrydium versatile*.

Mr. Jas. Burton:—Section of *Azalea* showing Anabtena in cavities in leaves.

Mr. C. Campbell:—Diatoms.

Mr. F. W. Chipps:—*Melicerta tubicularia*.

Mr. T. N. Cox:—*Anacharis*, longitudinal section of Stem, showing cycloses.

Mr. Edgar Cuzner:—*Lophopus crystallinus*.

Mr. Th. A. Delcomyn:—*Stephanoceros Eichhornii* and Floscularia.

Mr. J. Dick:—Baby Anemone from Marine Aquarium.

Mr. H. E. Freeman:—*Plumularia similis* with tentacles expanded.

Mr. Chas. E. Heath:—*Lophopus crystallinus*.

Mr. A. E. Hilton:—Group of *Hydra viridis*.

- Mr. Hy. E. Hurrell :—*Lophopus crystallinus*.
 Mr. A. Morley Jones :—Cyclosis in Leaf of *Anacharis*.
 Mr. J. Milton Offord :—*Hydra viridis* ; *Volvox globator*.
 Mr. F. J. W. Plaskitt :—*Surirella*, showing Endospores.
 Mr. C. F. Rousselet :—Rotifera, various.
 Mr. D. J. Sounfield :—*Perucantha truncata* with winter egg, showing thickening of chitin on back ; ditto, with winter egg, showing line of special cells running across valves. The anterior ventral portion of the valves breaks away along this line.
 Mr. T. J. Smith :—*Hydra viridis*.
 Mr. C. D. Soar :—*Brachypoda versicolor*, nymph.
 Mr. H. Taverner :—*Brachypoda versicolor*, ♀
 Mr. Geo. Tilling :—*Cristatella mucedo*.
 Mr. W. T. Waller :—*Lophopus crystallina*.
 Mr. J. C. Webb :—*Melicerta* sp.
 Mr. J. Wilson :—*Plumatella repens* ; *Stephanoceros Eichhornii*.

MEETING

HELD ON THE 16TH OF NOVEMBER, 1910, AT 20 HANOVER SQUARE, W.
 PROFESSOR J. ARTHUR THOMSON, M.A. F.R.S.E., PRESIDENT, IN THE CHAIR.

The Minutes of the last Meeting, held on the 19th of October, 1910, were read and confirmed, and were signed by the President.

The List of Donations (exclusive of exchanges and reprints) received since the last Meeting was read, as follows, and the thanks of the Society were voted to the donors :—

Two Slides of <i>Pleurosigma</i>	From	Hon. T. Kirkman.
Old Ivory Sliders containing objects, and Slider contain- ing "magnifiers" in a brass holder	}	Mr. H. C. Gooding.
Old Pocket Magnifiers in brass box		Mr. Chas. Lees Curties.
Slide of Eggs of <i>Trochodota</i> ; ditto <i>Gorgonia</i> spicules ;	}	Mr. M. J. Allan.
Six Slides, miscellaneous		Mrs. Wesché.
Microscope by Oberhauser and Hartnack		

In connexion with the donation of two slides of *Pleurosigma* Dr. Hebb read the following extract from a letter received from the Hon. T. Kirkman : " May I ask you to give me what information you can as to the rarity or otherwise of fresh-water *Pleurosigmæ* with oblique striæ and their value as such to collectors, also is it possible to say with any certainty, without sending the raw material, what is the name of the species to which this form belongs ? Should these two slides be of any interest to the Society, will you kindly ask them to accept them as a contribution to the Cabinet."

Dr. Hebb also read the following extracts from letters received from Mr. M. J. Allan, of Geelong: "If you thought the remaining half-dozen mounts would be of interest to the members of your Society, I should be glad if you would exhibit them and dispose of them in the following manner, if it should meet with your approval—one slide each might be given to any working member, who would undertake to send me in return a slide containing an object of interest, or failing this, if your Society has a cabinet in which contributions of microscopic subjects are kept, I should be very pleased if you consider the mounts worthy of a place in your Society's cabinet. I will leave this matter entirely in your hands. I should also be pleased if any of your members could oblige me with a small quantity of cleaned diatoms suitable for group mounting."

"About four years ago I designed a variable eye-piece giving three magnifying powers, it also magnifies the field in the same ratio; this is a great advantage in working with low powers, the whole of the object being always in view. If you thought it would be of interest to the workers in your Society I would send one, if you would kindly undertake to give a demonstration at one of your meetings, and return it."

In another letter he writes: "Will you kindly inform the Fellows of your Society that I greatly appreciate their vote of thanks, and shall be pleased to forward any subject that I consider would be of special interest to them."

And in reference to the slides mentioned above he says: "I would be glad if you would kindly draw the attention of Members to two of the mounts, as I should like to know the opinion of those interested in that class of work. I refer to a mount of Moss in fluid which should be viewed with a dark-ground illumination, the other a flower also mounted in fluid; these are treated by a method, so far as I know, entirely my own. The flower before being treated was quite opaque, the treatment not only preserves the object but makes it transparent, so that all parts of interest can be examined under the Microscope. This is also a fine subject for dark-ground illumination."

In a further letter Mr. Allan says: "I am also forwarding one slide of *Trochodota* eggs mounted in fluid; this mount is for the Society's cabinet and will complete the set. The third slide in the parcel is a mount of *Gorgonia* spicules with sample of *Gorgonia* as found. I have a fairly large collection of *Gorgonias*, but none like this, which is entirely different from any I have seen, and I would be much obliged if you can have it identified for me. You will notice the peculiar character of this variety from the sample enclosed. It grows in large sheets, covering everything in its course. I found it on an old pile of a jetty in Cario Bay. I have only found it in this one place, and so far I have not met anyone who has seen this variety, and therefore I would be much obliged if you would kindly make enquiry at your Meeting and inform me of the result. Should it happen that it is a rare or new variety I would be pleased if your Society will accept the mounts as a contribution to their Collection. Will you please tell Professor Thomson I am preparing three mounts of *Trochodota*, plates and spicules, one for himself, and one each for Professor R. Koehler and Professor C. Vaney, which I will forward as soon as I hear of the safe arrival of the last parcel I sent."

Mr. Rousselet read descriptions of (1) some slides which had been sent to the Society by Mr. Gooding ; and of (2) three old Microscopes presented as donations to the Society.

The President expressed the thanks of the Society for the valuable gifts just described by Mr. Rousselet. He would like especially to call attention to the slides sent from Australia by Mr. Allan, who deserved every encouragement on the part of the Society. The slides of *Trochodota dunedinensis* were of great interest, as Professors Koehler and Vaney, two of the leading authorities on Holothurians, had admitted. The Society should thank and encourage a worker whose material was of much interest and beautifully prepared.

Dr. Hebb read a description of Grayson's Rulings, sent for exhibition by Mr. Merlin.

Three prints of Mr. Grayson's rulings were exhibited ; these showed the 100,000, 110,000, and 120,000 rulings of his 12-band plate. The special interest in these photographs is that previously nothing over 112,595 lines to the inch has ever been exhibited. The prints were accompanied by encomia from Mr. E. M. Nelson and Mr. A. A. C. E. Merlin.

The thanks of the Society were accorded to Mr. Merlin for his exhibit.

Dr. Butcher, describing a series of exhibits of photomicrographs of diatoms, said :—"Certain difficulties that I have met with in the course of a study of the various theories advanced in support of the generally accepted conception of what constitutes the microscopic image both in regard to form and colour, led me to attempt to determine for myself some of the physical elements that were possibly at the root of my mental unrest and incertitude. To this end, amongst objects selected for examination, the group of diatoms as used for test objects naturally presented itself for investigation. But soon, in order to divest myself of prejudices which might have been acquired during years of work, I broke away from the beaten track, worn by the authors and the scientific opticians, and selected other forms—already described, it is true, but usually only from the point of view of classification or life-history. Two, however—*Coscinodiscus asteromphalus* and *Navicula Smithii*—have been studied on structural or optical grounds by Mr. E. M. Nelson and Dr. Spitta respectively. As I have been unaware of their labours until some three months ago, the microscopic photographs I present may be taken as an independent confirmation or refutation of the description of their physical characters put forward by the two observers named. I therefore only place them in this preliminary note for that purpose.

"*Coscinodiscus asteromphalus*. The specimens of this diatom were obtained from Mr. William Firth, of Belfast, and I here acknowledge to the full that any success I have obtained in the clearness of my results is greatly due to his superb skill as a mounter. The appearances portrayed came up with comfort and ease in comparison with the difficulties presented by many of my other specimens from other sources. To confirm the results I have also worked at *C. omphalanthus* under exactly similar photographic conditions, and with very similar results.

The negatives were obtained in series representing successive planes or foci of the object, and these in particular, as also those of *Navicula Smithii* mentioned later, were exposed to direct light only; no oblique light, screens, intensification or reduction, or any mechanical process of photographic manipulation whatever, being allowed to come into play to produce what I thought might make a good picture; and, 'en parenthèse,' I may here say that the exasperating character of the illusion produced and the false images obtained by the use of oblique light have rendered many of my negatives apparently useless, except from the standpoint of seeing what an observer can do with an oblique pencil of light faultily illuminating a partially opaque object with irregular surfaces.

Navicula Smithii has been very useful to me in my studies, and I have observed it under many conditions. I have not seen it look like the illustration in Dr. Spitta's book, 'Microscopy,' where, however, it figures mostly as an example of the performance of a modern lens. My photographs, on the other hand, revealing minute detail, are representations of the appearances displayed by all of the specimens in my possession, and though not germane to my investigation, are shown now because they may be of interest to the biologist. I refer particularly to the structure of the raphe, the central nodule, and the hyaline area. Here also I take the opportunity of bringing forward photographs illustrative of an unnamed specimen found by Mr. Firth in some material from Oamaru, which display features either new or strikingly abnormal, and I append micrographs of the raphe of *Pinnularia cardinalis* and the basal structure of *Triceratium fuvus*, as being good and instructive illustrations of their several characteristics.

"*Conditions*.—Illuminant, electric arc: alternating current 220 volts; periodicity 83, with suitable resistance and transformer; average use = 18 amperes 36 volts; carbons cored 9 mm.; candle power 1000 (estimated). Auxiliary condenser. 'Substage condenser, oil-immersion N.A. 1.40. Objective, 2 mm. apochromatic homogeneous oil-immersion N.A. 1.40. Compensating ocular \times 18. Tube length, 160 mm. Camera length, 250 mm. Backed plate, speed 225 (H. and D.). No screens. Direct light. Exposure, 18 seconds. Developer, metol-hydrokinone."

The President said the Society was greatly indebted to Dr. Butcher for the exhibit of photomicrographs. He felt sure that Dr. Butcher, who had been working away independently, in the scanty leisure of a busy practitioner's life, would welcome criticism or appreciation from any one who understood microphotography and diatoms.

Mr. A. E. Hilton said, in reference to his exhibit, the place in nature of Mycetozoa, so far as it can be determined, is indicated, at the present time, by a disposition to classify them along with Rhizopoda, which are but one remove from Monera, the lowest forms of animal life. The metamorphoses of Mycetozoa, however, mark them off as an entirely distinct group. Their life-history presents three principal phases; these, in their natural order, being aquatic, amœboid, and aerial.

In the aquatic stage, highly microscopical and free-swimming swarm-spores, each having a nucleus and flagellum, multiply by repeated

divisions, and finally fuse together, forming an amœboid jelly-mass or plasmodium.

Usually, the amœboid stage is aquatic only at the outset. The plasmodia, often so small as to be scarcely perceptible, attain in some species dimensions of several inches. They spread over decomposing vegetable substances, on which they feed, and so increase in bulk. The veins of their fan-like and net-work extensions exhibit reversing currents of the interior plasm. These currents, or streamings, are caused by pressure and suction, probably originating in rhythmic dilatations and contractions of slow respiration. Apparently the functional energy by which the plasmodia breathe is thus converted into the flowing impulses by which they move. After a while, they creep from damp to drier spots, and gather up for spore-formation. For this purpose, plasmodia occupying the interstices of rotting wood come to the surface.

The aerial, or dry phase, is a process of rejuvenation by purification. The congested plasm relieves itself by excreting its undigested contents, and the rejected substances are deposited in various forms of hypothallus, stalks, columellæ, sporangia walls, capillitia, or spore-cases. The secretion of the spore-cases by the plasm is the last act of purification. Practically the whole of the plasmodium breaks up into spores, and the spherical shape and uniform size of the spores in each species is a striking geometrical expression of the balanced condition of the purified plasm, governed by energies radiating from nuclear centres, which are equally distributed throughout the mass. The life-cycle recommences with the emergence of the swarm-spores into water, after the fine, dry powdery spores have been liberated from the sporangia, by wind, rain, or other means.

The entire life-history is thus essentially a series of alternating phases, in which numbers of plasm-specks (swarm-spores) blend into a larger jelly-mass (plasmodium), which breaks up into multitudinous spores, and so on, endlessly.

The question of the sexuality of Mycetozoa is a very obscure one. In all three phases there are nuclear divisions, and in the maturer stages the nuclei multiply greatly; but there also appear to be nuclear fusions, followed by reduction divisions, especially in the stage immediately prior to formation of spores. Whether such fusions are sexual is by no means clear.

The specimens under the Microscopes are all British, and illustrate only the aerial phase of the life-history. In most instances the sporangia are intact, and contain spores. In regard to the other specimens, it must be remembered that, as the spores have been dispersed, the structure which remains, however curious or beautiful, is but the lifeless memorial of biological processes, which have passed on to repeat themselves in a new generation.

The President said they would look forward to examining Mr. Hilton's slides of these very primitive organisms, which were in many ways peculiarly fascinating. He had always thought that the formation of the plasmodium was in itself a rudimentary sexual process.

The thanks of the Society were voted to Mr. Hilton for his interesting exhibit and communication.

Mr. Herbert F. Angus, of the firm of H. F. Angus and Co., exhibited and described a number of Microscopes by R. Winkel, of Göttingen, who, he said, enjoyed a high reputation in Germany, although almost unknown in England. He pointed out that the model was of the more or less stereotyped Continental pattern, inclining more to the Zeiss model than any other, but differing in several important details, as was only to be expected in the productions of an old-established firm who had given proof of their originality in the past by first employing fluorite in the construction of objectives, and producing an objective with a hyper-hemispherical front lens. At the present day, however, they would base their claim to notice rather on the quality than the novelty of their production, and of that quality, both mechanical and optical, the Fellows would have an opportunity of judging that evening, as besides the instruments set up with test objects, a number of their stands with low-power objectives had been included among those of Swift, Leitz, and Reichert, which his firm had had the pleasure of loaning for Mr. Hilton's use that evening.

The President said that he felt a peculiar interest in this exhibit of Microscopes, since about thirty years ago he had bought his first Microscope, which was one made by Winkel.

The thanks of the Society were accorded to Mr. Angus for his exhibit, and also for the loan of Microscopes to illustrate Mr. Hilton's exhibits.

The President made a communication on Japanese Pennatulids, and exhibited some typical specimens of great beauty. He said that he had been entrusted by Professor Ijima, of Tokyo University, with a collection of Pennatulids, on the study of which he was at present engaged. His report was not yet ready for publication, but he had thought that it would be of interest to the Fellows of the Society to see a representative sample of these beautiful Sea-Pens. They would understand when they looked at the dimensions of the specimens, why it was necessary on a long railway journey to be content with a sample of the collection.

The Pennatulacea, or Stelechotokea, include some of the most beautiful of fixed marine animals—long graceful colonies, often plume-like, as their name suggests, with rich colouring, and with strong luminescence. They live fixed on the floor of the sea, and many of them show a familiar adaptation to life on the bottom—long stalks raising the polyp-bearing portion off the substratum. In deep-water forms, such as the beautiful Umbellulas, the proportion of sterile stalk to polyp-bearing rachis reaches an extreme.

The Pennatulids were related to Alcyonarians, such as Dead Men's Fingers, Precious Coral, Organ-Pipe Coral, the Gorgonids, and the Gorgonellids, like *Hicksonella*, which Mr. Simpson had established as a new genus at the last Meeting of the Society. They differed markedly, however, in several respects. In a very remarkable way, the primary polyp which developed from the fertilized egg-cell was sacrificed to forming the main axis on which the secondary polyps were borne, which in turn might give off (always through the intermediation of stolons or solenia) tertiary polyps, and so on. A central rod, which was present in

the majority as the skeletal support of the colony, ran up the middle of the gastric cavity of the primary polyp, and some authorities regarded it, therefore, as endodermic in origin, whereas the skeletal support of all related forms is ectodermic. Thirdly, the Pennatulids almost always showed a pronounced dimorphism—along with the ordinary polyps or autozooids there were dwarf polyps without tentacles, the siphonozooids, whose office it was to keep currents of water going in the canals of the colony. It should also be noted that there was in Pennatulacea a marked tendency to bilateral arrangement of the polyps, similar to the arrangement of barbs on a feather.

The President first exhibited a specimen of *Anthoptilum thomsoni*, which Kölliker had named after Wyville Thomson. It was nearly 100 cm. in length, the rachis amounting to 83 cm. With its long purplish-brown polyps and almost massive bulk it presented a very handsome appearance. In this genus there are no pinnules, the autozooids arising in numerous short rows on the substantial rachis. The polyps are large and without calices; the siphonozooids are small and very numerous; there are no spicules except in the lowest part of the stalk. The specimen exhibited agrees with the description of *A. thomsoni* given in the 'Challenger' Report, except that no spicules could be found at the base of the stalk.

The second specimen shown was the well-known *Funiculina quadrangularis* Pallas, a primitive Pennatulid with toothed calices seated directly on the axis, and without true siphonozooids. It is interesting also in its very wide geographical distribution, for it is very common off the West coast of Scotland, and it extends from shallow water to the great abysses.

The third specimen shown was *Pennatula murrayi* Kölliker, a delicate and graceful species named after Sir John Murray. One of its features is the presence of a very large siphonozooid at the base of each pinnule. It belongs to a section of the genus characterized by having the dorsal side of the rachis almost free from siphonozooids. Related to *Pennatula* is the genus *Scytalium*, which has not distinct calices for the polyps on the margins of the pinnules. Two species were shown, the gorgeous *Scytalium splendens* Thomson and Henderson, with brilliant red and orange-yellow, over 46 cm. in length, and the very striking pale blue *S. tentaculatum* Kölliker, 115 cm. in length, with about 170 pairs of pinnules.

The interest of the collection lay chiefly in the fineness of the specimens, the occurrence of some rare forms like Hubrecht's *Echinoptilum macintoshi*, and the number of species common to Japanese seas and those round our own coasts.

The President also read two papers by Dr. Gemmill—(1) "Aerator for Small Aquaria"; (2) "Adaptation of Ordinary Paraffin Baths for Vacuum Embedding."

Mr. Heron-Allen proposed a very hearty vote of thanks to the President for his paper on Sea-Pens, and for reading Dr. Gemmill's two communications. He felt that the task of proposing this vote might have been in the hands of someone more fully equipped than he was for

the purpose, but he could at any rate voice the sentiments of the Society when he expressed his very great gratitude to Professor Thomson for taking the trouble to bring up the beautiful specimens exhibited—in itself a Herculean task—and for showing the lovely drawings, without which those who understood but little of this particular branch of biology would have had some difficulty in following. The question of the paraffin bath he would prefer to leave severely alone, as he had not the faintest idea for what it would be used. The aerator, however, seemed to be a very wonderful apparatus, and for those who could not aerate their own aquaria (as he thought the majority did by oxygenating the water with green algæ), it would be a god-send. He was bound, however, to confess that he regarded with a somewhat jaundiced eye an apparatus which could produce minor species in a finger bath. He might have misunderstood the President when he said that the inventor of this apparatus had added three new species to the particular fauna found on the Clyde by means of this aerator, but he could not help recalling to his mind the communication made by himself and Mr. Earland at the last meeting of the Society, when he pointed out that three varieties of a species of foram had been successfully born in their aquarium, in consequence, as they thought, of the starved condition in which they were kept. He therefore looked to Professor Thomson to make clear to them whether the new species mentioned by Dr. Gemmill were really new species or varieties, or whether they were unfortunate abortions as the result of living in the company of an apparatus of the character described.

The President said that for the sake of Dr. Gemmill's reputation he would hasten to say (if he might do Mr. Heron Allen the injustice of taking him seriously) that what Dr. Gemmill did was to establish from among the animals in his aerated tanks three new records for the Clyde.

The vote of thanks to the President proposed by Mr. Heron-Allen was carried unanimously, and a hearty vote of thanks accorded to Dr. Gemmill for his communications.

A paper was read by Mr. Barnard, "On the Use of a Metallic Electric Arc in Photomicrography."

Mr. Rheinberg said that he would like to ask Mr. Barnard in connexion with this interesting method whether he could state approximately the relative luminosity of the cadmium-silver arc as compared with the ordinary carbon arc light using the same amount of current.

Mr. Barnard replied that in the case of the cadmium-silver arc the light-energy is concentrated in certain bright lines, and in the region of these lines the luminosity was much greater than in a carbon arc.

Mr. Rheinberg said he was speaking from the point of view of length of exposure.

Mr. Barnard replied that the exposure would be less with the cadmium-silver arc, assuming that exactly the same regions of the spectrum were used for comparison.

Mr. Maurice Blood asked if it would be possible to use a carbon arc with a metallic core?

Mr. Barnard replied: No. With a metal like cadmium the whole of

the core melted and dropped out almost at once. The best experimental result he had obtained was by using thin silver tubes and filling them with cadmium. The silver and cadmium formed an alloy of higher melting point in the arc, but sooner or later a stage was reached, which was dependent on the current density, when the whole of the cadmium melted and ran out. Another objection to the use of a carbon electrode with a metallic core was that the continuous spectrum of carbon obtruded itself on the line spectrum of the metal, and so the whole object of the arrangement was lost.

Mr. Barnard read a paper on "A Simple Method of obtaining Instantaneous Photomicrographs."

Mr. Earland asked whether the method could be used in photographing opaque objects?

Mr. Barnard replied that it could quite well. Provided the light was sufficiently powerful there was no limit to the application of the method in the direction indicated.

The thanks of the Meeting were accorded to Mr. Barnard for his interesting communications.

It was announced that the next Meeting of the Society would take place on December 21.

The following Instruments, Objects, etc., were exhibited:—

The Society:—Slide of *Navicula lyra*, abnormal form, sent for exhibition by Mr. Walter Bagshaw; two Spread Slides of Diatoms containing *Pleurosigma* sp., presented by the Hon. T. Kirkman.

The following Slides, presented by Mr. M. J. Allan: *Bryum* sp., mounted in fluid; *Bugula dentata*, showing polyps; *Gorgonia* sp., spicules; Marine Algæ with Diatoms in situ, mounted in fluid; *Stellaria media*, flower, mounted in fluid; *Trochodota dunedinensis*, eggs; *Tubularia larynx*, showing young Medusæ; Young Orange, transverse section of stem, double staining.

Microscope by Oberhauser and Hartnack, presented by Mrs. Wesché; Old Ivory "Sliders" containing objects, and a "Slider" containing magnifiers in a brass holder, presented by Mr. H. C. Gooding; Old Pocket Magnifiers in brass box, presented by Mr. Chas. Lees Curties.

The President:—Drawings and preserved Specimens of Japanese Sea-Pens; Diagrams illustrating Dr. Gemmill's papers.

Mr. A. E. Hilton:—The following Mounted Specimens of British Mycetozoa: *Arcyria albidu*, Sporangia on rotten wood, Spores partially dispersed; *A. ferruginea*, showing masses of Capillitia and the stalked membranous cups, from which they have broken away; *A. flava*, Expanded Capillitia, after dispersion of Spores; *A. punicea*, Sporangia after dispersion of Spores; *Badhamia foliicola*, Sporangia formed by revived sclerotium; *Chondrioderma spumarioides*, Sporangia on leaf; *Dictydixethalium plumbeum*, Æthalium on rotten wood; *Didymium*

effusum, Sporangia on ivy leaf, showing circular hypothallus at the base of each stalk; *D. farinaceum* var. *minus*, Sporangia on dead leaf; *Lamproderma arcyrioides*, Sporangia on sandy soil, among moss; *L. irideum*, Sporangia on withered leaf; *L. violaceum* (?), sporangia on withered grass; *Leocarpus vernicosus*, Sporangia on twig; *Spumaria alba*. Æthelium on withered grass (the lobed and convoluted spore-masses are covered with a thick crust of calcium carbonate); *Stemonites ferruginea*, Sporangia on rotten wood; *Trichia fallax*, Sporangia on rotten wood, before the dispersion of spores.

New Fellows.—The following were elected *Ordinary* Fellows of the Society:—Thomas William Butcher, Arthur Earland, Lilian Suzette Gibbs, Douglas Wilshin Murch, Herbert George Robins, Percy Parnaby Wilding.

INDEX.

A

- Abbe's Drawing Apparatus, Measuring Inclination of, 761
- Abel, O., Attitude of Dinosaurs, 23
— What is a Monstrosity, 712
- Abel, W., Development of Autonomic Nervous Mechanism of Birds' Alimentary Canal, 294
- Staining Embryonic Nerve-tissues, 382
- Abranowicz, E., Chloroplast-movements, 184
- Acera, Adaptive Structure, 713
- Achard, C., Leuco-reaction in Pregnancy, 296
- Achlya, Formation of Oogonia, 741
- Acinetæ Embryo, Symmetry, 40
— Hypertrophied, 40
- Acmea, Early Stage, 451
- Acoclea and Marsupella, 607
- Acorn-shells, Alleged Mimicry, 720
- Actinians, Studies, 322
- Actinomyces hominis* and *Streptothrix pyogenes*, Comparative Study, 222
— of the Cornea, 86
- Acton, E., *Coccomyza subellipsoidea*, a New Member of the Palmellaceæ, 61
— Primitive Lichens, 219
- Adams, J., Catalogue of Irish Fungi, 629
— and another, Irish Algæ, 620
- Address to H.M. King George V., 398
— to H.M. Queen Alexandra, 399
- Æcidium, Development, 627
- Æginetia, Studies, 45
- Æolididæ, New Family, 26
- Aerating Apparatus, Automatic, suitable for Aquaria, etc., 9, 127
- Aerator for Small Aquaria, 805
- Agama, Coccidian in Bile-ducts, 328
- Agar, W. E., Embryonic Appendage of Claws of Amniota, 149
— Nesting Habits of *Phyllomedusa savagii*, 448
- Agaricaceæ, British, Key, 749
- Agassiz, A., Teeth and a Lantern in Echinoneus, 37
- Agassiz, Prof., Death of, 399
- Agelastica alni*, Development, 308
- Agelena labyrinthica*, Development, 168
- Aglaophenia, Differentiation and Growth, 463
- Aglaozonia and Cutleria, Cytology, 69
- Air-chambers in Ricciaceæ, Development, 340
- Akatsuka, K., Asexual Mode of Auxospore Formation, 615
- Åkerman, Å., Chemotaxis of Spermatozoids in Marchantia, 193
- Albinism, 23
- Albugo candida* and *Peronospora Ficariæ*, Cytology, 622
- Albuminoid Reserves in Annelids, 169
- Albumins, New Colour Reaction, 522
- Aleiopa cantrainii*, Eye, 35
- Alecock, A., Indian Fresh-water Crabs, 575
- Aleyonaria, Indian Ocean, 584
- Aleyonarians collected by Sir Ernest Shackleton's Antarctic Expedition, 533
— Indian Ocean, 177
— Living, Observations, 177
— of Irish Coasts, 177
- Alessandrini, G., Piophila Larvæ in Cheese, 571
- Alexandrowicz, J.S., Sympathetic Nervous System of Crustacea, 573
- Alexieff, A., Transition Types between Bodo and Trypanoplasma, 181
— Trichomonad with Four Anterior Flagella, 325
- Alezais, —, Nucleated Red Blood Corpuscles in Blood-vessels of the Hypophysis, 707
— Process of Secretion in Human Hypophysis, 709
- Alga, Parasitic, New, 742
- Algæ and Sponges, Symbiosis, 480
— Black Sea, 621
— British, 346
— Finland, 72
— Fixation by means of Quinone, 521
— Fixing, 614
— Fossil, 204, 481
— Fresh-water, from Malay Region, 66
— — from Ruwenzori, 64
— — Greenland,
— — in Nature, 199
— — of Dutch New Guinea, 741
— — of Fiji, 66

- Algæ, Fresh-water, Russian, 621
 — — Sheath and Mucilage, 740
 — Fungus parasites, 73
 — Green, Phylogeny and Inter-relationship, 742
 — Hints on Collecting and Growing, 198
 — Irish, 620
 — Italian, 346
 — Japanese, 199, 346, 622
 — Marine, and Currents, 198
 — — British, 199
 — — from North-East Greenland, 478
 — — of Dominica, 199
 — — of Panama, 346
 — — West Indian, 346
 — Naturalisation, 198
 — of Auckland and Chatham Islands, 744
 — of Brandenburg, 620
 — of Haute-Savoie, 203
 — of Panama, 620
 — of Suffolk and Norfolk, 65
 — of the Tatra Mountains, 621
 — of Trebizond, 621
 — Periodicity, 65
 — Polymorphism, 349
 — Sexual Reproduction, 740
 — See CONTENTS
 Algological Prophecy Fulfilled, 63
 Alimentary Canal, Birds', Development of
 Autonomic Nervous Mechanism, 294
 — in Lepidosiren and Protopterus,
 Development, 295
 — Tract and Habits of *Simulium colum-
 bacensis*, 306
 — of Lynceus, 456
 Allan, M. J., Gorgonia, unknown Species,
 800
 — Moss and other Objects mounted in
 Fluid, 800
 — Photomicrographs of arranged Diatoms,
 125
 — *Trochodota dunedinensis*, 532
 — Variable Eye-piece, 800
 Allen, E. J., Artificial Culture of Marine
 Plankton Organisms, 374
 — Rearing Marine Larvæ, 563
 Alligator, American, Brain, 561
 Allis, E. P., Cranial Anatomy of Mail-
 checked Fishes, 160
 Allocreadium, Genus, 581
 Alloys, Aluminium-copper-tin, 675
 — Aluminium-zinc, 675
 — and Metals, Shrinkage, 388
 — — — Solubility of Gases, 530
 — Cobalt-gold, 525
 — Composition of Mixed Crystals, 392
 — Copper-aluminium, 387
 — Copper-aluminium-manganese, 789
 — Copper-arsenic, 676
 — Copper-tin, 119
 — Copper-zinc, 675
 — Formation by Pressure, 528
 — free from Solid Solutions, Resistance, 793
 Alloys, Iron, 120
 — Iron-carbon, 390
 — — Effect of Low Temperature, 791
 — Iron-copper, 120
 — Iron-manganese, 120
 — Lead and Tin, 119
 — Lead-tin, 525
 — Light, 677
 — Metallic, Specific Heat, 528
 — — Thermo-electric Properties, 529
 — Nickel-carbon, 525
 — Novel Application, 530
 — of Cobalt, 388
 — of Ferro-magnetic Metals, Magnetic
 Properties, 264
 — of Iron, 262
 — — — Magnetic Properties, 391
 — of Lead with Indium and Thallium, 261
 — of Nickel and Copper, 387
 — of Silver with Zinc, 260
 — of Tin and Lead, 260
 — Physical Properties, 260
 — Rate of Change, 123
 — Silver Coinage, 119
 — Stamped, and Bearing-metals, 789
 — Thermo-electric Properties, 529
 — Thermo-electricity, 677
 — Titanium, Application in the Steel
 Industry, 792
 — Zinc, 260
 Aloes, Classification by Leaf-structure, 331
 Alpheidæ, New, 718
 Alten, H. v., Callus-formations in Nuphar,
 466
 — Studies on Roots, 45
 Altmann's and Flemming's Granules,
 Identity, 671
 Aluminium-copper-tin Alloys, 675
 Aluminium-copper-tin System, 119
 Aluminium-zinc Alloys, 675
Alytes obstetricans, Spermatogenesis, 152
 Amakebe and East Coast Fever, 326
 Amalgams, Zinc, 676
 Amanita, Influence of Gravity on Growth,
 334
 Amblystegium, North American Species,
 58
 Ambrosia Fungi, 492, 629
 Ammann, J., Swiss Tardigrada, 33
 Ammocetes, Mesencephalic Nerve, 161
 Amniota, Embryonic Appendage of Claws,
 149
 Amoeba, New, in Man, 40
 — — parasitic, in Man, 40
 — Nucleus, 728
 — parasitic, New, 327
 — Studies, 589
 Amphibia, Studying the Morphology of
 the Blood, 383
 Amphibians and Reptiles of Jamaica, 448
 — Blood, 446
 — Reactions to Light, 559
 — Toxic Action of Mucus, 448

- Amphidiscophora, Phylogeny, 39
 Amphioxus, Development of Nephridium, 443
 — Studying the Development, 115
 Amphipods, Australian, 718
 — from North Side of Bay of Biscay, 574
 — New, from Eastern Tropical Pacific, 34
 Anaerobic Apparatus, New, 520
 — Methods, Simple, 374, 660
 — Streptococcus, New, 364
 Anastrophyllum, New Species, 342
 Anatomy of Seed Plants. *See* CONTENTS
 Ancel, P., Ovarian Glands, 17
 Anderson, J. A., Glass and Metallic Replicas of Gratings, 763
 — Method for Testing Screws, 767
 André, E., New Parasites of Dendrocoelum, 41
 — Parasitic and Commensal Marine Infusorians, 325
 André, J., Eyes of *Polystomum integerrimum*, 582
 — Nervous System of *Polystomum integerrimum*, 582
 Andrew, J. H., Aluminium-copper-tin Alloys, 675
 — Aluminium-copper-tin System, 119
 Andrews, A. le Roy, Nomenclature of Sphagnum, 193
 Andrews, C. W., Habits of Robber Crabs, 455
 Androgynous Receptacles in Marchantia, 472
 Aneimia and Lygodium, Prothallia, 337
 Anemones, Nervous System, 176
 Angioperis and Kaulfussia, Development, 594
 Angus, H. F., Microscopes by Winkel, 804
 Animals, Fresh-water, Capillary Phenomena in Life of, 24
 — Marine, Use of Magnesium in Stupefying, 246
 Anitschow, N., Mounting Frozen Sections, 787
 — — Serial Celloidin Sections, 787
 Annandale, N., Fresh-water Sponges from the Philippines and Australia, 587
 — Living Species of Diplonema, 306
 Annelid Fossil Burrows, 315
 Annelids, Albuminoid Reserves, 169
 — Marine, of Dublin Bay, 721
 Annulata. *See* CONTENTS
 Anomura of Kattiawar, 168
 Anoplophrya, Conjugation, 179
 Anschütz, G., *Hæmoproteus orizivoræ*, 39
 — Studies on Trypanosomes, 465
 Ant, Mosquito Fed by, 570
 Ant-Bear, Organ of Jacobson, 158
 Antennary Gland, Rudimentary, in Cladocera, 34
 Antheridia, Imbedded, in Dryopteris and Nephrodium, 50
 Antimony and Tin, Influence on the Iron-carbon System, 679
 Antipatharian, Rare and Remarkable, Note on *Dendrobrachia fallax* Brook, 142
 Antipatharians from the Indian Ocean, 269, 273
Antirrhinum majus, Inheritance of Flower-colour, 336
 Ants and Plants, 452
 — Nests, 305
 — Seed-gathering, 304
 Aortic Ligament of Shad, 159
 Aphides, Studies, 167
 Aplanatic or Cardioid Condenser for Dark-ground Illumination, 515
Aplysia punctata, Studying the Development, 774
 Apogamy and Apospory in Trichomanes, 187, 734
 — Hybridisation, and Heredity in certain Ferns, 470
 — in *Pteris droogmantiana*, 470
 Apospory and Apogamy in Trichomanes, 187, 734
 — and Sexuality in the Mosses, 340
 Apples, Endomyces, 745
 — Mildew, 746
 Aquaria, etc., Automatic Aerating Apparatus suitable for, 9
 Arachnida. *See* CONTENTS
 Arachnologia, Fragmenta, 310
 Araneæ, Phylogeny of Tracheæ, 311
 Arc, Metallic Electric, Use in Photomicrography, 806
 Archegonium and Calyptra, Biology, 54
 — Phylogeny, 735
 Archer, J., Hepatics and Contamination, 614
 Arenicola, Disease, 35
 — Species in Paris Museum, 579
 Aricia, Artificial Parthenogenesis, 35
Arion empiricorum, Polar Bodies, 26
Armillaria mucida, 485
 Armitage, E., Hepaticæ of Madeira, 476
 — New Records of British Sphagna, 475
 Arnaud, G., Study of Fumagine Fungi, 750
 Arndt, G., Automatic Fixing and Imbedding Apparatus, 774
 Arnemann, P. T., Metallography of Zinc, 788
 Arnold, J., Glycogen of Muscle, 446
 Arnold, W., New Colour Reaction for certain Albumins, 522
 Arnoldi, W., Germination of *Salvinia natans*, 51
 Arnou, G., Metallography in German and Belgian Laboratories, 792
 Arsenic and Tin, Influence upon Iron, 262
 Arthropoda. *See* CONTENTS
 Arthropods, Muscle-insertions, 164
 Arthrostraca, Coagulation of Blood, 574

- Arthur, J. C., and others, Uredinææ. 76
 Arts. L. J., Musculature of Hirudinea, 35
 Arzt, L., *Streptococcus mucosus*, 501
 Ascarids, Fibrillar Structures in Muscles and Intestinal Cells, 170
Ascaris mystax in Lion, 36
 — Nervous system, 170
 Ascidian, New Copepod from, 169
 Ascidians, Crustaceans living in, 314
 Ascid, Cytology, 74
 Ashe, A., Old Microscope presented by, 642
 Ashworth, J. H., Giant Nerve-cells and Fibres of Halla, 457
 — Medusoids, Medusæ, and Ctenophores of Firth of Forth, 176
 — Species of *Arenicola* in Paris Museum, 579
Aspergillus glaucus, 206
Asphodelus microcarpus, Chromosomes, 182
Aspidium remotum, 190
Asplenium Lingelsheimi, a New Hybrid, 601
 Asses, Domestic, Agriotype, 158
 Asteroids and Echinoids from Mergui and Burma, 321
 — from Portuguese East Africa, 321
 — Indian Ocean Shallow-water, 584
 — New Order, 726
 Aston, J., Influence of Arsenic and Tin upon Iron, 262
 — Iron Alloys, 120
 — Iron-copper Alloys, 120
 — Iron-manganese Alloys, 120
 — Magnetic Properties of Alloys of Iron, 391
 — — — of Iron and Alloys, 526
 Astorri, L., Cementation of Steel, 527
Astrocladium cerastioides, 202
 Astrosclera, Nature, 728
 — *willejana*, Affinities, 324
Asymmetron bassanum Gunther, 25
 Athanasiu, J., Seasonal Migration of Fat in the Frog, 24
 Atkins, W. R. G., Osmotic Pressure in Plants, 593
 Atkinson, G. F., Evolution of the Lower Fungi, 72
 — Fungus Parasites of Algæ, 73
 — and others, Notes on the Larger Fungi, 77
 Atractis, New Species, 458
 Atyidæ, Phylogeny, 33
 Audigé, J., Injecting Kidney of Teleostean Fish, 378
 — Kidney of Teleosteans, 449
 Auditory Ossicles in Horse, Development, 150
 Aurides of Magnesium, 261
 Austen, E. E., New *Cordylobia*, 716
 Austin, C. F., North American Bryologist, 195
 Auxospore Formation, Asexual Mode, 615
 Avery, O. T., Observations on certain Lactic Acid Bacteria of the so-called Bulgarian type, 89
 Axolotl, Palatine and Pterygoid Bones, 301
 — Transformation of Palatal Region, 301
 Azalea, Exobasidium, 77
 Azobacter, Two New Methods for Growing in large quantities for Chemical Analysis, 109
 Azur-eosin Method, Staining Moist Preparations and Sections, 522
- B
- Babes, V., Metachromatic Granules in Acid-fast Bacilli, 497
 — New Variety of Mycosis occurring in Man, 637
 Baccarini, P., Development of *Lasiopodia Fiorii*, 351
 Bacillariaceæ from Nyassa Land, 616
 Bacilli, Acid-fast, Metachromatic Granules, 497
 — Thermophilic, New Species, 500
 — Tubercle, Acid-fast and Granular Types, 500
 — — Detection in Milk and Fæces, 782
 — — Different Methods of Staining, 258
Bacillus arenicolæ, 86
 — *bulgaricus* vel *B. lactis acidi*, 361
 — — and *Bacillus diphtheriæ*. Antagonism, 364
 — *coli* and *Bacillus typhosus*, Differential Diagnosis by means of coloured Cultivation Media, 521
 — *diphtheriæ* and *Bacillus bulgaricus*, Antagonism, 364
 — *lactis acidi* vel *B. bulgaricus*, 361
 — Leprosy, Cultivation, 521
 — *moniliformis*, 361
 — New in Cheese, 221
 — — of Fowl-septicæmia, 364
 — — of the Hæmorrhagic Septicæmia Group, 497
 — of Typhus Fever, 638
 — *paratyphosus* and *Bacillus typhosus*, Morphological Differentiation, 363
 — *perfringens*, Spores, 223
 — *septicæmiæ anserum exsudativæ*, 90
 — *tuberculosis*, Cultivating, 521
 — *typhosus* and *Bacillus coli*, Differential Diagnosis by means of Coloured Cultivation Media, 521
 — — and *Bacillus paratyphosus*, Morphological Differentiation, 363
 — — Modification of the Conradi Medium for Isolating, 112
 Backhoff, P., Development of the Dragonfly, 568
 Backmann, A., Involution of Thymus in Rabbit, 150

- Bacteria, Acid-fast, New Method of Demonstrating the Spores, 116
 — Appearance found when Examined by the Indian-ink Method, 635
 — Detection by means of an Electric Current, 110
 — in Soil, Media for Enumeration, 362
 — Lactic Acid, of the so-called Bulgarian type, Observations, 89
 — Presence in Echinococci and Cysticerci, 88
 — Slime, on Sponges, 757
 — Soil, Quantitative Estimation, 362
 — various, Resistance to Alterations in Osmotic Pressure, 222
- Bacteriaceæ and Myxobacteriaceæ Comparative Studies, 88
- Bacterial Disease of Potatoes, 499
 — Disease, Relation of Entozoa to, 25
 — Flora in the Ice of Monte Rosa, 361
 — — of Rachitic Stools, 757
 — Parasites of Barley, 637
 — Rot in Turnips, 499
- Bactericidal Influence, Apparent, of Colostral Milk, 710
- Bacteriological and Chemical Study of Fresh Eggs, 635
- Bacteriology, Soil, Recent Researches, 758
- Bacterium anthroposepticum*, 637
- Bagnall, R. S., New Genera of Thysanoptera, 167
- Bailey, I. W., Wood Structure in Pineæ, 44
- Bainier, G., Study of Chætomium, 351
- Baker, F. C., Œcological Study of Meluluses, 451
- Baker, F. H., Exchange of Slides of Polyzoa, 272
- Baker, F. W. W., Exhibition of Slides illustrating the Structure and Development of the Eye, 130
- Baker, S. M., Zoning of Brown Seaweeds, 348
- Baker, T., Gases occluded in Steel, 124
- Balance Sheet, 133
- Balantidium coli*, Pathogenic Role, 41
- Baldasseroni, V., Filariæ in Ixodes, 317
- Balfour-Browne, F., Life-history of Agrionid Dragon-fly, 166
- Ballenger, —, New Dahlia Stain, 786
- Balsaminæ, Study, 482
- Bambeke, C. v., Deformation of the Egg of *Mutinus caninus*, 78
- Bancroft, W. D., Aluminium-zinc Alloys, 675
- Banfield, A. C., Method of Preparing Stereo-photomicrographs, 233
- Banks, C. S., Polyscopic Cells, 673
- Banks, N., Catalogue of Nearctic Spiders, 454
 — Collecting and Preserving Insects, 112
- Barbour, T., Reptiles and Amphibians of Jamaica, 448
- Barfurth, D., Hyperdaetylim in Fowls, 20
- Barley, Bacterial Parasites, 637
- Barnacles, Association with Snakes and Worms, 721
 — New Fossil, 315
- Barnard, J. E., 271
 — A Simple Method of obtaining Instantaneous Photomicrographs, 807
 — On the Use of a Metallic Electric Arc in Photomicrography, 806
- Barnes, Charles Reid, 476
- Barnes, E. J., Chromium Steel, 790
- Barnes, J. M., 477
- Barns, C., Use of the Grating in Interferometry, 764
- Barré, M., Copper-aluminium Alloys, 387
- Barrett, W. F., Methods of Determining the Amount of Light Scattered from Rough Surfaces, 101
 — New Form of Polarimeter for the Measurement of the Refractive Index of Opaque Bodies, 93
- Bartetzko, H., Freezing of Filamentous Fungi, 79
- Bartlett, A. W., Two Diseases of Gooseberry Bushes, 488
- Barus, C., An Adjustment for the Plane Grating similar to Rowland's Method for the Concave Grating, 105
- Basidiomycetes, British, 750
- Bat, Polynuclear Ovum, 294
- Bataillon, E., Artificial Parthenogenesis of Frogs' Eggs, 706
- Bateman, H. R., Amakebe and East Coast Fever, 326
- Bather, F. A., Fossil Annelid Burrows, 315
- Bathie, H. P. de la, Clusiaceæ of Northwest Madagascar, 732
 — Fungi of Termites' Nests, 354
- Batrachians and Parthenogenetic Embryos, Number of Chromosomes, 706
- Batrachospermum, New, 743
- Battaglia, M., Study of Nagana Trypanosome, 464
- Baudran, —, Media which Attenuate or Exalt the Virulence of Tubercle Bacilli, 86
- Baumeister, L., Egg of Rhinophis, 294
- Baxter, W. E., 134
- Bearing-metals and Stamped Alloys, 789
- Beauchamp, P. de, Hæmocœle in Dinophilus, 460
 — *Hastatella radians*, 589
 — Parthenogenesis in *Dinophilus conklini*, 316
- Beauverie, J., Ambrosia Fungi, 492, 629
 — *Merulius lacrymans*, 353
- Becher, S., Systematic Position of *Rhabdomolgus Novæ-Zelandiæ*, 38
- Beck, C., 271
- Beck-Gordon Speculum Lamp, 92
- Becker, E., Post-antennary Organ of *Collembola*, 453

- Becker, H., Decarburisation of Cast Iron by Gaseous Oxidising Agents, 527
- Becker, R., Head and Mouth parts of Dip-terous Larvæ, 453
- Becquerel, P., Variation of Zinnia due to Traumatism, 185
- Vitality of Spores, 491
- Bee's, Worker, Mandible, Sensory Structures on, 714
- Beetle, Development of Mid-gut, 30
- Beetles, Cave, 452
- Chrysomelid, Effect of Centrifugal Force upon Eggs, 308
- Effect of Centrifugal Force on the Development, 715
- Tobacco, 165
- Beilby, G. T., Surface-flow in Calcite, 123
- Belaiew, N., Artificial Reproduction of Widmanstätten Figures, 791
- Bell, F. J., Indian Ocean Echinoderms, 461
- Belogolowy, J., Development of Cranial Nerves in Birds, 443
- Bembex nubilipennis*, Nesting Habits, 713
- Bemmelen, J. F. v., Rabbit and Hare, 710
- Benard, H., Leuco-reaction in Pregnancy, 296
- Benecke, W., Periodicity of Algæ, 65
- Beneden, E. van, Death of, 399
- Benedict, R. C., *Botrychium ternatum* and its Allies, 51
- Peculiar Habitat for Comptosorus, 338
- Relationships of the Genera of the Vittarieæ, 600
- Bengough, G. D., Copper-arsenic Alloys, 676
- Rate of Change in Alloys, 123
- Benham, W. B., New Zealand Echinoderms, 461
- Bennett, S. R., Ferro-silicon, 679
- Berg, W., Simple Method of Paraffin Im-bedding in Vacuo, 255
- Bergen, K., Different Methods of Staining Tubercle Bacilli, 258
- Bergold, A., Structure of Fresh-water Ostracods, 576
- Berjot, H., Hardness of Quenched Steels, 391
- Berlese, A., Monograph on Myrientomata, 33
- Berliner, K., Cutting thin Parallel Slices of Brain Substance, 253
- Improved Brain Microtome, 377
- Bernard, C., Fresh-water Algæ from the Malay Region, 66
- — of Dutch New Guinea, 741
- Bernard, P. N., Endotoxin of *Micrococcus melitensis*, 635
- Bernecker, A., Minute Structure of Respiratory Organs in Crustaceans, 33
- Bertarelli, E., Flies and Typhus Fever, 453
- — as Disseminators of Typhus, 716
- Bertarelli, E., Tuberculosis in Cold-blooded Animals, 501
- Bertrand, G., Resistance of Vegetable Tyrosinases to High Temperatures, 751
- Bessell, J. B., Devonshire Diatoms, 201
- Betegh, L. v., New Method of Demonstrating the Spores in Acid-fast Bacteria, 116
- Study of Sarcosporidia, 181
- Tuberculosis in Salt-water Fish, 497
- Bethe, A., Function of Neurofibrils, 709
- Betula, Species of Taphrina on, 75
- Bezzi, M., Empididæ, 306
- Bialosuknia, W., New Genus of Pleurococcaceæ, 202
- Bibliography, Botany, 72, 82-85, 90, 205, 216-218, 220, 223, 349, 358-60, 365, 493-6, 622, 631-634, 639, 753-756, 759
- Metallography, 124, 265, 531, 680, 795
- Microscopy, 92, 99, 101, 108, 113, 233, 253, 508, 517, 650, 655, 659, 663, 765, 766, 772, 782, 788
- Bidulphia sinensis*, 66
- — in the North Sea, 201
- Bielschowsky's Silver Method, Modification, 670
- Bierbaum, K., *Bacillus septicæmiæ anserum exsudative*, 90
- Bigeard, R., French Fungus Flora, 356
- Bilek, F., Fibrillar Structures and Muscle-cells and Intestinal Cells of Ascarids, 170
- Bilewsky, H., Red Yeast, 747
- Billard, A., Revision of British Museum Hydroids, 464
- Billard, G., Immunity of Lerot to Viper's Poison, 22, 710
- Biltz, W., Systems: Tin-sulphur, Tin-selenium, Tin-tellurium, 261
- Biological Station, Millport, Notes, 301
- Birds, Development of Cranial Nerves, 443
- — of Subdivisions of Pleuroperitoneal Cavity, 151
- North American, Tapeworms, 319
- of Greece, Malaria, 40
- of Illinois and Wisconsin, 300
- of New South Wales, Hæmoproteozoa, 40
- Peyer's Patches, 709
- Regeneration of Bone, 557
- Bishop, H. M., Gastropod Foot and Branchial Cavity, 566
- Bivalves, New, from Falkland Islands, 304
- Black, C. A., Imbedded Antheridia in Dryopteris and Nephrodium, 50
- Blackening of Green Leaves, 335
- Blain, A. W., Myiasis Narium, 716
- Blazit, L., New Trematode from Frog, 459
- Blastula, Spermatozoa entering a, 442
- Bleaching Methods, 380
- Blindworm, Development, 443

- Blomfield, J. E., Mycetozoan Parasites, 221
 Blood, M., 797, 806
 Blood and Connective-tissue, Researches, 114
 — Cells, Red, in Chick, Development, 151
 — — — — Studying Development, 114
 — Coagulation in Arthropoda, 574
 — Corpuscles, Enumeration, 231
 — — in Gammarus, Agglutination, 313
 — — Red, Mammalian, 297, 708
 — Demonstrating Tubercle Bacilli in, 673
 — Development, 442
 — Examination for Trypanosomes, etc., 247
 — in Toad, Origin, 556
 — Mammalian, Observations on, with Dark-field Illumination, 108
 — — Studied with Dark-field Illumination, 154
 — Morphological Demonstration of Methæmoglobin, 788
 — Nucleated Red Corpuscles in Blood-vessels of the Hypophysis, 707
 — of Amphibia, Studying the Morphology, 383
 — of Amphibians, 446
 — Platelets, Staining, 783
 — Smears, Staining, 785
 Blood-coagulation in Gammarus, 719
 Blood-formation in Embryonic Mammalian Liver, 18
 Blood-vessels of Australian Earthworms, 35
 Bloomfield, E. N., Algæ of Suffolk and Norfolk, 65
 — *Lecidea mougeotiioides* in Britain, 495
 Bocchia, G., Tuberculosis in Cold-blooded Animals, 501
 Boeke, J., Van der Stad's Improved Rocking-microtome, 665
 Bodo and Trypanoplasma, Transition Types, 181
 Boeke, J., Demonstrating Motor End-plates, 114
 — Motor End-plate in Higher Vertebrates, 153
 Bohn, G., Movements and Sensory Reactions of *Veretillum cynomorium*, 38
 — Reactions of Sea-anemones, 726
 — Rhythm in Sea-anemones, 322
 Bolding, I., Ferns of the Dutch West Indies, 52
 Bolton, H., New Species of Fossil Cockroach, 310
 Bone and Dentine, Development, 150
 — in Birds, Regeneration, 557
 — in Sunfish, Structure, 708
 Bonnerot, S., Cementation by Solid Carbon, 392
 Bonnet, A., Fixation of Algæ by means of Quinine, 521
 — Fixing of Algæ, 614
 Bouvicini, G., Microscopical Sections through both Cerebral Hemispheres, 379
 Borcea, I., Development of Heart in Teleosts, 18
 — Intermediary Mesodermic Mass in Teleost Embryos, 18
 Bordas, L., Glands in Caterpillars, 572
 — Malpighian Tubes in Larval Lepidoptera, 306
 — Thoracic Glands in Caterpillars, 305
 Bordet, J., Morphology of the Microbe of Peripneumonia of Cattle, 361
 Bordet, T., Microbe of Fowl Diphtheria, 758
 Bordier, H., Influence of Ultra-violet Rays on Trypanosomes, 464
 Boresch, K., Gum-flow in Relation to Anatomy in Bromeliaceæ, 182
 Børjesen, F., Greenland Fresh-water Algæ, 477
 — West Indian Floridææ, 69, 480
 Bornemann, K., The System Cu_2S-FeS , 261
 Borodine, J., Stomata of *Lycopodium annotinum*, 598
 Borrow, R., Useful Microscope Device, 760
 Bosse, A. W. v., Symbiosis between Algæ and Sponges, 480
 Bothriocephalus, Abnormalities, 172
 Botrychium, Interesting Habitat, 338
 — *Lunaria*, Orientation, 471
 — *ternatum* and its Allies, 51
 Bottini, A., Mosses of the Italian Islands, 738
 Bottle, Drop, New, 386
 Bottle-bacillus, 636
 Boubier, M., Stegmata in the Hymenophyllaceæ, 187
 Bouček, Z., New Bacillus of the Hæmorrhagic Septicæmia Group, 497
 Boudouard, O., "Damping" Test of Metals, 529
 Bouin, P., Ovarian Glands, 17
 Bonlet, V., Mycorrhiza of Fruit-trees, 493
 Bourdot, H., and others, Notes on Larger Fungi, 749
 Bourgeois, J., Case of Defensive Mimicry, 27
 Bouvier, E. L., Phylogeny of Atyidæ, 33
 — Ten-legged Pantopod, 717
 Bower, F. O., Phylogeny of the Filicales, I. Plagiogyria, 469
 Boyd, D. A., Fungi of the Clyde Area, 487
 Boyd, W. B., *Lastrea remota*, 734
 Boyer, G., Development of Truffles, 482
 Brain Microtome, Improved, 377
 — of American Alligator, 561
 — of Hive-bee, 164
 — Substance, Cutting thin Parallel Slices, 253
 — — Method of Preparing Frozen Sections, 378

- Branch Types and the Age of Trees, 591
 Brand, F., Fresh-water Species of *Chantrelia*, 70
 — *Trentepohlia*, 479
 Brass and Copper, 119
 Breeding, Use of Selection Index Numbers, 296
 Brefeld, —, Smut Infection of Wheat and Barley, 76
 Brémont, E., Crustaceans living in Ascidi-ans, 314
 — New Ascidicolous Copepods, 457
 — New Copepod from an Ascidian, 169
 Bridge, Land, Former, between Northern Europe and North America, 302
 Brimont, E., Trypanosome in an Edentate, 729
 Britton, E. G., C. F. Austin: North American Bryologist, 195
 — Mosses found in Conservatories, 342
 — and others, North American Bryophyta, 344
 Britzelmayer, Max, 753
 Brocher, F., Capillary Phenomena in Life of Fresh-water Animals, 24
 — Drawing with the Camera-lucida, 651
 Broekmann-Jerosch, H., New Fossil Discoveries and their Significance, 185
 Broeck, v. de H., Belgium Forms of *Harpidium*, 474
 Brohmer, P., Head of Embryo *Chlamydo-selachus*, 18
 Brölemann, H. W., Classification of Geophilomorpha, 168
 Bromeliaceæ, Gum-flow in Relation to Anatomy, 182
 Broniewski, W., Thermo-electric properties of Alloys, 529
 Bronzes, Corrosion, 676
 — Lead, 526
 — Zinc, 677
 Brooks, F. T., Development of *Gnomonia erythrostoma*, 745
 — Two Diseases of Gooseberry Bushes, 488
 Brooks, W. E., Cytology of the Ascus, 74
 Broom, R., Development of Marsupial Skull, 18
 — Organ of Jacobson in Ant-Bear, 158
 Broquet, C., Red Disease of Silk-worm Moth, 758
 Brothers, V. F., New Philippine Mosses, 59
 — Philippine Mosses, 738
 Brown, P. E., Quantitative Estimation of Soil Bacteria, 362
 Brown, R. N. R., Asteroids from Portuguese East Africa, 321
 — Echiuroids and Asteroids from Mergui and Burma, 321
 — from Portuguese East Africa, 321
 Brown, W. H., Embryo-sac of *Habenaria*, 47
 Browne, E. T., Antarctic Medusæ, 462
 Brozek, A., Variability of *Palæmonetes varians*, 313
 Bruce, D., Amakebe and East Coast Fever, 326
 Bruce, D., and others, Studies in Trypanosomes, 42
 Bruchmann, H., Prothallial Development in *Lycopodium*, 597
 — *Selaginella Preissiana*, 188
 Brückner, G., Comparative Value of recent Typhoid Culture-media, 375
 Brudny, V., New Hot-water Funnel, 246
 Brues, C. T., Parasitic Hymenoptera from the Tertiary of Florissant, 165
 Brubus, F., Nails of Primates, 298
 Brumpt, E., Pathogenic Role of *Balantidium coli*, 41
 Brünauer, E., Development of Vertebral Column in Grass Snake, 151
 Brunelli, G., Commensalism of Sea-anemones and Hermit-crabs, 718
 Brunthaler, J., *Glaethece rupestris*, 478
 Bruntz, L., Nephrocytes and Pericardial Cells of Orthoptera, 31
 Bruynoghe, R., Cultivation of Meningococci, 774
 Bryological Notes, 607
 — Rarities, 60
 Bryophyta, British, 193
 — Inter-relationships, 472, 606
 — North American, 194, 344
 — of Fiji, 60
 — of Ruwenzori, 58
 — of Sicily, 194
 — Scotch, 475
 — See CONTENTS
 Bryophytes, Japanese, 613
 — North American, 59, 475, 611
 — of Co. Donegal, 737
 — of Dunkerque, 737
 — of New Caledonia, 613
 — Russian, 56
 — Spanish, 610
 Bryozoa, Cretaceous, 460
Bryum argenteum, Abnormal Capsules, 735
 — *arvernense*, 60
 Bub, M., Apparent Bactericidal Influence of Colostral Milk, 710
 Bubak, F., Phytophthora Disease of Pears, 487
 — *Ustilago bulgarica* sp. n., 485
 — and others, Notes on Tilletiæ, 208
 Bucephalus, 459
 Buchanan, G., Blood-vessels of Australian Earthworms, 35
 Buchanan, R. E., *Monascus*, 624
 Buchner, P., Oogenesis of *Sagitta*, 316
 Bucholtz, F., Study of Balsamineæ, 482
 Budding and Shoot-formation of Hydroids, 175
 Bugnion, E., Cenobita and Acquired Characters, 455
 — Habits of *Cecophylla smaragdina*, 304

- Bugnion, E., Structure of *Trigonallys halni*, 571
- Bulbul's Blood, New Parasites, 729
- Bullcidae, Gill, 713
- Burgeff, H., Root-fungi of Orchids, 82
- Burgess, C. F., Influence of Arsenic and Tin upon Iron, 262
- Iron Alloys, 120
- Iron-copper Alloys, 120
- Iron-manganese Alloys, 120
- Magnetic Properties of Alloys of Iron, 391
- — of Iron and Alloys, 526
- Burlend, T. H., Urogenital Organs of *Chimæra monstrosa*, 711
- Burne, R. H., Aortic Ligament of Shad, 159
- Olfactory Organ of Teleosteans, 160
- Burri, R., Black Spot in Cheese, 352
- Burri's Indian-ink Method, 118
- Bursa Fabricii, Nature, 709
- Busck, A., Horn-feeding Lepidopterous Larvæ, 714
- Busse, O., Trichinosis in Posen, 36
- Butcher, T. W., Photomicrographs of Diatoms, 801
- Butignot, E., and others, Poisonous Fungi, 355, 751
- Butler, E. J., New Genus of Uredinaceæ, 748
- By-laws, 4 and 27, Alteration, 134
- Byssus-apparatus of Lamellibranchs, 304
- C
- Cabinets, Microscope Slide, 524
- Cactogorgia, New Species, 323
- Calandra, E., Differential Diagnosis of *Bacillus typhosus* and *Bacillus coli* by means of Coloured Cultivation Media, 521
- Calcite, Surface-flow, 123
- Callin, B., *Hastatella radians*, 589
- Callose and Fungose, Relations, 751
- Callus-formations in Nuphar, 466
- Calman, W. T., Blind Prawn from Galilee, 313
- Guide to Crustacea, Arachnida, Onychophora and Myriopoda of British Museum, 452
- Wood-boring Crustacea from Christmas Island, 314
- Calyptra and Archegonium, Biology, 54
- Cambier, R., Structure and Position of Pinakodendron, 192
- Cambridge Scientific Instrument Company, Large Sliding Microtome, 778
- Camels, Diurnal Variations of Temperatures, 22
- Camera-lucida, Drawing with, 651
- Campbell, D. H., Development of Angioperis and Kaulfussia, 594
- Campbell, D. H., New Flora of Krakatau, 48
- Prothallium and Embryo of *Danea*, 50
- Campbell, W., Heat-treatment of Iron and Steel, 262
- Camptosorus, Peculiar Habitat, 338
- Canada Balsam, Refractive Index, 372
- Cancer, Heredity in Connexion with, 705
- Capillary Phenomena in Life of Fresh-water Animals, 24
- Cappen, H., Breaking up of Cyanamides by Fungi, 487
- Capsules, Abnormal, in *Bryum argenteum*, 735
- Carabus auratus*, External Digestion, 307
- Carazzi, D., Bleaching Methods, 380
- Cooling of Paraffin Blocks, 380
- Fixation of Celloidin Sections, 384
- Carbon, Cementation, 122
- Solid, Cementation, 392
- Carbon-dioxide, Assimilation by Pupæ, 306
- Carbon-tungsten Steels, 391
- Cardamatis, J. P., Malaria in Birds of Greece, 40
- Cardioid or Aplanatic Condenser for Dark-ground Illumination, 515
- Cardioid-ultramicroscope, Allotropic Conversion of Phosphorus in, 653
- Cardot, J., Antarctic Mosses, 739
- Dicranoloma, 736
- Mexican Mosses, 345, 476, 613
- Mosses of Japan and Corea, 195
- Notes on Fontinalis, 343
- Sexuality in the Mosses, 603
- Carlier, E. W., Changes in Nuclei in Varying Physiological Conditions, 155
- Carlsson, A., Macroscelidæ, 299
- Carpenter, H. C. H., The "Growth" of Cast Irons after repeated Heatings, 390
- Carruthers, V. T., Simple Method of Counting Leucocytes, 259
- Carran, A., Development of Lymphatic Ganglia in Mammals, 150
- Cartilage, Hyaline, in Mammals, 446
- of Regenerated Amphibian Extremities, 297
- Selachian, Calcification, 446
- Cary, L. R., Life-history of *Diplodiscus temporatus*, 579
- Case-hardening, 790
- Cast-iron, Effect of Silicon and Sulphur, 678
- Molten, Specific and Latent Heats, 679
- Cat, Double Gall Bladder, 711
- Catenata, New, 460
- Caterpillars, Glands, 572
- Myrmecophilous, 714
- of *Epichnopteryx helicinella*, 570
- Thoracic Glands, 305
- Catouillard, G., Trypanosome of a Gecko, 326
- Cat's Arm, Vibrissæ, 157
- Caulerpa prolifera*, 617

- Caullery, M., and another. Infection of Ophiuroid with *Rhopalura*, 726
- Cavazza, L. E., Chemistry of Vegetable Pigments, 786
- Cavers, F., Inter-relationships of Bryophyta, 472, 606
- Cayeux, L., Calcareous Phosphates composed of Diatoms, 616
— Fossil Algae, 481
- Ceccarelli, O., Corrosion of Bronzes, 676
- Cedar-oil can, 394
- Cell Inclusions in Rabbit's Liver, 383
— Polyscopic, 673
- Cell-contents. *See* CONTENTS
- Cell-division, Theory, 445
- Cell-sap, Fungus, Chemical Study, 212
- Celloidin Sections, Numbering, 782
— — Serial, Mounting, 787
- Cells, Demonstrating Presence of Lipoids, 117
— Eosinophilous Staining, 118
— Hepatic, Mitochondria, 558
— Isolated, Life, 708
— Living, Visible Centrosomes, 558
- Cementation by Carbon, 122
— by Gases, 791
— by Solid Carbon, 392
— of Silicon Steels, 391
— of Steel, 527
- Cenobita, and Acquired Characters, 455
- Centrosomes, Visible in Living Cells, 558
- Cephalopoda. *See* CONTENTS
- Cephalopods, Dibranchiate, of Coasts of Ireland, 451
— Follicular Epithelium, 565
— Fossil, Beaks, 25
— Recent, Catalogue, 162
— Salivary Juice, 451
— so-called Olfactory Organ, 302
- Cephalothrix, Structure, 725
- Cephalotus and *Sarracenia*, Systematic Relationship, 184
- Ceratium hirundinella*, 478
- Ceratocorys, Revision of Genus, 729
- Ceratodon conicus*, 608
- Cercomonas, Observations on a Flagellate of the Genus, 660
- Cerebral Hemispheres, Microscopical Sections through both, 379
- Cerebratulus, Egg, 724
— *lacteus*, Ookinosis, 320
— Ovum, Experiments on Cleavage, 582
- Cerfontaine, P., Study of *Cerianthus oligopodus*, 39
- Cerianthus*, Californian Species, 463
— New Species, 322
— *oligopodus*, Study, 39
- Cestodes and Trematodes, Cuticula and Subcuticula, 318
- Cetacean Skull, Asymmetry, 299
- Cetrach, New Species, 339
- Chaetoceras Lorenzianum*, Microspore-formation, 64
- Chaetomium*, Study, 351
- Chairman, The, E. J. Spitta, 125, 128, 393-398, 796-798
- Chalon, J., The Roseoff Laboratory, 477
- Chantransia, Fresh-water Species, 70
- Chapman, F., Microzoa in Shales from New South Wales, 39
— New Species of *Leperditia*, 34
— On the Microscopical Structure of an *Inoceramus* Limestone in the Queensland Cretaceous Rocks, 1
- Chapman, J. C., Properties of Gold Leaf at High Temperatures, 387
- Chappellier, A., Peculiar Organ in Finches, 711
- Characæ, Bombay, 743
- Characium, 616
- Charpy, G., Cementation by Solid Carbon, 392
— "Strain-disease" in Steel, 791
- Chatelier, H. le, Constituents of Steel, 122
— Phosphides of Iron, 262
— Testing by Alternating Stress, 124
- Chatin, J., Structure of Sclerotic, 708
- Chatterjee, G. C., New Bacillus of Fowl Septicæmia, 364
— — Lactic-acid Streptothrix, 221
- Chatton, E., Crustaceans living in Ascidians, 314
— Double Nauplius, 34
— New *Ascidicolous* Copepods, 457
— — Copepod from an Ascidian, 169
— — Parasitic Amœbæ, 327
— Nucleus of Amœbæ, 728
— Parasites of Labridæ, 728
- Cheavin, H. S., Photomicrographs of Antennæ and Falces of Spider, 125
- Cheese, Black Spot, 352
— *Piophila* Larvæ in, 571
- Cheesemaking, Scientific, 498, 638, 757
- Cheetham, C. A., Yorkshire Mosses, 342
- Chemical Changes in Seed Plants. *See* CONTENTS
- Chemotaxis of Spermatozoids in *Marchantia*, 193
- Chevalier, A., Wild and Cultivated *Dioscorea* in Tropical Africa, 44
- Chiaronanza, R., Comparative Study of *Streptothrix pyrogenes* and *Actinomyces hominis*, 222
- Chiek, Development of Red Blood Cells, 151
— Studying Development of Red Blood Cells, 114
- Chilomonas, Cytoplasmic Fibrillation, 729
- Chiloschyphus and Heteroschyphus, 607
- Chimæra monstrosa*, Urogenital Organs, 711
- Chironomus Larvæ, Structure of Nucleus in Cells of Salivary Glands, 452
— Luminescence, 31
- Chitin, Distribution, 298

- Chitin in Nematode Development, Significance, 722
 — Study, 44
 Chitons, Revision, 162
 Chittenden, F. J., and others, Plant Diseases, 213
 Chlamydoselachus and Dogfish, Vestiges of Thyroid, 562
 — Head of Embryo, 18
 Chloroplast-movements, 184
 Choanoflagellata, Notes, 325, 464
 Chodat, R., Green Snow, 203
 — Polymorphism of Algae, 349
 Cholera Bacillus, prepared by Löffler's Method, Measurement of the Diameter of the Flagella, 290
 — Vibrios, Isolation, 653
 — in Peptone Solutions of Different Reactions, Morphology, 364
 Chondriome, Role in Secretion, 709
 Chondriosomes of Embryonic Cells and Mitochondrial Elements of Germ-cells, 294
 Chopping, F. R., Drop-bottle, 386, 394
 — "Solmedia," 372, 393
 Chordæ Tendinæ and Papillary Muscle, Junction, 155
 Chordoid Tissue, 708
 Christ, H., Ferns of Corea and China, 340
 — of Costa Rica, 191, 340
 — of New Guinea, 191
 — of South China, 603
 — of the Far East, 53
 — Geography of Ferns, 600
 — New Species of Malesian and Philippine Ferns, 53
 — Two Species of Platycerium, 601
 Christensen, C., American Species of Dryopteris, 191
 — Olaf Swartz's Types of Ferns, 600
 Chromatophores, and Nucleus, Connecting Threads, 329
 — Form and Change of Position, 329
 Chromium, Manganese and Vanadium, Magnetic Properties, 526
 — Steel, 790
 — — A₂ point, 790
Chromodora elegans, Tentacular Anomaly, 566
 Chromosomes in *Oenothera*, 43
 — in *Osmunda*, 187, 330
 — Number in Batrachians and in Parthenogenetic Embryos, 706
 — of *Asphodelus microcarpus*, 182
 Chrysler, M. A., Fertile Spike of the Ophioglossaceæ, 186
 Chrysomonadinæ, New Genus, 203
 — of Bohemia, 203
 Chrysomonads, Three New, 346
Chrysopa perla, Minute Structure of Gut, 309
 Chytridiaceous Fungus, New, 622
 Chytridinæ, New Genus, 481
 Chytridiopsis, 42
 Ciaccio, C., Demonstrating the Presence of Lipoids in Cells, 117
 Ciliary and Muscular Movements, Relation between, 298
 Cilimbaris, P. A., Demonstrating Musclespindles, 664
 Cinematography, Ultramicroscopic, of Living Microbes and Moving Particles, 100
 Circulation, Frog's, Abnormalities, 449
 Cladocera, Generation-cycles, 31
 — Rudimentary Antennary Gland, 34
Cladotrix stereotropa, 222
 — *vaccinæ*, 365
 Clark, A. H., Affinities of Echinoidea, 322
 — New Genus of Unstalked Hydroids, 586
 Clark, E. D., Studies in Pyrophilous Fungi, 623
 Clark, H. L., Echinoderms of 'Thetis' Collection, 174
 Clasmatocytes, 558
Claviger testaceus, Structure and Habits, 571
 Claws of Amniota, Embryonic Appendage, 149
 Clegg, M. T., Cultivation of the Leprosy Bacillus, 521
 Cleland, J. B., Diurnal Variations in Temperatures of Camels, 22
 — Hæmoprotzoa in Birds of New South Wales, 40
 Clements, F. E., Genera of Fungi, 79
 Clendinnen, F. J., Micrometric Measurements by a Projected Scale, 368
Clinodiplosis equestris, 127
 Closterium, 478
 Cloup, F., Testing Steel by Corrosion, 793
 Clusiaceæ of North-west Madagascar, 732
 Clute, W. N., and others, North American Ferns, 339
Cnethocampa pinivora, Procession and Pupation of Larvæ, 715
 Cnidoblasts of Hydra, 176
 Cnidosporida in Mayfly Larvæ, 465
 Cobalt Alloys, 388
 — and Nickel, Magnetic Transformation, 124
 — Phosphorus Compounds, 261
 Cobalt-gold Alloys, 525
 Coccoi, Gram-negative, from Human Con-junctiva, 636
 — Rennet-forming, in Cheese, 757
 Coccidian in Bile-ducts of Agama, 328
Cocobacillus conjunctivæ, 87
Coccobacillus, Pathogenic, New, 363
Coccomyxa subellipsoidea, a New Member of the Palmellaceæ, 61
 Cockroach, Fossil, New Species, 310
 Cockroaches, Nuclear Components in Sex-cells of four Species, 31
 Cocoa, Hemiptera Injurious to, 716
 Cœlentera. See CONTENTS

- Cœlenterata, Collecting, and Observations on the Ova, 112
- Cœlomic and Vascular Systems in Lologo. Development, 161
- Cohen, E., Metastability of Metals, 389
— Zinc Amalgams, 676
- Coker, W. C., Leptolegnia from North Carolina, 73
— Liverwort Types for Elementary Classes, 54
— North American Bryophytes, 59
— Vitality of Pine Seeds, 47
- Coleochaete, 616
- Coliform Organisms. Stability of Physiological Properties, 362
- Collecting and Growing Algae, Hints, 198
— and Preserving Insects, 112
— Cœlenterata and Observations on the Ova, 112
— Living Foraminifera, 661
- Collecting Objects. See CONTENTS
- Collembola and Thysanura of Midland Plateau, 572
— Post-Antennary Organ, 453
- Collin, B., Conjugation in Anoplophrya, 179
— Hypertrophied Acinetæ, 40
— New Species of Opercularia, 41
— — Suctoria, 326
— Notes on Suctoria, 179
— Symmetry of Embryo Acinetæ, 40
- Collinge, W. E., Thysanura and Collembola of Midland Plateau, 572
- Collins, F. H., On the Labelling of Microscope Slides, 267
- Collins, F. S., Algological Prophecy fulfilled, 63
- Colour Change in a Ratel, 448
— in Ligia, 719
— in Lychnis, Inheritance, 337
— Reaction, New, for certain Albumins, 522
- Colours of Equidæ, 22
- Colpomenia sinuosa*, 68
- Comandon, J., Ultramicroscopic Cinematography of Living Microbes and of Moving Particles, 100
- Comb of Domestic Fowl, Variation, 23
- Commensalism of Sea-anemones and Hermit-crabs, 718
- Comparator, Wave-length, for Standards of Length, 107
- Complement in Glanders, Fixation, 87
- Comspogon, 619
- Compton, R. H., Anatomy of *Matonia sarmentosa*, 49
- Conceptacles and Cryptostomata of *Fucus vesiculosus*, 743
- Condenser, Achromatic, Apparatus for Increasing the Power, 534
— Aplanatic or Cardioid for Dark-ground Illumination, 515
— Leitz Mirror, Improvements, 761
- Cones of Selaginella, 598
- Congress Notes, 613
- Coniferae, Phyletic Significance of Ray Tracheids, 731
- Coniophora cersbella* as Timber-destroyer, 485
- Conjugation in Anoplophrya, 179
- Conjunctiva, Human, Gram-negative Cocci, 636
- Connective-tissue and Blood, Researches, 114
— Fibrils, Origin of, and Structure of Embryonic Supporting Tissue, 298
— Framework of Viscera, New Method of Staining, 116
- Conocephalum, Sporogonium and Gametophore, 53
- Conor, A., *Micrococcus melitensis* and Malta Fever, 361
- Conradi Medium, Modifications for Isolating *Bacillus typhosus* from Excreta, 112
- Conrady, A. E., 126, 271, 395, 534
- Conte, A., Caterpillars of *Epichnopteryx helicinella*, 570
— Development of Eggs of Silk-moth, 305
— Vitellus in Silk-moth's Eggs, 30
- Cook, F. J., Structure of Cast Iron, 263
- Cook, M. T., Embryology of the Nymphaeaceæ, 47
- Cooke, M. C., British Basidiomycetes, 750
- Cooper, C. F., Nemerteans from Eastern Indian Ocean, 319
- Cooper, J. E., New Bivalves from Falkland Islands, 304
- Copeland, E. B., Ferns of the Philippines, 191
- Copepod, New, from an Ascidian, 169
- Copepods, New Ascidicolous, 457
- Copper and Brass, 119
— and Nickel Alloys, 387
— Microstructure, 260, 387
- Copper-aluminium Alloys, 387
- Copper-aluminium-manganese Alloys, 789
- Copper-arsenic Alloys, 676
- Copper-tin Alloys, 119
- Copper-zinc Alloys, 675
- Coppey, A., Hepatics of the Haute-Saône, 56
— Moss-flora of Greece, 57
— — of the Haute-Saône, 610, 737
— Regeneration in the Hepaticæ, 472
- Coprinus stiriacus*, Geotropism and Growth in Length, 485
- Corallinaceæ, 71
- Corals, Fossil, from Ceram, 324
- Cordylobia, New, 716
- Cornet, A., Revision of the Species of *Philonotis*, 473
- Corrosion, Testing Steel by, 793
- Cory, C. B., Birds of Illinois and Wisconsin, 300
- Corymorpha, New Japanese, 464

- Coseinodiscus astromphalus* in a Balsam Mount. On the Visibility of the Tertiaries, 147, 270
 — — On the Resolution of New Detail, 698, 797
 Cossar, J., Restoration of Ancient British Race of Horses, 299
 Cotte, J., New Gall-mite on Hawthorn, 454
 Council, New, 132
 — Report, 130
 Counting Leucocytes, Simple Method, 259
 Coupin, H., Growths of Moulds in Oil, 484
 Courtship of Spiders, 573
 Coutière, H., Dimorphism of Males in Saron, 718
 — Snapping Shrimps, 577
 Coward, W. E., New Gymnoblatic Hydroid Epizoa on a Pennatulid, 323
 Coyle, R. F., Development of Auditory Ossicles in Horse, 150
 Crabs, Fresh-water, Indian, 575
 — Hermit, Habits, 456
 — Robber, Habits, 455
 Craig, W., Expressions of the Emotions in Pigeons, 561
 Crampton, C. B., and others, British Bryophyta, 193
 Cranial Anatomy of Mail-checked Fishes, 160
 — Nerve, Eighth, Peripheral Terminations, 154
 Crawfishes, Sex-recognition, 312
 Crawley, H., Cryptobia and Trypanoplasma, 180
 — Mammalian Blood Studied with Dark-field Illumination, 154
 — Observations on Mammalian Blood with Dark Field Illumination, 108
 — Studies of Trypanosomes, 180
 Crendropoulo, —, Simple Anaerobic Method, 660
 Crendropoulo, M., Isolation of Cholera Vibrios, 663
 Crenilabrus and Hippolyte, Light and Pigment-formation, 719
Crepitula fornicata, Hermaphroditism, 163
Critiëidia melophagia, Encystation, 465
 — Studying Structure and Life-history, 664
 Critical Microscopy, 282, 395
 Crosby, C. R., Seed-infesting Chalcis-flies, 31
 Crouan, Brothers, 204
 Crucifera, Studying the Development, 256
 Crustacea, Arachnida, Onychophora, and Myriopoda of the British Museum, Guide to, 452
 — in Gizzard of Deep-sea Cuttle-fish, 314
 — Sympathetic Nervous System, 573
 — Wood-boring, from Christmas Island, 314
 Crustacea. See CONTENTS
 Crustaceans, living in Ascidians, 314
 — Minute Structure of Respiratory Organs, 33
 Cryptobia and Trypanoplasma, 180
 Cryptogams, Lancashire, New, 745, 756
 — See CONTENTS
 Cryptostomata and Conceptacles of *Fucus vesiculosus*, 743
 Crystalline Structure of Iron at High Temperatures, 389
 Crystals, Behaviour in Light Parallel to an Optic Axis, 657
 — Fluid, Axial Images, 658
 — Mixed, Composition in Alloys, 392
 — — or Solid Solutions, 794
 Ctenophore Ovum, Cleavage, 585
 Ctenophores, Medusoids and Medusæ, of Firth of Forth, 176
 Cuénot, L., Heredity in Connexion with Cancer, 705
 Cufino, L., East African Ferns, 471
 — — — Mosses, 476
 Culicidæ, West African, Larvæ and Pupæ, 716
 Culmann, P., Swiss Mosses, 737
 Culpeper and Scarlet Microscope, 400
 Cultivating *Bacillus tuberculosis*, 521
 — Meningococcus, 110
 — *Spirochæta pallida*, 111
 Cultivation of *Leishmania Donovanii* in Fluid Media, 245
 — of Leprosy Bacillus, 521
 — of *Oidium albicans* from Throats, 375
 — of *Spirochæta gracilis* and *S. balantidis*, 110
 — of the Tubercle Bacillus upon Animal Tissues, 375
 Culture, Artificial, of Marine Plankton Organisms, 374
 — Media, New Method of Preparing, 663
 — — Recent Typhoid, Comparative Value, 375
 — Processes. See CONTENTS
 Cultures, Aerobic, of "Anaerobic" Organisms, 111
 — Laboratory, under Gas, 197
 — Microbic, Testing for Indol, 373
 — Plate, Method of Staining Deep Colonies, 672
 — Pure, New Method for obtaining from Whole Organs and Pieces of Tissue, 111
 Cumacea and Schizopods, Antarctic, 575
 Curry, B. E., Some Zinc Alloys, 260
 Curties, C. L., 536
 Curties, M. R., Ligaments of Oviduct of Domestic Fowl, 447
 — Reproduction in the Domestic Fowl, 556
 Curve, Sintering-point, 392
 Cushman, J. A., New Genus of Arcnaceous Foraminifera, 589
 Cutleria and Aglaozonia, Cytology, 69

- Cutore, G., Glands in Gall-bladder of Dog, 447
- Cutting, E. M., Androgynous Receptacles in Marchantia, 472
- Cutting Objects. *See* CONTENTS
- Cuttle-fish, Deep-sea, Crustacea in Gizzard, 314
- Cyanamides, Breaking up by Fungi, 487
- Cynodotium Jenneri*, 608
- Cysticeri and Echinococci, Presence of Bacilli, 88
- Cysticeroid from a Jerboa-flea, 581
- Cystosira and Sargassum, 479
- Cytological Observations on the Yeast Plant, 207
- Cytology of Cutleria and Aglaozonia, 69
- of the Ascus, 74
- of Varietal and Hybrid Ferns, 189
- of Yeasts, 351
- *See* CONTENTS
- Cytoplasm and Nucleus, Relations, 444
- Cytoplasmic Fibrillation of Chilomonas, 729
- Czapek, F., Indian Ocean Plankton, 200
- D
- Dactylopius, Eyes, 29
- Daday, E. v., East African Entomostraca, 720
- Fresh-water Microfauna of German East Africa, 450
- Rotifera of Turkestan, 173
- Dadoxylon, New Fossil, 192
- Dahl, F., Mites in Tumours, 455
- Dahlia Stain, New, 786
- Dakin, W. J., Intensive Study of Plankton around South End of Isle of Man, 562
- Studying Eye of Pecten, 376
- Dall, W. H., Monograph of West American Pyramidellidæ, 164
- Dallinger, Dr., the late, 125
- Dampf, A., Cysticeroid from a Jerboa-flea, 581
- “Damping” Test of Metals, 529
- Danæa, Prothallium and Embryo, 50
- Daniel, J. F., Adaptation and Immunity of Infusorians to Ethyl-alcohol, 588
- Daniel, M. J., Branch Types and the Age of Trees, 591
- Danila, P., *Cladotrix stereotropa*, 222
- Danilov, U. N., Relation between Gonidia and Hyphæ in Lichens, 494
- Darbishire, O. V., Arctic Lichens, 84
- Dark-field Illumination and Ultramicroscopy in Biology and in Medicine, 367
- Observations on Mammalian Blood, 108
- Dark-ground Illumination, 98
- Darwinism, Study, 149
- Dasycladus claviformis*, 616
- Davainea, New Species, 37
- Davies, John Henry (1838-1909), 61
- Davis, B. M., Sexual Reproduction in Algae, 740
- Dawydoff, C., Regeneration in Euterozoans, 173
- Day, A. L., Nitrogen Thermometer, 265
- Debaisieux, P., Oogenesis in *Dytiscus marginalis*, 166
- Decapod Natantia of Coasts of Ireland, 576
- Decapoda from North Side of Bay of Biscay, 456
- Decapods, Rare, 718
- Decarburisation of Cast Iron by Gaseous Oxidising Agents, 527
- Décombe, M. L., Measurement of the Refraction Index of Liquids by the Microscope, 243
- Deegener, P., Abdominal Sensory Organ in Noctuidæ, 30
- Intestinal Secretion in Deilephila, 30
- Dehaut, G., Lungless Salamandrid, 24
- Dehorne, A., Number of Chromosomes in Batrachians and in Parthenogenetic Embryos, 706
- Dehydration, Device for Protecting Mounted Sections during, 257
- Improved Method, 249
- Deilephila, Intestinal Secretion, 30
- Delage, Y., Alleged Influence of Electric Discharges in Inducing Parthenogenesis, 293
- Demoll, R., Eye of *Alciopa cantrainii*, 35
- Mouth-parts of Wasps and other Hymenoptera, 164
- Demoussy, —, Blackening of Green Leaves, 335
- Dendrobrachia fallax* Brook, Note on a Rare and Remarkable Antipatharian, 142
- — a Rare and Divergent Antipatharian, Notes on, 266
- Dendroceros, 475
- Dendrocælum, New Parasites, 41
- Dendrogorgia, New Pseudaxoniid Genus, 323
- Dentine and Bone, Development, 150
- in Mammals, Development, 557
- Studying the Development in Mammalia, 258
- Dentition, Milk, Significance, 299
- Desmids, 201, 347
- from Macedonia, 347
- Serpian, 347
- Desroche, P., Vaucheria, 617
- De Toni, G. B., Fresh-water Algae from Ruwenzori, 64
- M. H. Foslie, 205
- Deton, W., Synapsis in *Thysanozoon brocchi*, 171
- Development and Origin of Respiratory Organs in Araneæ, 310
- Experimental Study during the past decade, 258

- Development of *Agelastica alni*, 308
 — of Amphioxus, Studying, 115
 — of Eggs of Silk-moth, 305
 — of Lung-books and Tracheæ in Spiders, 312
 — of Seed Plants. See CONTENTS
 Diatom, Interesting, near Hull, 66
 — New, 743
 Diatomaceous Dust on the Behring Sea Ice-floes, 67
 Diatoms, Calcareous Phosphates composed of, 616
 — Devonshire, 201
 — Fossil, 202
 — of Madeira and Porto Santo, 347
 — of Sedberg District, 615
 — Photomicrographs by T. W. Butcher, 801
 — Physiology, 67, 615
 — Portuguese, Catalogue, 347
 Dicranoloma, 736
Dicranoweisia robusta Vent, What is? 608
Dictyota dichotoma, 197
 — Periodicity, at Naples, 618
 Dietzow, L., Prussian Mosses, 737
 Diffraction and Micrometric Rulings, On the Production, 239
 Digby, L., Cytology of Varietal and Hybrid Ferns, 189
 Digestion, External, in *Carabus auratus*, 307
 — in Marine Invertebrates, 561
 Digestive System of Schizopods, 169
 Dinophilus and Larvæ of Polygordius, Echinurus, and Phoronis, Nephridia, 316
 — *conklini*, Parthenogenesis, 316
 — Hæmocœle, 460
 Dinosaurs, Attitude, 23
 Dioscorea, Wild and Cultivated in Tropical Africa, 44
 Diphtheria Bacilli, Modification of Neisser's Staining, 522
 — Fowl, Microbe, 758
 Diplococcus, Lanceolate, Disease of Sheep caused by, 636
Diplodiscus temporatus, Life-history, 579
Diplogonoporus brauni, 582
 Diplonema, Living Species, 306
 Diplopoda, Studies, 163
 Diptera, Blood-sucking, Roumanian, 571
 — Parasitic, Adaptations, 453
 Dipterous Larvæ, Head and Mouth-parts, 453
 Diseases, Plant, 79, 213, 356, 630, 752
 — — American Text-book, 630
 — — Causes, 88
 — — Review, 629
 Disinfection, Investigations, 497
 Dismier, G., Mosses of the Pyrenees, 344
 Disse, J., Development of Bone and Dentine, 150
 Distomid Cyst in Blood-vessels of an Oligochæt, 459
 Dixon, H. H., Osmotic Pressure in Plants, 593
 Dixon, H. N., Accessory Leaves in Mnium and Orthomnium, 55
 — *Cynodontium Jenneri*, 608
 — "Neolithic" Moss Remains, 609
 — Some Irish Forms of Fissidens, 473
 — and another, Mosses of Western India, 738
 Dodge, R., and others, North American Ferns, 602
 Dodson, E., Method of Staining Deep Colonies in Plate Cultures, 672
 Doelter, C., New Heat Microscope, 366
 Doflein, F., Treatise on Protozoa, 325
 Dog, Glands in Gall-bladder, 447
 Dogfish and Chlamydoselachus, Vestiges of Thyroid, 562
 Dogiel, V., New Catenata, 460
 Dogs, Hybrid, Litter, 153
 Dold, H., Bottle bacillus, 636
 Dollo, L., Antarctic Macrurid, 159
 — Studies on Fishes, 34
 Doncaster, L., Gametogenesis of Gall-fly, 569
 Douin, I., *Bryum arvernense*, 60
 — Protonema and Propagules in Hepaticæ, 605
 Downing, E. R., Oogenesis of Hydra, 175
 Dragoiu, J., Seasonal Migration of Fat in the Frog, 24
 Dragon-fly, Agrionid, Life-history, 166
 — Development, 568
 Drawing and Projection Apparatus, Edinger's, Application to Macroscopic Photography, 230
 — Apparatus, Abbe's, Measuring Inclination of, 761
 — on a Transparent Drawing-surface, 517
 — with the Camera-lucida, 651
 Drenkelfort, H., Study of an Ephemered, 571
Drepanocladus furcatus, 60
 — Notes, 343
 — Some Forms, 60
 Drew, G. H., *Laminaria digitata* and *L. saccharina*, 196
 Drop Bottle, New, 386, 394
 Dryopteris, American Species, 191
 — and Nephrodium, Imbedded Antheridia, 50
 — Hybrids in North America, 471
 Drzewina, A., Habits of Hermit Crabs, 456
 Du Plessis, G., Hermaphroditism of *Prosochromus claparedi*, 725
 Dubreuil, C., Hyaline Cartilage in Mammals, 446
 Ducelliez, F., Alloys of Cobalt, 388
 Duck, Development of Lymphatic Ganglia, 294

- Dudgeon, G. C., Hemiptera Injurious to Cocoa, 716
- Duesberg, J., Mitochondrial Elements of Germ-cells and Chondriosomes of Embryonic Cells, 294
- Duggar, B. M., American Text-book of Plant Diseases, 630
- Duke, H. L., Observations on a New Gregarine *Metamera schubergi*, g. et sp. n., 659
- Dunkerley, J. S., Notes on Choanoflagellata, 325, 464
- Dunstan, A. E., Lead and Tin Alloys, 119
- Dürken, B., Influence on Nervous System of Extirpation of Limb-primordia in Frog Embryos, 706
- Dustin, A. P., Thymus of Reptiles, 20
- Dytiscus marginalis*, Oogenesis, 166
- E
- Eames, A. J., Centripetal Xylem in Equisetum, 50
- Earland, A., 807
- Collecting Living Foraminifera, 661
- On the Recent and Fossil Foraminifera of the Shore Sands of Selsey Bill, Sussex—V. The Cretaceous Foraminifera, 401; VI. A Contribution towards the Ætiology of *Massilina secans*, 693
- Some Varietal Forms of *Massilina secans*, 796
- Earthworms, Australian, Blood-vessels, 35
- of Ruwenzori, 315
- Echeneis, Suctorial Disc, 301
- Echinocardium and Spatangus, Mode of Feeding, 174
- Echinococci and Cysticerci, Presence of Bacteria, 88
- Echinococcus Disease, Detection, 459
- Echinoderma. See CONTENTS
- Echinoderms, Indian Ocean, 461
- New Zealand, 461
- of "Thetis" Collection, 174
- Reactions, 321
- Echinoidea, Affinities, 322
- Echinoids and Asteroids from Mergui and Burma, 321
- from Portuguese East Africa, 321
- Echinoneus, Teeth and a Lantern, 37
- Echinorhynchus Larva in Tench, 37
- Ectoparasites and Endoparasites of Grouse, 167
- Edelbüttel, H., Parasitic Floridææ, 743
- Edentate, Trypanosome in, 729
- Edentates, Classification, 151
- Edgerton, C. W., *Trochila Populorum*, 623
- Edinger's Drawing and Projection Apparatus, Application to Macroscopic Photography, 230
- Edwards, C. A., Aluminium-copper-tin Alloys, 675
- Aluminium-copper-tin System, 119
- Edwards, C. L., Development of *Holothuria floridana*, 174
- Edwards, T. G., Procession and Pupation of Larvæ of *Cnethocampa pinivora*, 715
- Effenberger, W., Structure of Polydesmus, 310
- Egg, Double, in Porbeagle Shark, 294
- of Birds, Vitelline Membrane, 293
- of Cerebratulus, 724
- of Fowl, Unfertilised, Segmentation, 442
- of *Mutinus caninus*, Deformation, 78
- of Rhinophis, 294
- Eggs, Fertility and Hatching, 85
- Fresh, Chemical and Bacteriological Study, 635
- Frog's, Artificial Parthenogenesis, 706
- of Chrysomelid Beetles, Effect of Centrifugal Force, 308
- of Silk-moth, Development, 305
- of *Tennocephala fasciata*, Hardening and Imbedding, 114
- Silk-moth's Vitellus, 30
- Eijkman, C., Investigations on Disinfection, 497
- Eisenberg, P., Nile-blue Staining for the Demonstration of Metachromatic Granules, 381
- Elasmobranchs, Segmental Structure of Motor Nerve Plexus, 449
- Elders, C., Trypanosomiasis in Man in Sumatra, 464
- Electric Current, Detection of Bacteria by means of, 110
- Electricity and Micro-organisms, 496
- Electrolysis, Ultramicroscopic Examination of Liquids during, 658
- Electron Theory and Solid Solutions of Metals, 529
- Elenkin, A. A., Russian Fresh-water Algae, 621
- Russian Lichens, 218
- Elentheria, Life-cycle, 323
- Ellingen, K., Influence of Antimony and Tin on the Iron-Carbon System, 679
- Ellis, D., Further Study of New Iron-bacteria, 365
- Elmassian, M., New Amœba in Man, 40
- Two New Parasites from Tench, 42
- Elmhirst, R., Notes from Millport Biological Station, 301
- Elopidae and some other Teleosteans, Caudal Fin, 449
- Elpatiewsky, W., Primitive Germ-cells in Sagitta, 170
- Embryo, Abortive, of *Salamander atra*, 152
- and Prothallium of Danæa, 50
- Embryo-sac of Habenaria, 47
- of *Smilacina stellata*, 46

- Embryology and Flower-morphology of
Datisca, 183
 — of *Encephalartos*, 331
 — of *Penæaceæ*, 183
 — of the *Nymphaeaceæ*, 47
 — of *Vertebrata*. See CONTENTS
 Embryonic Tissues, Delicate, Preparing
 for Histological Examination, 251
 Embryos, Fish, Study of Heart-action, 160
 — Frog, Influence on Nervous System of
 Extirpation of Limb-primordia, 706
 — from the Maternal Tissues of the
 Rat, Method of Examining, 246
 — Intra-uterine, of Saw-fish, 706
 Emotions, Expression of, in Pigeons, 561
 Empidiæ, 306
 Encephalartos, Embryology, 331
 Encystation in *Crithidia*, 465
 — Protective, of Fresh-water Nemertean,
 319
 End-plate, Motor, in Higher Vertebrates,
 153
 End-plates, Motor, Demonstrating, 114
 Endoderm in Mole-cricket, Development,
 166
 Endodermis, Function of, and Selective
 Absorption by Protoplasm, 591
Endomyces albicans, Yeast-cells, 625
 — on Apples, 745
 Endomyces. Study, 206
 Endoparasites and Ectoparasites of Grouse,
 167
 Engel, H., Rostral Teeth of *Pristis*, 301
 Engler's Pflanzenfamilien, Supplement,
 200
 Engrafting Gonads, 705
 — Tissues, 705
 Enock, F., On the Life-history of the
 Hessian-fly, with Notes on the Tenby
 Wheat-midge, 127
 Enteropneusts, Regeneration, 173
 Entochorda, Significance, 157
 Entomogenous Fungus, Important, 626
 Entomology, Outlines, 27
 Entomostraca, East African, 720
 Entozoa of Monotremes and Marsupials,
 319
 — Relation to Bacterial Disease, 25
 Entz, G., sen., Mimicry, 558
 Enumeration of Blood Corpuscles, 231
 Ephemerid, Study, 571
Ephemeropsis tjibodensis, 608
Epichnopteryx helicinella, Caterpillars, 570
 Epidoscope, Krüss, 229
 Epiphytes of *Laminaria*, 196
 Epithelium, Follicular, of Cephalopods, 565
 — Mucous, 445
 Equidæ, Colours, 22
 Equisetum, Centripetal, Xylem, 50
 Ergot, New Observations, 482
 Eriksson, J., Mildew of Apples, 746
 — and another, American Gooseberry
 Mildew, 746
 Ernst, A., *Ephemeropsis tjibodensis*, 608
 Eryonidæ, Jurassic and Modern, 313
 Esch, P., Cultivating Meningococcus, 110
 Escherich, K., Ants and Plants, 452
 — Termites and Fungus-culture, 79
 Euproctos, Epidermic Papillæ, 154
 Eutectics, Invariant Systems and Com-
 position, 528
 Evans, A. W., Hepaticæ of New England,
 59
 — Vegetative Reproduction in *Metzgeria*,
 472
 Evans, T. J., British Millipedes, 717
 Evans, W., Fauna of Forth Area, 450
 — Medusoids, Medusæ, and Ctenophores
 of Firth of Forth, 176
 Ewell, M. D., Comparative Micrometric
 Measurements, 399, 537
 — Convenient Form of Stand for Use as a
 Micro-colorimeter and with the Micro-
 spectroscope, 14, 127
 Ewert, —, Wintering of Fungus Spores,
 355
 Excretory System in Triclad, 37
 Exhibition by F. W. W. Baker, Sections
 of Eyes, illustrating their Structure
 and Development, 130
 — of British Mycetozoa, 802
 — of Pond-life, 798
 Exobasidium on *Azalea*, 77
 Eye, Nematodes, 458, 317
 — of *Alciopa cantrainii*, 35
 — of Pecten, Studying, 376
 — Turkey's, *Filaria*, 722
 Eye-piece, variable, 800
 Eye-pieces. See CONTENTS
 Eyes of *Dactylopius*, 29
 — of *Gammarids*, 313
 — of Pentamerous Beetles, 307
 — of Placophora, 162
 — of *Polystomum integerrimum*, 582

F

- Faber, F. C. v., Germination of Uredospores
 of *Hemileia vastatrix*, 626
 Fæces, Detection of Tubercle Bacilli in,
 672
 Fage, L., Variation in Mullet, 161
 Fairy Rings, 749
 Falck, R., Disease of Pine Wood, 488
 Fally, V., Microbe of Fowl Diphtheria,
 758
 Fantham, H. B., *Bacillus arenicolæ*, 86
 — Disease in *Arenicola*, 35
 Farmer, J. B., Cytology of Varietal and
 Hybrid Ferns, 189
 Fasciolopsis, 581
 Fat in the Frog, Seasonal Migration, 24
 Faull, J. H., Stele of *Osmunda cinnamomea*, 595
 Fauna, Microscopic, at Cape Royds, 450

- Fauna of Forth Area, 450
 Fauré-Fremiet, E., Symbiosis exhibited by a Ciliated Infusorian, 41
 Fawcett, H. S., Important Entomogenous Fungus, 626
 — and another, Notes on Microfungi, 750
 Fawcett, H. B., Modification of the Conradi Medium for Isolating *Bacillus typhosus* from Excreta, 112
 Fay, H., and others, Defects in Steel Rails, 263
 Felder, —, Tuberculo-opsonic Index in Man and in Cattle, 363
 Fellner, O. O., State of Ovary during Pregnancy, 441
 Felser, H., Effects Produced by Rolling, 792
 Felt, E. P., Injurious Insects, 717
 Feoktistow, A., New Method for obtaining pure Cultures from whole Organs and Pieces of Tissues, 111
 Ferdinandsen, C., Mycological Notes, 629
 Ferments and Latent Life of Resting Seeds, 48
 — of Fungi, 212
 Fern, European, New, 602
 — Prothallia, Culture, 600
 — — Peculiar, 599
 Fern-flora, North American, 51
 Fern-prothallia, Fertilisation, 189
 Ferus, Apogamy, Hybridisation and Heredity, 470
 — East African, 471
 — Fertilisation and Hybridisation, 470
 — Fossil and Living, Structure, 49
 — — Assimilating-tissue, 596
 — of France, 596
 — — New, 190
 — Geography, 600
 — Indian, 735
 — Italian, 339
 — Japanese, 192
 — New Species of Malesian and Philippine, 53
 — North American, 51, 339, 602
 — — — New, 602
 — of Argentina, 603
 — of Corea and China, 340
 — of Costa Rica, 191, 340
 — of New Guinea, 191
 — of New York Botanical Garden, 339
 — of Ruwenzori, 53
 — of South China, 603
 — of the Congo, 52
 — of the Dutch West Indies, 52
 — of the Far East, 53
 — of the Philippines, 191
 — of Venezuela, 603
 — Olaf Swartz's Types, 600
 — Relationship to Liverworts, 53
 — Scotch, 734
 — Spruce's South American, 52
 — Tropical American, Studies, 190
 Ferns, Tropical, New, 603
 — Varietal and Hybrid, Cytology, 189
 Ferraris, T., Italian Cryptogamic Flora, 354
 Ferro-silicon, 679
 Fertilisation and Gametophytes in Juniperus, 45
 — and Hybridisation in Ferns, 470
 — of Fern-prothallia, 189
 Fibres, Textile, Ultramicroscopic Examination of Colours, 770
 Fibrils, Connective-tissue, Origin and Structure of Embryonic Supporting Tissue, 298
 Ficus, Lithocysts, 466
 Ficaudt, H. v., Preparation and Staining of Neuroglia, 776
 Fiebigler, J., Miescher's Bodies, 730
 Figdor, W., *Dasygladus claviformis*, 616
 Filaria in Turkey's Eye, 722
 Filariæ in Ixodes, 317
 — Two, in Snake's Blood, 37
 Filassier, A., Microbes on Fruit, 86
 Filicales, Phylogeny, 469
 Filicean Petioles, Periderm-formation, 599
 Filon, L. N. G., Measurements of the Absolute Indices of Refraction in Strained Glass, 766
 Filters, Pringsheim's Yellow, 96
 Filtration of Immune Sera, 385
 Fin, Caudal, of Elopidae and some other Teleosteans, 449
 Finches, Peculiar Organ, 711
 Fine-adjustment, New, for Body and Substage of Microscopes, 535
 Fink, B., Lichens of Minnesota, 756
 Fischer, C. E. C., *Armillaria mucida*, 485
 Fischer, E., and another, Oak Mildew, 747
 Fischer, H., Adaptive Structure of Acera, 713
 — *Aspidium remotum*, 190
 — Gill of Bulleidae, 713
 — Media for Enumeration of Bacteria in Soil, 362
 — Recent Researches on Soil Bacteriology, 758
 Fish, Parasitic, New, 159
 — Salt-water, Tuberculosis, 497
 — Teleostean, Injecting Kidney, 378
 Fisher, W. K., New Starfishes, 321
 Fishes, Cyprinoid, Minute Structure of Food Canal, 20
 — from Irish Sea, Parasites, 581
 — Kidneys, 564
 — Mail-cheeked, Cranial Anatomy, 160
 — Oyster-eating, 711
 — Phosphorescent Organs, 21
 — Protozoan Parasites in Blood, 589
 — Studies, 24
 Fissidens, Some Irish Forms, 473
 Fitting, H., Epiphytic Lichens, 755
 Fixation of Celloidin Sections, 384
 Fixing and Imbedding Apparatus, Automatic, 774

- Fixing Plankton, New Method, 375
 Flagella and Minute Structure of *Spirillum volutans*, Methods of Demonstrating, 116
 — of *Spirillum volutans*, 88
 — of the Cholera Bacillus prepared by Löffler's Method, Measurement of the Diameter, 290
 Flagellate, Formation of Colonies, 741
 Flagellate of the Genus *Cercomonas*, Observations, 660
 Flagellates, *Leuvenia*, a New Genus, 614
 Flagellum of the Cholera Bacillus, Measurement, 270
 Flatters and Garnett, 533
 — — — Dissecting Tile and Stand, 522
 — — — "Firmax" Microtome, 665
 — — — Glycerin Jelly Bath, 524
 — — — Microscopical Slide Cabinets, 524
 Flea, Rat, Capable of Biting Man, 307
 Fleas, Rat, at Marseilles, 307
 Fleig, C., Vitality of Spermatozoa, 20
 Flemmings and Altmann's Granules, Identity, 671
 Flies and Typhus Fever, 453
 — as Disseminators of Typhus, 716
 — Chalcis, Seed-infesting, 31
 Flora, Cryptogamic, Italian, 354
 — Fungus, French, 356
 — Micro-fungus, of Central Russia, Contribution, 355
 — New, of Krakatau, 48
 — of Bremen, 621
 Floridæ, Secondary Attachment, 480
 — parasitic, 743
 — West Indian, 69, 480
 Flower-colour in *Antirrhinum majus*, Inheritance, 336
 — Physiological Interpretation, 337
 Flower-morphology and Embryology of *Datisca*, 183
 Fluid, Moss and other Objects mounted in, 800
 Fly, Candle, Structure, Habits and Life-history, 453
 Foex, E., *Oidiopsis taurica*, 75
 Foliage, Change in Direct Sunlight during its passage through, 333
Fomes lucidus, a Root-disease of Coconut palm, 485
 Fontinalis, Notes, 343
 Food Canal in Cyprinoid Fishes, Minute Structure, 20
 Foot, Supplementary Function in Yellow Races, 298
 Foraminifera, Arenaceous, New Genus, 589
 — Living, Collecting, 661
 — Recent and Fossil, of the Shore-sands of Selsey Bill, Sussex—V. The Cretaceous Foraminifera, 401; VI. A Contribution towards the Ætiology of *Massilina secans*, 693
 Ford, W. W., Distribution of Poisons in Mushrooms, 628
 Forel, A., Ants' Nests, 305
 Formalin for Preparation of Museum Specimens, 523
 Forti, A., Fresh-water Algæ from Ruwenzori, 64
 Foslie, M., Corallinaceæ, 71
 Foslie, M. H., 205
 Fossil Discoveries, New, and their Significance, 185
 Fowl Diphtheria, Microbe, 758
 — Domestic, Ligaments of Oviduct, 447
 — — — Reproduction, 556
 — — — Variation in Comb, 23
 — Leucocytozoon, 327
 — Microfilaria, 36
 — Spermatogenesis, 19
 — Unfertilised Egg, Segmentation, 442
 Fowl-septicæmia, New Bacillus, 364
 Fowls, Hyperdactylism, 20
 França, C., Piroplasmidæ, 730
 François-Franck, C. E., Mechanism of Respiration in Lizard, 158
 Frankel, E., *Bacterium anthroposepticum*, 637
 Franz, V., Photography with Ultra-violet Light, 766
 Fraser, H. C. I., Cytology of the Ascus, 74
 Free-martin, Reproductive Organs, 296
 Freeman, D. L., Stroma-formation in *Xylaria Hypoxyylon*, 483
 Freidsohn, A., Blood of Amphibians, 446
 Freidsohn, F., Studying the Morphology of the Blood of Amphibia, 383
 Freiling, H. H., Odoriferous Organs in Female Lepidoptera, 165
 Friction, Internal, of Solids at Low Temperatures, 530
 Friedrich, K., Nickel-carbon Alloys, 525
 — Novel Application of Alloys, 530
 Fritsch, F. E., Fresh-water Algæ in Nature, 199
 — Phylogeny and Inter-relationship of the Green Algæ, 742
 Fritz, F., Vibrissæ on Cat's Arm, 157
 Frog, Abnormal Reproductive Organs, 19
 — New Trematode, 459
 — Seasonal Migration of Fat, 24
 Frog's Circulation, Abnormalities, 449
 Fromme, W., *Pulex cheopis* in Hamburg Docks, 31
 Frosch, P., *Bacillus septicæmiæ anserum exsudativa*, 90
 Fronin, A., Cultivating *Bacillus tuberculosis*, 521
 Frugoni, C., Cultivation of the Tubercle Bacillus upon Animal Tissues, 375
 Frühwald, —, Indian-ink Method of Demonstrating *Spirochaeta pallida*, 386
 Fruit, Microbes on, 86

- Fruit- and Seed-development, Influence of Light, 593
- Fruit-trees, Mycorrhiza, 493
- Frullania, European, New, 342
- Frye, T. C., Polytrichaceæ of Western North America, 738
- Fuchs, H., Homologies of Mammalian Pterygoid, 447
- Morphological Significance of Sacral Ribs, 157
- Temporal Region in Vertebrates, 157
- Fucoid, Fossil, New, 622
- Fucus, Hybrid, 196
- *vesiculosus*, Cryptostomata and Concomitantes, 743
- Fuhrman, F., Flagella of *Spirillum volutans*, 88
- Methods of Demonstrating the Flagella and Minute Structure of *Spirillum volutans*, 116
- Fuhrmann, O., Hermaphroditism in Toads, 296
- Fukuda, T., Japanese Stomatopods, 456
- Fulinski, B., Development of *Agelastica alni*, 308
- Fulmek, L., *Gossyparia ulmi* on Mistletoe, 165
- Funaria hygrometrica*, Life-history, 55
- Funck, C., Device for Protecting Mounted Sections during Dehydration, 257
- Theory and Practice of Sharpening Razors, 777
- Fungi, Ambrosia, 492, 629
- Argentine, 355
- Atlas, 211
- Biological Experiments, 212
- Breaking up of Cyanamides, 487
- Chilian, 628
- Development on Fatty Substances, 73
- Edible, 751
- Fermentation, from Korea, 354
- Ferments, 212
- Filamentous, Freezing, 79
- Fumagine, Study, 750
- Genera, 79
- Higher, Experiments, 353
- Irish, Catalogue, 629
- Larger, Notes, 77, 209, 352, 486, 628, 749
- — of Rhine-land, 211
- Lower, Evolution, 72
- New or Critical, 486
- Nuclear Phenomena of Sexual Reproduction, 751
- of Brandenburg, 209
- of Termites' Nests, 354
- of the Clyde Area, 487
- Pathogenic, 356
- Plea for the Study, 750
- Poisonous, 355, 751
- — and Edible, 211
- Popular Account, 750
- Protection of Shade Trees against Attacks, 354
- Fungi, Pyrophilous, Studies, 623
- Rust, Sexuality, 484
- Servian, 628
- Torula, Study, 625
- Wood-destroying, 748
- See CONTENTS
- Fungose and Callose, Relations, 751
- Fungus, a New Koji, *Rhizopus Batatas*, 72
- Cell-sap, Chemical Study, 212
- Chytridiaceous, New, 622
- Entomogenous, Important, 626
- Flora, French, 356
- — German, 749
- Parasites of Algæ, 73
- Spores, Wintering, 355
- Fungus-culture and Termites, 79
- Fungus-flora, German, 211
- Funnel, New Hot-water, 246
- Fusulinidæ, Structure and Life-history, 464
- G
- Gaetgens, W., Comparative Value of recent Typhoid Culture-media, 375
- Gaertner, A., Disease of Sheep caused by a Lanceolate Diplococcus, 636
- Gaertner Group of Bacilli, Relation of the Ratin-bacillus, 89
- Gage, G. E., Biological and Chemical Studies on Nitroso-bacteria, 635
- Gagneux, C., Leuco-reaction in Pregnancy, 296
- Gaidukov, N., Dark-field Illumination and Ultramicroscopy in Biology and in Medicine, 367
- Galiano, E. F., Spiders of Spain, 454
- Gall-bladder, Double, in Cat, 711
- of Dog, Glands, 447
- Gall-fly, Gametogenesis, 569
- Gall-mite, New, on Hawthorn, 454
- Gallardo, A., Modern Study of Heredity, 557
- Theory of Cell-division, 445
- Galleotti, G., Bacterial Flora in the Ice of Monte Rosa, 361
- Galli-Valerio, B., Germs in Mountain Air, 636
- Indian-ink Method in Parasitology, 785
- Galls, Argentine, 714
- Galvanised Metals, Testing, 124
- Gamble, F. W., Light and Pigment-formation in *Crenilabrus* and *Hippolyte*, 719, 773
- Gametogenesis of Gall-fly, 569
- Gametophore and Sporogonium of *Conoccephalum*, 53
- Gametophyte of *Onoclea*, Sex, 733
- Gametophytes and Fertilisation in *Juni-perus*, 45
- Ovule and Embryo of *Widdringtonia*, 46
- Gammarids, Eyes, 313
- Gammarus, Agglutination of Blood Corpuscles, 313

Gaumarus, Blood-coagulation, 719
 Ganglion-cells, Internal Reticulum, 446
 Ganong, W. F., Balls of Vegetable Matter from Sandy Shores, 49
Ganymedes anaspidis, Collecting and Examining, 373
 Garbowski, T., Experiment with Sea-urchin Ova, 584
 Gardner, N. L., *Leuvenia*, a New Genus of Flagellates, 614
 Garjeanne, A. J. M., Luminosity of Moss Leaves, 606
 Gases, Cementation, 791
 — Occluded in Steel, 124
 Gassi, D., New Staining Reaction for Tubercle Bacilli, 117
 Gastropod Foot and Branchial Cavity, 566
 Gastropoda. See CONTENTS
 Gastrulation and Segmentation in Lamprey, 443
 Gates, R. R., Chromosomes in *Oenothera*, 43
 — Litter of Hybrid Dogs, 153
 Gauthier, J. C., Rat-flea capable of Biting Man, 307
 — Rat-fleas, 571
 — at Marseilles, 307
Gebia deltura and *Upogebia stellata*, 456
 Gecko, Trypanosome, 326
 Geddes, A. C., Development of Penguin, 444
 Geheeb, A., Mosses of the Rhöngebirge, 194
 — Necrology, 61
 Geiger, A., Study of *Torula Fungi*, 625
 Gelatin Plates for Graphic Reconstruction, 787
 Gelderd, C., Digestive System of Schizopods, 169
 Gemelli, A., Innervation of Tympanum, 154
 Gemme, Discoid, in Foliose Hepatics, 604
 Gemmill, J. F., Adaptation of Ordinary Paraffin Baths for Vacuum Imbedding, 805
 — Aerator for Small Aquaria, 805
 — An Automatic Aerating Apparatus for Aquaria, etc., 9, 127
 Genera, New—
 Botany:
 Agyrona, 78
 Agyronella, 487
 Apiosphæria, 487
 Articularia, 78
 Bombardiella, 487
 Chætasterina, 753
 Chætodiscula, 493
 Chromocrea, 351
 Chromocreopsis, 351
 Coccochora, 487
 Coronophorella, 487
 Costarcia, 191
 Cryptoascus, 215

Genera, New (*Botany*) cont.—

Currانيا, 191
Cyclodomus, 487
Cystopsora, 748
Diachæella, 78
Dimerosporiella, 487
Diplosphaera, 202
Dyctionella, 78
Eucapsis, 205
Franciella, 613
Gracilariophila, 744
Heteroschyphus, 607
Hyalosiphonia, 199
Hydropterangium, 598
Hysterodothis, 487
Lecideopsisella, 487
Lepidodermopsis, 78
Leuvenia, 614
Linodochium, 487
Lophodermopsis, 628
Monochytrium, 481
Mycoglena, 487
Myriophysella, 628
Northoravenelia, 631
Paranthostomella, 628
Phæochora, 487
Phæodomus, 487
Phæoisaria, 78
Physalosporella, 628
Physarina, 78
Placynthiella, 218
Polymerodon, 195
Protophallus, 210
Pseudolachnea, 629
Pseudoracelopus, 738
Pseudorhynchia, 487
Pyramidochrysis, 203
Ranojevica, 629
Rehmiellopsis, 215
Sclerophoma, 487
Scolecopeltopsis, 78
Simplicidens, 195
Sirozythiella, 487
Sphæronemopsis, 628
Stemphyliopsis, 628
Treubiomycetes, 487
Tuberculariopsis, 78
Valetoniella, 487
Volutellopsis, 628
Wollnya, 195
 Zoology:
 Actinothrips, 167
 Aeschnasoma, 452
 Ammodiscoides, 589
 Analocostreptus, 310
 Anactinothrips, 167
 Astrorrhombus, 175
 Barella, 717
 Batillipes, 173
 Bothriomolus, 318
 Cactogorgia, 178
 Chuneola, 34
 Comatilia, 586

Genera. New (*Zoology*) cont.—

- Cryptopteromyia, 32
 Dactylophrya, 326
 Dendrogorgia, 323
 Eliotia, 26, 566
 Ellipsoidina, 410, 414
 Eurychilum, 325
 Evulisoma, 310
 Ganymedes, 373
 Gephyreaster, 321
 Grantilla, 178
 Helicoeranchia, 451
 Heterozonias, 321
 Hicksonella, 681
 Investigator, 579
 Kebira, 178
 Kolostoneura, 38
 Lamprodermopsis, 360
 Lysaster, 461
 Menginilla, 310
 Metamera, 659
 Metriostreptus, 310
 Microphasma, 34
 Mimonecteola, 34
 Neopelagia, 727
 Neotetracus, 157
 Nuttallia, 730
 Orthocona, 325
 Pentapycnon, 717
 Pericambala, 168
 Protopteron, 32
 Ptilocodium, 323
 Rhabidostreptus, 310
 Rhynchophrya, 326
 Scelerella, 585
 Scolionema, 727
 Sidneioides, 25
 Smithia, 730
 Sphæriodiscus, 321
 Stempellia, 465
 Studeria, 178
 Telomyxa, 465
 Thaumatocephalus, 727
 Thrissacanthias, 321
 Typhlocaris, 313
 Urashimea, 727
 Urophiala, 352
 Zoomyxa, 42
 Generation-cycles in Cladocera, 34
 Genital Apparatus of Neuroptera, 309
 — Ducts of *Helix pomatia*, Abnormalities, 303
 Gentian-violet, Stable Solution, 787
 Genus *Ceratocorys*, Revision, 729
 — New, of Arenaceous Foraminifera, 589
 — — of Flagellates, Leuvenia, 614
 — — of Solifugæ, 717
 — — of Unstalked Hydroids, 586
 Geophilomorpha, Classification, 168
 Georgevitch, J., Alimentary Tract and Habits of *Simulium columbacensis*, 306
 — New Trypanosome, 41
 Georgevitch, P., Apospory and Apogamy in Trichomanes, 187, 734
 — Desmids from Macedonia, 347
 — New Species of Thermophilic Bacilli, 500
 — Serbian Desmids, 347
 Georgi, W., Measuring Inclination of Abbe's Drawing Apparatus, 761
 Geotropism and Growth in Length of *Coprinus stiriacus*, 485
 Gephyrean Type, New, 579
 Gepp, A., Bryophyta of Fiji, 60
 Gérard, P., Spermatogenesis in *Stenobothrus biguttulus*, 32
 Gerber, C., Chemical Study of Fungus Cell-sap, 212
 Gerhardt, U., Os Penis and Os Clitoris in Apes, 299
 Germ-cells, Primitive in Sagitta, 170
 Germain, L., Malacology of Equatorial Africa, 26
 Germination of *Salvinia natans*, 51
 Germs in Mountain Air, 636
 Gerth, H., Fossil Corals from Ceram, 324
 Gessard, C., New Method of Preparing Culture Media, 663
 Gibson, W. T., Hypochord in Skate Embryos, 152
 Giemsa, G., Staining Moist Preparations and Sections by the Azur-eosin Method, 522
 — — Wet Films by Giemsa's Azur-eosin Method, 784
 Giemsa's Azur-eosin Method, Staining Wet Films, 784
 Giesen, W., Special Steels, 120
 Giesenhagen, K., Types of Tropical Mosses, 606
 Gifford, J. W., Additional Refractive Indices of Quartz, Vitreous Silica, Calcite and Fluorite, 766
 Gil, A. C., Spanish Bryophytes, 610
 Gill of Bulleidæ, 713
 Gineste, C., Cytoplasmic Fibrillation of Chilomonas, 729
 Gins, A. A., Burri's Indian-ink Method, 118
 Giolitti, F., Cementation of Steel, 527
 — Copper-tin Alloys, 119
 — Corrosion of Bronzes, 676
 — Lead Bronzes, 526
 — Use of Metallic Deposits in Metallography, 123
 Gissing, C. E., Spark Spectra of the Metals, 793
 Glaeser, K., Cartilage of Regenerated Amphibian Extremities, 297
 Glaesner, L., Segmentation and Gastrulation in Lamprey, 443
 Glanders, Fixation of the Complement, 87
 Glands in Caterpillars, 572
 — Thoracic, in Caterpillars, 305
 Glass, Optical, Homogeneity, 244

- Glass, Varieties, Micro-chemical Tests for Identification, 768
Gleotheca rupestris, 478
 Glow-worm, Luminosity, 166
 Glowacki, J., Muscineæ of the Julian Alps, 344
 Glycerin Jelly Bath, 524
 Glycerin-agar in Fifty Minutes, 248
 Glycogen, Methods of Staining, 381
 — of Muscle, 446
Gnomonia erythrostoma, Development, 745
 Goddard, E. J., Australian Fresh-water Polyzoa, 320
 — — Hirudinea, 316, 458
 — Polyzoon on Pontobdella, 460
 Goebel, K., *Monoselenium tendrum*, 474
 Goerens, P., Influence of Antimony and Tin on the Iron-Carbon System, 679
 Goggio, E., Experiments on Tadpoles, 557
 Gogorza, J., Skin of Pleurodeles, 445
 Gold Leaf, Properties at High Temperatures, 387
 Goldschmidt, R., Nervous System of *Ascaris*, 170
 Golgi's Method, Fluoride of Silver in, 256
 — — for Examining the Internal Network of Spinal Marrow Cells, 384
 Gonder, R., Peculiar Trematode of the Mole, 318
 Gonidia and Hyphæ in Lichens, Relation between, 494
 — Variation in Genus *Solorina*, 755
 Gonionemus, Light Reactions, 727
 Goodey, T., Skeleton of Frilled Shark, 712
 — Vestiges of Thyroid in *Chlamydoselachus* and Dog Fish, 562
 Goodrich, E. S., Nephridia of *Dinophilus* and of Larvæ of *Polygordius*, *Echiurus*, and *Phoronis*, 316
 — Origin of Vertebrata, 447
 — Segmental Structure of Motor Nerve Plexus in Elasmobranchs, 449
 Gooseberry Bushes, Two Diseases, 488
 Gorboff, A., Invariant Systems and the Composition of Eutectics, 528
 Gordius, Structure, 317
 Gordon, W. T., Fossil Osmundaceæ and Zygopteridæ, 596
 Gorgonellid Genus, New, *Hicksonella*, 681, 796
 Gorgonellidæ, Revision, 727
 Gorgonia, Unknown Species, 800
 Gorini, C., Rennet-forming Cocci in Cheese, 757
 Goris, M. A., Anatomical Study of the Mangifereæ, 590
 Gorodkova, A., Method of Obtaining Yeast-spires, 520
Gossyparia ulmi on Mistletoe, 165
Gracilaria confervoides, New Parasite, 619
 Graff, L. v., North American Turbellarians, 382
 Graft-hybrids, Characters, 335
 Graft-hybrids, Guinea-pig, 705
 Graham, M., Sporogonium and Gametophore of *Conocephalum*, 53
 Gram's Method of Staining, Chemical Basis, 381
 — — — Modification, 118
 Grandjean, M., Edible Fungi, 751
 Granules, Flemming's and Altmann's, Identity, 671
 — in Nerve-cells, 445
 Grard, —, Brass and Copper, 119
 Grating, Plane, An Adjustment for, similar to Rowlands Method for the Concave Grating, 105
 — Use in Interferometry, 764
 Gratings, Glass and Metallic Replicas, 763
 Gravet, P. J. F., 739
 Gravier, C., *Madreporaria* of the Gulf of Guinea, 726
 — Peruvian Polychæts, 35
 Grayson, H. J., On the Production of Micrometric and Diffraction Rulings, 239
 Grayson, S. A., Case-hardening, 790
 Grayson's Finest Twelve-band Plate, on the Measurement of the First Nine Groups, 144, 267
 — Photomicrographs of his Rulings, 701
 — Photographs of 100,000, 110,000 and 120,000 Rulings of 12-band Plate, 801
 — Rulings, 533
 — Ten-band Plate, on the Measurement, 5, 126
 Grebe, C., New German Mosses, 56
 Greenwood, H. C., Influence of Pressure on the Boiling-points of Metals, 531
 Greenwood, H. E., and others, North American Bryophyta, 194
 Gregarine, New, *Metamera schubergi* g. et sp. n., Observations, 659
 Grégoire, V., Phenomena of Synaptic Phase, 154
 Gregory, J. W., Cretaceous Bryozoa, 460
 Gregory, R. P., Histology of Giant and Ordinary *Primula sinensis*, 331
 Greig-Smith, R., Bacterial Flora of Rachitic Stools, 757
 — Slime Bacteria on Sponges, 757
 Grenet, —, Hardness of Steel, 123
 — Transformations of Iron and Steel, 123
 Grenet, L., Cementation of Silicon Steels, 391
 Grieve, S., Marine Algæ of Dominica, 199
 Griffith, C., Cementation by Carbon, 122
Griffithsia Bornetiana, 70
 Griffon, —, Oak Mildew, 482
 — Plant Diseases, 356
 Griggs, R. F., Mitosis in *Synchytrium*, 43
 — New Genus of Chytridineæ, 481
 Grobéty, A. E., *Ourococcus bicaulatus*, 203
 Groschuff, E., Micro-chemical Tests for Identification of Varieties of Glass, 768

- Groselj, P., Nervous System of Anemones, 176
- Grouse, Ectoparasites and Endoparasites, 167
- Parasites of Birds allied to, 172
- Red, Nematodes, 171
- — Tapeworms, 172
- Grout, A. J., North American Moss Book, 611
- and others, North American Species of *Amblystegium*, 58
- Grove, W. B., Mycetoza of the Midland Plateau, 634
- Growing Azotobacter in Large Quantities for Chemical Analysis, Two New Methods, 109
- Growth of *Amanita*, Influence of Gravity, 334
- “Growth” of Cast Irons after repeated Heatings, 390
- Growth of Seed Plants. See CONTENTS
- Grynfeldt, E., Tensor Muscle of Choroid in Teleosteans, 449
- Guéguen, F., Brother’s Crown, 204
- Notes on the Larger Fungi, 352
- Poisonous and Edible Fungi, 211
- Guerbet, M., Chemical Basis of Gram’s Method of Staining, 381
- Guertler, W., Alloys of Tin and Lead, 260
- Bearing-metals and Stamped Alloys, 789
- Lead-tin Alloys, 525
- Guglielmetti, G., Protococcaceæ, 202
- Guieysse-Pellissier, A., Polynuclear Ovum in Bat, 294
- Guillemond, A., Resistance of various Bacteria to Alterations in Osmotic Pressure, 222
- Guillemin, H., French Fungus Flora, 356
- Guillet, L., Cementation by Carbon, 122
- Heat Treatment of Special Steels, 791
- Thermal Treatment of Cemented Steel, 791
- Zinc Bronzes, 677
- Guilliermond, A., Critical Notes on Yeast Researches, 483
- Cytology of Yeasts, 351
- Fusion of Yeast-cells, 624
- Notes on Yeast-cells, 747
- Study of Endomyces, 206
- Notes on Phylogeneses in Yeasts, 75
- Guinea-pig Graft Hybrids, 705
- Guinet, A., Geneva Mosses, 738
- Mosses of Savoy, 194
- Guitel, F., Kidneys of Fishes, 564
- Gulia, G., Pteridophyta of Malta, 190
- Gum-flow in Relation to Anatomy in Bromeliaceæ, 182
- Gut, Minute Structure, in *Chrysopa perla*, 309
- Guthrie, C. C., Engrafting Gonads, 705
- — Tissues, 705
- Guthrie, C. C., Guinea-pig Graft Hybrids, 705
- Gutowski, N., Iron-carbon Alloys, 390
- Gutwinski, R., Algæ of the Tatra Mountains, 621
- Guye, C. E., and others, Internal Friction of Solids at Low Temperatures, 530
- Guyer, M. F., Plumage of Hybrids between Guinea Fowl and Fowl, 444
- Spermatogenesis of Fowl, 19
- Gwynne-Vaughan, D. T., Fossil Osmundaceæ, 595
- Gymnophiona, Development of Head, 19
- Györfy, I., Mosses of Hungary, 57
- *Pohlia carnea* in Transylvania, 609
- Some Bryological Rarities, 60

H

- Habenaria, Embryo-sac, 47
- Habits of American Toad, 300
- of *Æcophylla smaragdina*, 304
- Hachlov, L., Body-wall of Leeches, 579
- Hadzi, J., Nervous System of Hydra, 175
- Hæmatin Stains, 786
- Hæmocœle in Dinophilus, 460
- Hæmogregarina sebai*, Endogenous Multiplication, 730
- Hæmogregarines in Australian Reptiles, 327
- Hæmoproteus orizivoræ*, 39
- Hæmoprotozoa in Birds of New South Wales, 40
- Hagen, I., Norwegian Moss-flora, 56
- *Orthothecium strictum* or *O. rubellum*, 343
- Hagmann, G., Reptiles of Mexiana, 300
- Hailstone, G., Structure of Cast Iron, 263
- Hairs on Mole’s Hands and Feet, 710
- Haken, W., Thermo-electric Properties of Metallic Alloys, 529
- Halbert, J. N., Irish Neuroptera, 166
- Halla, Fibres of, and Giant Nerve-cells, 457
- Halle, B., Method of Estimating the Hardness of Minerals, 259
- Halle, T. G., Sagenopteris and Hydropterangium, 598
- Hallez, P., Fresh-water Nemerteans, 460
- New Type of Turbellarian, 318
- *Paravortex cardii*, 171
- Protective Encystation of Fresh-water Nemertean, 319
- *Sagitta inflata*, 36
- Summer and Winter Spawning in a Fresh-water Nemertean, 320
- Halopteris scoparia* and *Sphacelaria radicans*, 67
- Halos, Pleochroic, 243
- Hamerton, A. E., Amakebe and East Coast Fever, 326

- Hammer, B. W., Two New Methods for Growing Azotobacter in large quantities for Chemical Analysis, 109
- Hammer, E., Development of *Sycon raphanus*, 324
- Hammerschmidt, J., Development of Plasmatidæ, 571
- Hamster, Mouth and Pharynx, 564
- Handswaldt, H., Axial Images of Fluid Crystals, 658
- Hansen, F. C., Monochromatic Illumination, 514
- Hansen, H. J., Antarectic Schizopods and Cumacea, 575
- Hanson, E. K., Phycoerythrin, 195
- Hard, M. E., Mushrooms, Edible and otherwise, 78
- Hardening and Imbedding the Eggs of *Temnocephala fasciata*, 114
- Harder, E., *Xylaria Hypoxylon*, 350
- Harding, C. F., Use of the Polariscopes in Testing High-tension Insulators, 98
- Harding, W. A., New Leeches from Ceylon, 170
- Hardness of Minerals, Method of Estimating, 259
- of Quenched Steels, 391
- Hare and Rabbit, 710
- Hargitt, C. W., Spawning of *Hydroïdes dianthus*, 721
- Hargitt, G. T., Collecting Cœlenterata and Observations on the Ova, 112
- Harmand, —, Lichens from Greece, 84
- Harms, W., Postembryonic Development of Unionidæ, 164
- Harper, R. A., Nuclear Phenomena of Sexual Reproduction in Fungi, 751
- Harpidium, Belgian Forms, 474
- Harries, E. H. R., Detection of Tubercle Bacilli in Milk and Fœces, 782
- Harrison, R. M., Madreporaria from Mergui, 463
- Hart, D. B., Reproductive Organs of Free-Martin, 296
- Hashegawa, T., Life-history of *Schistosomum japonicum*, 459
- Hastatella ralians*, 589
- Haswell, W. A., Hardening and Imbedding the Eggs of *Temnocephala fasciata*, 114
- Hate, V. N., Bombay Characeæ, 743
- Hatschek, B., Metamerer of Petromyzon, 152
- Hayhurst, —, Staining Blood Smears, 785
- Haynes, C. C., Abbé Charles Lacouture, 195
- Sphærocarpos, 474
- and others, North American Bryophytes, 475
- Hayrén, E., Finland Algæ, 72
- Head of Gymnophiona, Development, 19
- Heald, F. D., Systematic Position of *Urnula Geaster*, 350
- Heald, F. D., Whitening of the Mountain Cedar, *Subina sabinoides*, 746
- Heart in Teleosts, Development, 18
- Heart-action in Fish Embryos, Study, 160
- Heart-muscle, Examining the Structure, 252
- Structure, 297
- Heat Microscope, New, 366
- Heat-capacity of Metals and Compounds, 793
- Hebb, R. G., 127, 128, 267, 270, 272, 393–395, 399, 400, 533–535
- Hecke, —, Smut Infection of Wheat and Barley, 76
- Hedgehog, Immunity, 448
- Piroplasma, 180
- Heen, P. de, Phenomena of Light-polarisation in Solid and Pseudo-liquid Organised Matter, 518
- Hegner, R. W., Effect of Centrifugal Force upon Eggs of Chrysomelid Beetles, 308, 715
- Heiderich, F., Visible Centrosomes in Living Cells, 558
- Heidsieck, —, Cultivation of *Oidium albicans* from Throats, 375
- Heilbron, A., Apogamy, Hybridisation, and Heredity in certain Ferns, 470
- Heinrich, G., Studying the Development of Dentine in Mammalia, 258
- Heinrich, O., Development of Dentine in Mammals, 557
- Heinricher, M. E., Germination of Seeds of Parasitic Plants, 332
- Held, H., Studying the Finer Structure of the Labyrinth of Vertebrata, 113
- Helicidæ, Classification and Distribution, 163
- Heliözoon, New, 179
- Helix pomatia*, Abnormalities in Genital Ducts, 303
- Spermatogenesis, 303
- Helminthostachys, Suspensor, 596
- Helvella elastica*, Development, 350
- Hemileia vastatrix*, Germination of Uredospores, 626
- Hemiptera Injurious to Cocoa, 716
- Hendersonia, Systematic Study, 625
- Henker, O., Binocular Loups of Weak and Medium Magnification, 225
- Henry, A., Genus Onchocerca, 317
- Nematodes of the Eye, 317, 458
- Hepaticæ, Distribution in Scotland, 736
- European, 737
- Mexican, 59
- Monograph, 55
- of Hamburg, 194
- of Madeira, 476
- of New England, 59
- Protonema and Propagules, 605
- Regeneration, 472
- Scottish, 609
- Hepatics and Contamination, 614

- Hepatics, European, 611
 — Foliose, Discoid Gemmæ, 604
 — Lancashire, 610
 — of Eisenach, 57
 — of the Haute-Saône, 56
 Herdman, W. A., Antarctic Tunicata, 302
 — Intensive Study of Plankton around South End of Isle of Man, 562
 Heredity, Apogamy and Hybridisation, in certain Ferns, 470
 — in Connection with Cancer, 705
 — Influence of Male Parent, 296
 — Modern Study, 557
 — Role of the Nucleus, 442
 Herelle, F. d', Two Filariæ in Snake's Blood, 37
 Héribaud, J., Fossil Diatoms, 202
 Hermaphroditism among Free-living Nematodes, 722
 — in *Crepidula fornicata*, 163
 — in Toads, 296
 — of *Prosochmus claparedi*, 725
 — Protandrous, in Lernæopodidæ, 720
 Hermit-crabs and Sea-anemones, Commensalism, 718
 — Ceylonese, Notes, 719
 Heron-Allen, E., 134, 136, 534, 805
 — Collecting Living Foraminifera, 661
 — Foraminifera from Selsey Bill, 125
 — On the Recent and Fossil Foraminifera of the Shore Sands of Selsey Bill, Sussex—V. The Cretaceous Foraminifera, 399, 401; VI. A Contribution towards the Ætiology of *Massilina secans*, 693
 — Some Varietal Forms of *Massilina secans*, 796
 Herpell, G., Larger Fungi of Rhine-land, 211
 Herter, W., New Species of Lycopodium, 51
 Hertwig, O., Role of Nucleus in Heredity, 442
 Herwerden, M. A. v., Structure of Nucleus in Cells of Salivary Glands of Chironomus Larvæ, 452
 Herzog, A., Diagnosis of Natural and Artificial Silks, 659
 Herzog, T., Bolivian Mosses, 194
 — Mosses of New Guinea and the Molluscs, 59
 — Rare European Mosses, 611
 Hesse, E., Cnidosporidia in Mayfly Larvæ, 465
 Hessian Fly. On the Life-history, with Notes on the Tenby Wheat Midge, 127
Heterocladium Macounii, 474
 Heteroschlyphus and Chiloschlyphus, 607
 Heterospory in Marsilia, Origin, 188
 Hewitt, C. G., Bionomics of the House Fly, 567
 Heyder, P., Development of Pulmonary Cavity in Slug, 25
 Hicken, C. M., Ferns of Argentina, 603
 Hickson, S. J., New Species of Stachyodes, 177
 "Hicksonella," a New Gorgonellid Genus, 681, 796
 Hill, B. P., Copper-arsenic Alloys, 676
 Hill, John, M.D., An Eighteenth Century Microtome, 779
Hillhousia mirabilis, 87
 Hilton, A. E., British Mycetozoa, 802
Himanthalia lorea, 618
 Himmelbauer, W., Flower-morphology and Embryology of *Datisca*, 183
 Hindle, E., Staining *Trypanosoma dimorphon*, 672
 Hippolyte and Crenelabrus, Light and Pigment-formation, 719
 — *gracilis* in the British Area, 168
 Hirschler, J., Development of Mid-gut in a Beetle, 30
 Hirsh, P. E., Development of Air-chambers in Ricciaceæ, 340
 Hirst, S., New Genus of Solifugæ, 717
 Hirudinea, Australian, 316, 458
 — Musculature, 35
 Hirzel, H., Abortive Embryo of *Salamandra atra*, 152
 Histology of Metamorphosis, 306
 — of Vertebrata. See CONTENTS
 Hive-bee, Brain, 164
 Hjort, J., 'Michael Sars' North Atlantic Deep Sea Expedition, 772
 Hoche, L., Affinities of Mammary Glands, 709
 Hodgson, T. V., Antarctic Isopods, 457
 Hofeneder, K., New Strepsipteron, 310
 Hoffman, C., Two New Methods of Growing Azotobacter in Large Quantities for Chemical Analysis, 109
 Höhnel, F. v., Mycological Fragments, 78
 — — Notes, 211
 — New or Critical Fungi, 486
 Holden, H. S., Note on a Wounded Myeloxylon, 599
 — Periderm-formation in Filicinean Petioles, 599
 Hollick, A., New Fossil Fucoid, 622
 Hollnagel, H., Measurements in the Long-waved Spectrum, 517
 Hollrung, M., Review of Plant Diseases, 629
 Holmes, E. M., British Algæ, 346
 — — Marine Algæ, 199
Holothuria floridana, Development, 174
 — *forskali* in Scottish Waters, 462
 Homogeneity of Metals, 529
 — of Optical Glass, 244
 Honey-bee, Study, 568
 Honey, R., Suctorial Disc of Echeinis, 301
 Hood, O., New Chytridiaceous Fungus, 622
 Hoogenraad, H. R., New Heliozoon, 179
 Hop Pests, 33

- Hopkins, L. S., New North American Ferns, 602
- Hopkinson, J., 134
- Horand, R., Influence of Ultra-violet Rays on Trypanosomes, 464
- Horn, P., Species of *Tylenchus* in Moss, 458
- Hornell, J., New Species of Pinnoteretes, 168
- Hornycold, A. G., Gemmiform Pedicellariæ, 461
- Hornycold, H. A. G., Mode of Feeding in *Echinocardium* and *Spatangus*, 174
- Horse, Development of Auditory Ossicles, 150
- Horses, Restoration of Ancient British Race, 299
- House-fly, Bionomics, 567
- Houssay, F., Asymmetry of Cetacean Skull, 299
- Hoven, H., Role of Chondriome in Secretion, 709
- Howard, J. E., Tests of Ingots, 263
- Howe, H. M., Closing of Blowholes in Steel Ingots, 263
- Metallography of Iron, 122
- Howe, M. A., Algæ of Panama, 620
- Marine Algæ of Panama, 345
- West Indian Marine Algæ, 346
- Howorth, H. H., History of *Mya arenaria*, 566
- Hoyle, W. E., Catalogue of Recent Cephalopods, 162
- Hoyt, W. D., *Dictyota dichotoma*, 197
- Fertilisation and Hybridisation in Ferns, 470
- Hudson, O. F., Phosphor-bronze, 676
- Hue, —, Variation of Gonidia in the Genus *Solorina*, 755
- Huet, R. H. J. G., Seminal Vesicles and Infection, 158
- Huggins, Sir William, Death of, 399
- Donation, 393
- Huie, L. H., Mast-cells and Plasma-cells, 155
- Hulanicka, C., Nerve-Endings in Frog's Skin, 297
- Humfrey, J. C. W., Crystalline Structure of Iron at High Temperatures, 389
- Husnot, T. A. Geheeb: Necrology, 61
- P. J. F. Gravet, 739
- Huss, H., New Bacillus in Cheese, 221
- Hustedt, F., Flora of Bremen, 621
- Huxley, J. S., Collecting and Examining *Ganymedes anaspilis*, 373
- Hybrid Dogs, Litter, 153
- Hybridisation and Fertilisation in Ferns, 470
- Apogamy and Heredity in certain Ferns, 470
- in *Mirabilis*, 336
- of Wolf and Dog, 444
- Hybrids between Guinea Fowl and Fowl, Plumage, 444
- Hydatina senta*, Life-cycle, 583
- Hydra, Cnidoblasts, 176
- Nervous System, 175
- Hydrachnids, New, 573
- Hydrocoralline from Rockall, 324
- Hydroid, Hydroid Parasite on, 39
- New Gymnoblasiæ. Epizoic on a Penantulid, 323
- Hydroides dianthus*, Spawning, 721
- Hydroids, British Museum, Revision, 464
- Budding and Shoot-formation, 175
- Ontogeny and Phylogeny, 585
- Two Unrecorded 'Challenger,' 463
- Unstalked, New Genus, 586
- Hydropterangium and Sagenopteris, 598
- Hymenophyllaceæ, Stegmata, 187
- Hymenophyllum peltatum* in Yorkshire, 601
- Hymenoptera, Mouth-parts of Wasps and other, 164
- Parasitic, from the Tertiary of Florissant, 165
- Hymenopterous Parasites, Studies, 27
- Hyobranchial Skeleton in *Salamandra atra* and *Triton alpestris*, Development, 152
- Hyperdactylism in Fowls, 20
- Hyphæ and Gonidia in Lichens, Relation between, 494
- Hyphomycetes, 75, 352, 483, 626
- Classification, 351
- Hypochoerid in Skate Embryos, 152
- Hypocreales, American, III., 350
- North American, 624
- Hypophysis, Human. Process of Secretion, 709
- Nucleated Red Blood Corpuscles in Blood-vessels, 707

I

- Icthyosporidian Disease in Sea Trout, 181
- Ignatowsky, W. v., Improvements in the Leitz Mirror Condenser, 761
- New Nicol for Projection Purposes, 652
- Ihering, H. v., Classification and Distribution of Helicidæ, 163
- Ikeda, I., New Japanese Corymorpha, 464
- Ilkewitsch, K., and others, Wood-destroying Fungi, 748
- Illing, G., Minute Structure of Tonsils, 446
- Illuminating and other Apparatus. *See* CONTENTS
- Illumination, Axial Cone, in Photomicrography, Method of Estimating the Exposure, 369
- Dark-field, and Ultramicroscopy in Biology and in Medicine, 367
- Observations on Mammalian Blood, 108
- Dark-ground, 98
- with High Powers, 764
- Monochromatic, 514

- Imbedding and Fixing Apparatus, Automatic, 774
- and Hardening the Eggs of *Temnocephala fasciata*, 114
- Objects. *See* CONTENTS
- Paraffin in Vacuo, Simple Method, 255
- Vacuum, Adaptation of Ordinary Paraffin Baths, 805
- Inms, A. D., New Scutigera, 33
- Immunity of Hedeghog, 448
- Incertæ Sedis. *See* CONTENTS
- Index Numbers, Selection. Use of in Breeding, 296
- Refraction, of Liquids, Measurement by the Microscope, 243
- Refractive of Canada Balsam, 372
- — of Opaque Bodies. New Form of Polarimeter for the Measurement, 93
- Tuberculo-opsonic in Man and in Cattle, 363
- Indian-ink, Burri's Method of Demonstrating Spirochaetes, 394
- Method, Appearance found in certain Bacteria when Examined by, 635
- — Burri's, 118
- — in Parasitology, 785
- — of Demonstrating *Spirocheta pallida*, 386
- Indices of Refraction, Absolute. Measurements in Strained Glass, 766
- Refractive. Additional, of Quartz, Vitreous Silica, Calcite and Fluorite, 766
- Indol in Microbic Cultures, Testing for, 373
- Infusorian, Ciliated, Symbiosis, 41
- Infusorians, Adaptation and Immunity to Ethyl-alcohol, 588
- Marine. Parasitic and Commensal, 325
- Ingham, W., Yorkshire Mosses, 736
- Ingots, Steel, Closing of Blowholes, 263
- Tests, 263
- Inheritance of Quantity and Quality in Cows' Milk, 704
- Injecting Objects. *See* CONTENTS
- Injection Methods applied to certain Mollusca, 257
- — Further Note, 382
- Innervation of Tympanum, 154
- Inoceramus Limestone in the Queensland Cretaceous Rocks, Microscopical Structure, 1
- Inouye, K., Metastability of Metals, 389
- Zinc Amalgams, 676
- Insect, New Primitive, 32
- Insecta. *See* CONTENTS
- Insectivore, New, 157
- Insects, Collecting and Preserving, 112
- Injurious, 167, 717
- Regeneration, 305
- Thorax, and Articulation of Wings, 572
- Instruments, Accessories, etc. *See* CONTENTS
- Insulators, High-tension, Use of Polariscopes in Testing, 98
- Integument of *Voeltzkovia mira*, 297
- Interferometer, with Inverse Superposed Luminous Rays, giving in White Polarised Light a Narrow Central Fringe of Sensible Tint and Narrow Coloured Fringes at White Intervals, 654
- Interferometry, Use of Grating, 764
- Intestinal Secretion in Dellephila, 30
- Intastine, Small, Musculature in Villi, 153
- Invertebrata. *See* CONTENTS
- Invertebrates, Marine, Digestion, 561
- Iridescence, Autumnal of Lakes, 314
- Iris-diaphragm for High-power Objectives, 395
- Iron, Action of Hydrogen and Nitrogen on Temper-carbon, 789
- Alloys, 120, 262
- — Magnetic Properties, 391
- and Alloys, Magnetic Properties, 526
- and Steel, Heat-treatment, 262
- — — Transformations, 123
- Cast, Decarburisation by Gaseous Oxidising Agents, 527
- — Structure, 263
- Crystalline Structure at High Temperatures, 389
- Electrolytic, Effect of Temperature upon the Magnetic Properties, 680
- Industry, Importance of Metallography, 392
- Influence of Arsenic and Tin upon, 262
- Metallography, 122
- Phosphides, 262, 526
- Iron-bacteria, New, Further Study, 365
- Iron-carbon Alloys, 390
- — Effect of Low Temperature, 791
- Diagram, 121
- System, Influence of Antimony and Tin, 679
- Iron-copper Alloys, 120
- Iron-copper-nickel, Ternary System, 677
- Iron-manganese Alloys, 120
- Irons, Cast, and Carbon Steels, Constitution, 790
- —, Growth of after Repeated Heatings, 390
- Irritability of Seed Plants. *See* CONTENTS
- Isopods, Antarctic, 457
- Studies, 314
- Ixodes, Filariæ in, 317
- *relivius*, Structure, 312
- *ricinus*, Structure and Habits, 168
- J
- Jaap, O., Myxomycetes of Brandenburg, 496
- Jacobsen, H. C., Volvocæ, 346

- Jacobson, E., Mosquito Fed by Ant, 570
 Jacobson, Organ of, in Ant Bear, 158
 Jacqué, L., *Streptobacterium fetidum*, 758
 Jaczewski, A. v., and others, Uredineæ, 747
 Jameson, H. L., Struggle for Existence among South African Rats, 23
 Jammes, —, Significance of Chitin in Nematode Development, 722
 Jammes, L., Adaptation of Nematodes to Temperature of their Hosts, 458
 Janda, V., Regeneration in Insects, 305
 Janeck, R., Development of Lung-books and Tracheæ in Spiders, 312
 Janet, C., Sensory Structures on Worker Bee's Mandible, 714
 Janicki, C., Study of Lophomonas, 589
 Janse, J. M., *Caulerpa prolifera*, 617
 Janssens, F. A., Spermatogenesis in *Alytes obstetricans*, 152
 Janzen, P., Hepatics of Eisenach, 57
 — Life-history of *Funaria hygrometrica*, 55
 Jatta, A., Italian Lichens, 218
 Jaw, Human Lower, Ossification, 443
 Jeannel, R., Cave Beetles, 452
 Jensen, C., Sphagnaceæ of Siberia, 195
 Jerboa-flca, Cysticeroid, 581
 Johannsen, A., Simple Improvements for a Petrographical Microscope, 643
 Johnson, C. W., New Tipulidæ, 452
 Johnson, M. E., Development of Salpa Chain, 564
 Johnson, T., Bacterial Rot in Turnips, 499
 Johnston, J. R., Ferns of Venezuela, 603
 Johnston, T. H., Entozoa of Monotremes and Marsupials, 319
 — Hæmogregarines in Australian Reptiles, 327
 — Hæmoprotozoa in Birds of New South Wales, 40
 — Notes on Parasitic Protozoa, 327
 Johnstone, J., Parasites from Fishes from Irish Sea, 581
 Joleand, A., Alleged Mimicry in Acorn-shells, 720
 Jolibois, P., Phosphides of Nickel, 388
 — — of Tin, 388
 Jolly, J., Development of Lymphatic Ganglia in Mammals, 150
 — — — of Duck, 294
 — Life of Isolated Cells, 708
 Jones, R. F., Dark-ground Illumination with High Powers, 764
 Jonescu, C. N., Brain of Hive-bee, 164
 Jonson, A., Degeneration and Regeneration of Thymus in Modified Nutritive Conditions, 447
 Jordan, H., External Digestion in *Carabus auratus*, 307
 Jörgensen, P., Argentine Galls, 714
 Joubin, L., Antarctic Nemertean, 460
 — Young Spirula, 451
 Juel, O., Species of Taphrina on Betula, 75
 Jullien, J., Practical Photomicrography, 656
 Jumelle, H., Fungi of Termites Nests, 354
 Juniper, Morphology, 467
 Juniperus, Gametophytes and Fertilisation, 45
- K
- Kaiser, P. E., *Vaucheria synandra*, 348
Kalpidorhyncus arenicolæ, Reproduction, 465
 Katsurada, F., Life-history of *Schistosomum japonicum*, 459
 Kaulfussia and Angiopteris, Development, 594
 Kautzsch, G., Development of *Agelena labyrinthica*, 168
 Kazzauder, J., Hairs on Mole's Hands and Feet, 710
 Keilhaack, L., Generation-cycles in Cladocera, 34
 Keller, C., Zoology of the Minotaur Myth, 563
 Kemp, S., Decapod Natantia of Coasts of Ireland, 576
 — Decapoda from North Side of Bay of Biscay, 456
 Kennel, J., Palæarctic Tortricidæ, 714
 Kent, A. F. S., New Method of Staining spores, 522
 Kern, F. D., Peridial Cells in the Roestelia, 626
 Kerr, J. G., Development of Alimentary Canal in Lepidosiren and Protopterus, 295
 Kershaw, J. C. W., Structure, Habits and Life-history of Candle Fly, 453
 Kesteven, H. L., Australian Tunicates, 25
 Kidney of Teleostean Fish, Injecting, 378
 — — Teleosteans, 449
 Kidneys of Fishes, 564
 Kidston, R., Fossil Osmundaceæ, 595
 — *Zygopteris grayi*, 471
 Kieffer, J. J., Argentine Galls, 714
 Kilduffe, —, Stable Solution of Gentian-violet, 787
 Kindberg, N. C., Canadian Mosses, 612
 Kindle, E. M., Diatomaceous Dust on the Behring Sea Ice-floes, 67
 Kinel, J., Regeneration of Bone in Birds, 557
 King, J. J. F. X., Irish Neuroptera, 166
 Kinoshita, K., New Japanese Muriceids, 727
 — *Telesto rosea*, 585
 Kirchoff, O., Eyes of Pentamerous Beetles, 307
 Kirkman, T., Fresh-water Pleurosigma with Oblique Striæ, 799
 Kirkpatrick, R., Affinities of *Astrosclera willeyana*, 324

- Kirkpatrick, R., Hexactine Spicules, 178
 — Hexactinellid Sponge Spicules and their Names, 324
 — *Merlia normani*, 324
 — Phylogeny of Amphidiscophora, 39
 Kishinouye, K., Japanese Medusæ, 727
 Kittsteiner, C., Methylated Spirits for Histological Purposes, 250
 Kleeberger, F. L., Californian Species of *Cerianthus*, 463
 — New Species of *Cerianthus*, 322
 Klein, E. J., Oak Mildew, 624
 Kleinert, M., Spermatogenesis in *Helix*, 303
 Knebel, W. v., Jurassic and Modern Eryonidae, 313
 "Knee-joint" of *Mougeotia*, 203
 Knight, S. S., Apparatus for Metallographic Work, 792
 Knoll, —, Acid-fast and Granular Types of Tubercle Bacilli, 500
 Knoll, F., Geotropism and Growth in Length of *Coprinus stiriacus*, 485
 Knoll, W., Relations of Nucleus and Cytoplasm, 444
 Knollmann, M., Albuminoid Reserves in Annelids, 169
 Koehler, R., Indian Ocean Shallow-water Asteroids, 584
 Kofoid, C. A., Revision of Genus *Ceratomyxys*, 729
 — Skeleton of Peridinids, 180
 Kohlbrugge, J. H. F., Spermatozoa Entering a Blastula, 442
 Koizumi, M., New Parasitic Amœba in Man, 40
 Kolkwitz, R., Fresh-water Plankton, 65
 — and another, Fresh-water of Brandenburg, 209
 Kollman, M., Functions of Lymphatic Gland of Scorpion, 454
 — *Lernæodiscus*, 576
 — Notes on *Rhizocephala*, 34
 — Twin *Sacculina*, 457
 Kolmer, W., Studying the Labyrinth, 113
 Kominami, K., Biological Experiments with Fungi, 212
 Konstantinow, N., Phosphides of Iron, 526
 Korff, —, *Urophlyctis alfalfæ*, 350
 Korpatschewska, I., Study of Heterothallic Mucorini, 744
 Kossogonoff, J. J., Ultramicroscopic Examination of Liquids during Electrolysis, 658
 Kostanecki, K., Artificial Parthenogenesis in *Aricia*, 35
 Kowalski, J., Studying the Neurofibrils in *Lumbricus*, 376
 Kowler, R., Washing Apparatus for Fixed Material, 250
 Krasser, F., Fossil Marattiaceæ, 595
 Krecker, F. H., Eyes of *Dactylopius*, 29
 — Regeneration in Oligochaets, 577
 Krieg, W., and others, Uredineæ, 208
 Krönig, G., Morphological Demonstration of Methæmoglobin in Blood, 788
 Krüger, E., Structure and Habits of *Claviger testaceus*, 571
 Kruger, F., Cytology of *Albugo candida* and *Peronospora Ficiariæ*, 622
 Krumbhaar, W., Solubility of Gases in Metals and Alloys, 530
 Krüss Epidiascope, 229
 Köhl, H., Cultivation of Mould from Rancid Butter, 499
 Kuhn, A., Budding and Shoot-formation of Hydroids, 175
 — Ontogeny and Phylogeny of Hydroids, 585
 Kühnemann, —, Morphological Differentiation of *Bacillus paratyphosus* and *Bacillus typhosus*, 363
 Kükenthal, W., Observations on Living Alcyonarians, 177
 Kuleznski, V., Fragmenta Arachnologica, 310
 Kümmerle, J. B., New Species of Ceterach, 339
 Kunstler, J., Cytoplasmic Fibrillation of *Chilomonas*, 729
 Kuntz, A., Role of Vagi in Development of Sympathetic Nervous System, 295
 Kurnakow, N. S., Alloys of Lead with Indium and Thallium, 261
 Kurssanov, L., Phylogeny of the Archegonium, 735
 — Sexuality of Rust Fungi, 484
 Kusano, S., Studies in *Æginetia*, 45
 Kwietniewski, C., Development of Wolfian and Müllerian Ducts in Rodents, 150
 Kylin, H., New Batrachospermum, 743

L

- Labelling Microscope Slides, 267
 Laboratory, National Physical, 794
 — Roscoff, 477
 Labridæ, Parasites, 728
 Labyrinth of Vertebrata, Studying the Finer Structure, 113
 — Studying, 113
 Lacouture, Abbé Charles, 195
 Lactic Acid Bacteria of the so-called Bulgarian type, Observations, 89
 Laing, R. M., Algæ of Auckland and Chatham Islands, 744
 Lambert, F. D., Characium, 616
 — Coleochaete, 616
 Lamellibranchiata. See CONTENTS
 Lamellibranchs, Byssus-apparatus, 304
 — Commensal, 303
 — Marine, of Siam, 566
Laminaria digitata and *L. saccharina*, 196
 — Epiphytes, 196
 — *saccharina* and *L. digitata*, 196

- Lammermayr, L., Orientation of *Botrychium Lunaria*, 471
- Lamp, Beck-Gordon Speculum, 92
- Mercury Vapour. Note on the Use in Observing the Rings and Brushes in Crystals, 440
- Lampa, E., Relationship of Liverworts to Ferns, 53
- Lamprey, Segmentation and Gastrulation, 443
- Venous System, 564
- Lams, H., Polar Bodies in *Arion empiricorum*, 26
- Land Bridge, Former, between Northern Europe and North America, 302
- Lane, H. H., Classification of Edentates, 158
- Placentation in Tatn, 153
- Lang, W. D., Growth-stages in *Parasmilia*, 177
- Lang, W. H., Suspensor in Helminthostachys, 596
- Lange, F., Classification of the Aloes by Leaf-structure, 331
- Langhans, V. H., Rudimentary Antennary Gland in Cladocera, 34
- Lankester, Sir E. Ray, The President's Address, 137
- Lannelongue, —, Supplementary Function of Foot in Yellow Races, 298
- Lantsberry, A. H., Copper-aluminium-manganese Alloys, 789
- Lapicque, L., Newt without Lungs, 711
- Larne, G. R., New Species of *Proteocephalus*, 582
- Larvæ and Pupæ of West African Culicidæ, 716
- Lepidopterous, Horn-feeding, 714
- Marine, Rearing, 563
- of *Cnethocampa pinivora*, Procession and Pupation, 715
- of *Megatoma undata*, 452
- of *Tetrarhynus unionifactor*, Endogenous Multiplication, 723
- Larval Spinoid, Precocious Maturity, 721
- Lasiodiplodia Fiorii*, Development, 351
- Lastrea remota*, 734
- Latham, V. A., Slides mounted by B. F. Quimby, 400
- Launoy, L., Cell Inclusions in Rabbit's Liver, 383
- Lauterborn, R., Vegetation of the Upper Rhine, 741
- Laven, L., New Pathogenic Coccobacillus, 363
- Laveran, A., Coccidian in Bile-ducts of Agama, 328
- Cultivation of *Leishmania Donovanii* in Fluid Media, 245
- Endogenous Multiplication of *Hæmogregarina sebai*, 730
- New Trypanosome in a Vole, 326
- Studies on Trypanosomes, 326, 465
- Laveran, A., Trypanosome of Lerot, 729
- Lavison, J. de R., Function of the Endodermis and Selective Absorption by Protoplasm, 591
- Law, E. F., Phosphor-bronze, 676
- Lead, Alloys with Indium and Thallium, 261
- and Tin Alloys, 119, 260
- Bronzes, 526
- Lead-tin Alloys, 525
- Leaf-movements in Polytrichaceæ, Mechanism, 735
- Leaves, Accessory, in Mnium and Orthomnion, 55
- Green, Blackening, 335
- Youth-form, and its Significance, 592
- Lebrun, H., Rotatory Method in Microscopy, 255
- Lécaillon, A., Segmentation of Unfertilised Egg of Fowl, 442
- Vitelline Membrane in Egg of Birds, 293
- Leche, W., Significance of Milk Dentition, 299
- Lecidea mougeotioides* in Britain, 495
- Leeches, Body-wall, 579
- Japanese, 458
- New, from Ceylon, 170
- Legendre, R., Golgi's Method for Examining the Internal Network of Spinal Marrow Cells, 384
- Internal Reticulum in Ganglion-cells, 446
- Léger, L., Chytridiopsis, 42
- Cnidosporida in Mayfly Larvæ, 465
- Léger, M., Leucocytozoon from Chinese Partridge, 40
- — of the Fowl, 327
- Microfilariae of Fowl, 36
- New Parasites in Bulbul's Blood, 729
- Legros, R., Development of Nephridium in Amphioxus, 443
- Leiper, R. T., New Nematode from Trinidad, 583
- Leishmania Donovanii*, Cultivation in Fluid Media, 245
- Leitz Mirror Condenser, Improvements, 761
- Lelièvre, —, Nature of the Bursa Fabricii, 709
- Peyer's Patches in Birds, 709
- Lelièvre, A., Mammalian Red Blood Corpuscles, 297
- Mucous Epithelium, 445
- Red Blood Corpuscles of Mammals, 708
- Lehmann, E., Algæ of Brandenburg, 620
- Lemoine, P., *Lithothamnium calcareum*, 619
- Lendvai, J., Apparatus for Whetting a Microtome Knife, 253
- Lentz, O., New Anaerobic Apparatus, 520
- Leon, N., Abnormalities in Bothriocephalus, 172

- Leon, N., *Diplogonoporus brauni*, 582
 — Roumanian Blood-sucking Diptera, 571
 Leperditia, New Species, 34
 Lepidoptera, Female, Odoriferous Organs, 165
 — Larval, Malpighian Tubes, 306
 Lepidopterous Larvæ, Horn-feeding, 714
 Lepidosiren and Protopterus, Development of Alimentary Canal, 295
 Leprosy Bacillus, Cultivation, 521
 Leptolegnia from North Carolina, 73
 Lernaëdiscus, 576
 Lernaëpodidæ, Fresh-water, 314
 — Protandrous Hermaphroditism, 720
 Lerot, Immunity to Viper's Poison, 22, 710
 — Trypanosome, 729
 Leroux, A., Nickel-carbon Alloys, 525
 Lesdain, B. de, Bryophytes of Dunkerque, 737
 — Lichens from Greece, 84
 — Study of the Lichens of Dunkerque, 755
 Lesquereux, Leo, 61
 Lett, H. W., Bryophytes of Co. Donegal, 737
 — John Henry Davies (1838-1909), 61
 Leucernarids, Development, 38
 Leuco-reaction in Pregnancy, 296
 Leucocytes, Simple Method of Counting, 259
 Leucocytozoon from Chinese Partridge, 40
 — of Fowl, 327
 Leuvenia, a New Genus of Flagellates, 614
 Levaditi, C., Cultivation of *Spirochæta gracilis* and *S. balanitidis*, 110
 — and another, Examination of the Blood for Trypanosomes, etc., 247
 Léveillé, H., New French Ferns, 190
 Levi, E., Bacterial Flora in the Ice of Monte Rosa, 361
 Levy, —, Diagnostic Value of the Staining Method of Gasis, 671
 Levy, D. M., Constitution of Cast Irons and Carbon Steels, 790
 Levy, O., Experimental Study of Development during the past decade, 258
 Lewis, C. E., Endomyces on Apples, 745
 Lewis, I. F., *Griffithsia Bornetiana*, 70
 — Periodicity in Dictyota at Naples, 618
 Lichen, Primitive, 219
 Lichen-flora of Bohemia and Moravia, 633
 — of the Saal Valley, 218
 Lichens, Absorption of Water, 219
 — Arctic, 84
 — Chemistry, 85
 — Epiphytic, 755
 — from Brazil, 218
 — from Greece, 84
 — Italian, 218
 — New, 84
 — of Aragon, 495
 — of Dunkerque, Study, 755
 — of Minnesota, 756
 Lichens of the Azores, 359
 — Relation between Gonidia and Hyphæ, 494
 — Russian, 218
 — Siberian, 85
 — Useful Plants among, 219
 — See CONTENTS
 Lichtenecker, K., Resistance of Alloys free from Solid Solutions, 793
 Lidforss, B., Connecting Threads between Nucleus and Chromatophores, 329
 Light, Abyssal, Theory, 562
 — and Phosphorescence, Reaction of Marine Organisms, 155
 — and Pigment-formation in *Crenilabrus* and *Hippolyte*, 719, 773
 — Influence upon Fruit- and Seed-development, 593
 — Reactions of Amphibians to, 559
 — — on *Gonionemus*, 727
 — Scattered from Rough Surfaces, Methods of Determining the Amount, 101
 — Standard Measurement in Wave-lengths, 235
 Light-polarisation Phenomena in Solid and Pseudo-liquid Organised Matter, 518
 Ligia, Colour Change, 719
 Lignier, O., and another, Fossil Ferns of France, 596
 Limbs in *Lithobius*, Abnormal Pair, 167
 Limpet and Calyptræa, Topographical Memory, 26
 Limpet's Shell, Growth, 163
 Lindau, G., Hyphomycetes, 75, 352, 483
 Lindaucom, G., Hyphomycetes, 626
 Linden, M. v., Assimilation of Carbon Dioxide by Pupæ, 306
 — Tentacle-like Processes on *Opalina dimidiata*, 41
 Linder, K., Staining Prowazek's Bodies, 787
 Linsbauer, K., Chloroplast-movements, 184
 Linstow O. v., New Nematodes, 36
 — New Species of *Atractis*, 458
 — — — of *Davainea*, 37
 — — — of *Pseudalius*, 722
 — Studies on Nematodes, 36
 Lion, *Ascaris mystax* in, 36
 Lipman, J. G., Quantitative Estimation of Soil Bacteria, 362
 Lipids in Cells, Demonstrating the Presence, 117
 Lippmann, A., Demonstrating Tubercle Bacilli in the Blood, 673
 Liquids, Measurement of Refraction Index by the Microscope, 243
Lithobius, Abnormal Pair of Limbs, 167
 Lithocysts in *Ficus*, 466
Lithothamnium calcareum, 619
 Live-box made by Andrew Pritchard, 269

- Liver, Mammalian, Embryonic, Blood-formation, 18
 — Rabbit's, Cell Inclusions, 383
 Liverwort Types for Elementary Classes, 54
 Liverwort-rhizoids, Physiology, 54
 Liverworts, Primitive Form, 607
 — Relationship to Ferns, 53
 Lizard, Mechanism of Respiration, 158
 Lloyd, C. G., Mycological Notes, 78, 354, 486
 — Synopsis of Phalloids, 78
 Lloyd, R. E., Supposed Evidence of Mutation in *Malthopsis*, 160
 Lo Bianco, S., Period of Sexual Maturity in Marine Animals, 302
 Loebe, R., Improvements in Metallographical Methods, 527
 Loeske, L., Phylogenetic Classification of Mosses, 735
 Löhner, L., Structure of *Polychærus caudatus*, 459
 Leisel, G., Influence of Male Parent in Heredity, 296
 Lojacono-Pojero, M., and another, Italian Ferns, 339
 Loligo, Development of Cœlomic and Vascular System, 161
 Lönnerberg, E., Variation in Skull of Sea-elephants, 710
 Lophomonas, Study, 589
 Lorch, W., Mechanism of Cohesion in Moss-leaves, 193
 — Mechanism of Leaf-movements in Polytrichaceæ, 735
 — Polytrichaceæ, 343
 Loreuz, A., and others, North American Bryophytes, 611
 Lorrain, A., Physiology of Senescence, 447
 Lorsche, L., Moss-flora of Zillertal, 57
 Lotsy, J. P., Primitive Form of the Liverworts, 607
 Loups, Binocular, of Weak and Medium Magnification, 235
 Low, A., Ossification of Human Lower Jaw, 443
 Lowry, T. M., Additional Refractive Indices of Quartz, Vitreous Silica, Calcite, and Fluorite, 766
 Löwy, R., Double Gall-Bladder in Cat, 711
 Lubimenko, M., Influence of Light upon Fruit- and Seed-development, 592
 Lubosch, W., Calcification of Selaclian Cartilage, 446
 Lucernarids, Development, 585
 Ludwig, H., New Order of Asteroids, 726
 Luetzelburg, P. v., Utricularia, 183
 Luisier, A., Moss-flora of Madeira, 58
 — — of Portugal, 58
 — Muscinæ of Madeira, 344
 — What is *Dicranoweisia robusta* Vent? 608
- Lumbricidæ, Regeneration, 315
 Lumbricus, Studying Neurofibrils, 376
 Luminescence in Chironomus, 31
 Luminosity of Glow-worm, 166
 — of Moss Leaves, 606
 — of Ophiuroids, 38
 — of *Phyllirhoe bucephala*, 565
 Lungless Salamandrid, 24
 Lungs, Newt without, 711
 Lutman, B. F., Closterium, 478
 Lychnis, Inheritance of Colour, 337
 — — of Sex, 337
 Lycopodiales, Japanese, 191
Lycopodium annotinum, Stomata, 598
 — *complanatum*, American Forms, 603
 — New Species, 51
 — Prothallial Development, 597
 — *pithyoides*, Sporangium, 734
 — *Selago*, Curious Habitat, 597
 Lygodium and Anemia, Prothallia, 337
 Lymphatic Ganglia in Duck, Development, 294
 — — in Mammals, Development, 150
 — Gland of Scorpion, Functions, 454
 Lynceus, Alimentary Tract, 456
Lynchia maura, New Host, 570
 Lyuge, H., Marine Lamellibranchs of Siam, 566

M

- McAllister, F., Embryo-sac of *Smilacina stellata*, 46
 McAlpine, D., *Phytophthora infestans*, 481
 McAndrew, J., *Pallavicinia flotowiana* in Scotland, 736
 MacBride, E. W., Studying the Development of Amphioxus, 115
 McClendon, J. F., Ophiurans of San Diego, 174
 McCubbin, W. A., Development of *Helvella elastica*, 350
 MacCurdy, H. M., Double Snail, 713
 Macdonald, J. J., Scotch Ferns, 734
 McDunnough, J., Minute Structure of Gut in *Chrysopa perla*, 309
 McIntosh, J., *Spirochaeta pallida* in Ova of Congenitally Syphilitic Child, 181
 McJunkin, F. A., Staining Sections by the Romanovsky Method, 384
 Mackie, F. P., Amakebe and East Coast Fever, 326
 Mackinnon, D. L., Indian Ocean Aleyonaria, 584
 Macroscelidæ, 299
 Macroscopy and Microscopy in Workshop Practice, 528
 Macrurid, Antarctic, 159
 Macvicar, S. M., Distribution of Hepaticæ in Scotland, 736
 — Scottish Hepaticæ, 609
 McWilliam, A., Chromium Steel, 790
 Madreporaria from Mergui, 463

- Madreporaria of the Gulf of Guinea, 726
 Magnesium Aurides, 261
 — Use in Stupefying Marine Animals, 246
 Magnetic Character of Compounds of
 Non-magnetic Elements, 264
 — Properties of Alloys of Ferro-magnetic
 Metals, 264
 — — of Electrolytic Iron, Effect of Tem-
 perature upon, 680
 Maige, A., Chromosomes of *Asphodelus*
microcarpus, 182
 Maire, R., Classification of Russulæ, 485
 — Plasmodiophoracea, 634
 — *Podosecypha nudulata*, 77
 Makino, T., Japanese Ferns, 192
 Makrinoff, S., *Bacillus bulgaricus* vel *B.*
lactis acidi, 361
 Malacology of Equatorial Africa, 26
 Malaria in Birds of Greece, 40
 Male Parent, Influence in Heredity, 296
 Malloch, J. R., Subdivisions of Genus
 Phora, 716
 Malpighian Tubes in Larval Lepidoptera,
 306
 — — in Muscids, Metamorphosis, 306
 Malthopsis, Supposed Evidence of Muta-
 tion, 160
 Mammalia, Studying the Development of
 Dentine, 258
 Mammals, Development of Dentine, 557
 — — of Lymphatic Ganglia, 150
 — Hyaline Cartilage, 446
 — Red Blood Corpuscles, 708
 Mammary Glands, Affinities, 709
 Man, J. G. De, New Alpheidæ, 718
 Mandible, Worker Bee's, Sensory Struc-
 tures on, 714
 Mangan, J., Entry of Zooxanthellæ into
 Oyum of Millepora, 463
 Manganese, Vanadium, and Chromium,
 Magnetic Properties, 526
 Mangifera, Anatomical Study, 590
 Mangin, L., *Aspergillus glaucus*, 206
 Mangold, E., Reactions of Echinoderms,
 321
 Manipulation, Microscopical. *See* CON-
 TENTS
 Maquenne, L., Blackening of Green
 Leaves, 335
 Marantonio, M., Lead Bronzes, 526
 Marattiaceæ, Fossil, 595
 Marceau, F., Adductor Muscles, 26
 Marchal, E. and E., Apospory and Sexuality
 in the Mosses, 340
 Marchand, E. F. L., *Plasmodiophora*
Brassicæ, 496
 Marchantia, Androgynous Receptacles,
 472
 — Chemotaxis of Spermatozooids, 193
 Marchantiales, Rhizoids, 605
 Marcus, H., Development of Head of
 Gymnophiona, 19
 Maréchal, J., Oogenesis in Raiadæ, 443
 Marino, F., Aerobic Cultures of "Anaero-
 bic" Organisms, 111
 Marryat, D. C. E., Hybridisation in Mira-
 bilis, 336
 Marsilia, Origin of Heterospory, 188
 Marsupella and Acolea, 607
 Marsupial Skull, Development, 18
 Marsupials and Monotremes, Entozoa, 319
 Martelli, G., Study of Puss Moth, 30
 Marten, J., Indian Ferns, 735
 Martens, A., Change of State in Metals
 under Mechanical Strain, 529
 Martiis, L. de, Earthworms of Ruwenzori,
 315
 Martin, —, Significance of Chitin in
 Nematode Development, 722
 Martin, A., Adaptation of Nematodes to
 Temperature of their Hosts, 458
 Martin, C. H., Division of *Trypanoplasma*
congeri, 729
 Martin, P., Application of Edinger's Draw-
 ing and Projection Apparatus to
 Macroscopic Photography, 230
 Martini, E., Subcuticula and Lateral
 Areas of Nematodes, 170
 Martinotti, L., Hæmatin Stains, 786
 — Staining Eosinophilous Cells, 118
 — Toluidin-blue, 786
 Maruyama, T., Method of Staining Peri-
 pheral Nerves, 256
 Masay, F., *Streptobacterium fetidum*, 758
 Massalongo, C., Acolea and Marsupella,
 607
 Massart, J., Fairy Rings, 749
 Masee, G., Notes on the Larger Fungi,
 486
 — Text-book of Plant Diseases, 487
Massilia secans, A Contribution towards
 the Ætiology, 693, 796
 Massonnat, E., New Host of *Lynchia*
maura, 570
 Massy, A. L., Dibranchiate Cephalopods
 of Coasts of Ireland, 451
 Mast-cells and Plasma-cells, 155
 Mastigamæbæ, 327
 Mataré, F., New Tetracotyle from Brain
 of Minnow, 459
 Mathis, C., Leucoctozoon from Chinese
 Partridge, 40
 — — of the Fowl, 327
 — Microfilaria of Fowl, 36
 — New Parasites in Bulbul's Blood, 729
Matonia sarmentosa, Anatomy, 49
 Matruchet, L., Pathogenic Fungi, 356
 Maturity, Sexual, Period of in Marine
 Animals, 302
 Matweiff, —, Metallographical Study of
 Slags, 794
 Maublanc, —, Oak Mildew, 482
 — and others, Plant Diseases, 356
 Maximenko, M. S., Alloys of Silver with
 Zinc, 260
 Maximow, A., Development of Blood, 442

- Maximow, A., Preparing Delicate Embryonic Tissues for Histological Examination, 251
 — Researches on Blood and Connective-tissue, 114
 Maxon, W. R., Studies of Tropical American Ferns, 190
 Mayer, A., Chemical Basis of Gram's Method of Staining, 381
 Mayer, A., Mitochondria of Hepatic Cells, 558
 Mayer, A. G., Relation between Ciliary and Muscular Movements, 298
 — Use of Magnesium in Stupefying Marine Animals, 246
 Mayer, P., Methods of Staining Glycogen, 381
 — Terpineol for Microscopic Purposes, 523
 Mayerhofer, F., Ribs of Urodela, 159
 Mayfly Larvæ, Cnidosporidia, 465
 Mazé, P., Scientific Cheesemaking, 498, 638, 757
 Mazzotto, D., Composition of Mixed Crystals in Alloys, 392
 Mealworms, Reactions, 307
 Measurement of the Diameter of the Flagella of the Cholera Bacillus prepared by Löffler's Method, 290
 — of the Flagellum of the Cholera Bacillus, 270
 — of the Refraction Index of Liquids by the Microscope, 243
 — of the Refractive Index of Opaque Bodies, New Form of Polarimeter, 93
 Measurements, Micrometric, by a Projected Scale, 368
 Mecklenburg, W., Systems: Tin-sulphur, Tin-selenium, Tin-tellurium, 261
 Media, Culture, New Method of Preparing, 663
 Medusæ, Antarctic, 462
 — Fresh-water, 268
 — Japanese, 727
 — Medusoids, and Ctenophores of Firth of Forth, 176
 — of the Gulf of Trieste, 323
 — of Western Atlantic, Notes, 463
 Medusoids, Medusæ, and Ctenophores of Firth of Forth, 176
 Mees, C. E. K., Resolving Power of Photographic Plates, 99
Megaloma undata, Larvæ, 452
 Mehlhose, R., Presence of Bacteria in Echinococci and Cysticerci, 88
 Meissner, H., Effects Produced by Rolling, 792
 Melikov, B. L., Spores of *Bacillus perfringens*, 223
 Melting-points, Determination, 264
 Meningococci, Cultivation, 774
 Meningococcus, Cultivating, 110
 Mennell, F. P., Pleochroic Halos, 243
 Menz, J., Secondary Attachment in Florideæ, 480
 Mercier, L., Heredity in Connexion with Cancer, 705
 Mercury Vapour Lamp, Note on the Use in observing the Rings and Brushes in Crystals, 440, 535
Merlia normani, 324
 Merlin, A. A. C. E., On the Measurement of Grayson's Ten-Band Plate, 5, 126
 — — — — of the Diameter of the Flagella of the Cholera Bacillus prepared by Löffler's Method, 270, 290
 — — — — of the First Nine Groups of Grayson's Finest Twelve-band Plate, 144, 267
 — Photographs of Grayson's Rulings, 801
Merulius lacrymans, 353
 Mesnil, F., Trypanosome in an Edentate, 729
 Mesonacidae, Olenellus and other, 718
 Metachromatic Granules in Acid-fast Bacilli, 497
 Metal Sections, Mounting, 528
 Metallic Alloys, Thermo-electric Properties, 529
 — Deposits, Use of, in Metallography, 123
 Metallographic Observations at High Temperatures, 264
 — Work, Apparatus, 792
 Metallographical Methods, Improvements, 527
 — Study of Slags, 794
 Metallography, Importance in the Iron Industry, 392
 — in German and Belgian Laboratories, 792
 — of Iron, 122
 — of Zinc, 788
 — Use of Metallic Deposits in, 123
 — See CONTENTS
 Metals and Alloys, Shrinkage, 388
 — — — Solubility of Gases, 530
 — and Compounds, Heat-capacity, 793
 — and Nitrogen at High Temperatures, 678
 — "Damping" Test, 529
 — Electron Theory and Solid Solutions, 529
 — Galvanised, Testing, 124
 — Homogeneity, 529
 — Influence of Pressure on the Boiling-points, 531
 — Metastability, 389
 — Mixtures of, Effect of Compressing, 388
 — New Method of Coating with, 531
 — Non-ferrous, Properties, 794
 — Spark Spectra, 793
 — under Mechanical Strain, Change of State, 529
Metamera schubergi, g. et. sp. n., A New Gregarine, Observations, 659

- Metameres of Petromyzon, 152
 Metamorphosis, Histology, 306
 — of Malpighian Tubes in Muscids, 306
 — of Muscids, Studying, 376
 Metastability of Metals, 389
 Methæmoglobin in Blood, Morphological Demonstration, 788
 Methylated Spirits for Histological Purposes, 250
 Metzgeria, Vegetative Reproduction, 472
 Meunier, L., New Method of Fixing Plankton, 375
 Meves, F., Identity of Flemming's and Altman's Granules, 671
 — Male Mitochondria in Fertilized Ovum, 557
 — Structure of Embryonic Supporting Tissue and Origin of Connective-tissue Fibrils, 298
 Meyer, A., Ancestry of Plants, 733
 Meyer, E., Development of Blindworm, 443
 Meylan, C., Moss-flora of the Jura, 610
 — and others, French Mosses, 344
 Mice, White, Somatic Modifications, and their Reappearance in the Offspring, 706
 Michael, A. D., 134, 267
 "Michael Sars' North Atlantic Deep-sea Expedition, 1910, 772
 Michailow, S., Staining Nervous Tissues with Methylene-blue, 785
 Micheletti, L., Bryophyta of Sicily, 194
 — Mosses of Italian East Africa, 58
 Micoletzky, H., Turbellarians of the Gulf of Trieste, 318
 Micro-chemical Tests for Identification of Varieties of Glass, 768
 Micro-colorimeter, Convenient Form of Stand for use as, and with Micro-spectroscope, 14, 127
 Micro-fungi, Notes, 750
 Micro-fungus Flora of Central Russia, Contribution, 355
 Micro-organisms and Electricity, 496
 Microbe of Peripneumonia of Cattle, Morphology, 361
 Microbes on Fruit, 86
Micrococcus melitensis and Malta Fever, 361
 — — Endotoxin, 635
 Microfauna, Fresh-water, of German East Africa, 450
 Microfilaria of Fowl, 36
 Microfungi in Cheese Curds, 212
 Micrometer, Ocular, with Interior Vernier, 230
 Micrometric and Diffraction Rulings, On the Production, 239
 — Difficulty, 696, 797
 — Measurements by a Projected Scale, 368
 — — Comparative, 399, 537
 Microphotography, Cheap Non-vibrating Suspension, 99
 Microscope Device, Useful, 760
 — for Investigating Ultra-microscopical Particles, Zeiss', 91
 — Heat, New, 366
 — Nature through, Spiers', 244
 — Old Achromatic, by Trécourt and Georges Oberhauser, 640
 — Old, made at Nürnberg, 400
 — Old, presented by Mr. A. Ashe, 642
 — Old, presented by Mr. C. F. Rousselet, 642
 — Petrographic, F. E. Wright's New, 502
 — Petrographical, Simple Improvements, 643
 — Petrological, Watson and Sons "Advanced," 506
 — Quidor-Nachet, 649
 — Slide Cabinets, 524
 — Watson and Sons "Royal," 646
 — Watson's Naturalist's, 224
 — What did our Forefathers see in, 427
 Microscopes by R. Winkel, 804
 Microscopical Manipulation. *See* CONTENTS
 — Optics. *See* CONTENTS
 — Structure of an *Isoceras* Limestone in the Queensland Cretaceous Rocks, 1
 — Technique. *See* CONTENTS
 Microscopy and Macroscopy in Workshop Practice, 528
 — Critical, 282
 — Examination in, 771
 — Rotatory Method, 255
 — *See* CONTENTS
 Micro-Spectroscope, Convenient Form of Stand for use with, and as Micro-colorimeter, 14
 Microspore-formation in *Chaetoceras Lorenzianum*, 64
 Microsporidia, Nuclear Hypertrophy induced by, 328
 Microstructure of Copper, 260, 387
 Microtome, Brain, Improved, 377
 — Eighteenth Century, 779
 — Flatters and Garnett's "Firmax," 665
 — Knife, Apparatus for Whetting, 253
 — Large Sliding, 778
 Microtomes. *See* CONTENTS
 Microzoa in Shales from New South Wales, 39
 Mid-gut, Development, in a Beetle, 30
 Miescher's Bodies, 730
 Miessner, —, Fixation of the Complement in Glanders, 87
 Mietens, H., Origin of Blood in Toad, 556
 Migula, W., German Fungus-flora, 211, 749
 Mildew, American Gooseberry, 746
 — Diseases, Two Epidemic, 482
 — Oak, 482, 747
 — of Apples, 746

- Milk, Colostral, Apparent Bactericidal Influence, 710
 — Cows', Inheritance of Quantity and Quality, 704
 — Dentition, Significance, 299
 Millar-Williams, E. B., "On a New Fine-adjustment for Body and Substage of Microscopes," 535
 Millepora, Entry of Zooxanthellæ into Ovum, 463
 Miller, N., Habits of American Toads, 300
 Millipedes, British, 717
 — New, 310
 Mimicry, 558
 — Alleged, in Acorn-shells, 720
 — Defensive, Case of, 27
 Minchin, E. A., Transmission of *Trypanosoma lewisi* by Rat-flea, 326
 Minerals, Method of Estimating the Hardness, 259
 Minonescu, T., New Variety of Mycosis occurring in Man, 637
 Minotaur, Myth, Zoology of, 563
 Mirabilis, Hybridisation, 336
 Mislawsky, A. N., Vesicular Secretion, 155
 Mitchell, G., Strobilus of Selaginella, 187
 Mites in Man, 455
 — in Tumours, 455
 — Structure and Development, 33
 Mitochondria, Male, in Fertilized Ovum, 557
 — of Hepatic Cells, 558
 Mitochondrial Elements of Germ-cells and Chondriosomes of Embryonic Cells, 294
 Mitosis in Synchytrium, 43
 Mnium and Orthomnium, Accessory Leaves, 55
 — Spermatogenesis, 192
 Mole, Peculiar Trematode, 318
 Mole-ericket, Development of Endoderm, 165
 Mole's Hands and Feet, Hairs, 710
 Mollier, S., Blood-formation in Embryonic Mammalian Liver, 18
 Mollusca, Injection Methods applied to, 257
 — Ecological, Study, 451
 — See CONTENTS
 Monascus, 624
 — Development, 74
 — New Species, 745
 Monaxonids, New, 324
 Mönkemeyer, W., Abnormal Capsules in *Bryum argenteum*, 735
 Monochromatic Illumination, 514
 Monolistrini, Revision, 456
Monoselenium tenerum, 474
 Monotremes and Marsupials, Entozoa, 319
 Monstrosity, What is a, 712
 Montgomery, T. H., Courtship of Spiders, 573
 Montgomery, T. H., jun., Behaviour of Spiders, 454
 — Spinnerets, Cribellum and Respiratory Organs of Spiders, 312
 Moore, B., Reaction of Marine Organisms to Light and Phosphorescence, 155
 Moore, C. I., Myxomycetes of Pictou County, 756
 Moore, H., A₂ Point in Chromium Steel, 790
 Moore, H. K., Varieties of *Polypodium vulgare*, 601
 Moore, J., American Polychætes, 315
 Morgan, W. de, *Upogebia stellata* and *Gebia deltura*, 456
 Morgenthaler, O., Uredinæ, 484
 Morgulis, S., Regeneration in *Ophiocoma pumila*, 174
 Morris, E. R., Structure of *Asymmetron bassanum*, 25
 Morse, E. S., Early Stage of Aemæa, 451
 Morse, M., Nuclear Components in Sex-cells of Four Species of Cockroaches, 31
 — Reactions of Mealworms, 307
 — Shaking Experiments with Protozoa, 325
 Mortensen, T., New Parasitic Alga, 742
 Mosquito Fed by Ant, 570
 Moss and other Objects mounted in Fluid, 800
 — Book, North American, 611
 — Criticisms, 614
 — Exchange Club, British Mosses, 341
 — New Hybrid, in Sussex, 342
 — Remains, "Neolithic," 609
 — Species of *Tylenchus* in, 458
 Moss-flora, Norwegian, 56
 — of Greece, 57
 — of Madeira, 58
 — of Moravia, 57
 — of Portugal, 58
 — of the Haute-Saône, 610, 737
 — of the Isle of Pines, 345
 — of the Jura, 610
 — of Podmorden, 609
 — of Zillerthal, 57
 Moss-leaves, Cohesion-mechanism, 341
 — Luminosity, 606
 — Mechanism of Cohesion, 193
 Mosses, Antarctic, 739
 — Apospory and Sexuality, 340
 — Bolivian, 59, 194
 — British, 341
 — Canadian, 612
 — East African, 476
 — European, New and Rare, 194
 — — Rare, 611
 — found in Conservatories, 342
 — French, 344
 — Geneva, 738
 — German, New, 56
 — Lancashire, 341

- Mosses, Lancashire, New, 609
 — Mexican, 345, 476, 613
 — New Philippine, 59
 — Norwegian, 343
 — of Hamburg, 343
 — of Hungary, 57
 — of Italian East Africa, 58
 — of Japan and Corea, 195
 — of Madagascar, 739
 — of New England, Critical, 611
 — of New Guinea and the Moluccas, 59
 — of Savoy, 194
 — of the Italian Islands, 738
 — of the Pyrenees, 344
 — of the Rhöngebirge, 194
 — of Western India, 738
 — Philippine, 738
 — Phylogenetic Classification, 735
 — Prehistoric from Lincolnshire, 736
 — Prussian, 737
 — Scottish, New, 56
 — Sexuality, 603
 — Swiss, 737
 — Tropical, Types, 606
 — Yorkshire, 342, 736
 Moth, Puss, Study, 30
 Mottier, D. M., Sex of Gametophyte of
 Onoclea, 733
 Mougeotia, "Knee-joint," 203
 Mould from Rancid Butter, Cultivation,
 499
 Moulds, Growths in Oil, 484
 Mounting Frozen Sections, 786
 — Objects. *See* CONTENTS
 — of Metal Sections, 528
 — Serial Celloidin Sections, 787
 — Spider Dissections as Microscopical
 Objects, 385
 Mouth and Pharynx of Hamster, 564
 Mouth-parts of Wasps and other Hymen-
 optera, 164
 Mozejko, B., Formalin for the Preparation
 of Museum Specimens, 523
 — Further Note upon Injection Methods,
 382
 — Injection Methods applied to certain
 Mollusca, 257
 — Preparation of Osteological Specimens,
 523
 — Venous System of the Lamprey, 564
 Mrázek, A., Distomid Cyst in Blood-
 vessels of an Oligochaet, 459
 — Excretory System in Triclad, 37
 Mucilage-glands of Undaria, 68
 Mucorini, Experiments, 349
 — Heterothallic, Study, 744
 Mucus of Amphibians, Toxic Action,
 448
 Mullenix, R. C., Demonstrating Peripheral
 Nerve Terminations, 115
 — Peripheral Terminations of Eighth
 Cranial Nerve, 154
 Müller, K., European Hepatics, 611, 737
 Müller, O., Bacillariaceæ from Nyassa
 Land, 616
 Müllerian and Wolffian Ducts in Rodents,
 Development, 150
 Mullett, Variation, 161
 Murbach, L., Light Reactions of Gonione-
 mus, 727
 Muriceids, Japanese, New, 727
 Murray, H., Compsopogon, 619
 Murray, J., 533, 534
 — Microscopic Fauna at Cape Royds, 450
 Murray, T. M., Copper-zinc Alloys, 675
 Murrill, W. A., Protection of Shade Trees
 against Attacks of Fungi, 354
 — and others, Notes on some Larger
 Fungi, 209
 Muscidæ, Studying Metamorphosis, 376
 Muscids, Metamorphosis of Malpighian
 Tubes, 306
 Muscineæ, Chinese, 345
 — Italian, 344
 — of Madeira, 344
 — of the Julian Alps, 344
 — of Yorkshire, 55
 Muscle, Glycogen, 446
 — Heart, Structure, 297
 — Papillary, and Chordæ Tendineæ,
 Junction, 155
 — Tensor, of Choroid in Teleosteans, 449
 Muscle-cells and Intestinal Cells of As-
 carids, Fibrillar Structures, 170
 Muscle-insertions in Arthropods, 164
 Muscle-spindles, Demonstrating, 664
 Muscles, Adductor, 26
 Muscular and Ciliary Movements, Relation
 between, 298
 Musculature of Hirudinea, 35
 — of Owenia, 169
 Museum Specimens, Formalin for Prepara-
 tion, 523
 Mushrooms, Distribution of Poisons in, 628
 — Edible and Poisonous, Coloured Draw-
 ings, 627
 — — and otherwise, 78
 Mussels Settling in Gas-vesicle of Sea-
 weed, 304
Mutinus caninus, Deformation of Egg, 78
Mya arenaria, History, 566
 Mycetozoa, British, Exhibition by A. E.
 Hilton, 802
 — of Ceylon, 360
 — of the Midland Plateau, 634
 — Text-Book, 220
 — *See* CONTENTS
 Mycetozoan Parasites, 221
 Mycological Fragments, 78
 — Notes, 211, 486
 — — II., 629
 — — No. 33, 78
 — — No. 34, 354
 Mycology, British, 492
 Mycorrhiza of Fruit-trees, 493
 — of *Sempervivum*, 216

- Mycosis, New Variety occurring in Man, 637
 Myeloxylon, Wounded, Note, 599
 Myiasis Narium, 716
 Mylnis, F., Micro-chemical Tests for Identifications of Varieties of Glass, 768
 Myrientomata, Monograph, 33
 Myriopoda. *See* CONTENTS
 Myrmecophila, Biology, 28
 Myxobacteriaceæ and Bacteriaceæ, Comparative Studies, 88
 Myxomycetes of Brandenburg, 496
 — of Picton County, 756
- N
- Nachet, —, Ocular Micrometer with Interior Vernier, 230
 Naef, A., Development of Cœlomic and Vascular Systems in *Loligo*, 161
 Nageotte, Y., Method of Preparing Frozen Sections of Brain-substance, 378
 Nägler, K., New Spirochæt from Fresh-water, 42
 Nails of Primates, 299
 Nakazawa, R., *Rhizopus Batatas*, a New Koji Fungus, 72
 Namyslowski, B., Actinomyces of the Cornea, 86
 — Two Epidemic Mildew Diseases, 482
 Nash, G. N., Ferns of New York Botanical Garden, 339
 Natantia, Decapod, of Coasts of Ireland, 576
 Naumann, R. O., Protozoon Parasites in Blood of Fishes, 589
 Nauplius, Double, 34
 Navas, L., Lichens of the Azores, 359
 Navas, P. L., Lichens of Aragon, 495
 Neger, F. W., Seed-gathering Ants, 304
 Nègre, L., Intestinal Stage of Sarcosporidium, 730
 Negri, G., Bryophyta of Ruwenzori, 58
 Neisser, M., Bacteriological Demonstration Table, 761
 Neisser's Staining for Diphtheria Bacilli, Modification, 522
 Nelson, E. M., A Micrometric Difficulty, 696, 707
 — Critical Microscopy, 282, 395
 — Examination in Microscopy, 771
 — Grayson's Photomicrographs of his Rulings, 701
 — "On an Apparatus for Increasing the Power of an Achromatic Condenser," 534
 — On the Resolution of New Detail in a *Coscinodiscus asteromphalus*, 698, 797
 — On the Visibility of the Tertiaries of *Coscinodiscus asteromphalus* in a Balsam Mount, 147, 270
 Nelson, E. M., What did our Forefathers see in a Microscope? 427
 Nelson, E. W., Artificial Culture of Marine Plankton Organisms, 374
 — Rearing Marine Larvæ, 563
 Nematocysts, Development, 462
 Nematode Development, Significance of Chitin, 722
 — New from Trinidad, 583
 Nematodes, Adaptation to Temperature of their Hosts, 458
 — Free-living, Hermaphroditism among, 722
 — New, 36
 — of the Eye, 317, 458
 — of Red Grouse, 171
 — Studies, 36
 — Subcuticula and Lateral Areas, 170
 Nematohelminthes. *See* CONTENTS
 Nemertean, Fresh-water, Protective Encystation, 319
 — Summer and Winter Spawning, 320
 Nemerteans, Antarctic, 460
 — Fresh-water, 460
 — from Eastern Indian Ocean, 319
 — Regeneration, 319, 723
 Nemiloff, A., Studying the Varicosities on Non-medullated Nerve-fibres, 383
 Nephridia of *Dinophilus* and of Larvæ of *Polygordius*, *Echiurus* and *Phorouis*, 316
 Nephridium, Development in *Amphioxus*, 443
 Nephrocytes and Pericardial Cells of Orthoptera, 31
 Nephrothium and Dryopteris, Imbedded Antheridia, 50
 Neppi, V., Medusæ of the Gulf of Trieste, 323
 Neresheimer, E., Fresh-water Lernæopodidæ, 314
 Nerve, Eighth Cranial, Peripheral Terminations, 154
 — Mesencephalic, in *Ammocœtes*, 161
 — Motor, Segmental Structure of Plexus in Elasmobranchs, 449
 — Terminations, Peripheral, Demonstrating, 115
 Nerve-cells, Giant, and Fibres of *Halla*, 457
 — Granules in, 445
 Nerve-endings in Frog's Skin, 297
 Nerve-fibres, Non-medullated, Studying the Varicosities, 383
 Nerve-tissues, Embryonic, Staining, 382
 Nerves, Cranial, Development in Birds, 443
 — — of Pike, 295
 — Peripheral, Method of Staining, 256
 Nervous Mechanism, Autonomic, of Birds' Alimentary Canal, Development, 294
 — System, Influence on, of Extirpation of Limb-primordia in Frog Embryos, 706

- Nervous System of Anemones, 176
 — — of *Ascaris*, 170
 — — of *Hydra*, 175
 — — of *Polystomum integerrimum*, 582
 — — of Vertebrates, New Methods of Investigating, 249
 — — Study, 154
 — — Sympathetic of Crustacea, 573
 — — — Role of Vagi in Development, 295
 — Tissues, Staining with Methylene-blue, 785
- Nesting Habits of *Bembex nubilipennis*, 713
 — — of *Phyllomedusa savugii*, 448
- Nests, Ants', 305
- Neurofibrils, Function, 709
 — in *Lumbricus*, Studying, 376
- Neuroglia, Preparation and Staining, 776
- Neuroptera, Genital Apparatus, 309
 — Irish, 166
- Newt without Lungs, 711
- Nichols, G. E., Critical Mosses of New England, 611
 — Morphology of Juniper, 467
- Nicholson, W. E., New Hybrid Moss in Sussex, 342
- Nickel and Cobalt, Magnetic Transformation, 124
 — and Copper Alloys, 387
 — Phosphides, 388
- Nickel-carbon Alloys, 525
- Nicol, New, for Projection Purposes, 652
- Nicolas, G., Respiration of Vegetative Organs of Vascular Plants, 333
- Nicoloff, T., Youth-form of Leaves and its Significance, 592
- Niedermayer, A., Tetraplatia, 728
- Nienburg, W., *Cystosira* and *Sargassum*, 479
- Nieuwland, J. A., Hints on Collecting and Growing Algae, 198
 — "Knee-joint" of *Mougeotia*, 203
- Nile-blue Staining for the Demonstration of Metachromatic Granules, 381
- Nitrogen and Metals at High Temperatures, 678
 — Thermometer, 265
- Nitroso-bacteria, Biological and Chemical Studies, 635
- Noctuidæ, Abdominal Sensory Organ, 30
- Non-ferrous Metals, Properties, 794
- Non-magnetic Elements, Magnetic Character of Compounds, 264
- Nordenskiöld, E., Structure of *Ixodes redivivus*, 312
- Nordhausen, M., Cryptostomata and Conceptacles of *Fucus vesiculosus*, 743
- Norman, A. M., Polyzoa of Madeira, 37
- Notochord, Study, 157
- Novak, J., Detection of Tubercle Bacilli in the Placenta, 785
- Nowikoff, M., Eyes of Placophora, 162
 — Structure of Bone in Sun-fish, 708
- Nowin, N., Tactile-cells of Grandry's Corpuscles, 445
- Nuclear Division, New Mode, 20
 — Structure, 444
- Nuclei, Changes, in Varying Physiological Conditions, 155
- Nucleus and Chromatophores, Connecting Threads, 329
 — and Cytoplasm Relations, 444
 — of Amœba, 728
 — Role in Heredity, 442
- Nudibranchs, New Genus, 566
- Nuphar, Callus-formations, 466
- Nusbaum, J., Development of Endoderm in Mole-cricket, 166
 — Regeneration in Nemerteans, 319
- Nutrition and Growth of Seed Plants.
 See CONTENTS
- Nutting, C. C., Theory of Abyssal Light, 562
- Nymphaeaceæ, Embryology, 47
- O
- Oak Mildew, 482, 624, 747
- Oats, Cultivated, Origin, 185
- Obel, P., Formation of Oogonia in *Achlya*, 744
- Oberhauser Georges and Trécourt, Old Achromatic Microscope, 640
- Oberhoffer, P., Alloys of Iron, 262
 — Importance of Metallography in the Iron Industry, 392
 — Metallographic Observations at High Temperatures, 264
- Objectives, $\frac{1}{8}$ and $\frac{1}{15}$, Watson's, 226
 — Watson and Sons' Parachromatic, 651
 — See CONTENTS
- Ocular, Petrographic, F. E. Wright's New, 508
- Odiopsis taurica*, 75
- O'Donoghue, C. H., Abnormalities in Frog's Circulation, 449
- Odoriferous Organs in Female Lepidoptera, 165
- Ocophylla smaragdina*, Habits, 304
- Edocephalum glomerulosum*, the Conidial Form of *Pyronema omphalodes*, 75
- Oenothera*, Chromosomes, 43
- Œstlund, O. W., Outlines of Entomology, 27
- Ogata, M., Studying New Sporozoon in Rat-fever, 246
- Ogilvie-Grant, W. R., Zoology of Ruwen-zori, 161
- Ogilvy, J. W., 394
 — Presentation of Projection Lantern by, 129
- Ohno, Y. K., Morphology of Cholera Vibrios in Peptone Solutions of Different Reactions, 364

- Oidium albicans* from Throats, Cultivation, 375
 Oka, A., Japanese Leeches, 458
 Okajima, K., Sensory Organs of Onychodactylus, 445
 Okamura, K., Japanese Algæ, 199, 346, 622
 — — Bryophytes, 613
 Olenellus and other Mesonacidae, 718
 Olfactory Organ of Teleosteans, 160
 — — So-called, in Cephalopods, 302
 Oligochaet, Distomid Cyst in Blood-vessels, 459
 Oligochaets, Regeneration, 577
 Olsen, J. C., Cementation by Gases, 791
 Onchocerca, Genus, 317
 Onnes, K., Magnetic Properties of Manganese, Vanadium, and Chromium, 526
 Onoclea, Monœcious Prothallia, 338
 — Sex of Gametophyte, 733
 Ontogeny and Phylogeny of Hydroids, 585
 Onychodactylus, Sensory Organs, 445
 Oogenesis in *Dytiscus marginalis*, 166
 — in Radiæ, 443
 — of Hydra, 175
 — of Sagitta, 316
 Oogonia, Formation in Achlya, 744
 Ookinesis in *Cerebratulus lacteus*, 320
 Oospheres in Sargassum, 69
Opalina dimidiata, Tentacle-like Processes, 41
 Opercularia, New Species, 41
Ophiocoma pumila, Regeneration, 174
 Ophioglossaceæ, Fertile Spike, 186
 Ophioglossum, Common, New Variety, 338
 Ophiurans of San Diego, 174
 Ophiuroid, Infection with Rhopalura, 726
 Ophiuroids, Luminosity, 38
 Optics, Geometrical, Southall's Principles and Methods, 767
 — Microscopical. See CONTENTS
 Orchids, Root-fungi, 82
 Order, New, of Asteroids, 726
 Organisms, Marine, Reaction to Light and Phosphorescence, 155
 Organogenetic Capacity, 704
 Orthomnion and Mnium, Accessory Leaves, 55
 Orthoptera, Nephrocytes and Pericardial Cells, 31
Orthothecium strictum or *O. rubellum*, 343
 Orton, J. H., Hermaphroditism in *Crepidula fornicata*, 163
 Os Clitoris and Os Penis in Apes, 299
 Os Penis and Os Clitoris in Apes, 299
 Osmond, F., Constituents of Steel, 122
 Osmotic Pressure in Plants, 593
 Osmunda, Chromosomes, 187, 330
 — *cinnamomea*, Stele, 595
 Osmundacæ and Zygopteridæ, Fossil, 596
 — Foliar Gaps, 186
 — Fossil, 595
 Ossification of Human Lower Jaw, 443
 Ostenfeld, C. H., *Biddulphia sinensis*, 66
 — — in the North Sea, 201
 — Phytoplankton of Victoria Nyanza, 201
 — Swiss Plankton, 201
 Osteological Specimens, Preparation, 523
 Osterwalder, A., Causes of certain Plant Diseases, 88
 Ostracods, Fresh-water, Structure, 576
 Ottley, A. M., Gametophytes and Fertilisation in Juniperus, 45
Ourococcus bicaudatus, 203
 Ova, Sea-urchin, Experiment, 584
 Ovarian Glands, 17
 Ovary, Mammalian, Structure, 17
 — State during Pregnancy, 441
 Over-hardening, Removing in Anatomical and Histological Preparations, and New Method of Silver Impregnation, 674
 Oviduct of Domestic Fowl, Ligaments, 447
 Ovule, Gametophytes, and Embryo of Widdringtonia, 46
 Ovum, Cerebratulus, Experiments on Cleavage, 582
 — Fertilised, Male Mitochondria, 557
 — of Ctenophore, Cleavage, 585
 — Polynuclear, in Bat, 294
 Owenia, Musculature, 169
 Oxner, M., Regeneration in Nemerteans, 319, 723
Oxyrrhis marina, 204
 Oyster-eating Fishes, 711
 Ozoux, M., Filaria in Turkey's Eye, 722
- P
- Pace, L., Peculiar Fern Prothallia, 599
 Pacottet, P., Vine Roesleria, 623
Palæmonetes varians, Variability, 313
 Palatal Region of Axolotl, Transformation, 301
 Palatine and Pterygoid Bones in Axolotl, 301
Palinurus vulgaris, Distribution in British Waters, 313
Pallavicinia Flotowiana in Scotland, 736
 Palm Coccaut, *Fomes lucidus*, a Root-disease of, 486
 Palmellaceæ, *Coccomyxa subellipsoidea*, New Member, 61
 Palmer, T. C., New Diatom, 743
 — *Stauroneis Terryi*, 742
 Palschewska, I. v., Examining the Structure of Human heart-muscle, 252
 Panayotatou, A., Isolation of Cholera Vibrios, 663
 Panisset, L., Testing for Indol in Microbic Cultures, 373
 Pannain, E., Physical Properties of Alloys, 260
 — Silver Coinage Alloys, 119

- Panschin, B. A., Cranial Nerves of Pike, 295
- Pantel, T., Adaptations of Parasitic Diptera, 453
- Pantopod, Ten-legged, 717
- Papillæ, Epidermic, in Euproctus, 154
- Paraboloid, Immersion, Watson and Sons' Holos, 231
- Paraffin Baths, Ordinary, Adaptation for Vacuum Embedding, 805
- Blocks, Cooling, 380
- Imbedding in Vacuo, Simple Method, 255
- Paramecium, Life-cycle, 179
- Paramecia cuvieri* in Scottish Waters, 456
- Parasite, New, on *Gracilaria confervoides*, 619
- Parasites from Fishes from Irish Sea, 581
- from Tench, Two New, 42
- Hymenopterous, Studies, 27
- Mycetozoan, 221
- New, in Bulbul's Blood, 729
- — of Dendrocœlum, 41
- of Birds allied to Grouse, 172
- of Labridæ, 728
- Protozoon, in Blood of Fishes, 589
- Parasitic Turbellarians, 582
- Parasmilia, Growth-stages, 177
- Paravertex cardii*, 171
- Pardi, F., Clasmatocytes, 558
- Paris, E. G., Chinese Muscinæ, 345
- Moss-flora of the Isle of Pines, 345
- Paris, P., Hybridisation of Wolf and Dog, 444
- Parker, G. H., Reactions of Sponges, 586
- Parker, J. B., Nesting Habits of *Bembex nubilipennis*, 713
- and others, Plant Diseases, 630
- Parthenogenesis, Alleged Influence of Electric Discharges in Inducing, 293
- Artificial, in Aricia, 35
- — of Frog's Eggs, 706
- in *Dinophilus conklini*, 316
- Partridge, Chinese, Leucocytozoon, 40
- Pascher, A., Chryomonadinæ of Bohemia, 203
- Formation of Colonies in Flagellatæ, 741
- New Genus of Chryomonadinæ, 203
- Three new Chryomonads, 346
- Paton, M. P., Junction of Papillary Muscle and Chordæ Tendinæ, 155
- Paul, G., *Phascolosoma minutum*, 316
- Pavolini, A. F., Development of the *Æciliium*, 627
- Pax, F., Studies on Actinians, 322
- Pearl, M. D., Variation in Comb of Domestic Fowl, 23
- Pearl, R., Cumulative Effect of Selection, 560
- Fertility and Hatching of Eggs, 555
- Reproduction in the Domestic Fowl, 556
- Pearl, R., Use of Selection Index Numbers in Breeding, 296
- Variation in Comb of Domestic Fowl, 23
- Pearl-inducing Worm, Adult of, 723
- Pears, Phythophthora Disease, 487
- Pearse, A. S., Reactions of Amphibians to Light, 559
- Sex Recognition in Crawfishes, 312
- Pecten, Studying Eye, 376
- Pedalion oxyure*, 129
- Pedicellariæ, Gemmiform, 461
- Pebbles, F., *Sphærella lacustris*, 62
- Pellegrin, J., New Parasitic Fish, 159
- Pellini, G., Mixed Crystals of Sulphur and Tellurium, 262
- Pelourde, F., Structure of Fossil and Living Ferns, 49
- Pelseneer, P., Commensal Lamellibranchs, 303
- Penæacea, Embryology, 183
- Penard, E., Mastigamoebæ, 327
- Pénau, H., Yeast-cells of *Endomyces abiciens*, 625
- Penguin, Development, 444
- Penicillium, Culture Studies of Species, 625
- Pennatulid, New Gymnoblasic Hydroid Epizoe on, 323
- Pennatulids, Japanese, 804
- Pennington, M. E., Chemical and Bacteriological Study of Fresh Eggs, 635
- Pensa, A., Gelatin Plates for Graphic Reconstruction, 787
- Percival, J., Life-history and Cytology of Potato-wart Disease, 205
- Perez, C., Histology of Metamorphosis, 306
- Metamorphosis of Malpighian Tubes in Muscids, 306
- Studying Metamorphosis of Muscidæ, 376
- Periderm-formation in Filicinean Petioles, 599
- Peridinids, Skeleton, 180
- Perkins, H. F., Notes on Medusæ of Western Atlantic, 463
- Perkins, R. G., Cheap non-vibrating Suspension for Microphotography, 99
- Glycerin-agar in Fifty Minutes, 248
- Peronospora Ficariæ* and *Albugo candida*, Cytology, 622
- Perrier, R., Adaptive Structure of Accra, 713
- Gill of Bulleidæ, 713
- Perrin, A. de, New Species of Rhipidius, 307
- Perrin, G., Fertilisation of Fern-prothallia, 189
- Petch, T., *Fomes lucidus*, a Root-disease of the Coconut Palm, 486
- Mycetozoa of Ceylon, 360
- Petersen, H. E., Fresh-water Phycomycetes, 622

- Petetin, J., Newt without Lungs, 711
 Pethybridge, G. H., Catalogue of Irish Fungi, 629
 Petrographical Microscope, Simple Improvements, 643
 Petromyzon, Metameres, 152
 Petrow, J. P., Russian Bryophytes, 56
 Pettit, A., Coccidian in Bile-ducts of Agama, 328
 — Cultivation of *Leishmanium Donovanii* in Fluid Media, 245
 — Endogenous Multiplication of *Hæmogregarina sebai*, 730
 — New Trypanosome in a Vole, 326
 — Studies on Trypanosomes, 465
 — Trypanosome of Lerot, 729
 Peyer's Patches in Birds, 709
 Peyron, —, Nucleated Red Blood Corpuscles in Blood-vessels of the Hypophysitis, 707
 — Process of Secretion in Human Hypophysitis, 709
 Pflanzenfamilien, Engler's, Supplement, 200
 Phalloids, Synopsis, 78
 Pharynx and Mouth of Hamster, 564
Phascosoma minutum, 316
 Philip, R. H., Diatoms of the Sedbergh District, 615
 — Interesting Diatom near Hull, 66
 Philip, R. W., Detection of Tubercle bacilli in Fæces, 672
 Philonotis, Revision of Species, 473
 Phisalix, Mme., Toxic Action of Mucus of Amphibians, 448
 Phora, Subdivisions of Genus, 716
 Phorid, New, 32
Phorocera serriventris, and other Flies, Viviparity, 165
 Phosphides of Iron, 262, 526
 — of Nickel, 388
 — of Tin, 388
 Phosphor-bronze, 676
 Phosphorescence and Light, Reaction of Marine Organisms, 155
 Phosphorescent Organs of Fishes, 21
 Phosphorus, Allotropic Conversion, in the Cardioid-Ultramicroscope, 653
 — Compounds of Cobalt, 261
 Photographic Plates, Resolving Power, 99
 Photography, Macroscopic, Application of Edinger's Drawing and Projection Apparatus, 230
 — with Ultra-violet Light, 766
 Photomicrographs, Grayson's, of his Rulings, 701
 — Instantaneous, Simple Method of obtaining, 807
 — of Diatoms by T. W. Butcher, 801
 Photomicrography, Practical, 656
 — with Axial Cone Illumination, Method of Estimating the Exposure, 369
 — Use of a Metallic Electric Arc, 806
 Photomicrography. See CONTENTS
 Phycoerythrin, 195
 Phycomycetes, Fresh-water, 622
Phyllirhoe bucephala, Luminosity, 565
 Phyllocoïdæ, Pelagic, of Irish Coasts, 169
 Phylloglossum, Morphology, 468
Phyllomedusa savagii, Nesting Habits, 448
 Phylogenesis in Yeasts, Notes, 75
 Phylogenetic Classification of Mosses, 735
 Phylogeny and Ontogeny of Hydroids, 585
 — of Amphidiscophora, 39
 — of the Archegonium, 735
 — of the Filicales. I. Plagiogyria, 469
 — of Trachææ in Araneæ, 311
 Physical Laboratory, National, 794
 Physiology of Seed Plants. See CONTENTS
 Phytophthora Disease of Pears, 487
Phytophthora infestans, 481
 Phytoplankton of the English Lake District, 63
 — of Victoria Nyanza, 201
 Pictet, A., Minute Structure of Food Canal in Cyprinoid Fishes, 20
 Piedaller, A., New Species of Monascus, 745
 Pielsticker, E., *Bacterium anthroposepticum*, 637
 Pierce, W. D., Revision of Order Strepsiptera, 309
 Pieron, H., Topographical Memory in Limpet and in Calyptrææ, 26
 Pigeons, Expression of Emotions, 561
 Pigment-formation and Light, in Crenilabras and Hippolyte, 719
 — — Studying the Relation between, in Crenilabras and Hippolyte, 773
 Pigments, Vegetable, 786
 Pike, Cranial Nerves, 295
 Pinakodendron, Structure and Position, 192
 Pine-seeds, Vitality, 47
 Pine-wood Disease, 488
 Pineæ, Wood Structure, 44
 Pinnoteræ, New Species, 168
 Pintner, T., Posterior End of Rhynchobothrus Chain, 172
 Piophilæ Larvæ in Cheese, 571
 Piroplasma of Hedgehog, 180
 Piroplasmidæ, 730
 Pirotta, R., Ferns of Ruwenzori, 53
 Placenta, Detecting Tubercle Bacilli, 785
 Placentation in Tatu, 153
 Placophora, Eyes, 162
 Plague Bacilli, Granules, 86
 Planarians, New, 171
 Plankton around South End of Isle of Man, Intensive Study, 562
 — Fresh-water, 65
 — Indian Ocean, 200
 — New Method of Fixing, 375
 — Organisms, Marine, Artificial Culture, 374

- Plaukton, Swiss, 201
 Plant Diseases, 213, 356, 488, 630, 752
 — — American Text-book, 630
 — — Causes, 88
 — — Review, 629
 — — Text-book, 487
 Plant, M., Physiological "Separating-Layers" in Gymnosperms, Equisetaceæ, and the Bryophytes, 330
 Plants, Ancestry, 733
 — and Ants, 452
 — Diseases, 79
 — Osmotic Pressure, 593
 — Parasitic, Germination, 332
 — Vascular, Respiration of Vegetative Organs, 333
 Plasma-cells and Mast-cells, 155
 Plasmatide, Development, 571
Plasmodiophora Brassicæ, 496
 Plasmodiophoraceæ, 634
 Platyterium, Two Species, 601
 Platyhelminthes. *See* CONTENTS
 Pleochroic Halos, 243
 Plessis, Du, Life-cycle of Eleutheria, 323
 Pleurococcaceæ, New Genus, 202
 Pleurodeles, Skin, 445
 Pleuroperitoneal Cavity in Birds, Development of Subdivisions, 151
 Pleurosigma, Fresh-water, with Oblique Striæ, 799
 Plumage of Hybrids between Guinea Fowl and Fowl, 444
 Pocock, R. L., Agriotype of Domestic Asses, 158
 — Colours of Equidæ, 22
 Podocarpineæ. Morphology and Relationships, 731
Podoscypha undulata, 77
 Podpera, J., Moss-flora of Moravia, 57
Pohlia carnea in Transylvania, 609
 — Some Critical Species, 60
 Polar Bodies in *Arion empiricorum*, 26
 Polarimeter for Measurement of the Refractive Index of Opaque Bodies, New Form, 93
 — Half-shadow, Zehnder's New, 227
 Polariscope, Use of in Testing High-tension Insulators, 98
 Pollicard, A., Vital Staining of Trypanosomes, 384
 Pollen, Quick Method of Preparing and Staining, 380
 Pollination-mechanism in *Ricinus*, 332
 Poluszyński, G., Abnormalities in Genital Ducts of *Helix pomatia*, 303
 Polychætes, American, 315
 Polychætes from Atlantic adjacent to Ireland, 457
 — Peruvian, 35
Polychærus caudatus, Structure, 459
Polydesmus, Structure, 310
Polypodium Brunei, Tubers, 734
 — *vulgare*, Varieties, 601
 Polyscopic Cell, 673
Polystomum integerrimum, Eyes, 582
 — — Nervous System, 582
 Polytrichaceæ, 343
 — Mechanism of Leaf-movements, 735
 — of Western North America, 738
 Polyzoa, Fresh-water, Australian, 320
 — of Madeira, 37
 Polyzoon on *Pontobdella*, 460
 Pond-life Exhibition, 798
Pontobdella muricata, Trypanosome in Alimentary Tract, 326
 — Polyzoon on, 460
 Poole, M., Development of Subdivisions of Pleuroperitoneal Cavity in Birds, 151
 — Madrepোরaria from Mergui, 463
 — Studying the Development of *Aplysia punctata*, 774
 Popovici-Bazosanu, A., Larvæ of *Megatoma undata*, 452
 Porcher, C., Testing for Indol in Microbic Cultures, 373
 Porifera. *See* CONTENTS
 Porter, —, Aloys Sodiro, 192
 Porter, A., *Bacillus arenicolæ*, 86
 — Disease in *Arenicola*, 35
 — Studying Structure and Life-history of *Crithidia melophagia*, 664
 Porter, A. E., Detection of Tubercle bacilli in Fæces, 672
 Porter, H. L., Properties of Gold-leaf at High Temperatures, 387
 Portevin, A., Hardness of Quenched Steels, 391
 Portevin, A. M., Special Ternary Steels, 121
 Post-antennary Organ of Collembola, 453
 Post-embryonic Development of Unionidæ, 164
 Potato-wart Disease, Life-history and Cytology, 205
 Potatoes, Bacterial Disease, 499
 Potebnia, A., Contribution to the Microfungus Flora of Central Russia, 355
 Potter, —, and others, British Mycology, 493
 Potts, F. A., Hermaphroditism among Free-living Nematodes, 722
 Poyser, W. A. and others, North American Ferns, 51
 Pratt, H. S., Cuticula and Subcuticula of Trematodes and Cestodes, 318
 Prawn, Blind, from Galilee, 313
 Predtjetchensky, W., Bacillus of Typhus Fever, 638
 Pregnancy, Leuco-reaction, 296
 Preparation and Staining of Neuroglia, 776
 Preparing Objects. *See* CONTENTS
 Preservative Fluids. *See* CONTENTS
 President, The, 129, 130, 134, 266-269, 272, 532-534, 536, 801-804, 806

- President, The, Japanese Pennatulids, 804
 — — Notes on *Dendrobrachia fallax* a Rare and Divergent Antipatharian, 266
 — — On some Aleyonarians collected by Sir Ernest Shackleton's Antarctic Expedition, 533
 President's Address, 134, 137
 Pressure, Influence on the Boiling-points of Metals, 531
 Preston, H. B., New Bivalves from Falkland Islands, 304
 Preuss, E., Mounting of Metal Sections, 528
 Price-Jones, C., Development of Red Blood Cells in Chick, 151
 — Studying Development of Red Blood Cells in the Chick, 114
 Primates, Nails, 298
Primula sinensis, Giant and Ordinary, Histology, 331
 Pringsheim, —, Ferments of Fungi, 212
 Pringsheim, E., Red Yeast, 747
 Pringsheim, E., jun., Pringsheim's Yellow Filters, 96
 Printing on Sensitized Papers, 765
 Pristis, Rostral Teeth, 301
 Pritchard, Andrew, Live-box, made by, 269
 Proca, G., *Cladothrix stereotropa*, 222
 — — *vaccinæ*, 365
 Projection Purposes, New Nicol, 652
 Propagules and Protonema in Hepaticæ, 605
Prosorochmus claparedi, Hermaphroditism, 725
 Proteocephalus, New Species, 582
 Prothallia, Fern, Culture, 600
 — — Peculiar, 599
 — Monœcious, in Onoclea, 338
 — of Anemia and Lygodium, 337
 Prothallial Development in Lycopodium, 597
 Prothallium and Embryo of Danaea, 50
 Protists, Locomotion, 465
 Protococcaceæ, 202
 Protonema and Propagules in Hepaticæ, 605
 Protoplasm, Selective Absorption of, and Function of the Endodermis, 591
 Protopteris and Lepidosiren, Development of Alimentary Canal, 295
 Protozoa, Parasitic, Notes, 327
 — Shaking Experiments, 325
 — Treatise, 325
 — See CONTENTS
 Protozoan Parasites in Blood of Fishes, 589
 Prowazek's Bodies, Staining, 787
 Przibram, H., Organogenetic Capacity, 704
Pseudalius, New Species, 722
Pseudaxoid Genus, New, *Dendroorgia*, 323
Psilotum flaccidum, Structure, 469
 Ptarmigan, Adaptation to High Altitudes, 711
 Pteridophyta of Malta, 190
 — See CONTENTS
 Pteridophytes of Ohio, 340
 Pterobranchia, Indian Ocean, 320
 Pterygoid and Palatine Bones in Axolotl, 301
 — Mammalian, Homologies, 447
Pulex cheopis in Hamburg Docks, 31
 Pulfrich, C., Pulfrich's Stereo-Komparator, 233
 Pulmonary Cavity in Slug, Development, 25
 Punnct, R. C., Nemerteans from Eastern Indian Ocean, 319
 Pupæ, Assimilation of Carbon-dioxide, 306
 Purcell, W. F., Development and Origin of Respiratory Organs in Araneæ, 310
 — Phylogeny of Tracheæ in Araneæ, 311
 Pushin, N. A., Alloys of Silver with Zinc, 260
 Putzu, J., Detection of Echinococcus Disease, 459
 Pyramidellidæ, West American, Monograph, 164
Pyronema omphalodes, *Edocephalum glomerulosum* the Conidial Form of, 75
 Pyrophilous Fungi, Studies, 623
- Q
- Quekett Microscopical Club, 108, 245, 518, 771
 Quidor, A., Protandrous Hermaphroditism in Lernæopodidæ, 720
 Quidor-Nachet Microscope, 649
 Quinoue, Fixation of Algae by means of, 521
- R
- Rabbit, Involution of Thymus, 150
 — and Hare, 710
 Raciborski, M., Exobasidium on Azalea, 77
 Racovitza, E. G., Revision of Moulistriini, 456
 Radley, P. E., Vote of Thanks to, 136
 Raiadæ, Oogenesis, 443
 Railliet, A., Genus *Onchocerca*, 317
 — Nematodes of the Eye, 317, 458
 Rails, Steel, Defects, 263
 Ranojevic, N., Servian Fungi, 628
 Ransom, B. H., Tapeworms of North American Birds, 319
 Ranzel, F., Detection of Tubercle Bacilli in the Placenta, 785
 Rat, Early Stages in Development, 442
 — Method of Examining Embryos from the Maternal Tissues, 246

- Rat-fever, New Sporozoon, Studying, 246
 Rat-flea, Transmission of *Trypanosoma lewisi*, 326
 Rat-fleas, 571
 Rat-louse in *Trypanosoma lewisi*, 41
 Ratel, Change of Colour, 448
 Rathbun, M. J., Rare Decapods, 718
 Rathery, F. Mitochondria of Hepatic Cells, 558
 Ratin-bacillus, Relation to the Bacilli of the Gaertner Group, 89
 Rats, South African, Struggle for Existence among, 23
 Rawitz, B., New Methods of Investigating the Central Nervous Systems of Vertebrates, 249
 Raybaud, A., Rat Flea capable of Biting Man, 307
 — Rat-fleas, 571
 — — at Marseilles, 307
 Raybaud, L., Experiments with Mucorini, 349
 Razors, Theory and Practice of Sharpening, 777
 Reconstruction, Graphic, Gelatin Plates for, 787
 Reed, H. S., Chemical Reagents in Relation to Wheat-seedlings, 334
 Reese, A. M., Brain of American Alligator, 561
 Refraction Index of Liquids, Measurement by the Microscope, 243
 — Measurements of the Absolute Indices in Strained Glass, 766
 Refractive Index of Canada Balsam, 372
 — Indices, Additional, of Quartz, Vitreous Silica, Calcite, and Fluorite, 766
 Regan, C. T., Caudal Fin of Elopidae and some other Teleosteans, 449
 — Species of Three-spined Sticklebacks, 159
 Regeneration in Enteropneusts, 173
 — in Hepaticæ, 472
 — in Nemerteans, 723
 — in *Ophiocoma pumila*, 174
 — of Lumbricidæ, 315
 — of Nemerteans, 319
 Reid, D. J., Method of Estimating the Exposure in Photomicrography, with Axial Cone Illumination, 369
 Renauld, F., 739
 — Mosses of Madagascar, 739
 — Notes on Drepanocladus, 343
 — Proper value of a Species, 341
 — Some Forms of Drepanocladus, 60
 Renaut, J., Hyaline Cartilage in Mammals, 446
 Renier, A., Structure and Position of Pinnakodendron, 192
 Renner, O., Lithocysts in Ficus, 466
 — Transpiration, 467
 Rennet-forming Cocci in Cheese, 757
 Repaci, G., *Bacillus moniliformis*, 361
 Repaci, G., New Anaerobic Streptococcus, 364
 — *Streptobacillus niger gangræne pulmonaris*, 222
 Reproduction, Sexual, Nuclear Phenomena in Fungi, 751
 Reproductive Organs in Frog, Abnormal, 19
 — — of Free-Martin, 296
 Reptiles and Amphibians of Jamaica, 448
 — of Mexiana, 300
 — Thymus, 20
 Resolution of New Detail in a *Coscinodiscus asteromphalus*, 698, 797
 Resolving Power of Photographic Plates, 99
 Respiration in Lizard, Mechanism, 158
 — of Vegetative Organs of Vascular Plants, 333
 Respiratory Organs in Araneæ, Development and Origin, 310
 — — in Crustaceans, Minute Structure, 33
 Retterer, E., Mammalian Red Blood Corpuscles, 297
 — Mucous Epithelium, 445
 — Nature of the Bursa Fabricii, 709
 — Peyer's Patches in Birds, 709
 — Red Blood Corpuscles of Mammals, 708
 Reuter, E., New Mode of Nuclear Division, 20
 — Structure and Development of Mites, 33
 Révillon, L., Steels for Gears, 120
 — Zinc Bronzes, 677
 Revis, C., Stability of the Physiological Properties of Coliform Organisms, 362
Rhabditis brassicæ, Structure and Life-history, 36
Rhabdomolgus Novæ-Zelandiæ, Systematic Position, 38
 Rheinberg, J., 126, 271, 806
 Rhinophis, Egg, 294
 Rhipidius, New Species, 307
 Rhizocephala, Notes, 34
 Rhizoids of Marchantiales, 605
 Rhizophore of Selaginella, 599
Rhizopus Batatas, a New Koji Fungus, 72
 Rhopalura, Infection of Ophiurid, 726
 Rhyncobothrius Chain, Posterior End, 172
 Ribs of Urodela, 159
 — Sacral, Morphological Significance, 157
 Ricciaceæ, Development of Air-chambers, 340
 Rich, F., Fresh-water Algæ in Nature, 199
 Richter, O., Physiology of Diatoms, 67, 615
 Richters, F., Studies in Tardigrada, 173
 Ricinus, Pollination-mechanism, 332
 Riquier, J. K., Larva of Echinorhynchus in Tench, 37
 Ritchie, J., Distribution of *Palinurus vulgaris* in British Waters, 313
 — *Holothuria forskali* in Scottish Waters, 462

- Ritchie, J., *Paramola cuvieri* in Scottish Waters, 456
 — Two Unrecorded 'Challenger' Hydroids, 463
 Ritter, W. E., Study of a Tunicate, 450
 Roaf, H. E., Digestion in Marine Invertebrates, 561
 Robertson, M., Ichthyosporidian Disease in Sea Trout, 181
 — Trypanosome in Alimentary Tract of *Pontobdella muricata*, 326
 Robinson, M., Reproduction of *Kalpidorhynchus arenicolæ*, 465
 Rocking-microtome, Van der Stad's Improved, 665
 Rodents, Development of Wolffian and Müllerian Ducts, 150
 Rodenwaldt, E., New Trematode from Man, 37
 — *Trypanosoma levisi* in Rat-louse, 41
 Roesleria, Vine, 623
 Roestelia, Peridial Cells, 626
 Rogers, C. G., Granules in Nerve-cells, 445
 Rohr, M. v., Binocular Loups of Weak and Medium Magnification, 225
 Röhl, J., Congress Notes, 613
 — Specific Names of Sphagnum, 613
 — Specific Types versus Formenreihen, 613
 Rolland, L., Atlas of Fungi, 211
 Rolling, Effects produced by, 792
 Romanowsky Method, Staining Sections, 384
 Root-fungi of Orchids, 82
 Roots, Studies, 45
 Roscher, P., Mouth and Pharynx of Hamster, 564
 Roscoff Laboratory, 477
 Rosenblatt, —, Resistance of Vegetable Tyrosinases to High Temperatures, 751
 Rosenbusch, F., Encystation in Crithidia, 465
 Rosenhain, W., Copper-aluminium-manganese Alloys, 789
 — Crystalline Structure of Iron at High Temperatures, 389
 — Light Alloys, 677
 Rosenstock, E., New Tropical Ferns, 603
 — Spruce's South American Ferns, 52
 Rosenthal, G., Antagonism of *Bacillus bulgaricus* and *Bacillus diphtheriæ*, 364
 Rosenvingo, L. K., Marine Algæ from North-east Greenland, 478
 — New Parasitic Alga, 742
 Roshardt, P. A., Function of Living Cells in Ascent of Sap, 468
 Ross, H., Otto Sendtner, 739
 Rotatory Method in Microscopy, 256
 Roth, G., *Drepanocladus furcatus*, 60
 — Moss Criticisms, 614
 — New and Rare European Mosses, 194
 Rothmayr, J., Popular Account of Fungi, 750
 Rothpletz, A., Fossil Algæ, 204
 Rotifera, Antarctic, 461
 — Distribution, 173
 — of Turkestan, 173
 — See CONTENTS
 Roule, L., Epidermic Papillæ in Euproctus, 154
 — Study of Notochord, 157
 — Variations in *Tropidonotus*, 23
 Rousselet, C. F., 266, 268, 269, 801
 — Distribution of Rotifera, 173
 — Old Microscope presented by, 642
 — *Pedalion oxyure*, 129
 — Two old Microscopes, 400
 Roussy, A., Development of Fungi on Fatty Substances, 73
 Rouville, E. de, Salivary Juice of Cephalopods, 451
 Row, R. W. H., New Family of Calcareous Sponges, 178
 Rowland's Method for the Concave Grating, An Adjustment for the Plane Grating, similar to, 105
 Ruata, V., *Coccolobacillus conjunctivæ*, 87
 Rubens, H., Measurements in the Long-waved Spectrum, 517
 Rudolfi, E., Thermo-electricity of Alloys, 677
 Ruediger, E. H., Filtration of Immune Sera, 385
 Rugan, H. F., The "Growth" of Cast Irons after Repeated Heatings, 390
 Rulings, Grayson's Photomicrographs, 701
 — Micrometric and Diffraction, On the Production, 239
 — Wave-length, Use of, as Defining Lines on Standards of Length, 107
 Russ, C., Detection of Bacteria by means of an Electric Current, 110
 Russell, E. S., Growth of Limpet's Shell, 163
 — Indian Ocean Alcyonaria, 584
 Russo, —, Determination of Sex, 441
 Russulæ, Classification, 485
 Rust Fungi, Sexuality, 484
 Ruzicka, S., Mixed Crystals or Solid Solutions, 794
- S
- Sabina sabinoïdes*, Whitening of the Mountain Cedar, 746
 Sablon, L. du, Ascent of Sap in trees, 594
Saccorhiza bulbosa, 348
 Sacculina, Twin, 457
 Sack, P., Palaæartic Spongostylinae, 165
 Saedeker, A. de, Oogenesis in Raiadæ, 443
 Sagenopteris and Hydropterangium, 598
Sagitta enflata, 36

- Sagitta*, Oogenesis, 316
 — Primitive Germ-cells, 170
 Sagnac, G., Interferometer with Inverse Superposed Luminous Rays, giving in White Polarised Light a Narrow Central Fringe of Sensible Tint and Narrow Coloured Fringes at White Intervals, 654
 Saint-Hilaire, C., Follicular Epithelium of Cephalopods, 565
 Saito, K., Fermentation Fungi from Korea, 354
Salvadora atra, Abortive Embryo, 152
 — and *Triton alpestris*, Development of Hyobranchial Skeleton, 152
 Salamandrid, Lungless, 24
 Salivary Glands of *Chironomus* Larvæ, Structure of Nucleus in Cells of, 452
 — Juice of Cephalopods, 451
 Salmon, E. S., and others. Plant Diseases, 488
 Salpa Chain, Development, 564
Salvinia natans, Germination, 51
 Sampson, K., Structure of Habits of *Ixodes ricinus*, 168
 Samssonow, N., Identity of Flemming's and Altmann's Granules, 671
 Samut, R., Enumeration of Blood-corpuscles, 231
 Sangiorgi, G., Appearance found in certain Bacteria when examined by the Indian-ink Method, 635
 Sap, Ascent in Trees, 594
 — Function of Living Cells in Ascent of, 468
 Saposhnikoff, A. V., Specific Heat of Metallic Alloys, 528
 Saragnone, E., Fluoride of Silver in Golgi's Method, 256
 Sarcosporidia, Study, 181
 Sarcosporidium, Intestinal Stage, 730
 Sargassum and Cystosira, 479
 — Oospheres, 69
 Saron, Dimorphism of Males, 718
 Sarracenia and Cephalotus, Systematic Relationship, 184
 Sartory, A., Microbes on Fruit, 86
 Saunders, A. M. C., Studying the Development of *Aplysia punctata*, 774
 Sauvageau, C., *Colpomenia sinuosa*, 68
 — *Halopteris scoparia* and *Splacelaria radicans*, 67
 — Hybrid Fucus, 196
 — Marine Algæ and Currents, 198
 — Naturalisation of Algæ, 198
 Saw-fish, Intra-uterine Embryos, 706
 Saxifragaceæ, 330
 Saxton, W. T., Embryology of *Encephalartos*, 331
 — Ovule, Gametophytes and Embryo of *Widdringtonia*, 46
 Sayce, O. A., Terrestrial Species of *Talitrus* from Victoria, 34
 Scales, F. Shillington, 126, 129, 135, 271, 394-396, 536
 Scen-desmus, 62
 Schaeffer, G., Chemical Basis of Gram's Method of Staining, 381
 — Mitochondria of Hepatic Cells, 558
 Schaffer, J., Chordoid Tissue, 708
 Schaffner, J. H., Interesting Botrychium Habitat, 338
 — Pteridophytes of Ohio, 340
 Schaffnit, E., *Coniophora cerebella* as Timber-destroyer, 485
 Schaller, W. T., Refractive Index of Canada Balsam, 372
 Scharff, R. F., Former Land Bridge between Northern Europe and North America, 302
 Schechtel, E., New Hydrachnids, 573
 Schenck, R., Electron Theory and Solid Solutions of Metals, 529
 Schepelew, J., Phosphorus Compounds of Cobalt, 261
 Schepotieff, A., Indian Ocean Pterobranchia, 320
 — New Primitive Insect, 32
 — Studies on Amœbæ, 589
 Schereschewsky, J., Cultivating *Spirochæta pallida*, 111
 Schiffner, V., Bryological Notes, 607
 — Chiloseyphus and Heteroseyphus, 607
 — New European *Frullania*, 342
 — Species of *Anastrophyllum*, 342
 — Rhizoids of Marchantiales, 605
 — Useful Plants among Lichens, 219
 Schikorra, —, Development of *Monascus*, 74
 Schiller, J., Microspore-formation in *Chaetoceras Lorenzianum*, 64
 Schimmer, F., Biology of Myrmecophila, 28
 Schimpff, H., Heat-capacity of Metals and Compounds, 793
Schistosomum japonicum, Life-history, 459
 Schizomycetes. See CONTENTS
Schizoneura paradoxa, 596
 Schizophyta. See CONTENTS
 Schizopods and Cumacea, Autaretic, 575
 — Digestive System, 169
 Schlenner, A., Preparation of Ammoniacal Silver Solution, 786
 Schmidt, E. W., *Oedocephalum glomerulosum*, the Coudial Form of *Pyronema omphalodes*, 75
 Schmidt, F. W., Removing Over-hardening in Anatomical and Histological Preparations, and New Method of Silver Impregnation, 674
 Schmidt, J., Hepaticæ of Hamburg, 194
 — Mosses of Hamburg, 343
 Schmidt, W., Specific and Latent Heats of Molten Cast-iron, 679
 Schmidt, W. J., Integument of *Voeltzkowia mira*, 297

- Schmula, —, Scenedesmus, 62
 Schneider, J., Ultramicroscopic Examination of Colours of Textile Fibres, 770
 Schoop, U., New Method of Coating with Metals, 531
 Schreyer, F., The System Cu_2S-FeS , 261
 Schuberg, A., Nuclear Hypertrophy induced by Mycosporidia, 328
 Schwartz, E. J., Mycetozoan Parasites, 221
 Schweiger, J., Systematic Relationship of *Sarracenia* and *Cephalotus*, 184
 Sclerotic, Structure, 708
 Scorpion, Functions of Lymphatic Gland, 454
 Scott, A., Intensive Study of Plankton around South End of Isle of Man, 562
 Scott, T., Crustacea in Gizzard of Deep-sea Cuttlefish, 314
 Scourfield, D. J., 270
 Screws, Method of Testing, 767
 Scutigera, New, 33
 Sea-anemones, 726
 — and Hermit-crabs, Commensalism, 718
 — Rhythm, 322
 Sea-elephants, Variation in Skull, 710
 Sea-urchin Ova, Experiment, 584
 Seabra, A. F. de, Albinism, 23
 Seal-embryos, 443
 Seaver, F. J., American Hypocreales. III, 350
 — North American Hypocreales, 624
 — Studies in Pyrophilous Fungi, 623
 Seaweeds, Brown, Zoning, 348
 Sections, Celloidin, Fixation, 384
 — — Numbering, 782
 — Frozen, of Brain-substance, Method of Preparing, 378
 — — Mounting, 787
 — Metal, Mounting, 528
 — Microscopical, through both Cerebral Hemispheres, 379
 — Mounted, Device for Protecting during Dehydration, 257
 — Serial Celloidin, Mounting, 787
 — Staining by the Romanowsky Method, 384
 Seed- and Fruit-development, Influence of Light, 593
 Seed-infesting Chalcid Flies, 31
 Seeds of Parasitic Plants, Germination, 332
 — Pine, Vitality, 47
 — Resting, Ferments and Latent Life, 48
 Seidelin, H., Two Filariae in Snake's Blood, 37
 Selaginella, Cones, 598
Selaginella Preissiana, 188
 — Rhizophore, 599
 — Strobilus, 187
 Selby, A. D., and others, Diseases of Plants, 79
 Selection, Cumulative Effect, 560
 Selenew, J. F., Studies on Spirochaetes, 465
 Seminal Vesicles and Infection, 158
 Sempervivum, Mycorrhiza, 216
 Sendtner, Otto, 739
 Senescence, Physiology, 447
 Senn, G., Form and Change of Position of Chromatophores, 329
 — *Oxyrrhis marina*, 204
 — Tubers of *Polypodium Brunnei*, 734
 Sennen, F., New European Fern, 602
 Sensory Organ, Abdominal, in Noctuidæ, 30
 "Separating-Layers," Physiological in Gymnosperms, Equisetaceæ, and the Bryophytes, 330
 Septicæmia Group, Hæmorrhagic, New Bacillus, 497
 Sera, immune, Filtration, 385
 Serirt, M., Lichen-flora of Bohemia and Moravia, 633
 Setchell, W. A., Sphærosoma, 745
 Seydel, E., Byssus-apparatus of Lamellibranchs, 304
 Seymann, W., *Asplenium Lingelsheimi*, a New Hybrid, 601
 Sex, Determination, 441
 — in *Lychnis*, Inheritance, 337
 Sex-cells of Four Species of Cockroaches, Nuclear Components, 31
 Sex-recognition in Crawfishes, 312
 Sexton, E. W., Amphipods from North Side of Bay of Biscay, 574
 Sexual Maturity, Period of in Marine Animals, 302
 — Reproduction, Nuclear Phenomena in Fungi, 751
 Sexuality and Apospory in the Mosses, 340
 — in Mosses, 603
 Shackleton's, Sir Ernest, Antarctic Expedition. Alcyonarians collected by, 533
 — Antarctic Rotifera, 461
 Shad, Aortic Ligament, 159
 Shark, Frilled, Skeleton, 712
 — Porbeagle, Double Egg, 294
 Sharpening Razors, Theory and Practice, 777
 Shattuck, C., Origin of Heterospory in Marsilia, 188
 Shearsby, —, Diatoms for Distribution, 268
 Sheep Disease caused by a Lanceolate Diplococcus, 636
 Shell, Limpet's, Growth, 163
 Sheppard, T., Prehistoric Mosses from Lincolnshire, 736
 — Muscineæ of Yorkshire, 55
 Shipley, A. E., Ectoparasites and Endoparasites of Grouse, 167
 — Nematodes of Red Grouse, 171
 — Parasites of Birds allied to Grouse, 172
 — Relation of Entozoa to Bacterial Disease, 25
 — Tapeworms of Red Grouse, 172
 Shrimps, Snapping, 577
 Shrinkage of Metals and Alloys, 388

- Shukoff, I. I., Magnetic Transformation of Nickel and Cobalt, 124
- Shukow, I., Nitrogen and Metals at High Temperatures, 678
- Shull, A. F., Life-cycle of *Hydatina senta*, 583
- Shull, G. H., Inheritance of Colour in *Lychnis*, 337
— of Sex in *Lychnis*, 337
- Siedentopf, H., Allotropic Conversion of Phosphorus in the Cardioid Ultra-microscope, 653
— Aplanatic, or Cardioid Condenser for Dark-ground Illumination, 515
— Recent Progress in Ultramicroscopy, 654
— Ultra-microscopic Image, 515
- Sievers, F., Absorption of Water by Lichens, 219
- Sieverts, A., Solubility of Gases in Metals and Alloys, 530
- Silberberg, B., Stimulation of Storage Tissue by Zinc Sulphate, 47
- Silicon and Sulphur, Effect on Cast-iron, 678
- Silk-moth, Development of Eggs, 305
- Silks, Natural and Artificial, Diagnosis, 659
- Silkworm Moth, Red Disease, 758
- Silver, Alloys with Zinc, 260
— Coinage Alloys, 119
— Fluoride, in Golgi's Method, 256
— Impregnation, New Method, and Removing Over-hardening in Anatomical and Histological Preparations, 674
— Method, Bielschowsky's, Modification, 670
— Solution, Ammoniacal Preparation, 786
- Silvestri, F., New Millipedes, 310
— Studies on Diplopoda, 168
— on Hymenopterous Parasites, 27
- Simpson, J. J., Asteroids from Portuguese East Africa, 321
— "Hicksonella," a New *Gongonellid* Genus, 681, 796
— Indian Ocean Alcyonarians, 177
— New Pseudaxonid Genus *Dendrogorgia*, 323
— Species of *Cactogorgia*, 323
— Revision of *Gongonellidæ*, 727
- Simulium columbacensis*, Alimentary Tract and Habits, 306
- Sinclair, F. G., Abnormal Pair of Limbs in *Lithobius*, 167
- Sinnott, E. W., Foliar Gaps in the *Osmundaceæ*, 186
- Sintering-point Curve, 392
- Skate Embryos, Hypochord, 152
- Skeleton of Frilled Shark, 712
— of Peridinids, 180
- Skin, Frog's, Nerve-endings, 297
— of *Pleurodeles*, 445
- Skull, Cetacean, Asymmetry, 299
— Marsupial, Development, 18
- Skull of Sea-elephants, Variation, 710
- Slags, Metallographic Study, 794
- Slices, Thin Parallel of Brain Substance, Cutting, 253
- Slides, Microscope, On Labelling, 267
— See CONTENTS
- Slosson, M., *Dryopteris* Hybrids in North America, 471
- Slug, Development of Pulmonary Cavity, 25
- Smallwood, W. M., Granules in Nerve-cells, 445
- Smilacina stellata*, Embryo-sac, 46
- Smith, A. M., Leo Lesquereux, 61
- Smith, C. A. M., Properties of Non-ferrous Metals, 794
- Smith, F. P., Mounting Spider Dissections as Microscopical Objects, 385
- Smith, T., Plea for the Study of Fungi, 750
- Smith, W. G., Coloured Drawings of Mushrooms, Edible and Poisonous, 628
- Smith, W. S., Functions of Yeast, 625
- Smut Infection of Wheat and Barley, 76
- Snail, Double, 713
— Noises made on Window-pane, 303
- Snake, Grass, Development of Vertebral Column, 151
- Snakes and Worms, Association of Barnacles with, 721
- Snessarew, P., Modification of Bielschowsky's Silver Method, 670
- Snodgrass, R. E., Thorax of Insects and Articulation of Wings, 572
- Snow, Green, 203
- Söderlund, G., Involution of Thymus in Rabbit, 150
- Sodirol, Aloys, 192
- Sokolow, I., Luminosity of Ophiuroids, 38
- Solids, Internal Friction at Low Temperatures, 530
- Solfugæ, New Genus, 717
- Solmedia, 372, 393
- Solorina, Genus, Variations of *Gonidia*, 755
- Somatic Modifications in White Mice, and their Reappearance in the Offspring, 706
- Sommerfeld, P., Modification of Neisser's Staining for *Diphtheria Bacilli*, 522
- Sommier, S., Italian Algæ, 346
— — *Muscineæ*, 344
- Sosman, R. B., Nitrogen Thermometer, 265
- Sourek, J., Ultramicroscopic Examination of Colours of Textile Fibres, 770
- Southall, J. P. C., Principles and Methods of Geometrical Optics, 767
- Southern, R., Marine, Annelids of Dublin Bay, 721
— Pelagic *Phyllodoceidæ* of Irish Coasts, 169
— Polychæts from the Atlantic adjacent to Ireland, 457
— Structure and Life-history of *Rhabditis brassicæ*, 36

- Southwell, T., Adult of Pearl-inducing Worm, 723
 — Anomura of Kattiawar, 168
 — Endogenous Multiplication in Larva of *Tetrarhynchus unionifactor*, 723
 — Intra-uterine Embryos of Saw-fish, 706
 — New Species of Pinnotheres, 168
 — Notes on Ceylonese Hermit-crabs, 719
 — Oyster-eating Fishes, 711
 Spark Spectra of Metals, 793
 Spatangus and Echinocardium, Mode of Feeding, 174
 Spätlich, W., Structure of Tetrabothrius, 172
 Spawning of *Hydroides dianthus*, 721
 — Summer and Winter, in Fresh-water Nemertean, 320
 Species, Proper Value, 341
 Spectrum, Long-waved, Measurements in, 517
 Spegazzini, C., Argentine Fungi, 355
 — Chilian Fungi, 628
 Spengler, C., New Type of Tubercle Bacillus, 501
 Spermatogenesis in *Alytes obstetricans*, 152
 — in *Helix*, 303
 — in *Stenobothrus biguttulus*, 32
 — of Fowl, 19
 — of Mnium, 192
 Spermatozoa entering a Blastula, 442
 — Vitality, 20
 Spermatozooids in Marchantia, Chemotaxis, 193
Sphelaria radicans and *Halopteris scoparia*, 67
Sphaerella lacustris, 62
 Sphærocarpos, 474
 Sphærosoma, 745
 Sphagna, British, New Records, 475
 — Manx, Additions, 610
 Sphagnaceæ of Siberia, 195
 Sphagnum, Nomenclature, 193
 — Specific Names, 613
 Spicules, Hexactine, 178
 — Hexactinellid Sponge, and their Names, 324
 Spider Dissections, Mounting, as Microscopical Objects, 385
 Spiders, Behaviour, 454
 — Courtship, 573
 — Nearctic, Catalogue, 454
 — New Cteniform from South America, 310
 — of Spain, 454
 — Spinnerets, Cribellum, and Respiratory Organs, 312
 Spieckermann, A., Bacterial Disease of Potatoes, 499
 Spiers' "Nature through the Microscope," 244
 Spike, Fertile, of the Ophioglossaceæ, 186
 Spinal Marrow Cells, Golgi's Method for Examining the Internal Network, 384
 Spinnerets, Cribellum and Respiratory Organs of Spiders, 312
 Spinoid, Larval, Precocious Maturity, 721
Spirillum volutans, Flagella, 88
 — — Methods of Demonstrating Flagella and Minute Structure, 116
 Spirochaet, New, from Fresh-water, 42
Spirochæta balanitidis and *S. gracilis*, Cultivation, 110
 — *eurygyrata* and *S. stenogyrata*, 86
 — *gracilis* and *S. balanitidis*, Cultivation, 110
 — *pallida*, Cultivating, 111
 — — in Ova of Congenitally Syphilitic Child, 181
 — — Indian-ink Method of Demonstrating, 386
 — *stenogyrata* and *S. eurygyrata*, 86
 Spirochaets, Studies, 465
 Spirula, Young, 451
 Spitta, E. J., 267, 270
 Sponge Spicules, Hexactinellid, and their Names, 324
 Sponges and Algæ, Symbiosis, 480
 — Calcareous, New Family, 178
 — Fresh-water, from the Philippines and Australia, 587
 — Reaction, 586
 — Slime Bacteria, 757
 Spongostylinae, Palearctic, 165
 Sporangium of *Lycopodium pithyoides*, 734
 Spores, Fungus, Wintering, 355
 — in Acid-fast Bacteria, New Method of Demonstrating, 116
 — New Method of Staining, 522
 — Vitality, 491
 Sporogonium and Gametophore of Conoccephalum, 53
 Sporozoon, New, in Rat-fever, Studying, 246
 Spot, Black, in Cheese, 352
 Spring, W., Formation of Alloys by Pressure, 528
 Sputum, New Methods for Examining, 252
 Ssnitzin, D. T., Bucephalus, 459
 Ssnitzin, D. H., Relationships of Digenic Trematodes, 171
 Stabler, George, 242, 477
 Stachyodes, New Species, 177
 Staff, H. v., Structure and Life-history of Fusulinidæ, 464
 Stager, R., New Observations on Ergot, 482
 Stahl, W., Microstructure of Copper, 260
 Stain, New, Dahlia, 786
 Staining and Preparation of Neuroglia, 776
 — Blood Platelets, 783
 — — Smears, 785
 — Deep Colonies in Plate Cultures, Method, 672
 — Embryonic Nerve-tissues, 382
 — Eosinophilous Cells, 118

- Staining for Diphtheria Bacilli. Modification of Neisser's, 522
 — Glycogen, Methods, 381
 — Method of Gasis, Diagnostic Value, 671
 — Modification of Gram's Method, 118
 — Moist Preparations and Sections by Azur-eosin Method, 522
 — Nervous Tissues with Methylene-blue, 785
 — Nile-blue, for the Demonstration of Metachromatic Granules, 381
 — Objects. *See* CONTENTS
 — Peripheral Nerves, Method, 256
 — Pollen, Quick Method of Preparing and, 380
 — Prowazek's Bodies, 787
 — Reaction, New, for Tubercle Bacilli, 117
 — Sections by the Romanowsky Method, 384
 — Spores, New Method, 522
 — the Connective-tissue Framework of Viscera, New Method, 116
 — *Trypanosoma dimorphon*, 672
 — Tubercle Bacilli, Different Methods, 258
 — Vital, of Trypanosomes, 384
 — Wet Films by Giemsa's Azur-eosin Method, 784
 Stains, Hamatin, 786
 Stamm, R. H., Muscle-insertions in Arthropods, 164
 Stampfli, R., Deformations caused by Uredineæ, 209
 Stand, Convenient Form, for Use as Micro-colorimeter and with Micro-Spectroscope, 14, 127
 Stands, Microscope. *See* CONTENTS
 Stanesco, V., Cultivation of *Spirochaeta gracilis* and *S. balanitidis*, 110
 Stansfield, A., Moss-flora of Tolmorden, Lanes, 609
 Starfishes, New, 321
 — North American, Notes, 174
 Staub, W., Black Spot in Cheese, 352
 Stauffer, H., Nuclear Structure, 444
Stauroneis Terryi, 742
 Stead, J. E., Effect of Silicon and Sulphur on Cast-iron, 678
 — Microscopy and Macroscopy in Workshop Practice, 528
 Stebbing, T. R. R., Australian Amphipods, 718
 Steche, O., Phosphorescent Organs of Fishes, 21
 Steel and Iron, Heat-treatment, 262
 — — — Transformations, 123
 — Cementation, 527
 — Cemented, Thermal Treatment, 791
 — Chromium, 790
 — — A_2 Point, 790
 — Constituents, 122-
 Steel, Effect upon, of Sudden Changes of Temperature, 391
 — Gases Occluded, 124
 — Hardness, 123
 — Industry, Application of Titanium Alloys, 792
 — Rails, Defects, 263
 — Strain-disease, 791
 — Testing by Corrosion, 793
 Steels, Carbon, and Cast Irons, Constitution, 790
 — Carbon-tungsten, 391
 — for Gears, 120
 — Quenched, Hardness, 391
 — Silicon, Cementation, 391
 — Special, 120
 — — Heat-treatment, 791
 — — Ternary, 121
 Stegmata in the Hymenophyllaceæ, 187
 Steinbrink, C., Cohesion-mechanism of Moss-leaves, 341
 — Pollination-mechanism in Ricinus, 332
 Steinmann, P., New Planarians, 171
 Stele of *Osmunda cinnamomea*, 595
Stenobothrus biguttulus, Spermatogenesis, 32
 Stephan, S., Modification of Gram's Method of Staining, 118
 Stephani, F., Dendrocera, 475
 — Mexican Hepaticæ, 59
 — Monograph of the Hepaticæ, 55
 Stephens, E. L., Apogamy in *Pteris droog-mantiana*, 470
 — Embryology of Penæaceæ, 183
 Stephens, J., Alcyonarians of Irish Coasts, 177
 Stereo-comparator, Pulfrich's, 233
 Stereo-photomicrographs, Method of Preparing, 233
 Stevens, N. E., Discoid Gemmæ in Foliose Hepatics, 604
 Stewart, F. H., New Gephyrean Type, 579
 Sticklebacks, Three-spined, Species, 159
 Stiles, W., Cones of Selaginella, 598
 — Structure of *Psilotum flaccidum*, 469
 Stinging-cells, Study, 462
 Stirton, J., New Scottish Mosses, 56
 Stitz, H., Genital Apparatus of Neuroptera, 309
 Stober, W. G., and another, Notes on the Larger Fungi, 628
 Stock, A., Sintering-point Curve, 392
 Stockmayer, S., Algae of Trebizond, 691
 Stokey, A. G., Sporangium of *Lycopodium pithyoides*, 734
 Stomata of *Lycopodium annotinum*, 598
 Stomatopods, Japanese, 456
 Stone, G. E., Electricity and Micro-organisms, 496
 Strain, Mechanical, Change of State in Metals under, 529
 Strain-disease in Steel, 791

- Strand, E., New Cteniform Spiders from South America, 310
- Strasburger, E., Characters of Graft-hybrids, 335
- Strauss, E., Eyes of Gammarids, 313
- Streeter, S. G., Influence of Gravity on Growth of *Amanita*, 334
- Strepsiptera, Revision of Order, 309
- Strepsipteron, New, 310
- Streptobacillus niger gangræne pulmonaris*, 222
- Streptobacterium fetidum*, 758
- Streptococcus mucosus*, 501
- Streptothrix, Lactic-acid, New, 221
— *pyogenes* and *Actinomyces hominis*, Comparative Study, 222
- Stress, Alternating, Testing, 124
- Stringer, E. B., Note on the Use of the Mercury Vapour Lamp in observing the Rings and Brushes in Crystals, 440, 535
- Strobilus of Selaginella, 187
- Strohl, J., Adaptation of Ptarmigan to High Altitudes, 711
- Stroma-formation in *Xylaria Hypoxylon*, 483
- Strubell, —, Tuberculo-opsonic Index in Man and in Cattle, 363
- Strubell, A., Immunity of Hedgehog, 448
- Structure of Seed Plants, Reproduction. See CONTENTS
— — — — — Vegetative. See CONTENTS
- Stupefying Marine Animals, Use of Magnesia, 246
- Subcuticula and Lateral Areas of Nematodes, 170
- Suctoria, New, 326
— Notes, 179
- Suctorial Disc of Echeuis, 301
- Sudhoff, E., Action of Hydrogen and Nitrogen on Temper-carbon in Iron, 789
- Sulphur and Silicon, Effect on Cast-iron, 678
— and Tellurium, Mixed Crystals, 262
- Sulphur-flora of Lemberg, 478
- Summers, S. L. M., Antipatharians from the Indian Ocean, 269, 273
- Sunner, F. B., Somatic Modifications in White Mice, and their Reappearance in the Offspring, 706
- Sunfish, Structure of Bone, 708
- Surface, F. M., Cumulative Effect of Selection, 560
— Fertility and Hatching of Eggs, 555
— Use of Selection Index Numbers in Breeding, 296
- Surface-flow in Calcite, 123
- Suspensor in Helminthostachys, 596
- Suzuki, B., Improved Method of Dehydration, 249
- Svabenik, J., Structure of Gordius, 317
- Swellingrebel, N. H., Studies of Trypanosomes, 180
- Swinden, T., Carbon-tungsten Steels, 391
- Sycon raphanus*, Development, 324
- Sykes, M. G., Apogamy in *Pteris droogmantiana*, 470
— Cones of Selaginella, 598
- Symbiosis between Algae and Sponges, 480
— exhibited by a Ciliated Infusorian, 41
- Synapsis in *Thysanozoon brocehi*, 171
- Synaptic Phase, Phenomena, 154
- Synchytium, Mitosis, 43
- Syphilis, Infection of Rabbits and Guinea-pigs, 181
- System, Cu₂S-FeS, 261
- Systems: Tin-sulphur, Tin-selenium, Tintellurium, 261
- Szafer, W., Sulphur-flora of Lemberg, 478

T

- Table Demonstration, Bacteriological, 761
- Tactile-cells of Grandry's Corpuseles, 445
- Tadpoles, Experiments, 557
- Tænioma, 349
- Tafner, H., Drawing on a Transparent Drawing-surface, 517
- Tagueeff, G., Homogeneity of Metals, 529
- Tabara, M., Oospheres in Sargassum, 69
- Tait, J., Agglutination of Blood Corpuseles in Gammarus, 313
— Blood-coagulation in Gammarus, 719
— Coagulation of Blood in Arthropoda, 574
— Colour Change in Ligia, 719
- Takeda, H., Japanese Lycopodiales, 191
- Talitrus, Terrestrial Species from Victoria, 34
- Tammann, G., Effect of Compressing Mixtures of Metals, 388
— Magnetic Properties of Alloys of Ferromagnetic Metals, 264
- Tapeworms of North American Birds, 319
— of Red Grouse, 172
- Taphrina, Species on Betula, 75
- Tarapani, H., Development of Hyobranchial Skeleton in *Salamandra atra* and *Triton alpestris*, 152
- Tardigrada, Studies, 173
— Swiss, 33
- Tarnani, J. C., Luminescence in Chironomus, 31
- Tatu, Placentation, 153
- Tauret, C., Relations between Callose and Fungose, 751
- Tavanti, G., Copper-tin Alloys, 119
- Technique. See CONTENTS
- Tedeschi, A., Simple Anaerobic Methods, 374
- Teeth and a Lantern in Echinoneus, 37
— Rostral, of Pristis, 301

- Teleost, Embryos, Intermediary Mesodermic Mass, 18
- Teleosteans, Kidney, 449
- Olfactory Organ, 160
- Tensor Muscle of Choroid, 449
- Teleosts, Development of Heart, 18
- Teleost rosea*, 585
- Tellurium and Sulphur, Mixed Crystals, 262
- Temnocephala fasciata*, Hardening and Imbedding the Eggs, 114
- Temper-carbon, in Iron, Action of Hydrogen and Nitrogen, 789
- Temperatures of Camels, Diurnal Variations, 22
- Tench, Larva of *Echinorhynchus*, 37
- Two New Parasites, 42
- Tentacle-like Processes on *Opalina dimidiata*, 41
- Tentacular Anomaly in *Chromodoris elegans*, 566
- Termites and Fungus-culture, 79
- Terpineol for Microscopic Purposes, 523
- Terry, E. M., Effect of Temperature upon the Magnetic Properties of Electrolytic Iron, 680
- Tertiaries of *Coscinotiliscus asteromphalus*, on the Visibility of, in a Balsam Mount, 147, 270
- Testing by Alternating Stress, 124
- Screws, Method, 767
- Tetrabothrius, Structure, 172
- Tetraplatia, 728
- Tetrarhynchus unionifactor*, Endogenous Multiplication, 723
- Tetracotyle, New, from Brain of Minnow, 459
- Thallophyta. See CONTENTS
- Theobald, F. W., Pests of the Hop, 33
- Thériot, I., Bryophytes of New Caledonia, 613
- *Heterocladium Macounii*, 474
- F. Renauld, 739
- Thermometer, Nitrogen, 265
- Thermophilic Bacilli, New Species, 500
- Thiele, J., Revision of Chitons, 162
- Thom, C., Culture Studies of Species of *Penicillium*, 625
- Thomas, H. H., Assimilating-tissue of Fossil Ferns (Calamites), 596
- Thompson, E. I., *Tanioma*, 349
- Thompson, W. P., Phyletic Significance of Ray Tracheids in Coniferae, 731
- Thomson, D., Transmission of *Trypanosoma lewisi* by Rat-flea, 326
- Thomson, J. A., Hydrocoralline from Rockall, 324
- Indian Ocean Alcyonaria, 584
- — — Alcyonarians, 177
- Note on *Dendrobrachia fullax* Brook, a Rare and Remarkable Antipatharian, 142
- Study of Darwinism, 149
- Thorax of Insects and Articulation of Wings, 572
- Thymus, Degeneration and Regeneration in Modified Nutritive Conditions, 447
- in Rabbit, Involution, 150
- of Reptiles, 20
- Thyroid, Vestiges in *Chlamydoselachus* and Dogfish, 562
- Thysanoptera, New Genera, 167
- Thysanozoon brocchi*, Synapsis, 171
- Thysanura and Collembola of Midland Plateau, 572
- Tièche, —, Mites in Man, 455
- Tile, Dissecting, and Stand, 522
- Till, A., Beaks of Fossil Cephalopods, 25
- Tilletiæ, Notes, 208
- Timber-destroyer, *Coniophora cerebella*, 485
- Timofejew, D., New Method of Staining the Connective-tissue Framework of Viscera, 116
- Tims, H. W. M., Seal-embryos, 443
- Tin and Antimony, Influence on the Iron-carbon System, 679
- and Arsenic, Influence upon Iron, 262
- and Lead Alloys, 119, 260
- Phosphides, 388
- Tipulidæ, New, 452
- Tison, A., Plasmodiophoraceæ, 634
- Tissue, Storage, Stimulation by Zinc Sulphate, 47
- Titanium Alloys, Application in the Steel Industry, 792
- Toad, American, Habits, 300
- Origin of Blood, 556
- Toads, Hermaphroditism, 296
- Tobler, —, Mussels Settling in Gas-vesicle of Seaweed, 304
- Tobler, F., Epiphytes of Laminaria, 196
- *Saccorhiza bulbosa*, 348
- Tollinger, J., Alimentary Tract of Lynceus, 456
- Toluidin-blue, 786
- Tonsils, Minute Structure, 446
- Toppe, O., Cuidoblasts of Hydra, 176
- Study of Stinging Cells, 462
- Topsent, E., New Monaxonids, 324
- Torrend, C., Text-book of Mycetozoa, 220
- Torrey, H. B., Californian Species of *Cerianthus*, 463
- Differentiation and Growth in *Aglaophenia*, 463
- New Species of *Cerianthus*, 322
- Tortricidæ, Palearctic, 714
- Toruli Fungi, Study, 625
- Trabut, M., Origin of Cultivated Oats, 185
- Tracheæ in Araneæ, Phylogeny, 311
- Tracheids, Ray, Phyletic Significance in Coniferae, 731
- Trägårdh, I., New Phorid, 32
- Trail, J. W. H., *Lycopodium Selago*, a Curious Habitat, 597

- Transparent Zoological Specimens, 395
 Transpiration, 467
 Tranzschel, W., Uredineæ, 352
 — and another, Uredineæ, 627
 Trapp, —, Fixation of the Complement in Glanders, 87
 Trantmann, A., Musculature in Villi of Small Intestine, 153
 Travis, C., Behaviour of Crystals in Light Parallel to an Optic Axis, 657
 Travis, W. G., *Ceratodon conicus*, 608
 — Lancashire Hepatics, 610
 Traviss, W. R., Iris-diaphragm for High-power Objectives, 395
 Treasurer's Balance Sheet, 133
 Trécourt and Oberhaeuser, Old Achromatic Microscope, 640
 Trees, Age, and Branch Types, 591
 — Ascent of Sap, 594
 Trematode, New, from Frog, 459
 — — from Man, 37
 — Peculiar, of the Mole, 318
 Trematodes and Cestodes, Cuticula and Subcuticula, 318
 — Digenic, Relationships, 171
 Trentepohlia, 479
 Tretjakoff, D., Mesencephalic Nerve in Ammocetes, 161
 — and another, Study of Nervous Systems, 154
 Trichinosis in Posen, 36
 Trichomanes, Apospory and Apogamy, 187, 734
 Trichomonad with Four Anterior Flagella, 325
 Triclad, Australian, 318
 — Excretory System, 37
Trigonolys hahnii, Structure, 571
Triton alpestris and *Salamandra atra*, Development of Hyobranchial Skeleton, 152
Trochila Populorum, 623
Trochodota dunedinensis, 532
 Trojan, E., Luminosity of *Phyllirhoe bucephala*, 565
 Tropidonotus, Variations, 23
 Trouessart, E. L., New Insectivore, 157
 Trout, Sea, Icthyosporidian Disease, 181
 Truffi, M., Infection of Rabbits and Guinea-pigs with Syphilis, 181
 Truffles, Development, 482
 Trypanoplasma and Bodo, Transition Types, 181
 — and Cryptobia, 180
 — *congeri*, Division, 729
Trypanosoma dimorphon, Staining, 672
 — *lewisi* in Rat-louse, 41
 — — Transmission by Rat-flea, 326
 Trypanosome in Alimentary Tract of *Pontobdella muricata*, 326
 — in Edentate, 729
 — Nagana, Study, 464
 — New, 42
 Trypanosome, New, in a Vole, 326
 — of a Gecko, 326
 — of Lerot, 729
 Trypanosomes, etc., Examination of Blood for, 247
 — Influence of Ultra-violet Rays on, 464
 — Studies, 42, 180, 326, 465
 — Vital Staining, 384
 Trypanosomiasis in Man in Sumatra, 464
 Tschermak, A. v., Study of Heart-action in Fish Embryos, 160
 Tschourina, O., *Astrocladium cerastioides*, 202
 Tubercle Bacilli, Acid-fast and Granular Types, 500
 — — Detection in Fæces, 672
 — — — in Milk and Fæces, 782
 — — — in the Placenta, 785
 — — in the Blood, Demonstrating, 673
 — — Media which Attenuate or Exalt the Virulence, 86
 — — New Staining Reaction, 117
 — Bacillus, Cultivation upon Animal Tissues, 375
 — — New Type, 501
 Tuberculosis in Cold-blooded Animals, 501
 — in Salt-water Fish, 497
 Tubers of *Polypodium Brunci*, 734
 Tullgren, A., Studies on Aphides, 167
 Tumelle, H., Clusiaceæ of North-west Madagascar, 732
 Tunicata, Antarctic, 302
 — See CONTENTS
 Tunicate, Study, 450
 Tunicates, Australian, 25
 Turbellarian, New Type, 318
 Turbellarians from the Gulf of Trieste, 318
 — North American, 582
 — Parasitic, 582
 Turner, T., Copper-zinc Alloys, 675
 Turnips, Bacterial Rot, 499
 Tutton, A. E., Standard Measurement in Wave-lengths of Light, 235
 — Use of Wave-length Rulings as Defining Lines on Standards of Length, 107
 — Wave-length Comparator for Standards of Length, 107
 Twiss, E. M., Prothallia of Aneimia and Lygodium, 337
 Tylenchus, Species in Moss, 458
 Tympanum, Innervation, 151
 Types, Specific, versus Formenreihen, 613
 Typhus Fever, Bacillus, 638
 — Flies as Disseminators, 716
 Tyrosinases, Vegetable, Resistance to High Temperatures, 751

U

- Uhlenhuth, P., and others, New Methods for Examining Sputum, 252
- Ulbrich, E., New Variety of the Common Ophioglossum, 338
- Ultramicroscopic Cinematography of Living Microbes, and of Moving Particles, 100
- Examination of Colours of Textile Fibres, 770
- — of Liquids during Electrolysis, 658
- Image, 515
- Ultra-microscopical particles, Zeiss' Microscope for Investigating, 91
- Ultramicroscopy and Dark-field Illumination in Biology and in Medicine, 367
- Recent Progress, 654
- Undaria, Mucilage-glands, 68
- Underwood, L. M., and others, North American Fern-flora, 51
- Unionidæ, Postembryonic Development, 164
- Upogebia stellata* and *Gebia deltura*, 456
- Urasow, G. G., Aurides of Magnesium, 261
- Uredinaceæ, New Genus, 748
- Uredineæ, 76, 208, 352, 484, 627, 747
- Deformations caused by, 209
- Uredospores of *Hemileia vastatrix*, Germination, 626
- Urnula Geaster*, Systematic Position, 350
- Urodela, Ribs, 159
- Urogenital Organs of *Chimæra monstrosa*, 711
- Urophlyctis Alfalfæ*, 350
- Ussoff, S. A., Significance of the Entochorda, 157
- Ustilago bulgarica*, 485
- Utricularia, 183
- V
- Vagi, Role in Development of Sympathetic Nervous System, 295
- Vahle, C., Comparative Studies of the Myxobacteriaceæ and the Bacteriaceæ, 88
- Vallilo, G., *Ascaris mystax* in Lion, 36
- Vanadium, Manganese and Chromium, Magnetic Properties, 526
- Vandendries, R., Studying the Development of Crucifera, 256
- Vaney, C., Caterpillars of *Epichnopteryx helicinella*, 570
- Development of Eggs of Silk-moth, 305
- New Method of Fixing Plankton, 375
- Vitellus in Silk-moth's Eggs, 30
- Vascular and Cœlomic Systems in Loligo, Development, 161
- Vaucheria, 617
- *synandra*, 347
- Vay, F., Granules of Plague Bacilli, 86
- Vayssièrè, A., Double Egg in Porbeagle Shark, 294
- New Family of Æolididæ, 26
- — Genus of Nudibranchs, 566
- Tentacular Anomaly in *Chromodoris elegans*, 566
- Vegetable Matter, Balls of, from Sandy Shores, 49
- Pigments, 786
- Vegetation of the Upper Rhine, 741
- Venator, W., Application of Titanium Alloys in the Steel Industry, 792
- Venous System of the Lauprey, 564
- Verderame, P., Gram-negative Cocci from the Human Conjunctiva, 636
- Veretillum cynomorium*, Movements and Sensory Reactions, 38
- Verhoeff, K. W., Studies on Isopods, 314
- Vernon, R. D., *Schizoneura paradoxa*, 596
- Verrill, A. E., Notes on North American Starfishes, 174
- Vertebral Column in Grass Snake, Development, 151
- Vertebrata, Origin, 447
- Studying the Finer Structure of the Labyrinth, 113
- See CONTENTS
- Vertebrates, Higher, Motor End-plate, 153
- New Methods of Investigating Central Nervous Systems, 249
- Temporal Region, 157
- Vesicular Secretion, 155
- Viala, P., Vine Roesleria, 623
- Vibrios, Cholera, in Peptone Solutions of Different Reactions, Morphology, 364
- Vibrissæ on Cats' Arm, 157
- Vielmeyer, H., and another, Myrmecophilous Caterpillars, 714
- Vigouroux, E., Alloys of Nickel and Copper, 387
- Viguièr, C., Precocious Maturity of Larval Spionid, 721
- Villi of Small Intestine, Musculature, 153
- Vine Roesleria, 623
- Viper's Poison, Immunity of Lerot, 22, 710
- Viret, L., Alge of Haute-Savoie, 203
- Desmids, 201
- Virieux, J., Sheath and Mucilage of Fresh-water Algæ, 740
- Visibility of the Tertiaries of *Coccolodiscus asteromphalus*, 270
- Vitality of Spores, 491
- Vitelline Membrane in Egg of Birds, 293
- Vitellus in Silk-moth's Eggs, 30
- Vittariæ, Relationships of the Genera, 600
- Vlès, F., Noises made by Snail on Window-pane, 303
- Voeltzkovia mira*, Integument, 297
- Vogel, R., Ternary System Iron-copper-nickel, 677
- Voges, E., Systematic Study of Hender-sonia, 625

Vole, New Trypanosome, 326
 Volvocaceæ, 346
 Vorländer, D., Axial Images of Fluid-crystals, 658
 Vuillemin, P., Classification of Hyphomycetes, 351

W

- Waddell, C. H., George Stabler and J. M. Barnes, 477
 Wager, H., and another, Cytological Observations on the Yeast Plant, 207
 Waggoner, C. W., Effect of Low Temperature on Iron-carbon Alloys, 791
 Wahl, B., Parasitic Turbellarians, 582
 Wahl, W., Cobalt-gold Alloys, 525
 Wainio, E. A., Siberian Lichens, 85
 Wakefield, E., Experiments on Higher Fungi, 353
 Walcott, C. D., Penellus and other Mesonacidae, 718
 Walker, A. O., *Hippolyte gracilis* in the British Area, 168
 Walker, W. H., Testing of Galvanised Metals, 124
 Wallin, I. E., Genus *Allocreadium*, 581
 Wanjukoff, W., Microstructure of Copper, 387
 Ward, H. B., Fasciolopsis, 581
 Warming, E., Saxifragaceæ, 330
 Warren, E., Hydroid Parasitic on Hydroid, 39
 Washing Apparatus for Fixed Material, 250
 Waterson, D., Development of Penguin, 444
 Watkinson, G. B., So-called Olfactory Organ in Cephalopods, 302
 Watson and Sons' "Advanced" Petrological Microscope, 506
 — — — Holos Immersion Paraboloid, 231
 — — — Parachromatic Objectives, 651
 — — — "Royal Microscope," 646
 Watsons' Naturalist's Microscope, 224
 — $\frac{1}{8}$ and $\frac{1}{12}$ Objectives, 226
 Wattam, W. E. L., *Hymenophyllum peltatum* in Yorkshire, 601
 Wave-length Comparator for Standards of Length, 107
 — Rulings, Use of, as Defining Lines on Standards of Length, 107
 Wave-lengths of Light, Standard Measurement in, 235
 Weatherby, C. A., American Forms of *Lycopodium complanatum*, 603
 Wedekind, E., Magnetic Character of Compounds of Non-magnetic Elements, 264
 Wehrli, —, Acid-fast and Granular Types of Tubercle Bacilli, 500
 Weinert, H., Physiology of Liverwort-rhizoids, 54
 Weiss, A., Australian Triclad, 318
 Weiss, P., Magnetic Properties of Manganese, Vanadium, and Chromium, 526
 Weissenbach, J. S., Cementation by Gases, 791
 Weitlauer, F., Luminosity of Glow-worm, 166
 Welch, F. D., Change of Colour in a Ratel, 448
 Weltner, W., Nature of Astrosclera, 728
 Wentz, O. W., Transparent Zoological Specimens, 395
 Wenyon, C. M., Observations on a Flagellate of the Genus *Cercomonas*, 660
 Werner, E., *Ceratium hirundinella*, 478
 Werner, H., *Spirochæta eurypyrrata* and *S. stenopyrrata*, 86
 Wernham, H. F., Morphology of Phylloglossum, 468
 Wesché, W., 267, 304
 — Larvæ and Pupæ of West African Culicidæ, 716
 — Quick Method of Preparing and Staining Pollen, 380
 — Viviparity in *Phorocera serriventris* and other Flies, 165
 West, G. S., *Hullhousia mirabilis*, 87
 West, W., Some Fresh-water Algæ of Fiji, 66
 — and G. S., Phytoplankton of the English Lake District, 63
 Wester, D. H., Distribution of Chitin, 298
 — Study of Chitin, 44
 Wheat Midge, Tenby, Notes on, and Life-history of the Hessian Fly, 127
 Wheat-seedlings, Chemical Reagents in Relation to, 334
 Wheldale, M., Inheritance of Flower-colour in *Antirrhinum majus*, 336
 — Physiological Interpretation of Flower-colour, 337
 Wheldon, H. J., Key to the British Agaricaceæ, 749
 Wheldon, J. A., Additions to the Maun Sphagna, 610
 — Lancashire Mosses, 341
 — New Lancashire Cryptogams, 745, 756
 — — — Mosses, 609
 — Scotch Bryophyta, 475
 Whetting a Microtome Knife, Apparatus, 253
 White, B., Observations on certain Lactic Acid Bacteria of the so-called Bulgaricus type, 89
 White, J., Ferments and Latent Life of Resting Seeds, 48
 White, W. P., Determination of Melting-points, 264
 Widakowich, —, Method of Examining Embryos from the Maternal Tissues of the Rat, 246
 Widakowich, V., Early Stages in Development of Rat, 442

- Widdringtonia, Ovule, Gametophytes and Embryo, 46
- Widmanstätten Figures. Artificial Reproduction, 791
- Wieland, G. R., Williamsonias of *Mixteca alta*, 335
- Wiesner J., Change in Direct Sunlight during its Passage through Foliage, 333
- Wietrzykowski, W., Development of Lucernarids, 38, 585
- Wijnhoff, G., Structure of Cephalothrix, 725
- Wildeman, E. de, Ferns of the Congo, 52
- Will, L., Development of Nematocysts, 462
- Wille, N., *Himantalia lorea*, 618
— Supplement to Engler's Pflanzenfamilien, 200
- Willems, J., Spermatogenesis in *Alytes obstetricans*, 152
- Willey, A., Association of Barnacles with Snakes and Worms, 721
- Williams, R. S., Bolivian Mosses, 59
- Williamsonias of *Mixteca alta*, 335
- Wills, L. J., *Schizoneura paradoxa*, 596
- Wiltmore, L. J., Zoanthæa from Queensland and New Hebrides, 176
- Wilson, A., Scotch Bryophyta, 475
- Wilson, H. L., New Parasite on *Gracilaria confervoides*, 619
- Wilson, J., Inheritance of Quantity and Quality in Cows' Milk, 704
- Wilson, M., Spermatogenesis of Mnium, 192
- Winge, O., Mycological Notes, 629
- Winiwarter, H. V., Structure of Mammalian Ovary, 17
- Winkel's Microscopes, 804
- Winter, —, Some Critical Species of Pohlia, 60
- Winter, H., and another, Norwegian Mosses, 343
- Wintrebert, P., Palatine and Pterygoid Bones in Axolotl, 301
— Transformation of Palatal Region in Axolotl, 301
- Withers, T. H., New Fossil Barnacles, 315
- Wolf, F. A., Systematic Position of *Urnula Geaster*, 350
— Whitening of the Mountain Cedar, *Sabina sabinoïdes*, 746
- Wolff, A., Microfungi in Cheese Curds, 212
- Wolffian and Müllerian Ducts in Rodents, Development, 150
- Wologdine, S., Phosphides of Iron, 262
- Woltereck, A., New Amphipods from Eastern Tropical Pacific, 34
- Women Fellows, Notice of Alteration of By-Laws to confer full privileges on, 128
- Wood Structure in Pineæ, 44
- Woodruff, L. L., Life-cycle of Paramecium, 179
- Worm, Pearl-inducing, Adult of, 723
- Worms and Snakes, Association of Barnacles with, 721
- Woronichin, N. N., Black Sea Algæ, 621
- Worsdell, W. C., Rhizophore of Selaginella, 599
- Woycicki, Z., Laboratory Cultures under Gas, 197
- Wright, F. E., New Petrographic Microscope, 502
— — — Ocular, 508
- Wright, J. H., Staining Blood Platelets, 783
- Wright, J. P., Tobacco Beetles, 165
- Wuist, E. D., Culture of Fern Prothallia, 600
— Monœcious Prothallia in Onoclea, 338
- Wunderer, H., Printing on Sensitized Papers, 765
- Wüst, F., Action of Hydrogen and Nitrogen on Temper-carbon in Iron, 789
— Shrinkage of Metals and Alloys, 388
— and another, Iron-carbon Diagram, 121
- Wyss, O., Autumnal Iridescence of Lakes, 314

X

- Xylander, —, Relation of the Ratinbacillus to the Bacilli of the Gaertner Group, 89
- Xylaria Hypoxylon*, 350
— — Stroma-formation, 483
- Xylem, Centripetal, in Equisetum, 50

Y

- Yakimoff, W. L., Piroplasma of Hedgehog, 180
- Yamamoto, J., Locomotion of Protists, 465
- Yamanouchi, S., Chromosomes in *Osmunda*, 187, 330
— Cytology of Cutleria and Aglaozonia, 69
- Yatsu, N., Cleavage of Ctenophore Ovum, 585
— Egg of *Cerebratulus*, 724
— Experiments on Cleavage of *Cerebratulus* Ovum, 582
— Ookinosis in *Cerebratulus lacteus*, 320
- Yeast, Functions, 625
— Fungus, Assimilation of Nitrogen, 486
— Plant, Cytological Observations, 207
— Red, 747
— Researches, Critical Notes, 483
- Yeast-cells, Fusion, 624
— Notes, 747
— of *Endomyces albicans*, 625
- Yeast-spores, Method of Obtaining, 520
- Yeasts, Cytology, 351

Yeasts, Notes on Phylogenesis, 75
 Yendo, K., Asexual Mode of Auxospore
 Formation, 615
 — Mucilage-glands of *Undaria*, 68
 Young, M. S., Morphology and Relation-
 ships of the Podocarpineæ, 731
 Youngman, W., Abnormal Reproductive
 Organs in Frog, 19
 Yurisch, A., Numbering Celloidin Sec-
 tions, 782

Z

- Zach, F., Mycorrhiza of *Sempervivum*, 216
 Zahlbruckner, A., Lichens from Brazil,
 218
 — New Lichens, 84
 Zalessky, M. D., New Fossil *Dadoxylon*,
 192
 Zander, E., Study of the Honey-bee, 568
 Zehnder, L., New Half-shadow Polari-
 meter, 227
 Zeiss' Microscope for Investigating Ultra-
 microscopical Particles, 91
 Zemezuzny, S., Alloys of Lead with Indium
 and Thallium, 261
 — Phosphorus Compounds of Cobalt, 261
 Zempten, —, Ferments of Fungi, 212
 Zielinska, J., Regeneration in *Lumbricidæ*,
 315
 Zielinski, F., Biology of the Archegonium
 and Calyptra, 54
- Zikes, H., Assimilation of Nitrogen by
 Yeast Fungus, 486
 — Bacterial Parasites of Barley, 637
 Zimmermann, C., Catalogue of Portuguese
 Diatoms, 347
 — Diatoms of Madeira and Porto Santo,
 347
 Zimmermann, K. W., Structure of Heart
 Muscle, 297
 Zinc Alloys, 260
 — — with silver, 260
 — Amalgams, 676
 — Bronzes, 677
 — Sulphate, Stimulation of Storage Tissue,
 47
 Zinnia, Variation due to Traumatism,
 185
 Zoanthæ from Queensland and New
 Hebrides, 176
 Zoology of Ruwenzori, 161
 Zoanthallæ, Entry into Ovum of Mille-
 pora, 463
 Zopf, —, Chemistry of Lichens, 85
 Zsacke, H., Lichen Flora of the Saal
 Valley, 218
 Zschokke, B., Effect upon Steel of Sudden
 Changes of Temperature, 391
 — Homogeneity of Optical Glass, 244
 Zürcher, L., Musculature of *Owenia*,
 169
 Zygopteridæ and Osmundaceæ, Fossil,
 596
Zygopteris Grayi, 471

*Erratum on p. iv, PAST-PRESIDENTS—
 for 1909-10 read 1909*

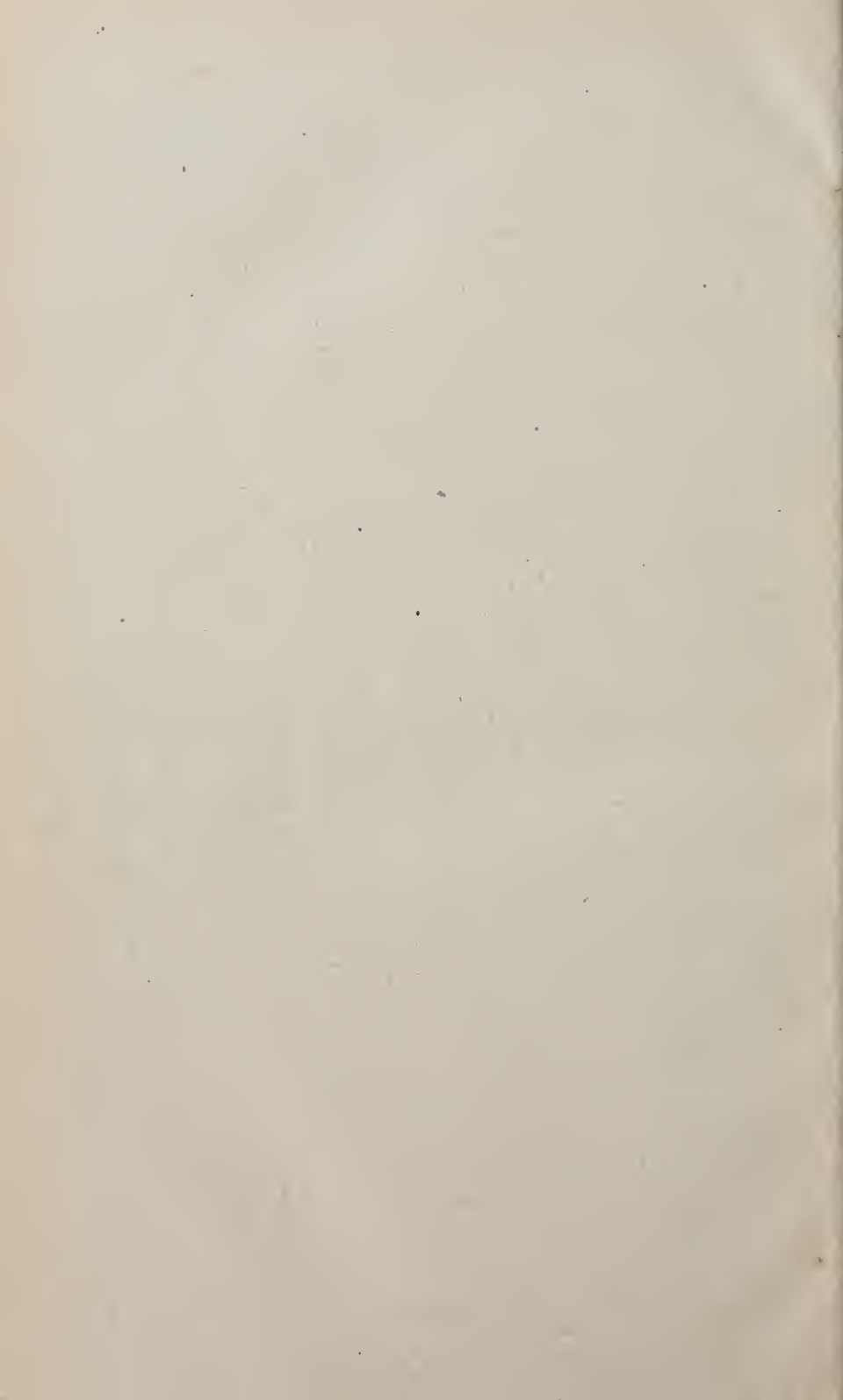

WH 18WF J

255

